



Model created in COMSOL Multiphysics 6.4

Disk-Stack Heat Sink

Introduction

This example studies the cooling effects of a disk-stack heat sink on an electronic component. The heat sink shape (see [Figure 1](#)) shows several thin aluminum disks piled up around a central hollow column. Such a configuration allows cooling of large surfaces of aluminum fins by air at ambient temperature.

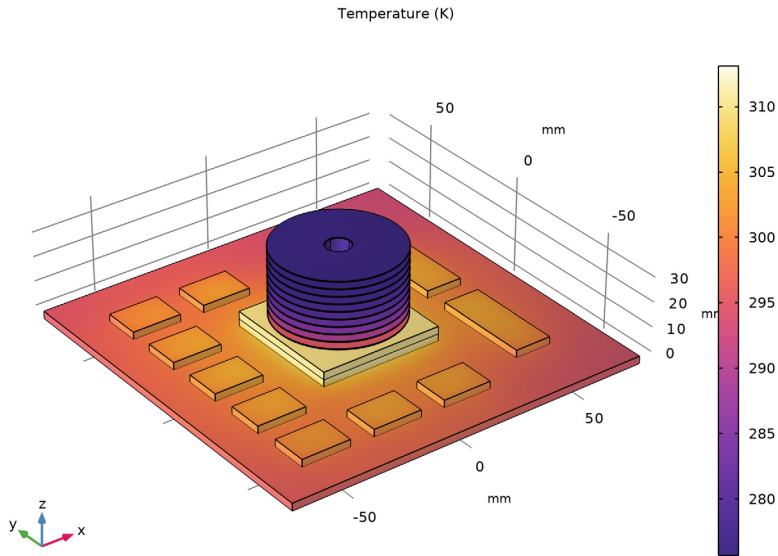

Figure 1: Steady-state surface temperature distribution of the electronic device.

To evaluate the efficiency of the heat sink, this tutorial follows a typical preliminary board-level thermal analysis. First, a simulation of the board with some Integrated Circuits (ICs) is performed. Then, the disk-stack heat sink is added above the main hot electronic component to observe cooling effects. The final part adds a copper layer to the bottom of the board in order to obtain a more uniform temperature distribution and see how it affects the heat transfer in the circuit board.

This exercise highlights a number of important modeling techniques such as combining 3D solids and shells and using thin layer boundary conditions when replacing 3D thin geometries by 2D boundaries.

GEOMETRY

Figure 2 shows that the first studied geometry is made of a circuit board with several ICs on it.

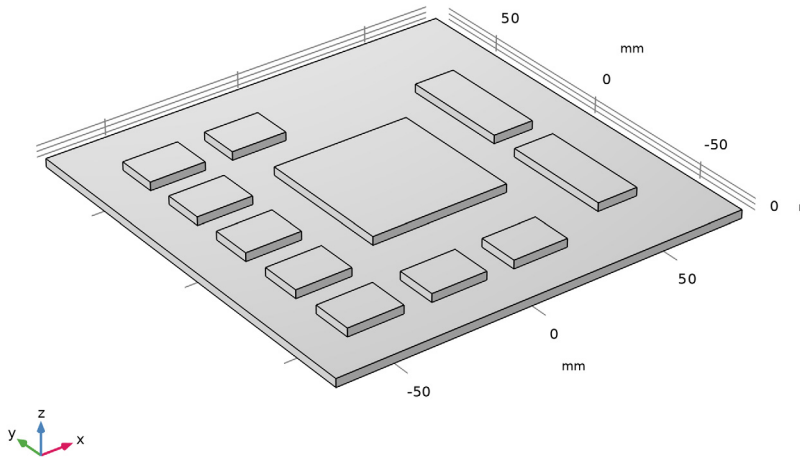

Figure 2: First geometry without heat sink.

This typical board-level thermal analysis determines the temperature profile in and around a high-power chip. The printed-circuit board usually consists of multiple layers of FR4 material (Flame Resistant 4) and copper traces along the board. Hence, the thermal conductivity along the board is much higher than the conductivity through it. It is possible to take several approaches for simulating such a board in COMSOL Multiphysics. This example uses a macro-level approach and assumes a homogeneous PC board with anisotropic thermal material properties. In this case, heat diffusion through the board and natural convection with the ambient air are insufficient to adequately cool the chip. Hence, a disk-stack heat sink is required to increase the effective cooling area for the chip.

REGARDING MATERIALS

The IC packages and the PC board on which they are mounted must be defined. In reality, these components have very detailed structures and are made of a variety of materials. For

a board-level analysis such as the present one, though, it is much simpler to lump all these detailed structures into single homogeneous materials for each component, instead of accounting for the thermal characteristics of a multilayer PC board, which typically consist of multiple layers of FR4 (insulator) interspersed with layers of copper traces. The thermal result of this construction is that the thermal conductivity along the board is considerably higher than through it. Physical property values depend on the number of layers, how dense the lines are, and how many vias (interconnections between layers) per unit area are present. The model uses an estimate for a highly layered board, so that it creates a strong difference in conductivity between the printed-circuit board plane (x, y) and the orthogonal direction z . Those properties are presented in Table 1. The units are $W/(m \cdot K)$ for thermal conductivity, kg/m^3 for density and $J/(kg \cdot K)$ for heat capacity.

TABLE 1: MATERIALS PROPERTIES.

MATERIALS	CONDUCTIVITY	DENSITY	HEAT CAPACITY
Copper	400	8700	385
FR-4	0.3	1900	1369
Aluminum	160	2700	900
IC Packages (Silica Glass)	1.38	2203	703
PC Board (x, y , and z directions)	{80, 80, 0.3}	1900	1369

THERMAL CONFIGURATION

In this problem the large central chip dissipates 20 W, the array of smaller chips are 1 W each, and the two elongated chips are 2 W each. The volumetric heat source is calculated by dividing the heat power by the volume of the considered IC.

In this example, you assume that a fan cools the board, and specify a convective heat transfer coefficient for the boundary heat flux. Here, you look for a preliminary sizing calculation and simply assume a convective coefficient, h , of $20 W/(m^2 \cdot K)$. This corresponds to a fan blowing air at approximately 1 m/s on a plate. The air temperature is set to $T_0 = 273.15$ K during the whole modeling process.

Without a heat sink, the temperature rise in the main chip is higher than the maximum operating temperature. A stacked disk heat sink increases the effective area and therefore cools the chip further. This heat sink consists of a series of thin disks supported by a central hollow column that is mounted to the chip with an aluminum base corresponding to the size of the chip. The heat sink is mounted dry and must therefore account for contact

resistance. Figure 3 shows the new geometry with the main chip equipped with the heat sink.

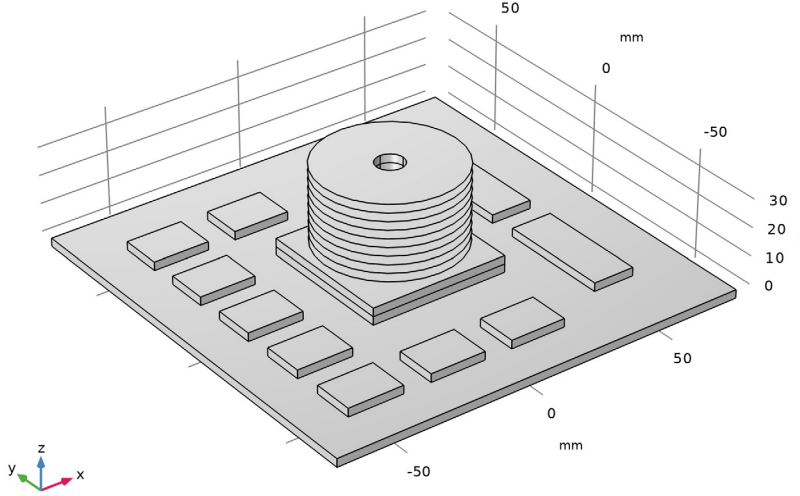

Figure 3: Full geometry of the PC board equipped with the heat sink.

Thermal linkage between the IC and the added heat sink is made using the **Thermal Contact** boundary condition. It provides a heat transfer coefficient at the two surfaces in contact according to (1.9 in Ref. 1):

$$h_{\text{interface}} = h_{\text{constriction}} + h_{\text{gap}} = 1.25k_s \frac{m}{\sigma} \left(\frac{p}{H_c} \right)^{0.95} + \frac{k_{\text{gap}}}{Y + M_{\text{gap}}}$$

This expression involves two parameters related to the surface microscopic asperities: σ , the average asperities height, and m , the average asperities slope. In this case, σ and m are set to $1 \mu\text{m}$ and 0.5 , respectively. The microhardness of the softer material, H_c , is here the hardness of aluminum, equal to 165 MPa . The contact pressure, p , is set to 20 kPa . The thermal conductivity k_{gap} is related to the material in the interstitial gap, here assumed to be air at atmospheric pressure. It is equal to $0.025 \text{ W}/(\text{m}\cdot\text{K})$.

A design value of 0.3 mm is chosen for the thickness of the fins and the central hollow column.

Finally, the last part explores the possibility of evening out the temperature distribution across the PC board. For instance, add a 0.4 mm layer of copper across the entire bottom surface of the board. The previous section does not suggest much success for this approach. However, it is interesting to check such an analysis for the sake of comparison. In COMSOL Multiphysics, this is easily done using the **Thin Layer** boundary condition.

Results and Discussion

Figure 4 shows the stationary temperature field on the surfaces of the board and chips in kelvin. The central region of the IC becomes rather hot (337 K) and needs extra cooling.

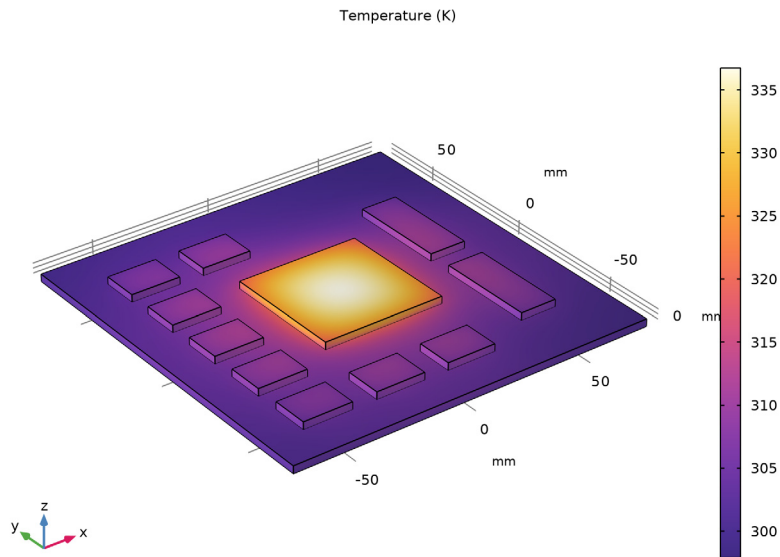

Figure 4: Temperature distribution of the PC board without the heat sink.

As Figure 5 shows, there is a steep thermal gradient between the IC and the heat sink base which is caused by the contact resistance and the significant cooling by the heat sink fins.

The maximum device temperature has now dropped to 313 K, which is 24 K lower than without the heat sink.

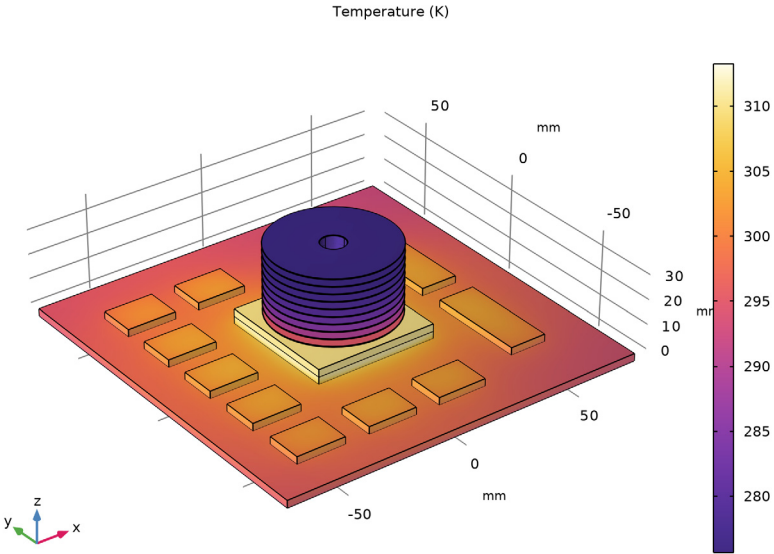

Figure 5: Temperature distribution of the PC board with its heat sink.

Finally, Figure 6 shows that adding a layer of copper at the bottom of the Circuit Board is ineffective. This phenomenon agrees with the fact that the Circuit Board material has a rather poor thermal conductivity along the vertical z -axis (orthogonal to the PC plane).

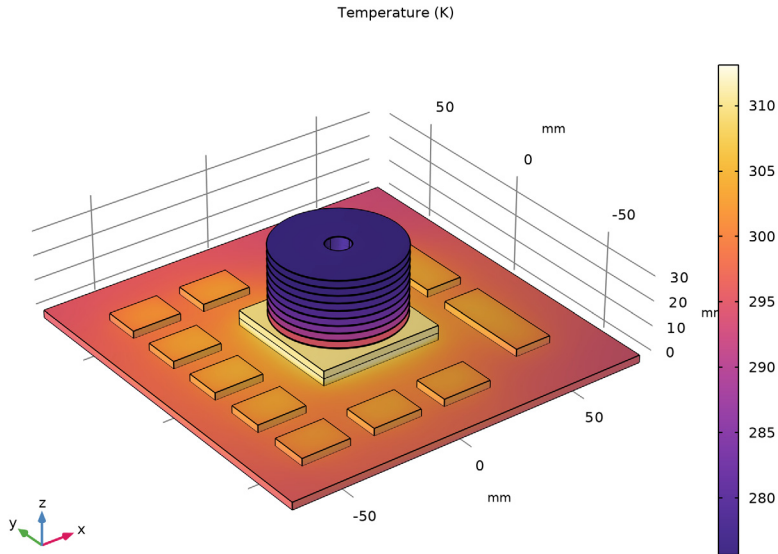

Figure 6: Temperature distribution of the PC board with its heat sink and a layer of copper at bottom

Notes About the COMSOL Implementation

In this application, use the Heat Transfer in Thin Shells interface to model thermal behavior of fins. The number of elements is significantly reduced because, instead of creating a thin 3D geometry, only a 2D layer is meshed.

References

1. A.D. Kraus and A. Bejan, *Heat Transfer Handbook*, John Wiley & Sons, 2003.

Application Library path: Heat_Transfer_Module/
Thermal_Contact_and_Friction/disk_stack_heat_sink



Modeling Instructions

From the **File** menu, choose **New**.

NEW

In the **New** window, click  **Model Wizard**.

MODEL WIZARD

- 1 In the **Model Wizard** window, click  **3D**.
- 2 In the **Select Physics** tree, select **Heat Transfer > Heat Transfer in Solids (ht)**.
- 3 Click **Add**.
- 4 Click  **Study**.
- 5 In the **Select Study** tree, select **General Studies > Stationary**.
- 6 Click  **Done**.

GLOBAL DEFINITIONS

Parameters I

- 1 In the **Model Builder** window, under **Global Definitions** click **Parameters I**.
- 2 In the **Settings** window for **Parameters**, locate the **Parameters** section.
- 3 Click  **Load from File**.
- 4 Browse to the model's Application Libraries folder and double-click the file `disk_stack_heat_sink_parameters.txt`.

GEOMETRY I

- 1 In the **Model Builder** window, under **Component 1 (comp1)** click **Geometry 1**.
- 2 In the **Settings** window for **Geometry**, locate the **Units** section.
- 3 From the **Length unit** list, choose **mm**.

Block 1 (blk1)

- 1 In the **Geometry** toolbar, click  **Block**.
- 2 In the **Settings** window for **Block**, locate the **Size and Shape** section.
- 3 In the **Width** text field, type `CB_w`.
- 4 In the **Depth** text field, type `CB_l`.
- 5 In the **Height** text field, type `CB_t`.
- 6 Locate the **Position** section. In the **x** text field, type `-CB_w/2`.

7 In the **y** text field, type $-CB_1/2$.

8 In the **z** text field, type $-CB_t$.

9 Click  **Build Selected**.

Block 2 (blk2)

1 In the **Geometry** toolbar, click  **Block**.

2 In the **Settings** window for **Block**, locate the **Size and Shape** section.

3 In the **Width** text field, type $IC1_w$.

4 In the **Depth** text field, type $IC1_1$.

5 In the **Height** text field, type $IC1_t$.

6 Locate the **Position** section. In the **x** text field, type $-CB_w/2+IC1_w$.

7 In the **y** text field, type $-CB_1/2+IC1_1$.

8 Click  **Build Selected**.

Block 3 (blk3)

1 In the **Geometry** toolbar, click  **Block**.

2 In the **Settings** window for **Block**, locate the **Size and Shape** section.

3 In the **Width** text field, type $IC2_1$.

4 In the **Depth** text field, type $IC2_w$.

5 In the **Height** text field, type $IC2_t$.

6 Locate the **Position** section. In the **x** text field, type -60 .

7 In the **y** text field, type -60 .

8 Click  **Build Selected**.

Copy 1 (copy1)

1 In the **Geometry** toolbar, click  **Transforms** and choose **Copy**.

2 Select the object **blk3** only.

3 In the **Settings** window for **Copy**, locate the **Displacement** section.

4 In the **x** text field, type $0\ 0\ 0\ 0$ range(30,30,60) 30.

5 In the **y** text field, type $range(25, 25, 100)\ 0\ 0\ 100$.

6 Click  **Build Selected**.



Block 4 (blk4)

1 In the **Geometry** toolbar, click  **Block**.

2 In the **Settings** window for **Block**, locate the **Size and Shape** section.

- 3 In the **Width** text field, type IC3_w.
- 4 In the **Depth** text field, type IC3_1.
- 5 In the **Height** text field, type IC3_t.
- 6 Locate the **Position** section. In the **x** text field, type 40.
- 7 In the **y** text field, type -50.
- 8 Click  **Build Selected**.

Copy 2 (copy2)

- 1 In the **Geometry** toolbar, click  **Transforms** and choose **Copy**.
- 2 Select the object **blk4** only.
- 3 In the **Settings** window for **Copy**, locate the **Displacement** section.
- 4 In the **y** text field, type 50.
- 5 In the **Geometry** toolbar, click  **Build All**.

DEFINITIONS

ICs, Type 1

- 1 In the **Definitions** toolbar, click  **Explicit**.
- 2 In the **Settings** window for **Explicit**, type ICs, Type 1 in the **Label** text field.
- 3 Select Domain 9 only.

It might be easier to select the correct domain by using the **Selection List** window. To open this window, in the **Home** toolbar click **Windows** and choose **Selection List**. (If you are running the cross-platform desktop, you find **Windows** in the main menu.)

ICs, Type 2

- 1 In the **Definitions** toolbar, click  **Explicit**.
- 2 In the **Settings** window for **Explicit**, type ICs, Type 2 in the **Label** text field.



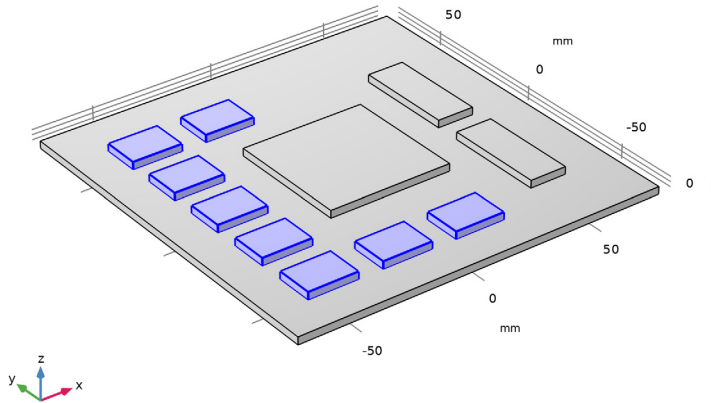

3 Select Domains 2–8 and 10 only.



ICs, Type 3



- 1 In the **Definitions** toolbar, click  **Explicit**.
- 2 In the **Settings** window for **Explicit**, type ICs, Type 3 in the **Label** text field.
- 3 Select Domains 11 and 12 only.

ICs

- 1 In the **Definitions** toolbar, click  **Union**.
- 2 In the **Settings** window for **Union**, type ICs in the **Label** text field.
- 3 Locate the **Input Entities** section. Under **Selections to add**, click  **Add**.
- 4 In the **Add** dialog, select **ICs, Type 1** in the **Selections to add** list.
- 5 Click **OK**.
- 6 In the **Settings** window for **Union**, locate the **Input Entities** section.
- 7 Under **Selections to add**, click  **Add**.
- 8 In the **Add** dialog, select **ICs, Type 2** in the **Selections to add** list.
- 9 Click **OK**.
- 10 In the **Settings** window for **Union**, locate the **Input Entities** section.
- 11 Under **Selections to add**, click  **Add**.
- 12 In the **Add** dialog, select **ICs, Type 3** in the **Selections to add** list.

13 Click **OK**.

ADD MATERIAL

- 1 In the **Materials** toolbar, click  **Add Material** to open the **Add Material** window.
- 2 Go to the **Add Material** window.
- 3 In the tree, select **Built-in > Silica glass**.
- 4 Click the **Add to Component** button in the window toolbar.
- 5 In the tree, select **Built-in > FR4 (Circuit Board)**.
- 6 Click the **Add to Component** button in the window toolbar.
- 7 In the **Materials** toolbar, click  **Add Material** to close the **Add Material** window.

MATERIALS

Silica glass (mat1)

- 1 In the **Settings** window for **Material**, locate the **Geometric Entity Selection** section.
- 2 From the **Selection** list, choose **ICs**.

FR4 (Circuit Board) (mat2)

- 1 In the **Model Builder** window, click **FR4 (Circuit Board) (mat2)**.
- 2 Select Domain 1 only.

Here, the PC board needs to have an orthotropic thermal conductivity to account for conduction induced by several copper tracks in the xy -planes of the board.

- 3 In the **Settings** window for **Material**, locate the **Material Contents** section.
- 4 In the table, enter the following settings:

Property	Variable	Value	Unit	Property group
Thermal conductivity	{k11, k22, k33} ; kij = 0	{80[W/(m*K)] , 80[W/(m*K)] , 0.3[W/(m*K)] }	W/(m·K)	Basic

HEAT TRANSFER IN SOLIDS (HT)

Initial Values 1

- 1 In the **Model Builder** window, under **Component 1 (comp1) > Heat Transfer in Solids (ht)** click **Initial Values 1**.
- 2 In the **Settings** window for **Initial Values**, locate the **Initial Values** section.

3 In the T text field, type T0.

Heat Source 1

- 1 In the **Physics** toolbar, click  **Domains** and choose **Heat Source**.
- 2 In the **Settings** window for **Heat Source**, locate the **Domain Selection** section.
- 3 From the **Selection** list, choose **ICs, Type 1**.
- 4 Locate the **Heat Source** section. From the **Heat source** list, choose **Heat rate**.
- 5 In the P_0 text field, type P1.

Heat Source 2

- 1 In the **Physics** toolbar, click  **Domains** and choose **Heat Source**.
- 2 In the **Settings** window for **Heat Source**, locate the **Domain Selection** section.
- 3 From the **Selection** list, choose **ICs, Type 2**.
- 4 Locate the **Heat Source** section. From the **Heat source** list, choose **Heat rate**.
- 5 In the P_0 text field, type P2*8.

Heat Source 3

- 1 In the **Physics** toolbar, click  **Domains** and choose **Heat Source**.
- 2 In the **Settings** window for **Heat Source**, locate the **Domain Selection** section.
- 3 From the **Selection** list, choose **ICs, Type 3**.
- 4 Locate the **Heat Source** section. From the **Heat source** list, choose **Heat rate**.
- 5 In the P_0 text field, type P3*2.

Heat Flux 1

- 1 In the **Physics** toolbar, click  **Boundaries** and choose **Heat Flux**.
- 2 In the **Settings** window for **Heat Flux**, locate the **Heat Flux** section.
- 3 From the **Flux type** list, choose **Convective heat flux**.
- 4 In the h text field, type htc.
- 5 In the T_{ext} text field, type T0.

In the followings, select boundaries 1 to 72. For more convenience, use the **Paste Selection** button.

- 6 Locate the **Boundary Selection** section. Click  **Paste Selection**.
- 7 In the **Paste Selection** dialog, type 1-72 in the **Selection** text field.
- 8 Click **OK**.

STUDY I

In the **Study** toolbar, click  **Compute**.

RESULTS



Temperature Without Heat Sink

1 In the **Settings** window for **3D Plot Group**, type Temperature Without Heat Sink in the **Label** text field.

This is the first temperature distribution. It clearly outlines that the main chip needs more efficient cooling. This is the aim of the next part in which a disk-stack heat sink will be added on the top of the central chip.

GEOMETRY I

Block 5 (blk5)



- 1 In the **Geometry** toolbar, click  **Block**.
- 2 In the **Settings** window for **Block**, locate the **Size and Shape** section.
- 3 In the **Width** text field, type IC1_w.
- 4 In the **Depth** text field, type IC1_l.
- 5 In the **Height** text field, type IC1_t.
- 6 Locate the **Position** section. In the **x** text field, type $-CB_w/2+IC1_w$.
- 7 In the **y** text field, type $-CB_l/2+IC1_l$.
- 8 In the **z** text field, type IC1_t.
- 9 Click  **Build Selected**.

Cylinder 1 (cyl1)



- 1 In the **Geometry** toolbar, click  **Cylinder**.
- 2 In the **Settings** window for **Cylinder**, locate the **Object Type** section.
- 3 From the **Type** list, choose **Surface**.
- 4 Locate the **Size and Shape** section. In the **Radius** text field, type i_radius.
- 5 In the **Height** text field, type t_h.
- 6 Locate the **Position** section. In the **z** text field, type $IC1_t*2$.
- 7 Locate the **Selections of Resulting Entities** section. Find the **Cumulative selection** subsection. Click **New**.
- 8 In the **New Cumulative Selection** dialog, type Fins in the **Name** text field.
- 9 Click **OK**.

10 In the **Settings** window for **Cylinder**, click  **Build Selected**.



Work Plane 1 (wp1)

- 1 In the **Geometry** toolbar, click  **Work Plane**.
- 2 In the **Settings** window for **Work Plane**, locate the **Plane Definition** section.
- 3 From the **Plane type** list, choose **Face parallel**.
- 4 On the object **blk5**, select Boundary 4 only.
- 5 In the **Offset in normal direction** text field, type `air_sp`.
- 6 Click  **Go to Plane Geometry**.



Work Plane 1 (wp1) > Circle 1 (c1)

- 1 In the **Work Plane** toolbar, click  **Circle**.
- 2 In the **Settings** window for **Circle**, locate the **Size and Shape** section.
- 3 In the **Radius** text field, type `i_radius`.
- 4 Click  **Build Selected**.
- 5 Click the  **Zoom Extents** button in the **Graphics** toolbar.

Work Plane 1 (wp1) > Circle 2 (c2)

- 1 In the **Work Plane** toolbar, click  **Circle**.
- 2 In the **Settings** window for **Circle**, locate the **Size and Shape** section.
- 3 In the **Radius** text field, type `o_radius`.
- 4 Click  **Build Selected**.
- 5 Click the  **Zoom Extents** button in the **Graphics** toolbar.

Work Plane 1 (wp1) > Difference 1 (dif1)



- 1 In the **Work Plane** toolbar, click  **Booleans and Partitions** and choose **Difference**.
- 2 Select the object **c2** only.
- 3 In the **Settings** window for **Difference**, locate the **Difference** section.
- 4 Click to select the  **Activate Selection** toggle button for **Objects to subtract**.
- 5 Select the object **c1** only.
- 6 Click  **Build Selected**.

Work Plane 1 (wp1)



- 1 In the **Model Builder** window, under **Component 1 (comp1) > Geometry 1** click **Work Plane 1 (wp1)**.
- 2 In the **Settings** window for **Work Plane**, locate the **Selections of Resulting Entities** section.

- 3 Find the **Cumulative selection** subsection. From the **Contribute to** list, choose **Fins**.
- 4 Click  **Build Selected**.

Array 1 (arr1)

- 1 In the **Geometry** toolbar, click  **Transforms** and choose **Array**.
- 2 Select the object **wp1** only.
- 3 In the **Settings** window for **Array**, locate the **Size** section.
- 4 From the **Array type** list, choose **Linear**.
- 5 In the **Size** text field, type `n_fins`.
- 6 Locate the **Displacement** section. In the **z** text field, type `air_sp`.
- 7 Locate the **Selections of Resulting Entities** section. Find the **Cumulative selection** subsection. From the **Contribute to** list, choose **Fins**.
- 8 In the **Geometry** toolbar, click  **Build All**.

ADD MATERIAL

- 1 In the **Materials** toolbar, click  **Add Material** to open the **Add Material** window.
- 2 Go to the **Add Material** window.
- 3 In the tree, select **Built-in > Aluminum**.
- 4 Click the **Add to Component** button in the window toolbar.
- 5 In the tree, select **Built-in > Aluminum**.
- 6 Click the **Add to Component** button in the window toolbar.
- 7 In the **Materials** toolbar, click  **Add Material** to close the **Add Material** window.

MATERIALS

Aluminum (mat3)

Select Domain 10 only.

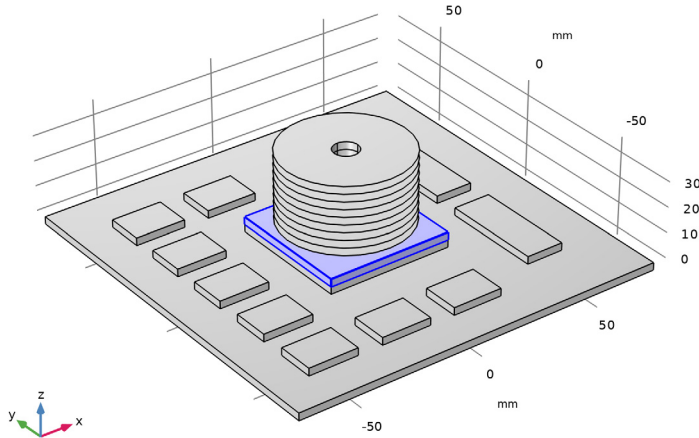

Aluminum Fins

- 1 In the **Model Builder** window, under **Component 1 (comp1)** > **Materials** click **Aluminum 1 (mat4)**.
- 2 In the **Settings** window for **Material**, type Aluminum Fins in the **Label** text field.
- 3 Locate the **Geometric Entity Selection** section. From the **Geometric entity level** list, choose **Boundary**.
- 4 From the **Selection** list, choose **Fins**.

It is necessary to add a second **Aluminum** material since the first one is used on a different geometric-entity level.

HEAT TRANSFER IN SOLIDS (HT)



Heat Flux 1

Add the newly created external boundaries of the heat sink base.



- 1 In the **Model Builder** window, under **Component 1 (comp1)** > **Heat Transfer in Solids (ht)** click **Heat Flux 1**.
- 2 In the **Settings** window for **Heat Flux**, locate the **Boundary Selection** section.

- 3 Click  **Paste Selection**.
- 4 In the **Paste Selection** dialog, type 49 50 52 64 115 in the **Selection** text field.
- 5 Click **OK**.

Thermal Contact I

- 1 In the **Physics** toolbar, click  **Boundaries** and choose **Thermal Contact**.
- 2 In the **Settings** window for **Thermal Contact**, locate the **Boundary Selection** section.
- 3 Click  **Paste Selection**.
- 4 In the **Paste Selection** dialog, type 51 in the **Selection** text field.
- 5 Click **OK**.
- 6 In the **Settings** window for **Thermal Contact**, locate the **Thermal Contact** section.
- 7 From the h_g list, choose **Parallel-plate gap gas conductance**.
- 8 Locate the **Contact Surface Properties** section. In the p text field, type 20[kPa].
- 9 In the H_c text field, type 165[MPa].
- 10 Click to expand the **Gap Properties** section. From the k_{gap} list, choose **User defined**.

ADD PHYSICS

- 1 In the **Home** toolbar, click  **Add Physics** to open the **Add Physics** window.
- 2 Go to the **Add Physics** window.
- 3 In the tree, select **Heat Transfer > Thin Structures > Heat Transfer in Shells (htlsh)**.
- 4 Click to expand the **Dependent Variables** section. A new physics interface is required here to take into account out-of-plane convective cooling. In the physics interface selection, you have to use the same temperature variable, T, to couple the two physics interfaces.
- 5 Click the **Add to Component I** button in the window toolbar.
- 6 In the **Home** toolbar, click  **Add Physics** to close the **Add Physics** window.

HEAT TRANSFER IN SHELLS (HTLSH)

- 1 In the **Settings** window for **Heat Transfer in Shells**, locate the **Boundary Selection** section.
- 2 From the **Selection** list, choose **Fins**.

Heat Flux, Interface I

- 1 In the **Physics** toolbar, click  **Boundaries** and choose **Heat Flux, Interface**.
- 2 In the **Settings** window for **Heat Flux, Interface**, locate the **Boundary Selection** section.
- 3 From the **Selection** list, choose **Fins**.
- 4 Locate the **Heat Flux** section. From the **Flux type** list, choose **Convective heat flux**.

- 5 In the h text field, type htc.
- 6 In the T_{ext} text field, type T0.

MATERIALS

Aluminum Fins (mat4)

- 1 In the **Model Builder** window, under **Component 1 (comp1) > Materials** click **Aluminum Fins (mat4)**.
- 2 In the **Settings** window for **Material**, locate the **Material Contents** section.
- 3 In the table, enter the following settings:



Property	Variable	Value	Unit	Property group
Thickness	lth	e_fins	m	Shell

MULTIPHYSICS

Thermal Connection, Layered Shell, Edges 1 (tcls1)

- In the **Physics** toolbar, click  **Multiphysics Couplings** and choose **Edge > Thermal Connection, Layered Shell, Edges**.

ADD STUDY

- 1 In the **Home** toolbar, click  **Add Study** to open the **Add Study** window.
- 2 Go to the **Add Study** window.
- 3 Find the **Studies** subsection. In the **Select Study** tree, select **General Studies > Stationary**.
- 4 Right-click and choose **Add Study**.
- 5 In the **Home** toolbar, click  **Add Study** to close the **Add Study** window.

STUDY 2

- In the **Study** toolbar, click  **Compute**.

RESULTS

Temperature (ht), Temperature, Shell (htlsh)

- 1 In the **Model Builder** window, under **Results**, Ctrl-click to select **Temperature (ht)** and **Temperature, Shell (htlsh)**.
- 2 Right-click and choose **Delete**.

RESULT TEMPLATES

- 1 In the **Results** toolbar, click  **Result Templates** to open the **Result Templates** window.



- 2 Go to the **Result Templates** window.
- 3 In the tree, select **Study 2/Solution 2 (sol2) > Thermal Connection, Layered Shell, Edges 1 > Temperature (tcls1)**.
- 4 Click the **Add Result Template** button in the window toolbar.
- 5 In the **Results** toolbar, click  **Result Templates** to close the **Result Templates** window.

RESULTS

Temperature With Heat Sink

- 1 In the **Settings** window for **3D Plot Group**, type **Temperature With Heat Sink** in the **Label** text field.
- 2 In the **Temperature With Heat Sink** toolbar, click  **Plot**.
This is the temperature profile once the heat sink has been added. The heat sink significantly reduces the average temperature of the main chip.

ADD MATERIAL

- 1 In the **Materials** toolbar, click  **Add Material** to open the **Add Material** window.
- 2 Go to the **Add Material** window.
- 3 In the tree, select **Built-in > Copper**.
- 4 Click the **Add to Component** button in the window toolbar.
- 5 In the **Materials** toolbar, click  **Add Material** to close the **Add Material** window.

HEAT TRANSFER IN SOLIDS (HT)

Thin Layer 1

- 1 In the **Physics** toolbar, click  **Boundaries** and choose **Thin Layer**.
- 2 In the **Settings** window for **Thin Layer**, locate the **Layer Model** section.
- 3 From the **Layer type** list, choose **Thermally thin approximation**.
- 4 Select Boundary 3 only.

MATERIALS

Copper (mat5)

- 1 In the **Model Builder** window, under **Component 1 (comp1) > Materials** click **Copper (mat5)**.
- 2 In the **Settings** window for **Material**, locate the **Geometric Entity Selection** section.
- 3 From the **Geometric entity level** list, choose **Boundary**.

4 Select Boundary 3 only.

5 Locate the **Material Contents** section. In the table, enter the following settings:

Property	Variable	Value	Unit	Property group
Thickness	lth	e_fins	m	Shell

STUDY 2

In the **Study** toolbar, click  **Compute**.



RESULTS

Temperature With Heat Sink

This is the temperature profile once the copper layer has been added. No significant effect due to this modification can be observed.

In order to visualize the temperature on each side of the thermal contact, follow the next steps.

RESULT TEMPLATES

- 1 In the **Results** toolbar, click  **Result Templates** to open the **Result Templates** window.
- 2 Go to the **Result Templates** window.
- 3 In the tree, select **Study 2/Solution 2 (sol2) > Heat Transfer in Solids > Contact Temperature (ht)**.
- 4 Click the **Add Result Template** button in the window toolbar.
- 5 In the **Results** toolbar, click  **Result Templates** to close the **Result Templates** window.

RESULTS

Contact Temperature With Heat Sink

In the **Settings** window for **3D Plot Group**, type Contact Temperature With Heat Sink in the **Label** text field.

Finally, check the maximum temperature over the component.

Maximum Temperature

- 1 In the **Results** toolbar, click  **More Derived Values** and choose **Maximum > Volume Maximum**.
- 2 In the **Settings** window for **Volume Maximum**, type Maximum Temperature in the **Label** text field.
- 3 Locate the **Data** section. From the **Dataset** list, choose **Study 2/Solution 2 (sol2)**.

- 4 Locate the **Selection** section. From the **Selection** list, choose **All domains**.
- 5 Locate the **Expressions** section. In the table, enter the following settings:

Expression	Unit	Description
T	K	Maximum temperature

- 6 Click  **Evaluate**.