



Model created in COMSOL Multiphysics 6.4

# Electronic Chip Cooling

## *Introduction*

---

This model is an introduction to simulations of device cooling. A device (here a chip associated to a heat sink) is cooled by a surrounding fluid, air in this case. This tutorial demonstrates the following important steps:

- Defining a heat rate on a domain using automatic volume computation.
- Modeling the temperature difference between two surfaces when a thermally thick layer is present.
- Including the radiative heat transfer between surfaces in a model.

In addition, this tutorial compares two approaches for modeling the air cooling. First, only the solid is represented and a convective cooling heat flux boundary condition is used to account for the heat transfer between the solid and the fluid. In a second step, the air domain is included in the model and a nonisothermal flow model is defined.

## *Model Definition*

---

The modeled system describes an aluminum heat sink used for the cooling of an electronic chip, as shown in [Figure 1](#).

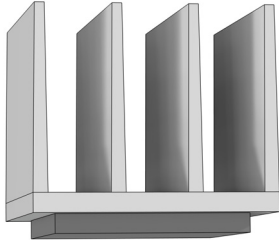

*Figure 1: Geometry of the heat sink and the electronic chip.*

The heat sink represented in gray in [Figure 1](#) is mounted inside a channel with a rectangular cross section. Such a setup is used to measure the cooling capacity of heat sinks. Air enters the channel at the inlet and exits the channel at the outlet. Thermal grease is used to improve the thermal contact between the base of the heat sink and the top surface of the electronic component. All other external faces are thermally insulated. The heat dissipated by the electronic component is equal to 5 W and is distributed through the chip volume.

The cooling capacity of the heat sink can be determined by monitoring the temperature in the electronic component.

The model solves a thermal balance for the electronic component, heat sink, and air flowing in the rectangular channel. Thermal energy is transferred by conduction in the electronic component and the aluminum heat sink. Thermal energy is transported by conduction and advection in the cooling air. Unless an efficient thermal grease is used to improve the thermal contact between the electronic component and the heat sink, the temperature field varies sharply there. The temperature is set at the inlet of the channel. The transport of thermal energy at the outlet is dominated by convection.

Initially, heat transfer by radiation between surfaces is neglected. This assumption is valid as the surfaces have low emissivity (close to 0), which is usually the case for polished metals. In a case where the surface emissivity is large (close to 1), the surface-to-surface radiation should be considered. This is done later in this tutorial, where the model is modified to account for surface-to-surface radiation at the channel walls and heat sink boundaries. Assuming that the surfaces have been treated with black paint, the surface emissivity is close to 1 in this second case.

The flow field is obtained by solving one momentum balance relation for each space coordinate ( $x$ ,  $y$ , and  $z$ ) and a mass balance equation. The inlet velocity is defined by a parabolic velocity profile for fully developed laminar flow. At the outlet, the normal stress is equal to the outlet pressure and the tangential stress is canceled. At all solid surfaces, the velocity is set to zero in all three spatial directions.

The thermal conductivity of air, heat capacity of air, and air density are all temperature-dependent material properties. You can find all of the settings in the physics interface for Conjugate Heat Transfer in COMSOL Multiphysics. The material properties, including their temperature dependence, are available in the Material Browser.

## *Results and Discussion*

---

### **MODELING USING CONVECTIVE COOLING BOUNDARY CONDITION**

In this part of the model, only the solid domains are represented. Instead of computing the flow velocity, pressure, and temperature in the air channel, a convective cooling boundary condition is used at the heat sink boundaries. The approach enables very quick computations, but its accuracy relies on the heat transfer coefficient that is used to define the convective cooling condition. In this configuration, an empirical value,  $10 \text{ W}/(\text{m}^2 \cdot \text{K})$ , is used.

Next, to model the thermal contact between the heat sink and the chip three hypotheses are considered. In a first simulation an ideal contact is assumed.

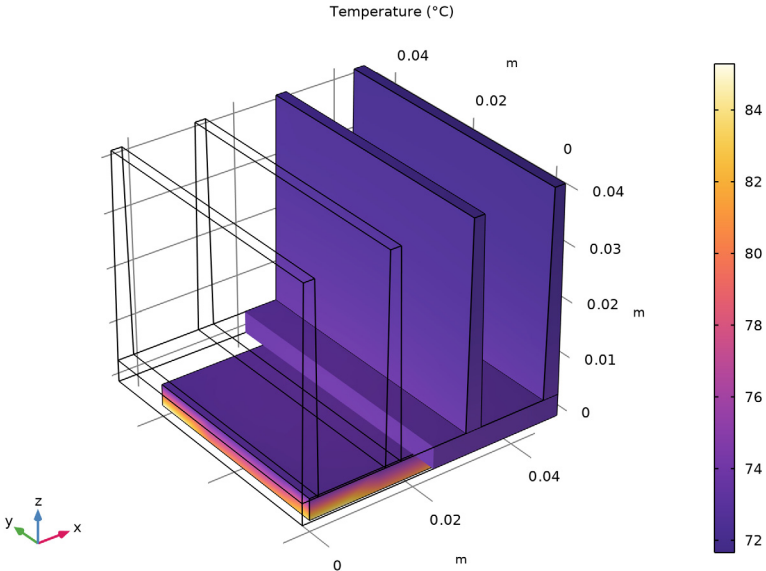
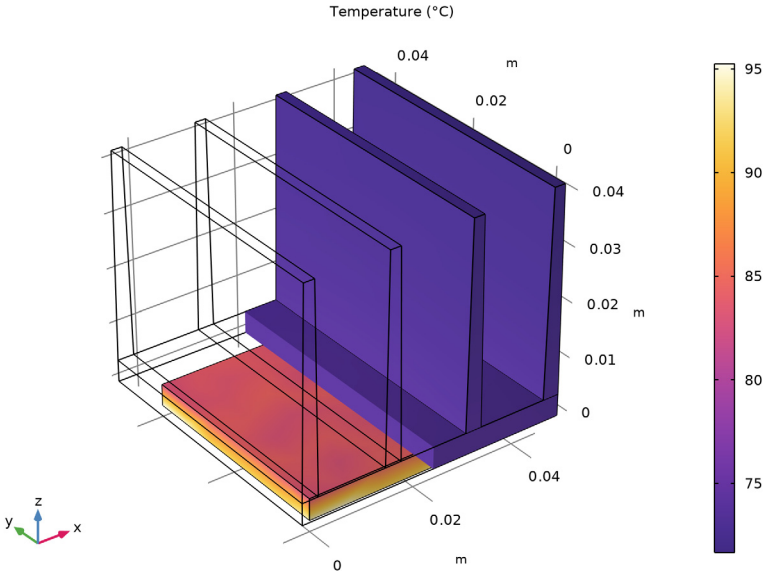

Figure 2: Temperature plot of the heat sink for the first configuration.

Under ideal conditions, the maximum temperature in the chip is about 85°C.

In the second simulation, a 50- $\mu\text{m}$ -thick layer of air between the heat sink and the chip is assumed to create a thermal resistance.



*Figure 3: Temperature plot of the heat sink for the second configuration.*

The thermal resistance decreases the performance of the heat sink and the maximum temperature is close to 95°C.

Finally, a third configuration is tested where the thin layer contains thermal grease instead of air.

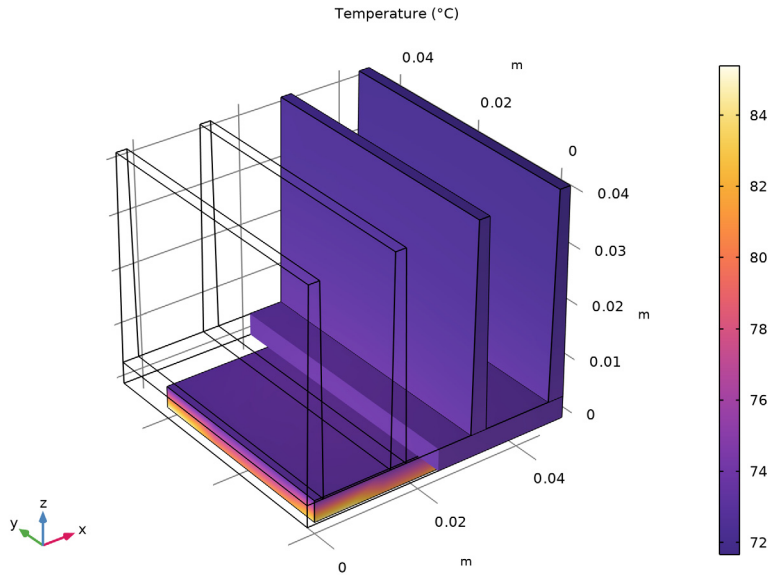

*Figure 4: Temperature plot.*

The maximum temperature is close to the one observed in the first configuration with an ideal thermal contact. This means that the effect of the thermal resistance is greatly reduced by the thermal grease, which has a higher thermal conductivity than air.

#### **MODELING USING NONISOTHERMAL FLOW IN THE CHANNEL**

Since the heat transfer coefficient is in general unknown, an alternative approach is suitable. In this part, a domain corresponding to the air channel is added to the geometry in order to compute the flow and the temperature field in the air. This leads to more computationally expensive simulations, but the approach is more general.

In [Figure 5](#), the hot wake behind the heat sink is a sign of the convective cooling effects. The maximum temperature, reached in the electronic component, is about 85°C.

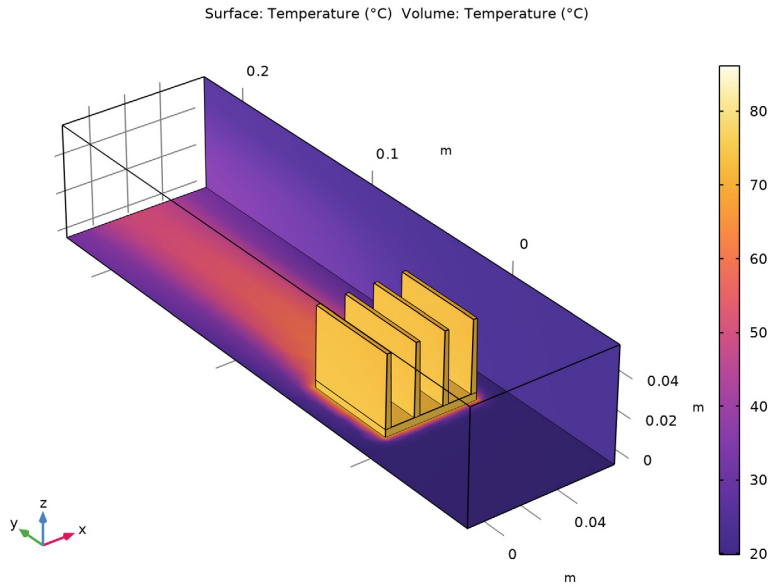
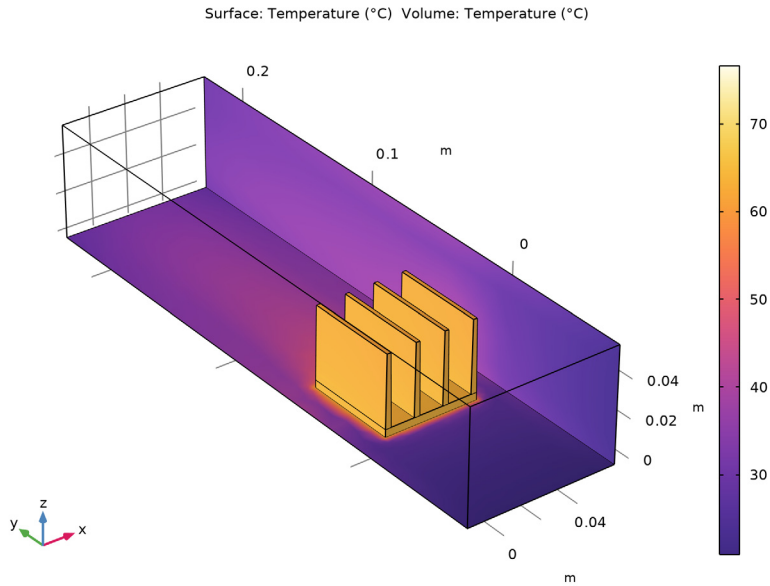

*Figure 5: The surface plot shows the temperature field on the channel walls and the heat sink surface.*

Compared with the first approach (without the air domain), the results are different. This shows that using a heat transfer coefficient that is not well known, as in the first approach, leads to inaccurate results.

In the second step, the temperature and velocity fields are obtained when surface-to-surface radiation is included and the surface emissivities are large. [Figure 6](#) shows that the maximum temperature, about 75°C, is decreased by about 10°C when compared to the

first case in [Figure 5](#). This confirms that radiative heat transfer is not negligible when the surface emissivity is close to 1.



*Figure 6: The effects of surface-to-surface radiation on temperature. The surface plot shows the temperature field on the channel walls and the heat sink surface.*

---

**Application Library path:** Heat\_Transfer\_Module/Tutorials,  
\_Forced\_and\_Natural\_Convection/chip\_cooling

---

From the **File** menu, choose **New**.

#### **NEW**

In the **New** window, click  **Model Wizard**.

#### **MODEL WIZARD**

**1** In the **Model Wizard** window, click  **3D**.

**2** In the **Select Physics** tree, select **Heat Transfer > Heat Transfer in Solids and Fluids (ht)**.

**3** Click **Add**.

**4** Click  **Study**.

5 In the **Select Study** tree, select **General Studies > Stationary**.

6 Click  **Done**.

## GLOBAL DEFINITIONS

### *Parameters I*

1 In the **Model Builder** window, under **Global Definitions** click **Parameters I**.

2 In the **Settings** window for **Parameters**, locate the **Parameters** section.

3 Click  **Load from File**.

4 Browse to the model's Application Libraries folder and double-click the file `chip_cooling.txt`.

## GEOMETRY I

### *Block I (blk1)*

1 In the **Geometry** toolbar, click  **Block**.

2 In the **Settings** window for **Block**, locate the **Size and Shape** section.

3 In the **Width** text field, type `L_chip`.

4 In the **Depth** text field, type `L_chip`.

5 In the **Height** text field, type `H_chip`.

6 Locate the **Position** section. In the **z** text field, type `-H_chip`.

7 Click  **Build Selected**.

## PART LIBRARIES

1 In the **Geometry** toolbar, click  **Part Libraries**.

2 In the **Model Builder** window, click **Geometry I**.

3 In the **Part Libraries** window, select **Heat Transfer Module > Heat Sinks > heat\_sink\_straight\_fins** in the tree.

4 Click  **Add to Geometry**.

## GEOMETRY I

### *Heat Sink - Straight Fins I (pi1)*

1 In the **Model Builder** window, under **Component I (comp1) > Geometry I** click **Heat Sink - Straight Fins I (pi1)**.

2 In the **Settings** window for **Part Instance**, locate the **Input Parameters** section.

3 In the table, enter the following settings:

Name	Expression	Value	Description
n_fins_x	n_fins	4	Amount of fins in x direction
X_fins_bottom	3[mm]	0.003 m	Fin dimension in x direction, bottom
X_fins_top	2[mm]	0.002 m	Fin dimension in x direction, top

4 Locate the **Position and Orientation of Output** section. Find the **Coordinate system in part** subsection. From the **Work plane in part** list, choose **Work plane for heat sink base (wp11)**.

5 Find the **Displacement** subsection. In the **xwi** text field, type -5[mm].

6 In the **ywi** text field, type -5[mm].

7 Click to expand the **Domain Selections** section. In the table, enter the following settings:

Name	Keep	Physics	Contribute to
Heat sink base		√	None
Step domain		√	None
Array of fins		√	None
All	√	√	None

8 Click to collapse the **Domain Selections** section. Click to expand the **Boundary Selections** section. In the table, enter the following settings:

Name	Keep	Physics	Contribute to
Bottom boundary		√	None
Exterior		√	None
Exterior boundaries without heat sink base	√	√	None
All		√	None

9 Click to collapse the **Boundary Selections** section. In the **Geometry** toolbar, click



 **Build All**.

10 Click the  **Zoom Extents** button in the **Graphics** toolbar.

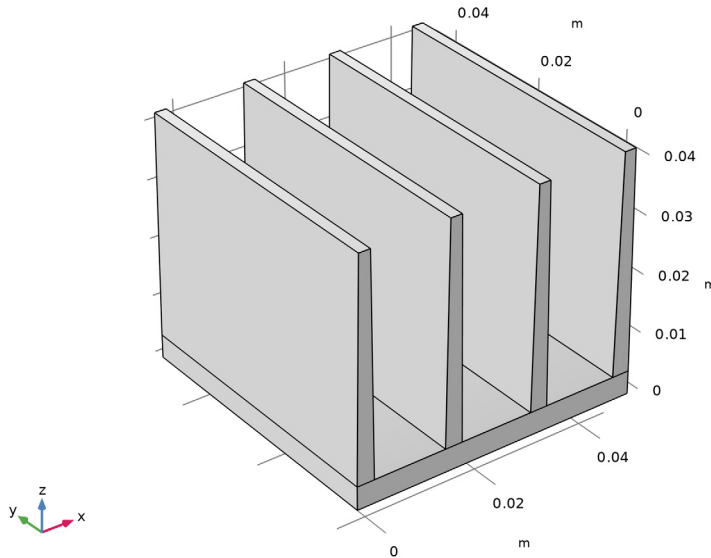
II In the **Model Builder** window, click **Geometry 1**.





### ADD MATERIAL

- 1 In the **Home** toolbar, click  **Add Material** to open the **Add Material** window.
- 2 Go to the **Add Material** window.
- 3 In the tree, select **Built-in** > **Aluminum**.
- 4 Right-click and choose **Add to Component 1 (comp1)**.
- 5 In the tree, select **Built-in** > **Silica glass**.
- 6 Right-click and choose **Add to Component 1 (comp1)**.
- 7 In the **Home** toolbar, click  **Add Material** to close the **Add Material** window.

### MATERIALS

*Silica glass (mat2)*

- 1 Click the  **Zoom Extents** button in the **Graphics** toolbar.
- 2 Click the  **Wireframe Rendering** button in the **Graphics** toolbar.
- 3 Select Domain 3 only.

In order to easily reuse the selection of the domain corresponding to the chip, create a dedicated selection for it.

- 4 In the **Settings** window for **Material**, locate the **Geometric Entity Selection** section.
- 5 Click  **Create Selection**.
- 6 In the **Create Selection** dialog, type Chip in the **Selection name** text field.
- 7 Click **OK**.

## DEFINITIONS

### *Ambient Properties I (ampri)*



In the **Physics** toolbar, click  **Shared Properties** and choose **Ambient Properties**.

## HEAT TRANSFER IN SOLIDS AND FLUIDS (HT)

### *Heat Source I*

- 1 In the **Physics** toolbar, click  **Domains** and choose **Heat Source**.
- 2 In the **Settings** window for **Heat Source**, locate the **Domain Selection** section.
- 3 From the **Selection** list, choose **Chip**.
- 4 Locate the **Heat Source** section. From the **Heat source** list, choose **Heat rate**.
- 5 In the  $P_0$  text field, type P0.



### *Heat Flux I*

- 1 In the **Physics** toolbar, click  **Boundaries** and choose **Heat Flux**.
- 2 In the **Settings** window for **Heat Flux**, locate the **Boundary Selection** section.
- 3 From the **Selection** list, choose **Exterior boundaries without heat sink base (Heat Sink - Straight Fins I)**.
- 4 Locate the **Heat Flux** section. From the **Flux type** list, choose **Convective heat flux**.  
First enter the heat transfer coefficient defined from a parameter.
- 5 In the  $h$  text field, type h0.  
Then the external temperature is set to the ambient temperature defined in the **Ambient Properties I** node (the default value is 293.15 K).
- 6 From the  $T_{\text{ext}}$  list, choose **Ambient temperature (ampri)**.
- 7 In the **Home** toolbar, click  **Compute**.  
The computation takes a few seconds and about 1 GB of memory.

## RESULTS

Change the unit of the temperature results to degrees Celsius.

### Preferred Units 1

- 1 In the **Results** toolbar, click  **Configurations** and choose **Preferred Units**.
- 2 In the **Settings** window for **Preferred Units**, locate the **Units** section.
- 3 Click  **Add Physical Quantity**.
- 4 In the **Physical Quantity** dialog, select **General > Temperature (K)** in the tree.
- 5 Click **OK**.
- 6 In the **Settings** window for **Preferred Units**, locate the **Units** section.
- 7 In the table, enter the following settings:

Quantity	Unit	Preferred unit
Temperature	K	°C

- 8 Click  **Apply**.

### Temperature (ht)

The automatically generated default plot shows the temperature in the domain. Modify this plot to display the temperature at the interface between the chip and the heat sink by applying the existing domain selections to the volume plot.

### Selection 1

- 1 In the **Model Builder** window, expand the **Temperature (ht)** node.
- 2 Right-click **Volume 1** and choose **Selection**.
- 3 In the **Settings** window for **Selection**, locate the **Selection** section.
- 4 From the **Selection** list, choose **Chip**.

### Volume 2

Right-click **Volume 1** and choose **Duplicate**.

### Selection 1

- 1 In the **Model Builder** window, expand the **Volume 2** node, then click **Selection 1**.
- 2 In the **Settings** window for **Selection**, locate the **Selection** section.
- 3 From the **Selection** list, choose **All (Heat Sink - Straight Fins 1)**.

### Volume 2

- 1 In the **Model Builder** window, click **Volume 2**.
- 2 In the **Settings** window for **Volume**, click to expand the **Title** section.
- 3 From the **Title type** list, choose **None**.
- 4 Click to expand the **Inherit Style** section. From the **Plot** list, choose **Volume 1**.

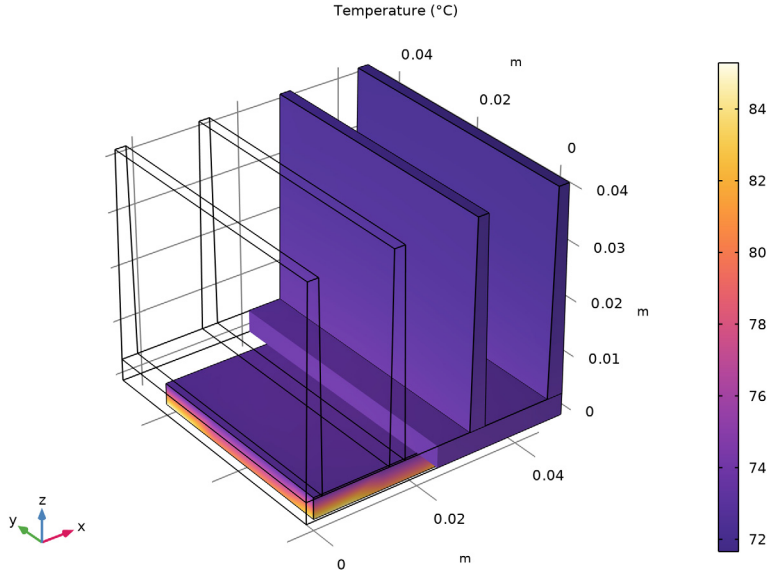

### Filter 1

- 1 Right-click **Volume 2** and choose **Filter**.
- 2 In the **Settings** window for **Filter**, locate the **Element Selection** section.
- 3 In the **Logical expression for inclusion** text field, type  $x > 0.02$ .
- 4 In the **Temperature (ht)** toolbar, click  **Plot**.



Compare with the temperature plot shown above.

### GEOMETRY 1

- 1 Click the  **Go to Default View** button in the **Graphics** toolbar.
- 2 Click the  **Zoom Extents** button in the **Graphics** toolbar.

Now update the model to evaluate the effect of the thermal contact between the chip and the heat sink. First assume a poor thermal contact due to a thin film of air between the chip and the heat sink.

### HEAT TRANSFER IN SOLIDS AND FLUIDS (HT)

#### Thermal Contact 1

- 1 In the **Physics** toolbar, click  **Boundaries** and choose **Thermal Contact**.

2 Select Boundary 15 only.

To facilitate the selection of this boundary in the following steps, create a dedicated selection for it.

3 In the **Settings** window for **Thermal Contact**, locate the **Boundary Selection** section.

4 Click  **Create Selection**.

5 In the **Create Selection** dialog, type Chip/Heat Sink Interface in the **Selection name** text field.

6 Click **OK**.

7 In the **Settings** window for **Thermal Contact**, locate the **Thermal Contact** section.

8 From the **Contact model** list, choose **Equivalent thin resistive layer**.

9 From the **Specify** list, choose **Layer thermal conductivity and thickness**.

10 In the  $d_s$  text field, type 50[um].

## MATERIALS

Define the material (air) present at the interface between the chip and the heat sink.

### ADD MATERIAL

1 In the **Materials** toolbar, click  **Add Material** to open the **Add Material** window.

2 Go to the **Add Material** window.

3 In the tree, select **Built-in > Air**.

4 Right-click and choose **Add to Component 1 (comp1)**.

5 In the **Materials** toolbar, click  **Add Material** to close the **Add Material** window.

## MATERIALS

*Air (mat3)*

1 In the **Settings** window for **Material**, locate the **Geometric Entity Selection** section.

2 From the **Geometric entity level** list, choose **Boundary**.

3 From the **Selection** list, choose **Chip/Heat Sink Interface**.

4 In the **Home** toolbar, click  **Compute**.

## RESULTS

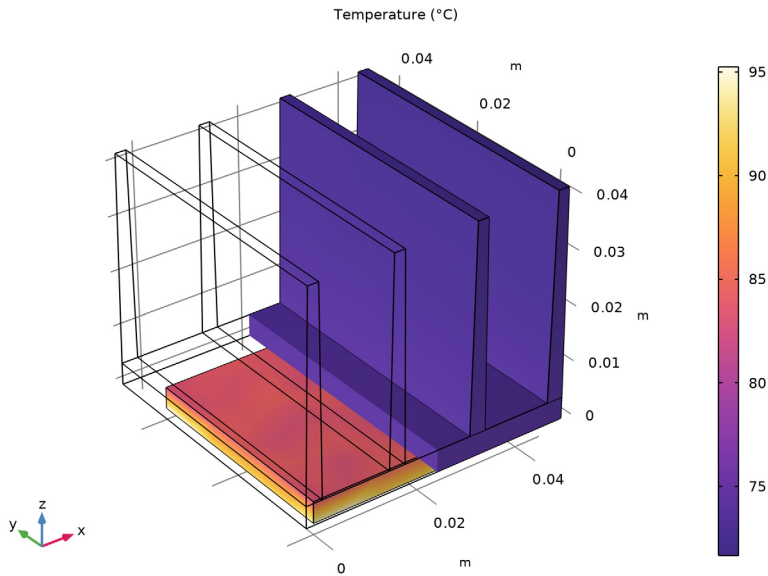

### Temperature (ht)



The temperature plot is updated after the computation. Note that the presence of the thin layer of air between the chip and the heat sink induced approximately 10°C increase of the maximum temperature.

Now assume that thermal grease is used to avoid an air layer at the interface between the chip and the heat sink. Update the model in order to check how the cooling is improved by this change.

### ADD MATERIAL

- 1 In the **Home** toolbar, click  **Add Material** to open the **Add Material** window.
- 2 Go to the **Add Material** window.
- 3 In the tree, select **Built-in** > **Thermal grease**.
- 4 Right-click and choose **Add to Component 1 (comp1)**.
- 5 In the **Home** toolbar, click  **Add Material** to close the **Add Material** window.

## MATERIALS

*Thermal grease (mat4)*

- 1 In the **Settings** window for **Material**, locate the **Geometric Entity Selection** section.
- 2 From the **Geometric entity level** list, choose **Boundary**.
- 3 From the **Selection** list, choose **Chip/Heat Sink Interface**.

The red triangle in the **Air** material icon indicates that it is overridden by the **Thermal grease** material.

- 4 In the **Home** toolbar, click  **Compute**.

## RESULTS

*Temperature (ht)*

The temperature plot is updated and shows the temperature distribution when thermal grease is used.

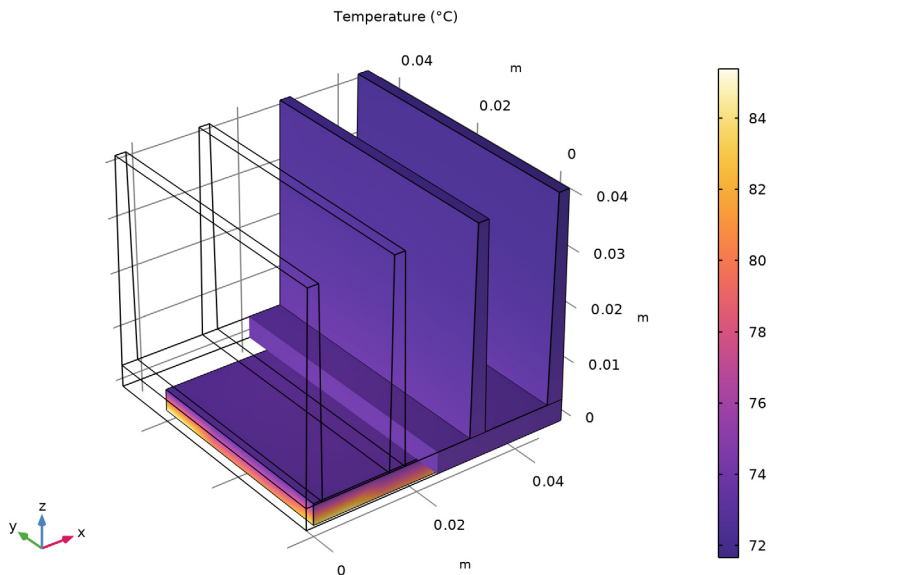

At this point we can evaluate the effect of the quality of the thermal contact. In the first computation, the thermal contact was assumed to be ideal and the maximum temperature was around 86°C. When accounting for a 50- $\mu\text{m}$ -wide air layer the maximum temperature was close to 96°C. Using thermal grease to enhance the thermal contact seems efficient



here as the maximum temperature is only slightly higher than the initial case of ideal thermal contact.

In the first part, we have been using a convective cooling boundary condition to account for the airflow cooling. While there are a number of geometrical configurations for which the heat transfer coefficient is known with very good accuracy, that is not the case for this particular heat sink geometry.

Modify the model to include the air channel in the geometry and to compute the air velocity. Then, you can accurately model the flow cooling without relying on any approximation of the heat transfer coefficient.

## GEOMETRY I

*Block 2 (blk2)*

- 1 In the **Geometry** toolbar, click  **Block**.
- 2 In the **Settings** window for **Block**, locate the **Size and Shape** section.
- 3 In the **Width** text field, type `W_channel`.
- 4 In the **Depth** text field, type `D_channel`.
- 5 In the **Height** text field, type `H_channel`.
- 6 Locate the **Position** section. In the **x** text field, type `-(W_channel-40[mm])/2`.
- 7 In the **y** text field, type `-80[mm]`.
- 8 In the **Geometry** toolbar, click  **Build All**.
- 9 Click the  **Zoom Extents** button in the **Graphics** toolbar.

Define the material properties in the newly created channel domain.

## MATERIALS

*Air 1 (mat5)*



- 1 In the **Model Builder** window, under **Component 1 (comp1) > Materials** right-click **Air (mat3)** and choose **Duplicate**.

This creates a new instance of the Air material that will be applied to the domain selection corresponding to the channel.

- 2 In the **Settings** window for **Material**, locate the **Geometric Entity Selection** section.
- 3 From the **Geometric entity level** list, choose **Domain**.
- 4 Select Domain 1 only.
- 5 Click  **Create Selection**.

- 6 In the **Create Selection** dialog, type Air in the **Selection name** text field.
- 7 Click **OK**.

### ADD PHYSICS



- 1 In the **Home** toolbar, click  **Add Physics** to open the **Add Physics** window.
- 2 Go to the **Add Physics** window.
- 3 In the tree, select **Fluid Flow** > **Single-Phase Flow** > **Laminar Flow (spf)**.
- 4 Click the **Add to Component 1** button in the window toolbar.
- 5 In the **Home** toolbar, click  **Add Physics** to close the **Add Physics** window.

### LAMINAR FLOW (SPF)



Specify that the flow interface is active only in the air channel.

- 1 In the **Settings** window for **Laminar Flow**, locate the **Domain Selection** section.
- 2 From the **Selection** list, choose **Air**.

#### *Inlet 1*

- 1 In the **Physics** toolbar, click  **Boundaries** and choose **Inlet**.
- 2 Select Boundary 2 only.
- 3 In the **Settings** window for **Inlet**, locate the **Boundary Selection** section.
- 4 Click  **Create Selection**.
- 5 In the **Create Selection** dialog, type Inlet in the **Selection name** text field.
- 6 Click **OK**.
- 7 In the **Settings** window for **Inlet**, locate the **Boundary Condition** section.
- 8 From the list, choose **Fully developed flow**.
- 9 Locate the **Fully Developed Flow** section. In the  $U_{av}$  text field, type U0.

#### *Outlet 1*

- 1 In the **Physics** toolbar, click  **Boundaries** and choose **Outlet**.
- 2 Select Boundary 5 only.
- 3 In the **Settings** window for **Outlet**, locate the **Boundary Selection** section.
- 4 Click  **Create Selection**.
- 5 In the **Create Selection** dialog, type Outlet in the **Selection name** text field.
- 6 Click **OK**.

## HEAT TRANSFER IN SOLIDS AND FLUIDS (HT)

### *Heat Flux I*

The boundaries where the heat flux condition was applied are no longer exterior boundaries, so the heat flux condition cannot be applied. Instead, a continuity condition is applied by default between the solid and the fluid domains.

### *Fluid I*

- 1 In the **Model Builder** window, click **Fluid I**.
- 2 In the **Settings** window for **Fluid**, locate the **Domain Selection** section.
- 3 From the **Selection** list, choose **Air**.

### *Inflow I*

- 1 In the **Physics** toolbar, click  **Boundaries** and choose **Inflow**.
- 2 In the **Settings** window for **Inflow**, locate the **Boundary Selection** section.
- 3 From the **Selection** list, choose **Inlet**.
- 4 Locate the **Upstream Properties** section. From the  $T_{ustr}$  list, choose **Ambient temperature (ampri)**.



### *Outflow I*

- 1 In the **Physics** toolbar, click  **Boundaries** and choose **Outflow**.
- 2 In the **Settings** window for **Outflow**, locate the **Boundary Selection** section.
- 3 From the **Selection** list, choose **Outlet**.

## COMPONENT I (COMPI)

Now add the **Nonisothermal Flow** multiphysics feature to couple the **Heat Transfer in Solids and Fluids** and **Laminar Flow** interfaces. By doing this, you ensure in particular that the velocity field computed by the **Laminar Flow** interface is used by the **Fluid I** feature in the **Heat Transfer in Solids and Fluids** interface. In addition, the temperature dependence of the material properties in the flow interface is then defined from the temperature field computed by the **Heat Transfer in Solids and Fluids** interface.

### ADD MULTIPHYSICS

- 1 In the **Home** toolbar, click  **Add Multiphysics** to open the **Add Multiphysics** window.
- 2 Go to the **Add Multiphysics** window.
- 3 In the tree, select **Heat Transfer** > **Conjugate Heat Transfer** > **Laminar Flow**.
- 4 Click the **Add to Component** button in the window toolbar.
- 5 In the **Home** toolbar, click  **Add Multiphysics** to close the **Add Multiphysics** window.

## MESH 1



As this tutorial is intended to explore the heat transfer modeling capabilities, define a coarse mesh to speed up the computation. Note however that for accurate results, a finer mesh is needed.

- 1 In the **Settings** window for **Mesh**, locate the **Physics-Controlled Mesh** section.
- 2 From the **Element size** list, choose **Extremely coarse**.
- 3 In the table, clear the **Use** checkbox for **Geometric Analysis, Detail Size**.
- 4 In the **Home** toolbar, click  **Compute**.

The computation for this model takes a couple of minutes and about 2 GB of memory. The longer computational time is due to the extra degrees of freedom corresponding to the velocity, pressure, and temperature in the air domain.

Add a plot from the **Result Templates** showing temperature and velocity field and hide some walls from the display to make visible the temperature on the heat sink and on the channel walls and the flow structure.

## RESULT TEMPLATES

- 1 In the **Results** toolbar, click  **Result Templates** to open the **Result Templates** window.
- 2 Go to the **Result Templates** window.
- 3 In the tree, select **Study 1/Solution 1 (sol1) > Nonisothermal Flow 1 > Temperature and Fluid Flow (nitf1)**.
- 4 Click the **Add Result Template** button in the window toolbar.
- 5 In the **Results** toolbar, click  **Result Templates** to close the **Result Templates** window.

## GEOMETRY 1

- 1 Click the  **Click and Hide** button in the **Graphics** toolbar.
- 2 On the object **fin**, select Boundaries 1, 2, 4, and 5 only.

## RESULTS

### *Solid Temperature*

In the **Model Builder** window, expand the **Results > Temperature and Fluid Flow (nitf1)** node.

### *Filter 1*

- 1 In the **Model Builder** window, expand the **Results > Temperature and Fluid Flow (nitf1) > Fluid Flow** node, then click **Filter 1**.
- 2 In the **Settings** window for **Filter**, locate the **Element Selection** section.

**3** In the **Logical expression for inclusion** text field, type `spf.U>1.2*nitf1.Uave`.

**4** In the **Temperature and Fluid Flow (nitf1)** toolbar, click  **Plot**.

Duplicate this plot and keep only temperature subnodes to see better the temperature distribution.

#### *Temperature of the channel walls and heat sink*

**1** In the **Model Builder** window, right-click **Temperature and Fluid Flow (nitf1)** and choose **Duplicate**.

**2** In the **Settings** window for **3D Plot Group**, type *Temperature of the channel walls and heat sink* in the **Label** text field.

**3** Locate the **Color Legend** section. Clear the **Show units** checkbox.

#### *Fluid Flow*

**1** In the **Model Builder** window, expand the **Temperature of the channel walls and heat sink** node.

**2** Right-click **Fluid Flow** and choose **Delete**.

#### *Temperature of the channel walls and heat sink*

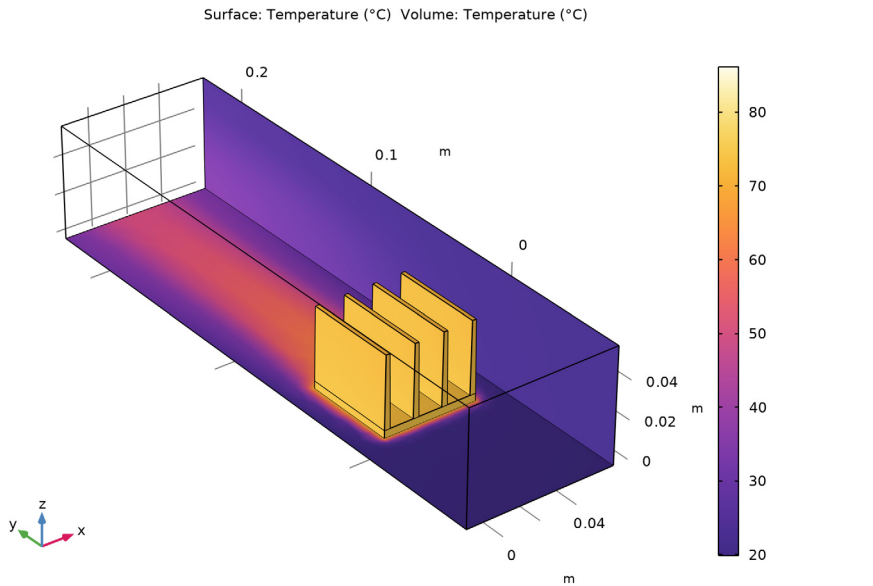

**1** In the **Model Builder** window, under **Results** click **Temperature of the channel walls and heat sink**.

- 2 In the **Temperature of the channel walls and heat sink** toolbar, click  **Plot**.



Now modify the model to include surface-to-surface radiation effects. First, add the **Surface-to-Surface Radiation** interface to the model. Then, study the effects of surface-to-surface radiation between the heat sink and the channel walls.

### ADD PHYSICS

- 1 In the **Home** toolbar, click  **Add Physics** to open the **Add Physics** window.
- 2 Go to the **Add Physics** window.
- 3 In the tree, select **Heat Transfer** > **Radiation** > **Surface-to-Surface Radiation (rad)**.
- 4 Click the **Add to Component 1** button in the window toolbar.
- 5 In the **Home** toolbar, click  **Add Physics** to close the **Add Physics** window.

### SURFACE-TO-SURFACE RADIATION (RAD)

- 1 In the **Settings** window for **Surface-to-Surface Radiation**, locate the **Boundary Selection** section.
- 2 From the **Selection** list, choose **Exterior boundaries without heat sink base (Heat Sink - Straight Fins 1)**.

- 3 To add the channel walls, click the **Paste Selection** button and type 1 3 4 44 (note that boundaries 1 and 4 have been hidden previously and are not visible in the graphics window).

The interface selection now contains boundaries 1, 3, 4, 6, 7, 9, 11–16, 22, 24–29, 31–35, 37, and 39–44.



By default the radiation direction is controlled by the opacity of the domains. The solid parts are automatically defined as opaque while the fluid parts are transparent. You can change this setting using the **Opacity** feature in the **Surface-to-Surface Radiation** interface.

When the **Diffuse Surface** boundary condition defines **Emitted radiation direction** as **Opacity controlled** (the default setting), the selected boundaries should be located between an opaque and a transparent domain. The exterior is defined as transparent by default. Change the default setting to make the exterior opaque and have the radiation direction automatically defined on the channel walls.



#### *Opacity*

- 1 In the **Physics** toolbar, click  **Domains** and choose **Opacity**.
- 2 In the **Settings** window for **Opacity**, locate the **Domain Selection** section.
- 3 From the **Selection** list, choose **All voids**.

#### *Diffuse Surface*

- 1 In the **Model Builder** window, click **Diffuse Surface 1**.
- 2 In the **Settings** window for **Diffuse Surface**, in the **Graphics** window toolbar, click  next to  **View Unhidden**, then choose **View All**.

### **ADD MULTIPHYSICS**

- 1 In the **Physics** toolbar, click  **Add Multiphysics** to open the **Add Multiphysics** window.
- 2 Go to the **Add Multiphysics** window.
- 3 In the tree, select **No Predefined Multiphysics Available for the Selected Physics Interfaces**.
- 4 Find the **Select the physics interfaces you want to couple** subsection. In the table, clear the **Couple** checkbox for **Laminar Flow (spf)**.
- 5 In the tree, select **Heat Transfer > Radiation > Heat Transfer with Surface-to-Surface Radiation**.
- 6 Click the **Add to Component** button in the window toolbar.
- 7 In the **Physics** toolbar, click  **Add Multiphysics** to close the **Add Multiphysics** window.

## MULTIPHYSICS

### *Heat Transfer with Surface-to-Surface Radiation 1 (htrd1)*

In the **Settings** window for **Heat Transfer with Surface-to-Surface Radiation**, in the **Graphics** window toolbar, click  next to **View Unhidden**, then choose **View Unhidden**.



## MATERIALS

### *Heat sink walls*

- 1 In the **Materials** toolbar, click  **Blank Material**.
- 2 In the **Settings** window for **Material**, type Heat sink walls in the **Label** text field.
- 3 Locate the **Geometric Entity Selection** section. From the **Geometric entity level** list, choose **Boundary**.
- 4 From the **Selection** list, choose **Exterior boundaries without heat sink base (Heat Sink - Straight Fins 1)**.
- 5 Locate the **Material Contents** section. In the table, enter the following settings:

Property	Variable	Value	Unit	Property group
Surface emissivity	epsilon_rad	0.9		Basic

### *Channel walls*

- 1 In the **Materials** toolbar, click  **Blank Material**.
- 2 In the **Settings** window for **Material**, type Channel walls in the **Label** text field.
- 3 Locate the **Geometric Entity Selection** section. From the **Geometric entity level** list, choose **Boundary**.
- 4 In the **Graphics** window toolbar, click  next to **View Unhidden**, then choose **View All**.
- 5 Select Boundaries 1, 3, 4, and 44 only.
- 6 In the **Graphics** window toolbar, click  next to **View Unhidden**, then choose **View Unhidden**.
- 7 Locate the **Material Contents** section. In the table, enter the following settings:

Property	Variable	Value	Unit	Property group
Surface emissivity	epsilon_rad	0.85		Basic

In order to keep the previous solution and to be able to compare it with this version of the model, add a second stationary study. And just before, edit the first study to exclude

surface-to-surface to make sure the same solution will be computed in case it is solved again.



### STUDY 1 WITHOUT RADIATION

- 1 In the **Model Builder** window, click **Study 1**.
- 2 In the **Settings** window for **Study**, type Study 1 Without Radiation in the **Label** text field.

#### *Step 1: Stationary*

- 1 In the **Model Builder** window, under **Study 1 Without Radiation** click **Step 1: Stationary**.
- 2 In the **Settings** window for **Stationary**, locate the **Physics and Variables Selection** section.
- 3 In the **Solve for** column of the table, under **Component 1 (comp1)**, clear the checkbox for **Surface-to-Surface Radiation (rad)**.
- 4 In the **Solve for** column of the table, under **Component 1 (comp1) > Multiphysics**, clear the checkbox for **Heat Transfer with Surface-to-Surface Radiation 1 (htrad1)**.

### ADD STUDY

- 1 In the **Study** toolbar, click  **Add Study** to open the **Add Study** window.
- 2 Go to the **Add Study** window.
- 3 Find the **Studies** subsection. In the **Select Study** tree, select **General Studies > Stationary**.
- 4 Right-click and choose **Add Study**.
- 5 In the **Study** toolbar, click  **Add Study** to close the **Add Study** window.

### STUDY 2 WITH RADIATION

- 1 In the **Settings** window for **Study**, type Study 2 With Radiation in the **Label** text field.
- 2 In the **Study** toolbar, click  **Compute**.

### RESULTS

#### *Transparency 1*

- 1 In the **Model Builder** window, expand the **Temperature (ht) 1** node.
- 2 Right-click **Volume 1** and choose **Transparency**.

### RESULTS

#### *Solid Temperature*

In the **Model Builder** window, expand the **Results > Temperature and Fluid Flow (nitf1) 1** node.

### *Filter 1*

- 1 In the **Model Builder** window, expand the **Results > Temperature and Fluid Flow (nitf1) 1 > Fluid Flow** node, then click **Filter 1**.
- 2 In the **Settings** window for **Filter**, locate the **Element Selection** section.
- 3 In the **Logical expression for inclusion** text field, type `spf.U>1.2*nitf1.Uave`.
- 4 In the **Temperature and Fluid Flow (nitf1) 1** toolbar, click  **Plot**.

### *Temperature of the channel walls and heat sink, with radiation*

- 1 In the **Model Builder** window, right-click **Temperature and Fluid Flow (nitf1) 1** and choose **Duplicate**.
- 2 In the **Settings** window for **3D Plot Group**, type **Temperature of the channel walls and heat sink, with radiation** in the **Label** text field.
- 3 Locate the **Color Legend** section. Clear the **Show units** checkbox.

### *Fluid Flow*

- 1 In the **Model Builder** window, expand the **Temperature of the channel walls and heat sink, with radiation** node.
- 2 Right-click **Fluid Flow** and choose **Delete**.

### *Temperature of the channel walls and heat sink, with radiation*

- 1 In the **Model Builder** window, under **Results** click **Temperature of the channel walls and heat sink, with radiation**.

2 In the **Temperature of the channel walls and heat sink, with radiation** toolbar, click

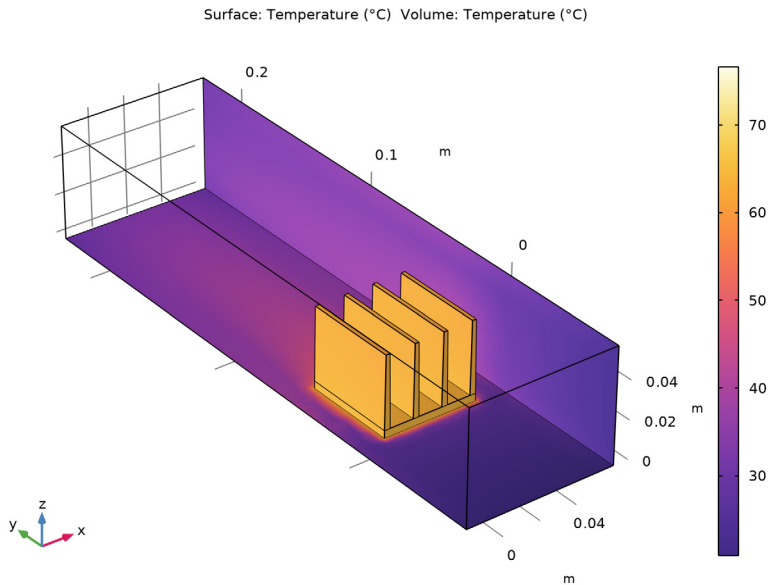

 **Plot.**



By comparing this plot with the previous temperature plot we observe that the heat transfer by radiation induces a significant cooling and that the maximum temperature is about 10°C lower when thermal radiation is accounted for.

In order to visualize the temperature on each side of the thermal contact, follow the next steps.

### RESULT TEMPLATES

- 1 In the **Results** toolbar, click  **Result Templates** to open the **Result Templates** window.
- 2 Go to the **Result Templates** window.
- 3 In the tree, select **Study 2 With Radiation/Solution 2 (sol2) > Heat Transfer in Solids and Fluids > Contact Temperature (ht)**.
- 4 Click the **Add Result Template** button in the window toolbar.
- 5 In the **Results** toolbar, click  **Result Templates** to close the **Result Templates** window.

## RESULTS

*Surface Slit 1*

- 1 In the **Model Builder** window, expand the **Results > Contact Temperature (ht)** node, then click **Surface Slit 1**.
- 2 In the **Contact Temperature (ht)** toolbar, click  **Plot**.