



Model created in COMSOL Multiphysics 6.4

# Tunnel Excavation

## Introduction

---

This example studies the behavior of soil during a tunnel excavation. The surface settlement and the width of the plastic region around the tunnel are important parameters required to predict the reinforcements needed during the excavation. This verification model is adapted from [Ref. 1](#) and [Ref. 2](#).

In situ stresses are computed in two steps. In a first study the stress state of the soil before excavation is computed. In the second study the elastoplastic behavior after soil removal is investigated. This requires incorporation of the stress response calculated in the first study. The soil removal is modeled using the **Activation** feature in the linear elastic material model.

In order to speed up the calculation the soil is considered to be elastic in the first step, and only in the second step, the Drucker–Prager soil plasticity model is added. The example is solved in 2D with plane strain conditions.

## Model Definition

---

The geometry consists of a soil layer that is 45 m deep and 90 m wide. A tunnel of 10 m in diameter is placed at the symmetry axis, 20 m below the surface. A bed rock, 45 m below the surface, constrains the displacement in the vertical direction, and a roller boundary is used to model the infinite extension of the soil in the lateral direction.

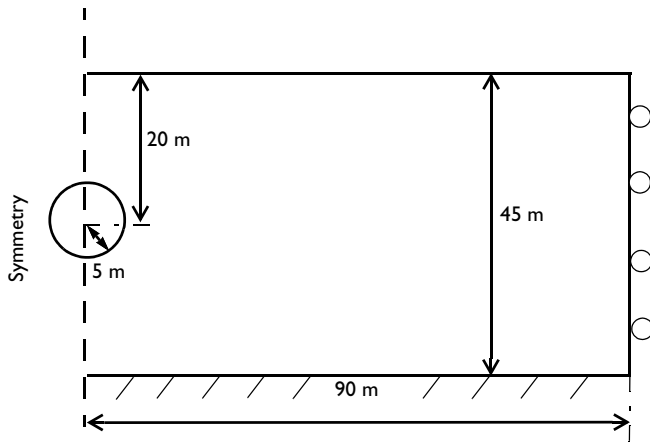

*Figure 1: Dimensions and boundary conditions for the tunnel excavation model.*

## SOIL PROPERTIES

The soil properties are adapted from [Ref. 2](#).

- Young's modulus,  $E = 12$  MPa and Poisson's ratio  $\nu = 0.495$ .
- Cohesion  $c = 130$  kPa and angle of internal friction  $\phi = 30^\circ$ .
- Use the Drucker–Prager criterion and match the material parameters to the Mohr–Coulomb criterion.

## CONSTRAINTS AND LOADS

- At the lower boundary, fix the displacement with a fixed constraint.
- Use a symmetry condition at the left boundary, and roller condition at the right boundary.
- Add a **Gravity** node to account for gravity effects.

## Results and Discussion

---

[Figure 2](#) shows the stress distribution due to gravity. The roller and symmetry boundaries create a linear vertical variation of the stress.

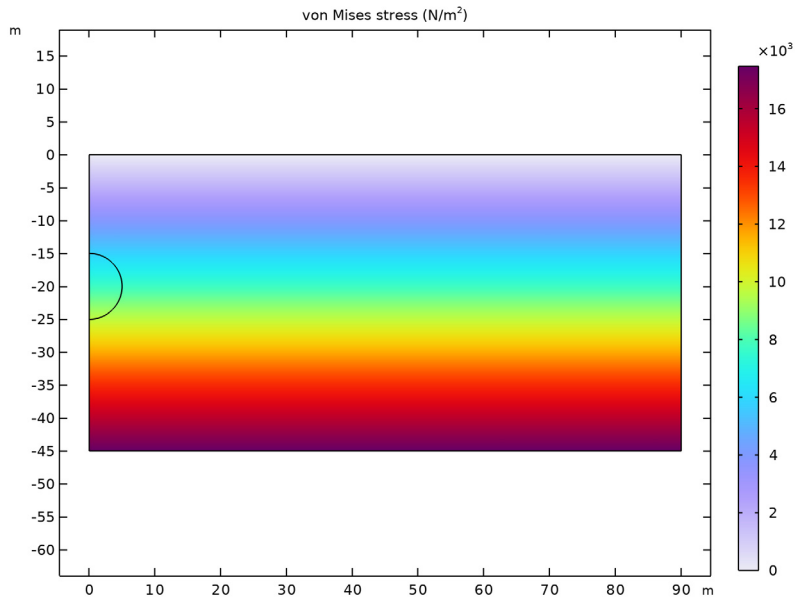

*Figure 2: von Mises stress in the soil layer before excavation.*

Figure 3 shows the stress distribution after excavating the tunnel. Note the stress increase at the tunnel wall.

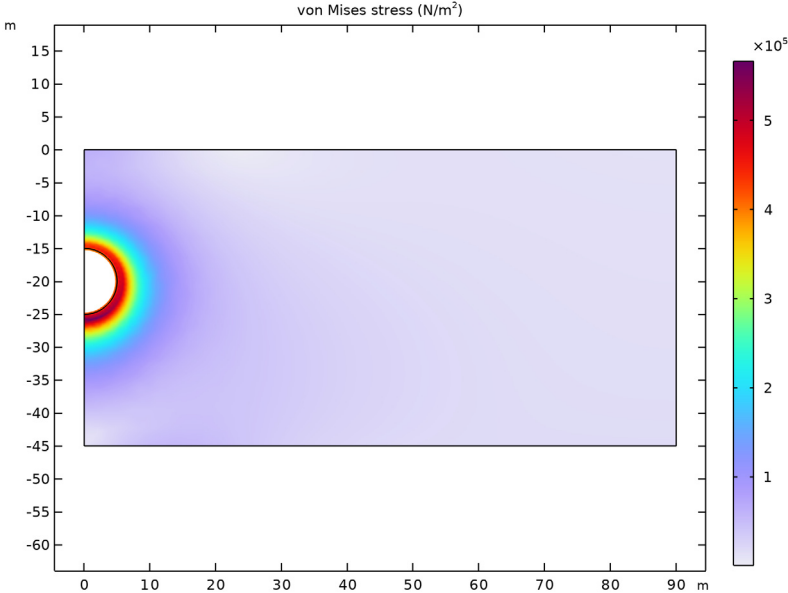
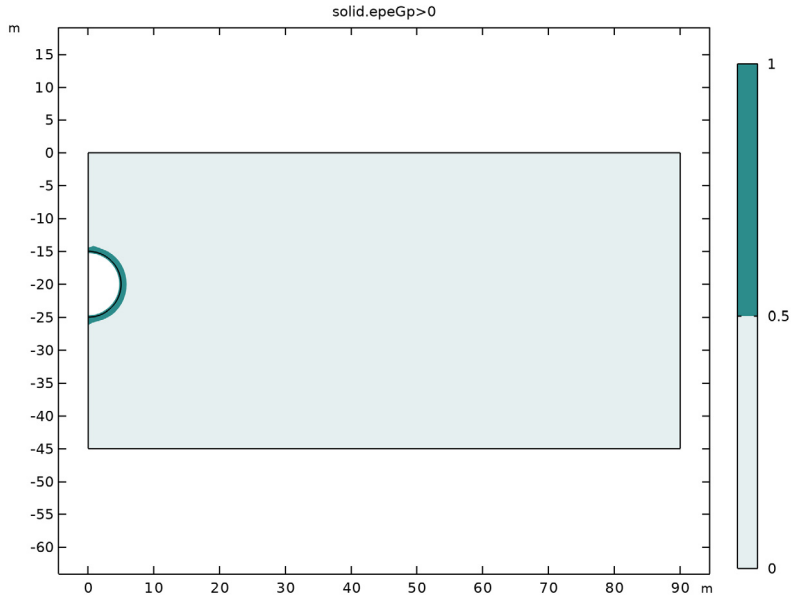

Figure 3: von Mises stress in the soil layer after excavation.

In the second step, besides removing the tunnel domain, a soil plasticity feature is included. In Figure 4, the region that experiences plastic deformation is shown.



*Figure 4: Plastic deformations occur near close to the tunnel wall.*

The horizontal displacement and the settlement of the top surface due to the excavation is shown in [Figure 5](#) and [Figure 6](#).

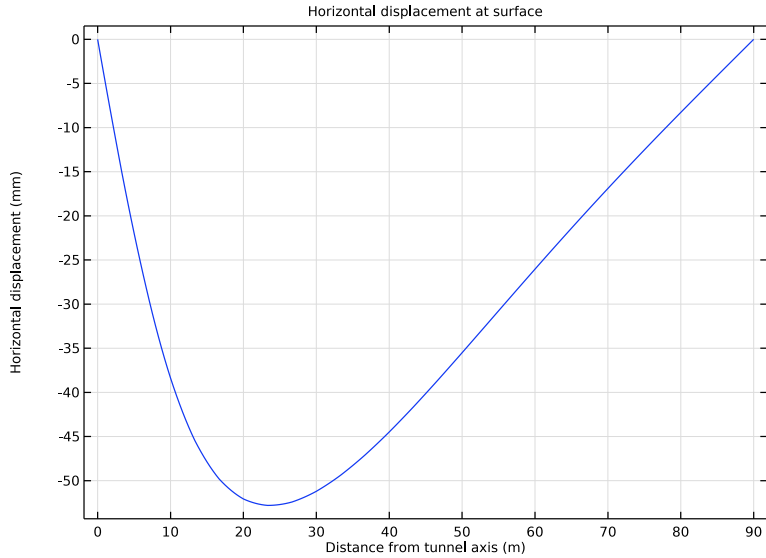

Figure 5: The horizontal displacement at the top surface.

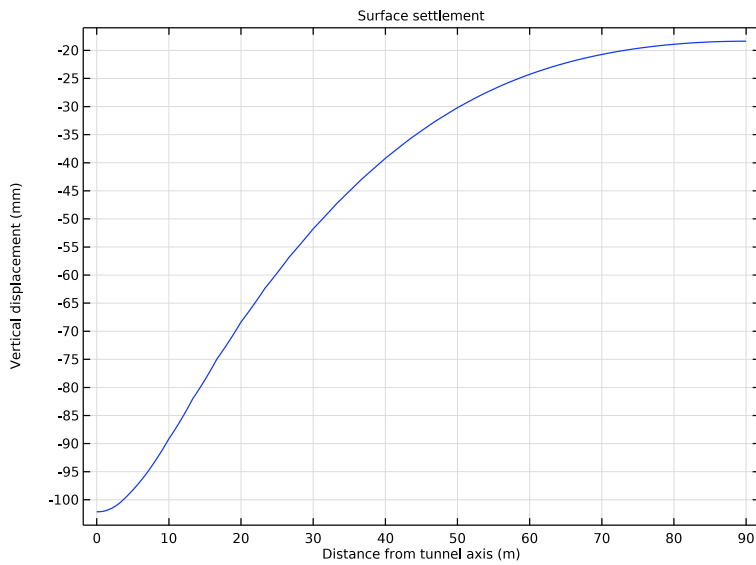

Figure 6: The surface settlement.

## References

---

1. D. Potts and L. Zdravkovic, *Finite Element Analysis in Geotechnical Engineering*, Thomas Telford Publishing, 2001.
2. H. Schweiger, “Results from Numerical Benchmark Exercises in Geotechnics,” *Proc. 5th European Conf. Numerical Methods in Geotechnical Eng.*, pp. 305–314, 2002.
3. F. Bocchi “Yield Surfaces and Plastic Flow Rules in Geomechanics,” COMSOL Blog, 16 Oct. 2014, [www.comsol.com/blogs/yield-surfaces-plastic-flow-rules-geomechanics/](http://www.comsol.com/blogs/yield-surfaces-plastic-flow-rules-geomechanics/).

---

**Application Library path:** Geomechanics\_Module/Soil/tunnel\_excavation

---

## Modeling Instructions



---

From the **File** menu, choose **New**.

### NEW

In the **New** window, click  **Model Wizard**.

### MODEL WIZARD

- 1 In the **Model Wizard** window, click  **2D**.
- 2 In the **Select Physics** tree, select **Structural Mechanics > Solid Mechanics (solid)**.
- 3 Click **Add**.
- 4 Click  **Study**.
- 5 In the **Select Study** tree, select **General Studies > Stationary**.
- 6 Click  **Done**.



### GEOMETRY I

#### Rectangle 1 (r1)

- 1 In the **Geometry** toolbar, click  **Rectangle**.
- 2 In the **Settings** window for **Rectangle**, locate the **Size and Shape** section.
- 3 In the **Width** text field, type 90.
- 4 In the **Height** text field, type 45.
- 5 Locate the **Position** section. In the **y** text field, type -45.

6 Click  **Build Selected**.

#### *Circle 1 (c1)*

- 1 In the **Geometry** toolbar, click  **Circle**.
- 2 In the **Settings** window for **Circle**, locate the **Size and Shape** section.
- 3 In the **Radius** text field, type 5.
- 4 In the **Sector angle** text field, type 180.
- 5 Locate the **Position** section. In the **y** text field, type -20.
- 6 Locate the **Rotation Angle** section. In the **Rotation** text field, type 270.
- 7 Click  **Build Selected**.

#### *Form Union (fin)*

- 1 In the **Model Builder** window, click **Form Union (fin)**.
- 2 In the **Settings** window for **Form Union/Assembly**, click  **Build Selected**.

Use the full geometry and a linear elastic material in the first step.

### **SOLID MECHANICS (SOLID)**

#### *Linear Elastic Material 1*

Since the Poisson's ratio is close to 0.5, use a mixed formulation to avoid locking effects.

- 1 In the **Model Builder** window, under **Component 1 (comp1) > Solid Mechanics (solid)** click **Linear Elastic Material 1**.
- 2 In the **Settings** window for **Linear Elastic Material**, locate the **Linear Elastic Material** section.
- 3 From the **Use mixed formulation** list, choose **Pressure formulation**.

#### *Symmetry 1*

- 1 In the **Physics** toolbar, click  **Boundaries** and choose **Symmetry**.
- 2 Select Boundaries 1 and 3–5 only.

#### *Fixed Constraint 1*

- 1 In the **Physics** toolbar, click  **Boundaries** and choose **Fixed Constraint**.
- 2 Select Boundary 2 only.

#### *Roller 1*

- 1 In the **Physics** toolbar, click  **Boundaries** and choose **Roller**.
- 2 Select Boundary 7 only.

### Gravity 1

In the **Physics** toolbar, click  **Global** and choose **Gravity**.

### Linear Elastic Material 1

In the **Model Builder** window, click **Linear Elastic Material 1**.

### Soil Plasticity 1

- 1 In the **Physics** toolbar, click  **Attributes** and choose **Soil Plasticity**.
- 2 In the **Settings** window for **Soil Plasticity**, locate the **Soil Plasticity Model** section.
- 3 From the **Match to Mohr–Coulomb** list, choose **Inscribe (plane strain)**.

Add an **Initial Stress and Strain** node and enable it only in the second study in order to get in situ stresses due to gravity.

### Linear Elastic Material 1

In the **Model Builder** window, click **Linear Elastic Material 1**.

### Initial Stress and Strain 1

- 1 In the **Physics** toolbar, click  **Attributes** and choose **Initial Stress and Strain**.
- 2 In the **Settings** window for **Initial Stress and Strain**, locate the **Initial Stress and Strain** section.
- 3 Specify the  $S_0$  matrix as

<code>withsol('sol1', solid.sx)</code>	<code>withsol('sol1', solid.sxy)</code>	<code>withsol('sol1', solid.sxz)</code>
<code>withsol('sol1', solid.sxy)</code>	<code>withsol('sol1', solid.sy)</code>	<code>withsol('sol1', solid.syz)</code>
<code>withsol('sol1', solid.sxz)</code>	<code>withsol('sol1', solid.syz)</code>	<code>withsol('sol1', solid.sz)</code>

Add an **Activation** node to the linear elastic material in order to model the soil removal. The activation expression set to zero in order to deactivate the material. The elastic stiffness of the soil material is multiplied by activation scale factor.

### Linear Elastic Material 1

In the **Model Builder** window, click **Linear Elastic Material 1**.

### Activation 1

- 1 In the **Physics** toolbar, click  **Attributes** and choose **Activation**.
- 2 Select Domain 2 only.
- 3 In the **Settings** window for **Activation**, locate the **Activation** section.

4 In the **Activation scale factor** text field, type 1e-9.

## MATERIALS

### Material 1 (mat1)

- 1 In the **Model Builder** window, under **Component 1 (comp1)** right-click **Materials** and choose **Blank Material**.
- 2 In the **Settings** window for **Material**, locate the **Material Contents** section.
- 3 In the table, enter the following settings:

Property	Variable	Value	Unit	Property group
Young's modulus	E	12 [MPa]	Pa	Young's modulus and Poisson's ratio
Poisson's ratio	nu	0.495	1	Young's modulus and Poisson's ratio
Density	rho	2000	kg/m <sup>3</sup>	Basic
Initial cohesion	cohesion0	130 [kPa]	Pa	Soil material
Friction angle	phis	30 [deg]	rad	Soil material

## MESH 1

### Free Triangular 1

In the **Mesh** toolbar, click  **Free Triangular**.

### Size

- 1 In the **Model Builder** window, click **Size**.
- 2 In the **Settings** window for **Size**, locate the **Element Size** section.
- 3 From the **Predefined** list, choose **Finer**.

### Distribution 1

- 1 In the **Model Builder** window, right-click **Free Triangular 1** and choose **Distribution**.
- 2 Select Boundaries 8 and 9 only.
- 3 In the **Settings** window for **Distribution**, locate the **Distribution** section.
- 4 In the **Number of elements** text field, type 12.

5 Click  **Build All**.

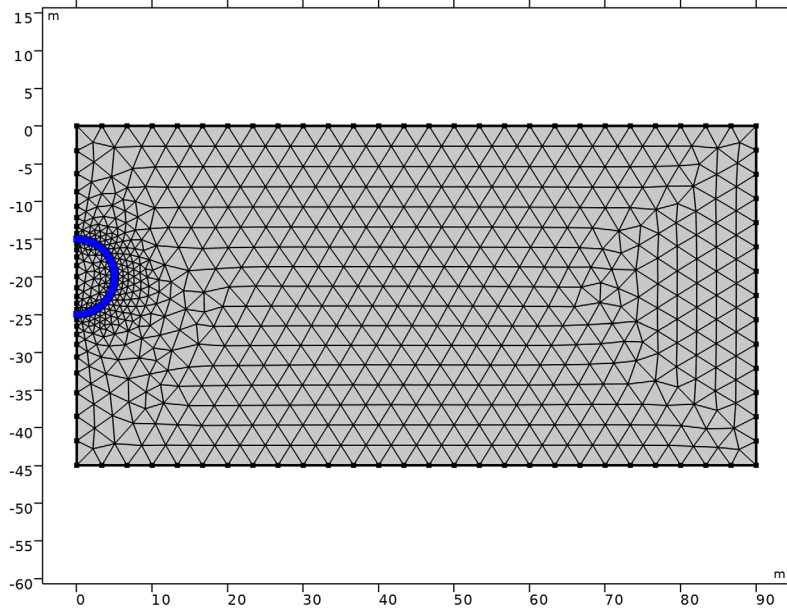

Use two stationary studies. The first one is used to compute the in situ stresses. The second study is used to compute the elastoplastic deformation due to the excavation of the tunnel.



#### **STUDY: BEFORE EXCAVATION**

- 1 In the **Model Builder** window, click **Study I**.
- 2 In the **Settings** window for **Study**, type Study: Before Excavation in the **Label** text field.

##### *Step 1: Stationary*

- 1 In the **Model Builder** window, under **Study: Before Excavation** click **Step 1: Stationary**.
- 2 In the **Settings** window for **Stationary**, locate the **Physics and Variables Selection** section.
- 3 Select the **Modify model configuration for study step** checkbox.
- 4 In the tree, select **Component 1 (comp1) > Solid Mechanics (solid) > Linear Elastic Material 1 > Soil Plasticity 1, Component 1 (comp1) > Solid Mechanics (solid) > Linear Elastic Material 1 > Initial Stress and Strain 1**, and **Component 1 (comp1) > Solid Mechanics (solid) > Linear Elastic Material 1 > Activation 1**.
- 5 Click  **Disable**.

## ADD STUDY

- 1 In the **Study** toolbar, click  **Add Study** to open the **Add Study** window.
- 2 Go to the **Add Study** window.
- 3 Find the **Studies** subsection. In the **Select Study** tree, select **General Studies > Stationary**.
- 4 Click the **Add Study** button in the window toolbar.
- 5 In the **Study** toolbar, click  **Add Study** to close the **Add Study** window.

## STUDY: AFTER EXCAVATION

In the **Settings** window for **Study**, type **Study: After Excavation** in the **Label** text field.

## STUDY: BEFORE EXCAVATION

In the **Study** toolbar, click  **Compute**.

## STUDY: AFTER EXCAVATION

Click  **Compute**.

## RESULTS



### *Stress: Before Excavation*

- 1 In the **Model Builder** window, under **Results** click **Stress (solid)**.
- 2 In the **Settings** window for **2D Plot Group**, type **Stress: Before Excavation** in the **Label** text field.

### *Surface 1*

In the **Model Builder** window, expand the **Stress: Before Excavation** node.

### *Deformation*

- 1 In the **Model Builder** window, expand the **Surface 1** node, then click **Deformation**.
- 2 In the **Settings** window for **Deformation**, locate the **Scale** section.
- 3 Select the **Scale factor** checkbox. In the associated text field, type 1.
- 4 In the **Stress: Before Excavation** toolbar, click  **Plot**.
- 5 Click the  **Zoom Extents** button in the **Graphics** toolbar.

The second default plot shows the von Mises stress in the soil after the tunnel excavation.

### *Stress: After Excavation*



- 1 In the **Model Builder** window, expand the **Results > Stress (solid) 1** node, then click **Stress (solid) 1**.

- 2 In the **Settings** window for **2D Plot Group**, type Stress: After Excavation in the **Label** text field.



#### *Deformation*

- 1 In the **Model Builder** window, expand the **Results > Stress: After Excavation > Surface 1** node, then click **Deformation**.
- 2 In the **Settings** window for **Deformation**, locate the **Scale** section.
- 3 Select the **Scale factor** checkbox. In the associated text field, type 1.

#### *Filter 1*

- 1 In the **Model Builder** window, click **Filter 1**.
- 2 In the **Settings** window for **Filter**, locate the **Element Selection** section.
- 3 From the **Element nodes to fulfill expression** list, choose **All**.
- 4 In the **Stress: After Excavation** toolbar, click  **Plot**.
- 5 Click the  **Zoom Extents** button in the **Graphics** toolbar.

### **RESULT TEMPLATES**

- 1 In the **Results** toolbar, click  **Result Templates** to open the **Result Templates** window.
- 2 Go to the **Result Templates** window.
- 3 In the tree, select **Study: After Excavation/Solution 2 (sol2) > Solid Mechanics > Equivalent Plastic Strain (solid)**.
- 4 Click the **Add Result Template** button in the window toolbar.
- 5 In the **Results** toolbar, click  **Result Templates** to close the **Result Templates** window.

### **RESULTS**

#### *Plastic Region: After Excavation*



In the **Settings** window for **2D Plot Group**, type Plastic Region: After Excavation in the **Label** text field.

#### *Surface 1*

- 1 In the **Model Builder** window, expand the **Plastic Region: After Excavation** node, then click **Surface 1**.
- 2 In the **Settings** window for **Surface**, locate the **Expression** section.
- 3 In the **Expression** text field, type `solid.epεGp>0`.  
This is a boolean expression which is 1 in the plastic region and 0 elsewhere.
- 4 Clear the **Description** checkbox.

- 5 Locate the **Coloring and Style** section. In the **Number of bands** text field, type 2.

#### *Deformation 1*

- 1 Right-click **Surface 1** and choose **Deformation**.
- 2 In the **Settings** window for **Deformation**, locate the **Scale** section.
- 3 Select the **Scale factor** checkbox. In the associated text field, type 1.
- 4 In the **Plastic Region: After Excavation** toolbar, click  **Plot**.
- 5 Click the  **Zoom Extents** button in the **Graphics** toolbar.

#### *Plastic Region: After Excavation*

- 1 In the **Model Builder** window, under **Results** click **Plastic Region: After Excavation**.
- 2 In the **Settings** window for **2D Plot Group**, click to expand the **Selection** section.
- 3 From the **Geometric entity level** list, choose **Domain**.
- 4 Select Domain 1 only.
- 5 In the **Plastic Region: After Excavation** toolbar, click  **Plot**.

#### *Horizontal Displacement: After Excavation*

- 1 In the **Results** toolbar, click  **ID Plot Group**.
- 2 In the **Settings** window for **ID Plot Group**, type Horizontal Displacement: After Excavation in the **Label** text field.
- 3 Locate the **Data** section. From the **Dataset** list, choose **Study: After Excavation/ Solution 2 (sol2)**.
- 4 Click to expand the **Title** section. From the **Title type** list, choose **Manual**.
- 5 In the **Title** text area, type Horizontal displacement at surface.
- 6 Locate the **Plot Settings** section.
- 7 Select the **x-axis label** checkbox. In the associated text field, type Distance from tunnel axis (m).
- 8 Select the **y-axis label** checkbox. In the associated text field, type Horizontal displacement (mm).

#### *Line Graph 1*

- 1 Right-click **Horizontal Displacement: After Excavation** and choose **Line Graph**.
- 2 Select Boundary 6 only.
- 3 In the **Settings** window for **Line Graph**, locate the **y-Axis Data** section.
- 4 In the **Expression** text field, type u.
- 5 From the **Unit** list, choose **mm**.

**6** In the **Horizontal Displacement: After Excavation** toolbar, click  **Plot**.

*Vertical Displacement: After Excavation*

- 1** In the **Model Builder** window, right-click **Horizontal Displacement: After Excavation** and choose **Duplicate**.
- 2** In the **Settings** window for **ID Plot Group**, type **Vertical Displacement: After Excavation** in the **Label** text field.
- 3** Locate the **Title** section. In the **Title** text area, type **Surface settlement**.
- 4** Locate the **Plot Settings** section. In the **y-axis label** text field, type **Vertical displacement (mm)**.

*Line Graph 1*

- 1** In the **Model Builder** window, expand the **Vertical Displacement: After Excavation** node, then click **Line Graph 1**.
- 2** In the **Settings** window for **Line Graph**, locate the **y-Axis Data** section.
- 3** In the **Expression** text field, type **v**.
- 4** In the **Vertical Displacement: After Excavation** toolbar, click  **Plot**.