



Model created in COMSOL Multiphysics 6.4

Wire Electrode

Introduction

One of the most important aspects in the design of electrochemical cells is the current density distributions in the electrolyte and electrodes. Nonuniform current density distributions can be detrimental for the operation of electrochemical processes. In many cases the parts of an electrode that are subjected to high current density degrade at a faster rate. Knowledge of the current density distribution is also desired to optimize the utilization of the electrocatalysts, because these are often made of expensive noble metals. Nonuniform deposition and consumption, as well as unnecessarily high overvoltages, with resulting energy losses and possibly unwanted side-reactions, may be other effects that one would like to minimize.

This example models the *primary, secondary, and tertiary current density distributions* (Ref. 1) of an arbitrary electrochemical cell. It successively goes through the different classes of current density distributions so as to also show how complexity should be gradually introduced when modeling electrochemical cells.

The same geometry is considered in all three cases: a wire electrode structure is placed between two flat electrode surfaces, and in the open volume between the wire and the flat surfaces electrolyte is allowed to flow; see [Figure 1](#). The electrochemical cell can be seen as a unit cell of a larger wire-mesh electrode — an electrochemical cell setup common for many large-scale industrial processes.

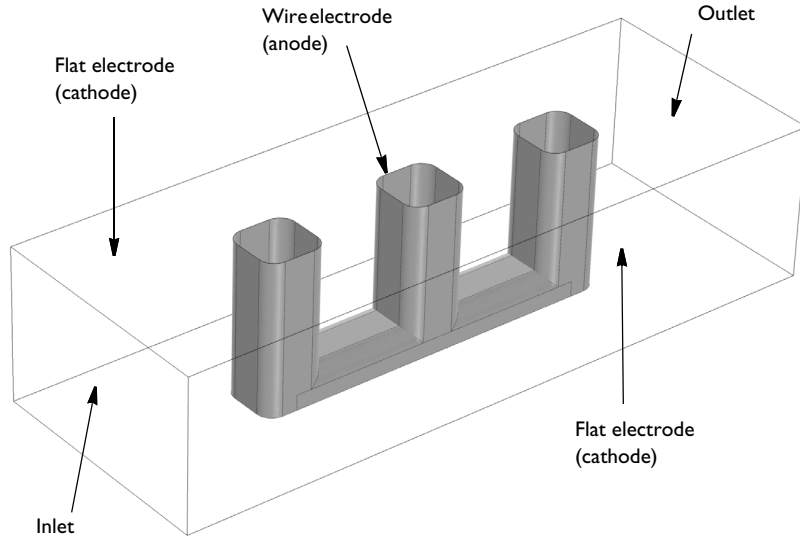

Figure 1: Modeled electrochemical cell. Wire electrode (anode) between two flat electrodes (cathodes). Flow inlet to the left, outlet to the right. The top and bottom flat surfaces are inert.

Model Definition

PRIMARY CURRENT DISTRIBUTION

Figure 1 shows the investigated geometry. Firstly, this example considers primary current density distribution. This is the situation where the mixing of electrolyte is vigorous or where concentration gradients are small, so that ionic migration is the dominating transport mechanism. The general mass balance in the electrolyte, assuming steady-state conditions and that no homogeneous reactions occur, is given by

$$\nabla \cdot \mathbf{N}_i = 0$$

where \mathbf{N}_i is the flux of species i (SI unit: $\text{mol} \cdot \text{m}^2/\text{s}$), which in turn is governed by:

$$-D_i \nabla c_i - z_i m_i F c_i \nabla \phi_i + c_i \mathbf{u} = \mathbf{N}_i \quad (1)$$

where c_i represents the concentration of the ion i (SI unit: mol/m^3), z_i its valence, D_i its diffusivity (SI unit: m^2/s), m_i its mobility (SI unit: $\text{mol} \cdot \text{m}^2(\text{s} \cdot \text{V} \cdot \text{A})$), F denotes the Faraday constant (SI unit: As/mol), ϕ_i the ionic potential, and \mathbf{u} the velocity vector (SI unit: $\text{m}/$

s). The components operated upon by the above transport equation are often described as the diffusion, migration, and convection transport mechanisms. The net current density can be described through:

$$\mathbf{i} = -F \sum z_i \mathbf{N}_i$$

where i is the current density vector (SI unit: A/m²). Combining the three above equations, while assuming electroneutrality (which removes the convection term) and negligible concentration gradients (which removes diffusion) leaves:

$$\mathbf{i} = -F \sum -z_i^2 m_i F c_i \nabla \phi_l$$

Current density is conserved throughout:

$$\nabla \cdot \mathbf{i} = 0 \quad (2)$$

so that by combining the valence, ionic mobility, constant concentration and the Faraday constant to a representative conductivity, κ (SI unit: S/m)), [Equation 2](#) becomes:

$$\nabla \cdot (-\kappa \nabla \phi_l) = 0 \quad (3)$$

This final equation is equivalent to Ohm's Law.

The boundary conditions for the case of primary current density distribution assume that the kinetics on the electrode surfaces are fast, which allow the assumption of constant potential on these surfaces (all other boundaries are insulated). The solid phase (electronic conductor) potential on the cathode, $\phi_{s,c}$ (SI unit: V), is a convenient choice of reference potential in the system:

$$\phi_{s,c} = 0$$

The electrode potential equals the difference between the potential of solid phase in the electrode, ϕ_s , and the potential in the adjacent electrolyte, ϕ_l :

$$E_{\text{electrode}} = \phi_s - \phi_l$$

In the absence of kinetic losses, the cathode potential, E_c , equals the equilibrium potential, $E_{\text{eq},c}$:

$$E_{\text{eq},c} = \phi_{s,c} - \phi_{l,c} = -\phi_{l,c}$$

which sets the boundary condition for the cathode.

The potential difference over the whole cell, E_{cell} , is defined as the potential difference between the solid phases of the two electrodes

$$E_{\text{cell}} = \phi_{s,a} - \phi_{s,c} = \phi_{s,a}$$

In this way the boundary condition for the ionic potential at the anode can be set via

$$E_{\text{eq},a} = \phi_{s,a} - \phi_{l,a} = E_{\text{cell}} - \phi_{l,a}$$

SECONDARY CURRENT DISTRIBUTION

Secondary current distribution takes into account the kinetics at the electrodes. Mixing is supposed to be good and the electroneutrality condition still relevant so that Ohm's Law remains a good description for the equations in the domain. Yet the electrochemical reactions are no longer fast enough that a constant potential can be applied at the electrodes. The properties of the chemical species and their ability to react at the surface, that is, the reaction driving forces (overvoltages), need to be considered.

In this model, the expressions for the local current density, i (SI unit: A/m^2), is based on the Butler–Volmer equation (Ref. 2) for a single electron reaction. For the secondary current distribution case (that is, without concentration dependence) it reads:

$$i_{\text{loc}} = i_0(\exp(\eta(1 - \beta)F/(RT)) - \exp(\eta\beta F/(RT)))$$

here T is the temperature and R is the gas constant (SI unit: $\text{J}/(\text{K}\cdot\text{mol})$). i_0 , the exchange current density, (SI unit: A/m^2), and β , the symmetry factor, are reaction and electrode dependent and are therefore different for each electrode. The overpotential, η , is the difference between the electrode potential and the equilibrium potential for the electrode reaction, defined in the following way:

$$\eta = E_{\text{electrode}} - E_{\text{eq}}$$

This results in the following expressions for the overpotentials for the cathode and anode, respectively:

$$\eta_c = -\phi_{l,c} - E_{\text{eq},c}$$

$$\eta_a = E_{\text{cell}} - \phi_{l,a} - E_{\text{eq},a}$$

TERTIARY CURRENT DISTRIBUTION

In tertiary current density distribution, mass transport through diffusion, convection, and migration has to be considered (that is, all components of Equation 1).

For the net ionic charge transport the assumption for this model still is electroneutrality and a supporting electrolyte with negligible concentration gradients, which means that the potential distribution in the electrolyte can be described by Ohm's Law (Equation 3).

To introduce a mass-transport dependence in this model the species being oxidized at the anode now has mass transport limitations and its localized concentration, c (SI unit: mol/m³), affects the electrode kinetics. The anodic branch of the Butler–Volmer expression at the anode therefore gets a concentration dependence, and the expression now reads

$$i_a = i_0 \left(\frac{c}{c_0} \exp(\eta(1 - \beta)F/(RT)) - \exp(\eta\beta F/(RT)) \right) \quad (4)$$

Here c_0 (SI unit: mol/m³) denotes a reference concentration (equal to the inlet concentration). Equation 4 is applied to the wire (anode) electrode, while the cathodes keep the expression for the local current density from the secondary current distribution model.

Also a momentum balance is introduced to describe the convection. In this case, the assumption is a stationary laminar incompressible flow, using the Navier–Stokes equation

$$\begin{aligned} -\nabla \cdot \mu(\nabla \mathbf{u} + (\nabla \mathbf{u})^T) + \rho(\mathbf{u} \cdot \nabla) \mathbf{u} + \nabla p &= 0 \\ \nabla \cdot \mathbf{u} &= 0 \end{aligned} \quad (5)$$

where μ is the dynamic viscosity (SI unit: Ns/m²), ρ the density (SI unit: kg/m³) and p the pressure (SI unit: Pa).

No Slip boundary conditions are applied to the electrode surfaces, and slip boundary conditions to the top and bottom to account for the periodically repeating unit cell in this spatial direction. At the inlet, a laminar inflow with a fixed mean velocity is specified, whereas a pressure condition specifying a zero reference pressure is used at the outlet.

Finally, Equation 1 accounts for the mass transport of the reacting species:

$$\nabla \cdot (-D\nabla c - z m F c \nabla \phi + c \mathbf{u}) = 0 \quad (6)$$

No-flux boundary conditions are applied for all boundaries except for the inlet, outlet and the anode. At the inlet, a fixed concentration is specified. Outflow conditions are applied for the outlet. Faraday's law is used to specify the net molar flux at the anode where the species is consumed:

$$N_a = -\frac{i_a}{F}$$

Results and Discussion

Figure 2 shows the different polarization plots that results from using a parametric solver to solve for all the three cases of current distribution. The total current decreases as potential losses due to kinetics and mass transport are introduced in the model. The following sections cover each case more in detail.

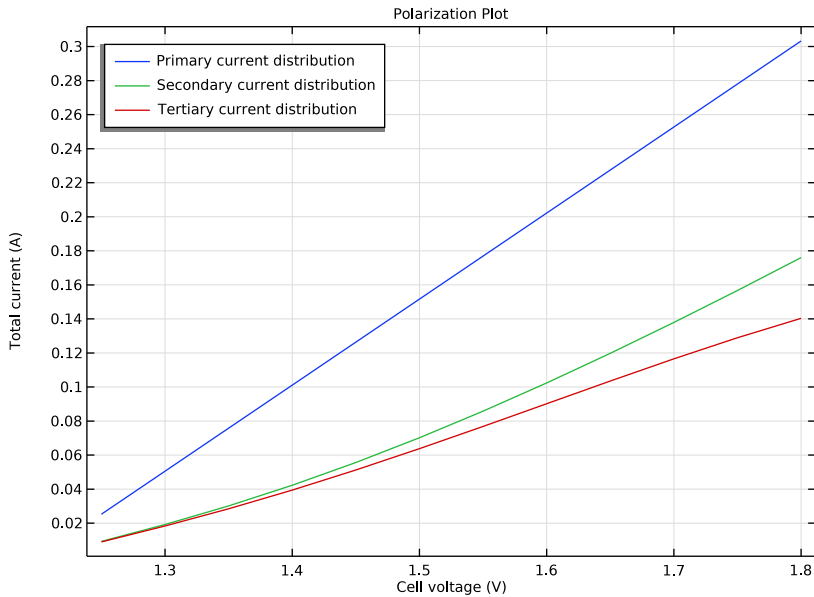

Figure 2: Polarization plots comparing the three cases of current distribution.

PRIMARY CURRENT DISTRIBUTION

Figure 3 shows the potential distribution in the electrolyte and current density distribution at the anode and posterior cathode at a cell voltage of 1.45 V. To clearly show the anode, the front cathode is hidden. On the anode, the current density distribution is highest at the corners of the wires and close to zero at the central parts of the wire structure. The current distribution on the cathode is significantly more even.

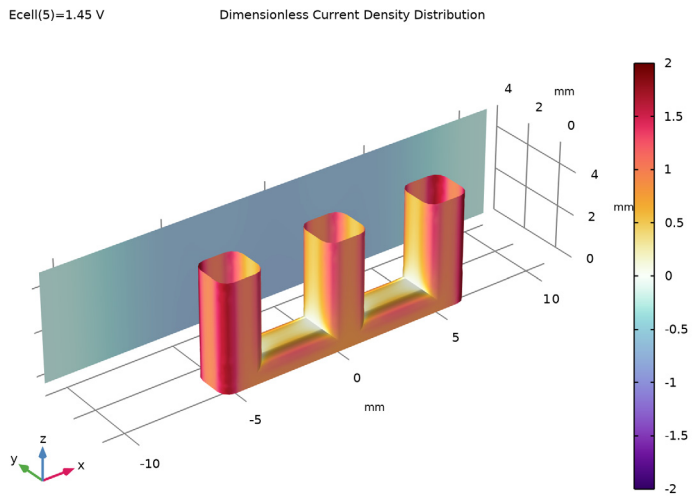
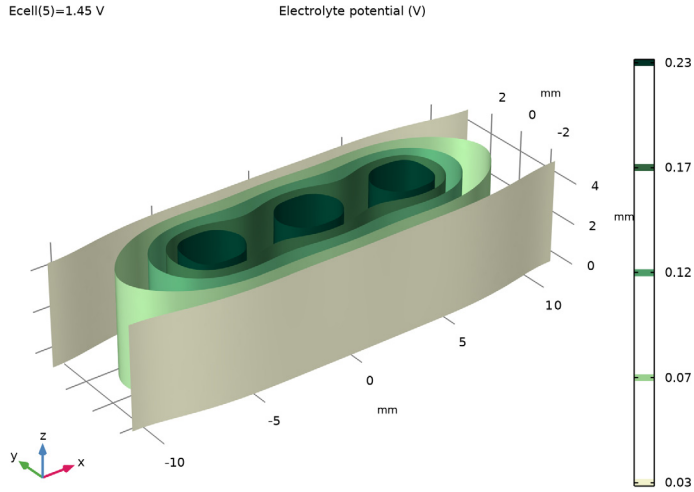

Figure 3: Primary current distribution, $E_{cell} = 1.45$ V. Potential distribution in the electrolyte (top) and current density distribution on the anode and posterior cathode (bottom).

SECONDARY CURRENT DISTRIBUTION

Figure 4 shows the plots for the secondary current distribution. A higher cell voltage is chosen reach a total cell current comparable to Figure 3. Compared to the primary current

distribution the secondary current distribution is smoother. The reason is that a high local current density induces local overpotential losses on the electrode surface.

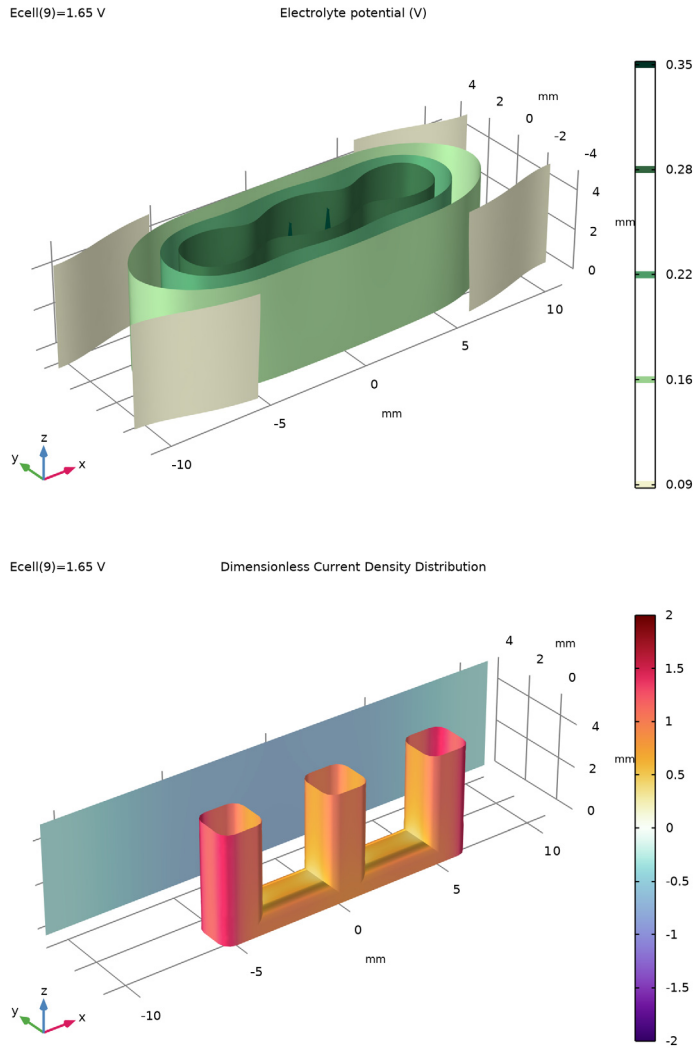

Figure 4: Secondary current distribution, $E_{cell} = 1.65$ V. Potential distribution in the electrolyte (top) and current density distribution on the anode and posterior cathode (bottom).

TERTIARY CURRENT DISTRIBUTION

Figure 5 shows the flow velocity magnitude of the flow and the concentration of the reactant at 1.8 V. The convective flow is close to zero between the wires, and this results in a depletion zone with low concentration in these parts in the cell.

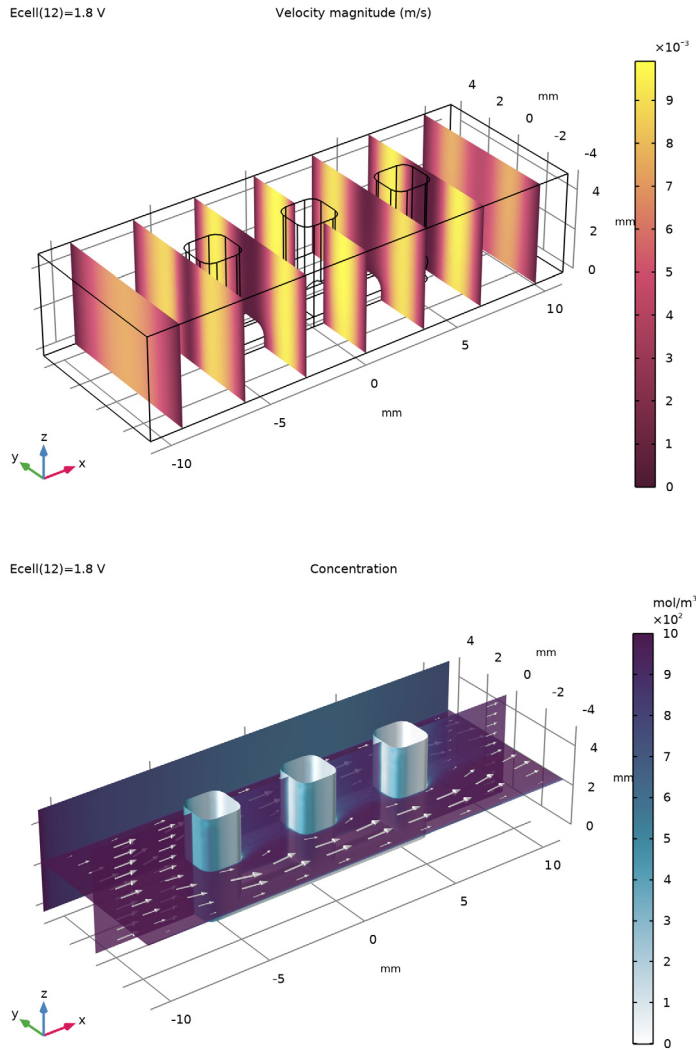

Figure 5: Flow field (top: slice plot, bottom: arrows) and concentration profile (bottom: slices and anode and posterior cathode surfaces) at 1.8 V.

Figure 6 shows the resulting potential and current density distribution. The low concentration between the wires now severely impacts the smoothness of the current distribution.

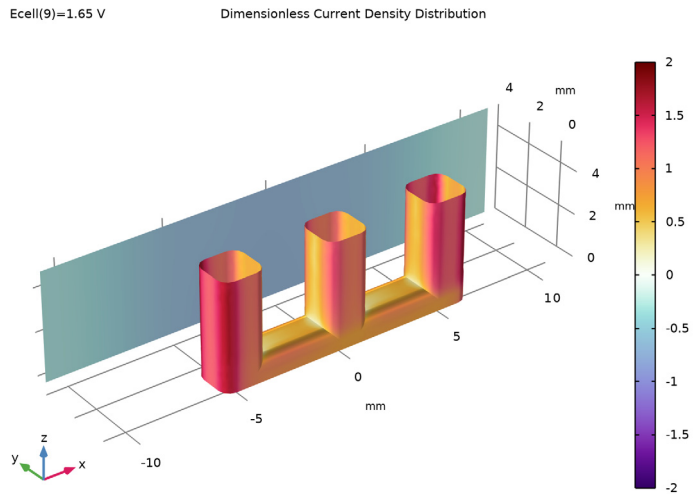
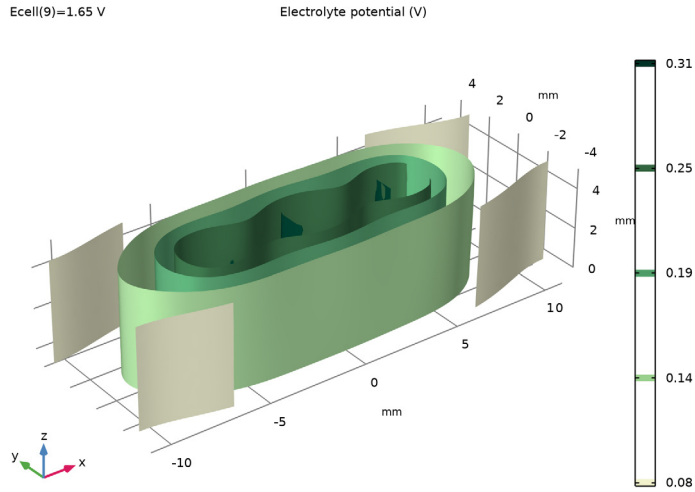

Figure 6: Tertiary current distribution, $E_{cell} = 1.65$ V. Potential distribution in the electrolyte (top) and current density distribution on the anode and posterior cathode (bottom).

Notes About the COMSOL Implementation

The model is set up using the following physics interfaces:

- Primary Current Distribution for modeling the electrolyte potential, governed by Ohm's Law (Equation 3). The secondary and tertiary current distributions are modeled by changing the current distribution type of the interface to Secondary.
- Transport of Diluted Species for the mass transport of the reacting species (Equation 6).
- Laminar Flow for the momentum balance to describe the convection (Equation 5).

References

1. J.S. Newman, *Electrochemical Systems*, 2nd ed., Prentice Hall, NJ, 1990.
2. J. O'M. Bockris and A.K.N. Reddy, *Modern Electrochemistry*, Plenum Press, NY, 1970.

Application Library path: Fuel_Cell_and_Electrolyzer_Module/Electrolyzers/wire_electrode



Modeling Instructions

From the **File** menu, choose **New**.

NEW

In the **New** window, click  **Model Wizard**.

MODEL WIZARD

- 1 In the **Model Wizard** window, click  **3D**.
- 2 In the **Select Physics** tree, select **Electrochemistry** > **Primary and Secondary Current Distribution** > **Primary Current Distribution (cd)**.
- 3 Click **Add**.
- 4 Click  **Study**.
- 5 In the **Select Study** tree, select **General Studies** > **Stationary**.
- 6 Click  **Done**.

GEOMETRY I

The model geometry is available as a parameterized geometry sequence in a separate MPH file. If you want to build it from scratch, follow the instructions in the section [Appendix — Geometry Modeling Instructions](#). Otherwise load it from file with the following steps.

- 1 In the **Geometry** toolbar, click **Insert Sequence** and choose **Insert Sequence**.
- 2 Browse to the model's Application Libraries folder and double-click the file `wire_electrode_geom_sequence.mph`.
- 3 In the **Geometry** toolbar, click  **Build All**.

GLOBAL DEFINITIONS

Now start defining the physics for the primary current distribution simulation. Begin with the model parameters.

Parameters I



- 1 In the **Model Builder** window, under **Global Definitions** click **Parameters I**.
- 2 In the **Settings** window for **Parameters**, locate the **Parameters** section.
- 3 In the table, enter the following settings:

Name	Expression	Value	Description
Ecell	1.3[V]	1.3 V	Cell voltage
Eeq_c	0[V]	0 V	Cathode equilibrium potential
Eeq_a	1.2[V]	1.2 V	Anode equilibrium potential

MATERIALS

Add water from the material library. Modify the material by adding the conductivity value.

ADD MATERIAL

- 1 In the **Materials** toolbar, click  **Add Material** to open the **Add Material** window.
- 2 Go to the **Add Material** window.
- 3 In the tree, select **Built-in > Water, liquid**.
- 4 Click the **Add to Component** button in the window toolbar.
- 5 In the **Materials** toolbar, click  **Add Material** to close the **Add Material** window.

MATERIALS

Electrolyte

- 1 In the **Settings** window for **Material**, type `Electrolyte` in the **Label** text field.

2 Locate the **Material Contents** section. In the table, enter the following settings:



Property	Variable	Value	Unit	Property group
Electrolyte conductivity	sigma_iso ; sigma_ii = sigma_iso, sigma_ij = 0	10 [S/m]	S/m	Electrolyte conductivity

PRIMARY CURRENT DISTRIBUTION (CD)

Electrolyte 1

Now start setting up the physics. Only the equilibrium potentials and the electrode potential boundary values need to be set for the primary current distribution.



Electrode Surface 1

- 1 In the **Physics** toolbar, click  **Boundaries** and choose **Electrode Surface**.
- 2 Select Boundaries 2 and 5 only.
Create selections for these cathodes. The selection will be used later when setting up more physics, meshing, and postprocessing.
- 3 In the **Settings** window for **Electrode Surface**, locate the **Boundary Selection** section.
- 4 Click  **Create Selection**.
- 5 In the **Create Selection** dialog, type Cathodes in the **Selection name** text field.
- 6 Click **OK**.

Electrode Reaction 1

- 1 In the **Model Builder** window, click **Electrode Reaction 1**.
- 2 In the **Settings** window for **Electrode Reaction**, locate the **Equilibrium Potential** section.
- 3 In the E_{eq} text field, type Eeq_c.

Electrode Surface 2

- 1 In the **Physics** toolbar, click  **Boundaries** and choose **Electrode Surface**.
- 2 Select Boundaries 6–51 only.
This selection is easiest to achieve with the 'paste selection' button.
- 3 In the **Settings** window for **Electrode Surface**, locate the **Boundary Selection** section.
- 4 Click  **Create Selection**.
- 5 In the **Create Selection** dialog, type Anode in the **Selection name** text field.
- 6 Click **OK**.

7 In the **Settings** window for **Electrode Surface**, locate the **Electrode Phase Potential Condition** section.

8 In the $\phi_{s,ext}$ text field, type Ecell.

Electrode Reaction 1

1 In the **Model Builder** window, click **Electrode Reaction 1**.

2 In the **Settings** window for **Electrode Reaction**, locate the **Equilibrium Potential** section.

3 In the E_{eq} text field, type Eeq_a.

Initial Values 1

Also, provide initial values for the electrolyte potential.

1 In the **Model Builder** window, under **Component 1 (comp1) > Primary Current Distribution (cd)** click **Initial Values 1**.

2 In the **Settings** window for **Initial Values**, locate the **Initial Values** section.

3 In the *phil* text field, type (Ecell-Eeq_a-Eeq_c)/2.

MESH 1

The following steps create a mesh with boundary layers adjacent to the anode and cathode surfaces. This is a convenient way of increasing the number of mesh elements close to a surface of special interest.

Boundary Layers 1

In the **Mesh** toolbar, click  **Boundary Layers**.

Boundary Layer Properties

1 In the **Model Builder** window, click **Boundary Layer Properties**.

2 In the **Settings** window for **Boundary Layer Properties**, locate the **Geometric Entity Selection** section.

3 From the **Selection** list, choose **Anode**.

4 Locate the **Layers** section. In the **Number of layers** text field, type 6.

5 In the **Stretching factor** text field, type 1.3.

6 From the **Thickness specification** list, choose **First layer**.

7 In the **Thickness** text field, type $2e-5$ [m].

Boundary Layer Properties 1

1 In the **Mesh** toolbar, click  **More Attributes** and choose **Boundary Layer Properties**.

- 2 In the **Settings** window for **Boundary Layer Properties**, locate the **Boundary Selection** section.
- 3 From the **Selection** list, choose **Cathodes**.
- 4 Locate the **Layers** section. In the **Number of layers** text field, type 2.
- 5 In the **Stretching factor** text field, type 1.3.
- 6 In the **Thickness adjustment factor** text field, type 5.

Size

- 1 In the **Model Builder** window, under **Component 1 (comp1) > Mesh 1** click **Size**.
- 2 In the **Settings** window for **Size**, locate the **Element Size** section.
- 3 From the **Calibrate for** list, choose **Fluid dynamics**.

DEFINITIONS

Before solving, create some component couplings to be used when analyzing the results.

Integration 1 (intop1)

- 1 In the **Definitions** toolbar, click  **Nonlocal Couplings** and choose **Integration**.
- 2 In the **Settings** window for **Integration**, type anode_int in the **Operator name** text field.
- 3 Locate the **Source Selection** section. From the **Geometric entity level** list, choose **Boundary**.
- 4 From the **Selection** list, choose **Anode**.

Average 1 (aveop1)

- 1 In the **Definitions** toolbar, click  **Nonlocal Couplings** and choose **Average**.
- 2 In the **Settings** window for **Average**, type anode_avg in the **Operator name** text field.
- 3 Locate the **Source Selection** section. From the **Geometric entity level** list, choose **Boundary**.
- 4 From the **Selection** list, choose **Anode**.

STUDY 1

The model is now ready for solving. Add an auxiliary continuation sweep to solve for a range of cell potentials.

Step 1: Stationary

- 1 In the **Model Builder** window, under **Study 1** click **Step 1: Stationary**.
- 2 In the **Settings** window for **Stationary**, click to expand the **Study Extensions** section.
- 3 Select the **Auxiliary sweep** checkbox.

4 Click  **Add**.

5 In the table, enter the following settings:

Parameter name	Parameter value list	Parameter unit
Ecell (Cell voltage)	range(1.25,0.05,1.8)	V

6 In the **Model Builder** window, click **Study 1**.

7 In the **Settings** window for **Study**, locate the **Study Settings** section.

8 Clear the **Generate default plots** checkbox.

9 In the **Study** toolbar, click  **Compute**.

You have now solved the primary current distribution model.

Solution 1 (sol1)

To store this particular primary current distribution solution from the latest computation, copy and store the solution in order to compare with these results later when you modify the model.

1 In the **Model Builder** window, expand the **Study 1 > Solver Configurations** node.

2 Right-click **Solution 1 (sol1)** and choose **Solution > Copy**.

Primary Current Distribution

1 In the **Model Builder** window, under **Study 1 > Solver Configurations** click **Solution 1 - Copy 1 (sol2)**.

2 In the **Settings** window for **Solution**, type Primary Current Distribution in the **Label** text field.

RESULTS

Polarization Plot

Now create a polarization plot for the primary current distribution model.

1 In the **Results** toolbar, click  **ID Plot Group**.

2 In the **Settings** window for **ID Plot Group**, type Polarization Plot in the **Label** text field.

3 Locate the **Data** section. From the **Dataset** list, choose **None**.

4 Click to expand the **Title** section. From the **Title type** list, choose **Label**.

5 Locate the **Plot Settings** section.

6 Select the **x-axis label** checkbox. In the associated text field, type Cell voltage (V).

- 7 Select the **y-axis label** checkbox. In the associated text field, type **Total current (A)**.
- 8 Locate the **Legend** section. From the **Position** list, choose **Upper left**.

Global 1

- 1 Right-click **Polarization Plot** and choose **Global**.
- 2 In the **Settings** window for **Global**, locate the **Data** section.
- 3 From the **Dataset** list, choose **Study 1/Primary Current Distribution (sol2)**.
- 4 Locate the **y-Axis Data** section. In the table, enter the following settings:

Expression	Unit	Description
<code>abs(anode_int(cd.nI1))</code>	A	

- 5 Click to expand the **Legends** section. From the **Legends** list, choose **Manual**.
- 6 In the table, enter the following settings:

Legends
Primary current distribution

- 7 In the **Polarization Plot** toolbar, click  **Plot**.

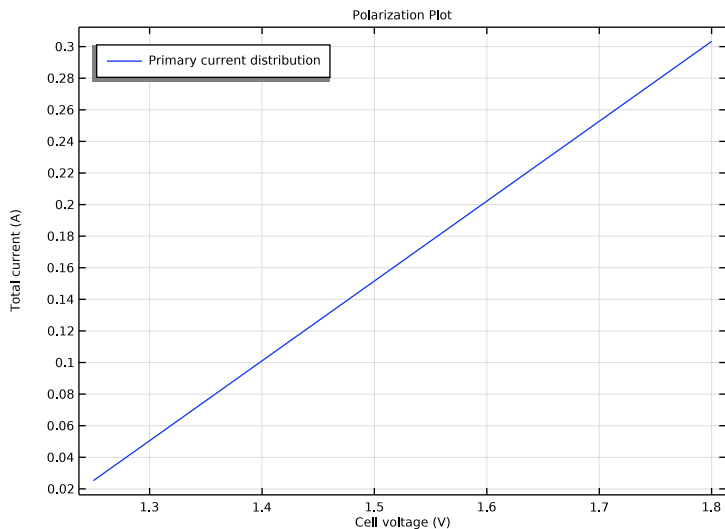

Electrolyte Potential

The following creates an isosurface of the potential in the electrolyte.

- 1 In the **Results** toolbar, click  **3D Plot Group**.

- 2 In the **Settings** window for **3D Plot Group**, type **Electrolyte Potential** in the **Label** text field.
- 3 Locate the **Data** section. From the **Dataset** list, choose **Study 1/ Primary Current Distribution (sol2)**.
- 4 From the **Parameter value (Ecell (V))** list, choose **1.45**.
- 5 Locate the **Plot Settings** section. Clear the **Plot dataset edges** checkbox.

Isosurface 1

- 1 Right-click **Electrolyte Potential** and choose **Isosurface**.
- 2 In the **Settings** window for **Isosurface**, locate the **Coloring and Style** section.
- 3 From the **Color table** list, choose **Bryophyta**.
- 4 In the **Electrolyte Potential** toolbar, click  **Plot**.

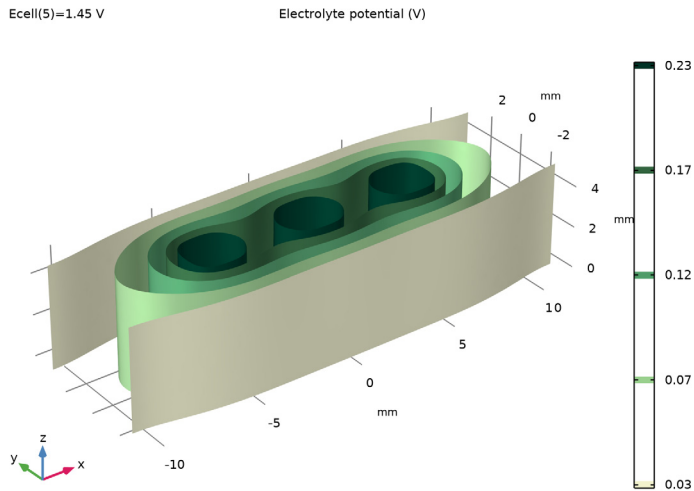

DEFINITIONS

The following creates a normalized plot of the normal electrolyte current density on the anode surface and one of the cathode surfaces. First, create a union selection for both anodes and cathodes.

Anodes and Cathodes

- 1 In the **Definitions** toolbar, click  **Union**.
- 2 In the **Settings** window for **Union**, locate the **Geometric Entity Level** section.

- 3 From the **Level** list, choose **Boundary**.
- 4 Locate the **Input Entities** section. Under **Selections to add**, click  **Add**.
- 5 In the **Add** dialog, in the **Selections to add** list, choose **Cathodes** and **Anode**.
- 6 Click **OK**.
- 7 In the **Settings** window for **Union**, type **Anodes** and **Cathodes** in the **Label** text field.
Before continuing to create the plot, hide the top and the front wall of the geometry

COMPONENT 1 (COMP1)

- 1 In the **Model Builder** window, click **Component 1 (comp1)**.
- 2 Click the  **Click and Hide** button in the **Graphics** toolbar.
- 3 Select **Boundary 4** only.
- 4 Select **Boundary 2** only.



RESULTS

Dimensionless Current Density Distribution

- 1 In the **Results** toolbar, click  **3D Plot Group**.
- 2 In the **Settings** window for **3D Plot Group**, type **Dimensionless Current Density Distribution** in the **Label** text field.
- 3 Locate the **Data** section. From the **Dataset** list, choose **Study 1/ Primary Current Distribution (sol2)**.
- 4 From the **Parameter value (Ecell (V))** list, choose **1.45**.
- 5 Click to expand the **Selection** section. From the **Geometric entity level** list, choose **Boundary**.
- 6 From the **Selection** list, choose **Anodes and Cathodes**.
- 7 Click to expand the **Title** section. From the **Title type** list, choose **Label**.
- 8 Locate the **Plot Settings** section. Clear the **Plot dataset edges** checkbox.

Surface 1

- 1 Right-click **Dimensionless Current Density Distribution** and choose **Surface**.
Plot the normal current density divided by the average normal current density.
- 2 In the **Settings** window for **Surface**, locate the **Expression** section.
- 3 In the **Expression** text field, type $(comp1.cd.nI1)/anode_avg(comp1.cd.nI1)$.
- 4 Click to expand the **Range** section. Select the **Manual color range** checkbox.
- 5 In the **Minimum** text field, type **-2**.

- 6 In the **Maximum** text field, type 2.
- 7 Locate the **Coloring and Style** section. From the **Color table** list, choose **Ctenophora**.
- 8 Click the  **Zoom Extents** button in the **Graphics** toolbar.
- 9 In the **Dimensionless Current Density Distribution** toolbar, click  **Plot**.

Ecell(5)=1.45 V

Dimensionless Current Density Distribution

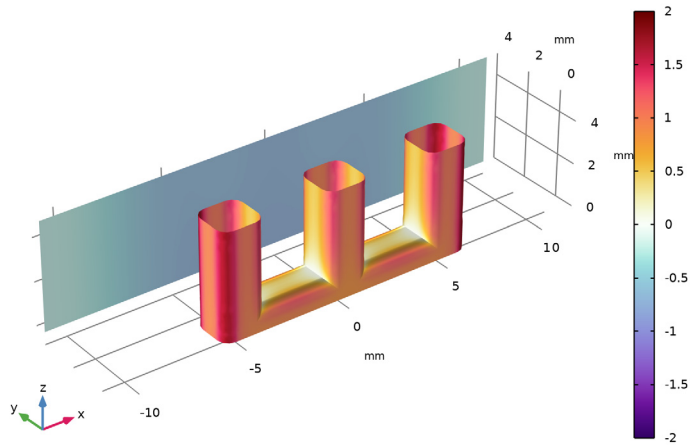

PRIMARY CURRENT DISTRIBUTION (CD)

Now modify the model to simulate the secondary current distribution.

- 1 In the **Model Builder** window, under **Component 1 (comp1)** click **Primary Current Distribution (cd)**.
- 2 In the **Settings** window for **Primary Current Distribution**, locate the **Current Distribution Type** section.
- 3 From the **Current distribution type** list, choose **Secondary**.

GLOBAL DEFINITIONS

Parameters 1

Add the needed parameters for the secondary model.

- 1 In the **Model Builder** window, under **Global Definitions** click **Parameters 1**.
- 2 In the **Settings** window for **Parameters**, locate the **Parameters** section.

3 In the table, enter the following settings:

Name	Expression	Value	Description
i0_c	100[A/m^2]	100 A/m ²	Cathode exchange current density
i0_a	100[A/m^2]	100 A/m ²	Anode exchange current density
be_c	0.5	0.5	Cathode symmetry factor
be_a	0.5	0.5	Anode symmetry factor
T	298[K]	298 K	Temperature

SECONDARY CURRENT DISTRIBUTION (CD)

Electrode Reaction 1

Now set up the new boundary conditions for the secondary current distribution by adding the needed kinetic parameters for **Electrode Reaction 1 (er1)** in **Electrode Surface 1 (es1)** node.

- 1 In the **Model Builder** window, under **Component 1 (comp1)** > **Secondary Current Distribution (cd)** > **Electrode Surface 1** click **Electrode Reaction 1**.
- 2 In the **Settings** window for **Electrode Reaction**, locate the **Electrode Kinetics** section.
- 3 From the **Kinetics expression type** list, choose **Butler–Volmer**.
- 4 In the i_0 text field, type i0_c.
- 5 In the α_a text field, type be_c.
- 6 In the α_c text field, type 1-be_c.

Similarly, define the kinetic parameters at the anode for **Electrode Reaction 1 (er1)** in **Electrode Surface 2 (es2)** node.

- 1 In the **Model Builder** window, under **Component 1 (comp1)** > **Secondary Current Distribution (cd)** > **Electrode Surface 2** click **Electrode Reaction 1**.
- 2 In the **Settings** window for **Electrode Reaction**, locate the **Electrode Kinetics** section.
- 3 From the **Kinetics expression type** list, choose **Butler–Volmer**.
- 4 In the i_0 text field, type i0_a.
- 5 In the α_a text field, type be_a.
- 6 In the α_c text field, type 1-be_a.

GLOBAL DEFINITIONS

Default Model Inputs

Set up the temperature value used in the entire model.

- 1 In the **Model Builder** window, under **Global Definitions** click **Default Model Inputs**.
- 2 In the **Settings** window for **Default Model Inputs**, locate the **Browse Model Inputs** section.
- 3 In the tree, select **General > Temperature (K) - minput.T**.
- 4 Find the **Expression for remaining selection** subsection. In the **Temperature** text field, type T.

STUDY I

In the **Study** toolbar, click  **Compute**.

RESULTS

Electrolyte Potential

You have now solved the secondary current distribution problem.

STUDY I

Secondary current distribution

- 1 In the **Model Builder** window, under **Study I > Solver Configurations** click **Solution I (sol1)**.
- 2 In the **Settings** window for **Solution**, type Secondary current distribution in the **Label** text field.

RESULTS

Proceed to look at the results by adding the secondary current distribution polarization plot.

Global 2

- 1 In the **Model Builder** window, under **Results > Polarization Plot** right-click **Global I** and choose **Duplicate**.
- 2 In the **Settings** window for **Global**, locate the **Data** section.
- 3 From the **Dataset** list, choose **Study I/Secondary current distribution (sol1)**.
- 4 Locate the **Legends** section. In the table, enter the following settings:

Legends
Secondary current distribution

Polarization Plot

- 1 In the **Model Builder** window, click **Polarization Plot**.
- 2 In the **Polarization Plot** toolbar, click  **Plot**.

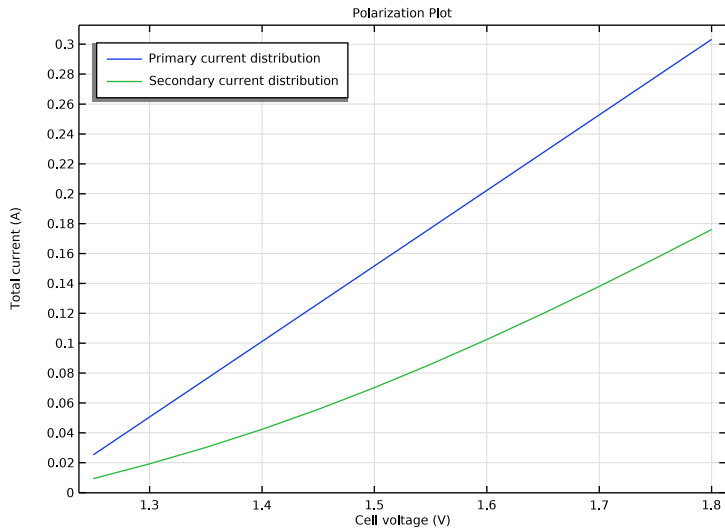

Electrolyte Potential

By choosing different datasets you may compare now the primary and secondary current distribution results in the 3D plots.

- 1 In the **Model Builder** window, click **Electrolyte Potential**.
- 2 In the **Settings** window for **3D Plot Group**, locate the **Data** section.
- 3 From the **Dataset** list, choose **Study 1/Secondary current distribution (sol1)**.
- 4 From the **Parameter value (Ecell (V))** list, choose **1.65**.
- 5 Click the  **Zoom Extents** button in the **Graphics** toolbar.

6 In the **Electrolyte Potential** toolbar, click  **Plot**.

Ecell(9)=1.65 V

Electrolyte potential (V)

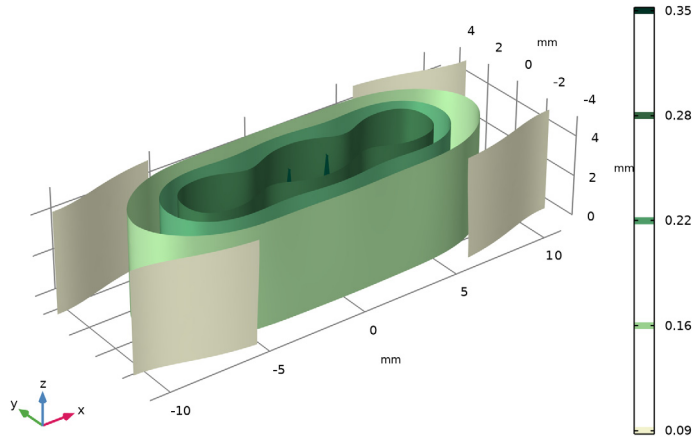

Dimensionless Current Density Distribution

- 1 In the **Model Builder** window, click **Dimensionless Current Density Distribution**.
- 2 In the **Settings** window for **3D Plot Group**, locate the **Data** section.
- 3 From the **Dataset** list, choose **Study 1/Secondary current distribution (sol1)**.
- 4 From the **Parameter value (Ecell (V))** list, choose **1.65**.
- 5 Click the  **Zoom Extents** button in the **Graphics** toolbar.

6 In the **Dimensionless Current Density Distribution** toolbar, click  **Plot**.

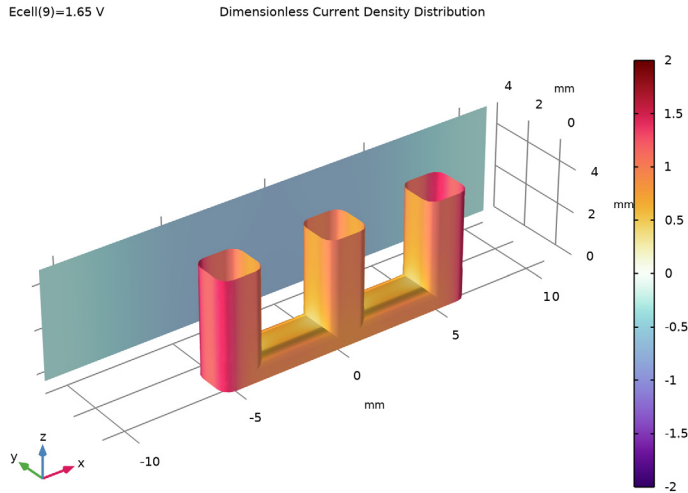

GLOBAL DEFINITIONS

Now modify the problem to model a tertiary current distribution problem by adding mass transport. Start by adding the parameters.

Parameters 1

- 1 In the **Model Builder** window, under **Global Definitions** click **Parameters 1**.
- 2 In the **Settings** window for **Parameters**, locate the **Parameters** section.
- 3 In the table, enter the following settings:

Name	Expression	Value	Description
D	1e-9[m ² /s]	1E-9 m ² /s	Diffusion coefficient
c_in	1e3[mol/m ³]	1000 mol/m ³	Inlet concentration
u_in	5[mm/s]	0.005 m/s	Inlet flow velocity

ADD PHYSICS

- 1 In the **Home** toolbar, click  **Add Physics** to open the **Add Physics** window.
- 2 Go to the **Add Physics** window.
- 3 In the tree, select **Chemical Species Transport** > **Transport of Diluted Species (tds)**.
- 4 Click the **Add to Component 1** button in the window toolbar.

- 5 In the tree, select **Fluid Flow > Single-Phase Flow > Laminar Flow (spf)**.
- 6 Click the **Add to Component I** button in the window toolbar.
- 7 In the **Home** toolbar, click  **Add Physics** to close the **Add Physics** window.

TRANSPORT OF DILUTED SPECIES (TDS)

- 1 In the **Settings** window for **Transport of Diluted Species**, locate the **Transport Mechanisms** section.
- 2 Select the **Migration in electric field** checkbox.

Species Charges

- 1 In the **Model Builder** window, under **Component I (comp1) > Transport of Diluted Species (tds)** click **Species Charges**.
- 2 In the **Settings** window for **Species Properties**, locate the **Charge** section.
- 3 In the z_c text field, type -1.



Fluid I

The velocity field will be coupled to Laminar Flow later using the Reacting Flow multiphysics feature.

- 1 In the **Model Builder** window, click **Fluid I**.
- 2 In the **Settings** window for **Fluid**, locate the **Diffusion** section.
- 3 In the D_c text field, type D.

The migration potential will be coupled to Secondary Current Distribution later using the Potential Coupling multiphysics feature.

Inflow I

- 1 In the **Physics** toolbar, click  **Boundaries** and choose **Inflow**.
- 2 Select Boundary 1 only.
- 3 In the **Settings** window for **Inflow**, locate the **Boundary Selection** section.
- 4 Click  **Create Selection**.
- 5 In the **Create Selection** dialog, type Inlet in the **Selection name** text field.
- 6 Click **OK**.
- 7 In the **Settings** window for **Inflow**, locate the **Concentration** section.
- 8 In the $c_{0,c}$ text field, type c_{in} .

Outflow I

- 1 In the **Physics** toolbar, click  **Boundaries** and choose **Outflow**.

- 2 Select Boundary 52 only.
- 3 In the **Settings** window for **Outflow**, locate the **Boundary Selection** section.
- 4 Click  **Create Selection**.
- 5 In the **Create Selection** dialog, type Outlet in the **Selection name** text field.
- 6 Click **OK**.

Initial Values 1

- 1 In the **Model Builder** window, click **Initial Values 1**.
- 2 In the **Settings** window for **Initial Values**, locate the **Initial Values** section.
- 3 In the c text field, type c_{in} .

Electrode Surface Coupling 1

Couple the flux on the anode surface to the electrode reaction currents by using an Electrode-Electrolyte Interface Coupling feature.

- 1 In the **Physics** toolbar, click  **Boundaries** and choose **Electrode Surface Coupling**.
- 2 In the **Settings** window for **Electrode Surface Coupling**, locate the **Boundary Selection** section.
- 3 From the **Selection** list, choose **Anode**.

Reaction Coefficients 1

- 1 In the **Model Builder** window, expand the **Electrode Surface Coupling 1** node, then click **Reaction Coefficients 1**.
- 2 In the **Settings** window for **Reaction Coefficients**, locate the **Reaction Current Density** section.
- 3 From the i_{loc} list, choose **Local current density, Electrode Reaction 1 (cd/es2/er1)**.
- 4 Locate the **Stoichiometric Coefficients** section. In the ν_c text field, type 1.

SECONDARY CURRENT DISTRIBUTION (CD)

Also modify the current density expression to be concentration dependent.

Electrode Reaction 1

- 1 In the **Model Builder** window, under **Component 1 (comp1) > Secondary Current Distribution (cd) > Electrode Surface 2** click **Electrode Reaction 1**.
- 2 In the **Settings** window for **Electrode Reaction**, locate the **Equilibrium Potential** section.
- 3 From the E_{eq} list, choose **Nernst equation**.
- 4 In the $E_{eq,ref}(T)$ text field, type E_{eq_a} .

- 5 In the C_R text field, type c/c_{in} .
- 6 Locate the **Electrode Kinetics** section. From the **Exchange current density type** list, choose **From Nernst Equation**.
- 7 In the $i_{0,ref}(T)$ text field, type $i0_a$.

LAMINAR FLOW (SPF)

In the **Model Builder** window, under **Component 1 (comp1)** click **Laminar Flow (spf)**.

Inlet 1

- 1 In the **Physics** toolbar, click  **Boundaries** and choose **Inlet**.
- 2 In the **Settings** window for **Inlet**, locate the **Boundary Selection** section.
- 3 From the **Selection** list, choose **Inlet**.
- 4 Locate the **Boundary Condition** section. From the list, choose **Fully developed flow**.
- 5 Locate the **Fully Developed Flow** section. In the U_{av} text field, type u_{in} .

Outlet 1

- 1 In the **Physics** toolbar, click  **Boundaries** and choose **Outlet**.
- 2 In the **Settings** window for **Outlet**, locate the **Boundary Selection** section.
- 3 From the **Selection** list, choose **Outlet**.
- 4 Locate the **Pressure Conditions** section. Select the **Normal flow** checkbox.

Wall 2

- 1 In the **Physics** toolbar, click  **Boundaries** and choose **Wall**.
- 2 Select Boundaries 3 and 4 only.
- 3 In the **Settings** window for **Wall**, locate the **Boundary Condition** section.
- 4 From the **Wall condition** list, choose **Slip**.

MULTIPHYSICS

Finally, set up the Reacting Flow and Potential Coupling multiphysics features.

Reacting Flow, Diluted Species 1 (rfd1)

In the **Physics** toolbar, click  **Multiphysics Couplings** and choose **Domain > Reacting Flow, Diluted Species**.



Potential Coupling 1 (pc1)

- 1 In the **Physics** toolbar, click  **Multiphysics Couplings** and choose **Domain > Potential Coupling**.
- 2 Select Domain 1 only.

ROOT

Next, set up the solver for the tertiary current distribution problem. Do this by adding a new study wherein you first solve for the flow problem, which does not depend on the other variables, and then the species transport and electric currents.

ADD STUDY



- 1 In the **Home** toolbar, click  **Add Study** to open the **Add Study** window.
- 2 Go to the **Add Study** window.
- 3 Find the **Studies** subsection. In the **Select Study** tree, select **General Studies > Stationary**.
- 4 Click the **Add Study** button in the window toolbar.
- 5 In the **Home** toolbar, click  **Add Study** to close the **Add Study** window.

STUDY 2

Step 1: Stationary

- 1 In the **Settings** window for **Stationary**, locate the **Physics and Variables Selection** section.
- 2 In the **Solve for** column of the table, under **Component 1 (comp1)**, clear the checkboxes for **Secondary Current Distribution (cd)** and **Transport of Diluted Species (tds)**.

Step 2: Stationary 2

- 1 In the **Study** toolbar, click  **Stationary**.
- 2 In the **Settings** window for **Stationary**, locate the **Physics and Variables Selection** section.
- 3 In the **Solve for** column of the table, under **Component 1 (comp1)**, clear the checkbox for **Laminar Flow (spf)**.
Set up an auxiliary continuation sweep for the Ecell parameter.
- 4 Click to expand the **Study Extensions** section. Select the **Auxiliary sweep** checkbox.
- 5 Click  **Add**.
- 6 In the table, enter the following settings:

Parameter name	Parameter value list	Parameter unit
Ecell (Cell voltage)	range (1.25, 0.05, 1.8)	V

Solution 3 (sol3)

Change to a fully coupled direct solver to decrease solver time.

- 1 In the **Study** toolbar, click  **Show Default Solver**.
- 2 In the **Model Builder** window, expand the **Solution 3 (sol3)** node.

- 3 Right-click **Study 2 > Solver Configurations > Solution 3 (sol3) > Stationary Solver 2** and choose **Fully Coupled**.
- 4 In the **Settings** window for **Fully Coupled**, locate the **General** section.
- 5 From the **Linear solver** list, choose **Direct (cd)**.
- 6 In the **Model Builder** window, click **Study 2**.
- 7 In the **Settings** window for **Study**, type Tertiary Current Distribution in the **Label** text field.
- 8 Locate the **Study Settings** section. Clear the **Generate default plots** checkbox.
- 9 In the **Study** toolbar, click  **Compute**.

You have now solved the tertiary current distribution.

RESULTS

Add the tertiary current distribution to the polarization plot.

Global 3

- 1 In the **Model Builder** window, under **Results > Polarization Plot** right-click **Global 2** and choose **Duplicate**.
- 2 In the **Settings** window for **Global**, locate the **Data** section.
- 3 From the **Dataset** list, choose **Tertiary Current Distribution/Solution 3 (sol3)**.
- 4 Locate the **Legends** section. In the table, enter the following settings:

Legends
Tertiary current distribution

5 In the **Polarization Plot** toolbar, click  **Plot**.

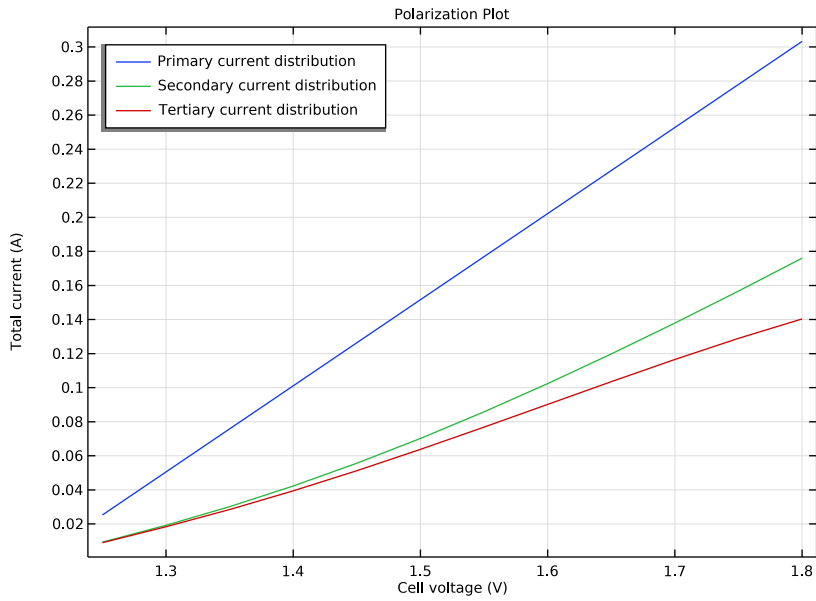

Electrolyte Potential

- 1 In the **Model Builder** window, under **Results** click **Electrolyte Potential**.
- 2 In the **Settings** window for **3D Plot Group**, locate the **Data** section.
- 3 From the **Dataset** list, choose **Tertiary Current Distribution/Solution 3 (sol3)**.

4 In the **Electrolyte Potential** toolbar, click  **Plot**.

Ecell(9)=1.65 V

Electrolyte potential (V)

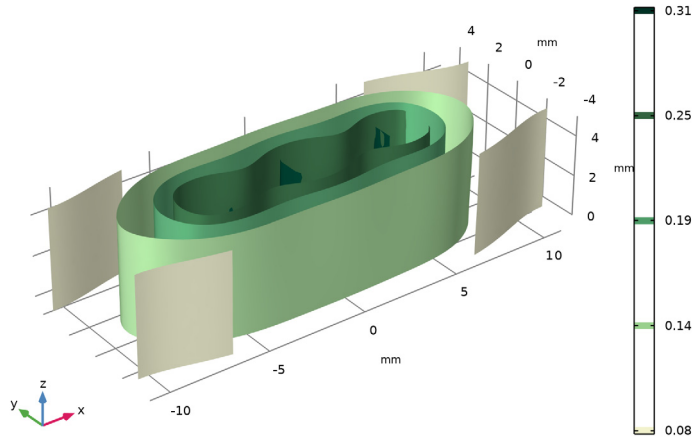

Dimensionless Current Density Distribution

- 1 In the **Model Builder** window, click **Dimensionless Current Density Distribution**.
- 2 In the **Settings** window for **3D Plot Group**, locate the **Data** section.
- 3 From the **Dataset** list, choose **Tertiary Current Distribution/Solution 3 (sol3)**.
- 4 Click the  **Zoom Extents** button in the **Graphics** toolbar.

- 5 In the **Dimensionless Current Density Distribution** toolbar, click  **Plot**.

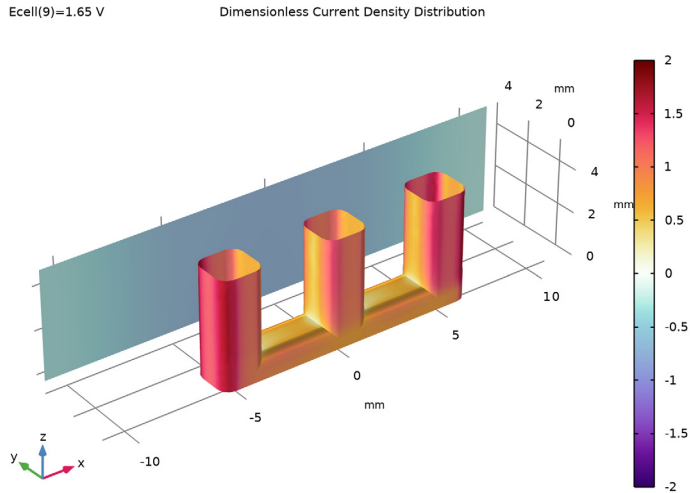

Velocity

- 1 In the **Results** toolbar, click  **3D Plot Group**.
- 2 In the **Settings** window for **3D Plot Group**, type **Velocity** in the **Label** text field.
- 3 Locate the **Data** section. From the **Dataset** list, choose **Tertiary Current Distribution/ Solution 3 (sol3)**.

Slice 1

- 1 Right-click **Velocity** and choose **Slice**.
- 2 In the **Settings** window for **Slice**, click **Replace Expression** in the upper-right corner of the **Expression** section. From the menu, choose **Component 1 (comp1) > Laminar Flow > Velocity and pressure > spf.U - Velocity magnitude - m/s**.
- 3 Locate the **Plane Data** section. In the **Planes** text field, type **7**.
- 4 Locate the **Coloring and Style** section. From the **Color table** list, choose **Metasepia**.
- 5 From the **Color table transformation** list, choose **Reverse**.
- 6 Click the  **Zoom Extents** button in the **Graphics** toolbar.

7 In the **Velocity** toolbar, click  **Plot**.

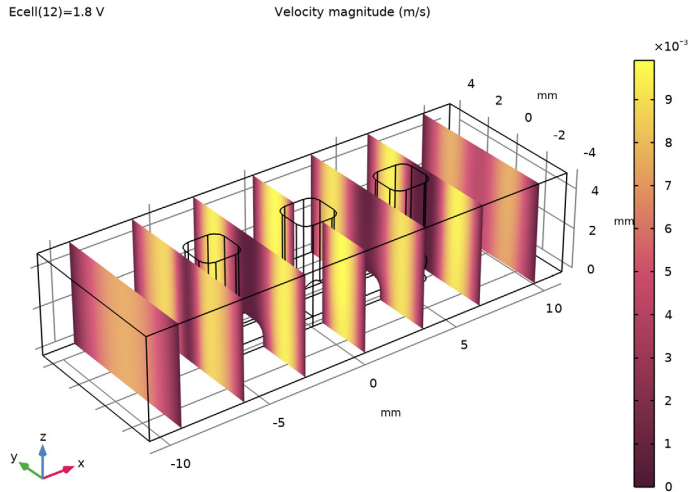

Concentration

Finish the postprocessing by creating an arrow, slice, and surface plot that visualizes the concentration and flow in the cell.

- 1 In the **Results** toolbar, click  **3D Plot Group**.
- 2 In the **Settings** window for **3D Plot Group**, type **Concentration** in the **Label** text field.
- 3 Locate the **Data** section. From the **Dataset** list, choose **Tertiary Current Distribution/ Solution 3 (sol3)**.
- 4 Click to expand the **Title** section. From the **Title type** list, choose **Label**.
- 5 Locate the **Plot Settings** section. Clear the **Plot dataset edges** checkbox.
- 6 Locate the **Color Legend** section. Select the **Show units** checkbox.

Arrow Volume I

- 1 Right-click **Concentration** and choose **Arrow Volume**.
- 2 In the **Settings** window for **Arrow Volume**, click **Replace Expression** in the upper-right corner of the **Expression** section. From the menu, choose **Component 1 (comp1) > Laminar Flow > Velocity and pressure > u,v,w - Velocity field**.
- 3 Locate the **Arrow Positioning** section. Find the **x grid points** subsection. In the **Points** text field, type 10.
- 4 Find the **y grid points** subsection. In the **Points** text field, type 10.

- 5 Find the **z grid points** subsection. In the **Points** text field, type 1.
- 6 Locate the **Coloring and Style** section. From the **Color** list, choose **White**.

Arrow Volume 2

- 1 Right-click **Arrow Volume 1** and choose **Duplicate**.
- 2 In the **Settings** window for **Arrow Volume**, click to expand the **Title** section.
- 3 From the **Title type** list, choose **None**.
- 4 Locate the **Arrow Positioning** section. Find the **y grid points** subsection. In the **Points** text field, type 1.
- 5 Find the **z grid points** subsection. In the **Points** text field, type 10.
- 6 Click to expand the **Inherit Style** section. From the **Plot** list, choose **Arrow Volume 1**.
- 7 In the **Concentration** toolbar, click  **Plot**.

Concentration

In the **Model Builder** window, click **Concentration**.

Multislice 1

- 1 In the **Concentration** toolbar, click  **More Plots** and choose **Multislice**.
- 2 In the **Settings** window for **Multislice**, click **Replace Expression** in the upper-right corner of the **Expression** section. From the menu, choose **Component 1 (comp1) > Transport of Diluted Species > Species c > c - Molar concentration, c - mol/m³**.
- 3 Locate the **Multiphase Data** section. Find the **x-planes** subsection. In the **Planes** text field, type 0.
- 4 Locate the **Coloring and Style** section. From the **Color table** list, choose **Pelagic**.

Visual Effects 1

- 1 Right-click **Multislice 1** and choose **Visual Effects**.
- 2 In the **Settings** window for **Visual Effects**, locate the **Visual Effects** section.
- 3 Clear the **Affected by lighting** checkbox.

Transparency 1

- 1 In the **Model Builder** window, right-click **Multislice 1** and choose **Transparency**.
- 2 In the **Settings** window for **Transparency**, locate the **Transparency** section.
- 3 Find the **Transparency** subsection. In the **Transparency** text field, type 0.2.

Anode

- 1 In the **Model Builder** window, right-click **Concentration** and choose **Surface**.
- 2 In the **Settings** window for **Surface**, type Anode in the **Label** text field.

- 3 Click **Replace Expression** in the upper-right corner of the **Expression** section. From the menu, choose **Component 1 (comp1) > Transport of Diluted Species > Species c > c - Molar concentration, c - mol/m³**.
- 4 Click to expand the **Inherit Style** section. From the **Plot** list, choose **Multislice I**.

Selection 1

- 1 Right-click **Anode** and choose **Selection**.
- 2 In the **Settings** window for **Selection**, locate the **Selection** section.
- 3 From the **Selection** list, choose **Anode**.

Cathode

- 1 In the **Model Builder** window, right-click **Concentration** and choose **Surface**.
- 2 In the **Settings** window for **Surface**, type Cathode in the **Label** text field.
- 3 Click **Replace Expression** in the upper-right corner of the **Expression** section. From the menu, choose **Component 1 (comp1) > Transport of Diluted Species > Species c > c - Molar concentration, c - mol/m³**.
- 4 Click to expand the **Inherit Style** section. From the **Plot** list, choose **Multislice I**.

Selection 1

- 1 Right-click **Cathode** and choose **Selection**.
- 2 Select Boundary 5 only.
- 3 In the **Concentration** toolbar, click  **Plot**.

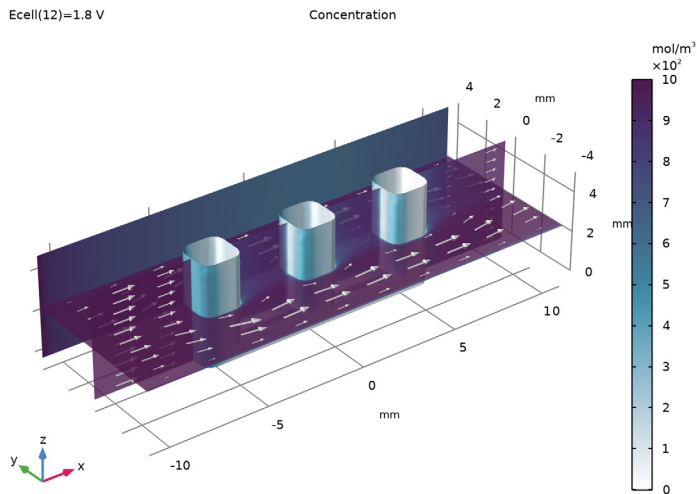

From the **File** menu, choose **New**.

NEW

In the **New** window, click  **Blank Model**.

ADD COMPONENT

In the **Home** toolbar, click  **Add Component** and choose **3D**.

GEOMETRY I

1 In the **Settings** window for **Geometry**, locate the **Units** section.

2 From the **Length unit** list, choose **mm**.

Block 1 (blk1)

In the **Geometry** toolbar, click  **Block**.

DEFINITIONS

View 1

1 In the **Model Builder** window, expand the **Component 1 (comp1) > Definitions** node, then click **View 1**.

2 In the **Settings** window for **View**, locate the **View** section.

3 Select the **Wireframe rendering** checkbox.

GEOMETRY I

Block 1 (blk1)

1 In the **Model Builder** window, under **Component 1 (comp1) > Geometry 1** click **Block 1 (blk1)**.

2 In the **Settings** window for **Block**, locate the **Size and Shape** section.

3 In the **Width** text field, type 22.

4 In the **Depth** text field, type 8.

5 In the **Height** text field, type 5.

6 Locate the **Position** section. In the **x** text field, type -11.

7 In the **y** text field, type -4.

Cumulative Selections

In the **Geometry** toolbar, click  **Selections** and choose **Cumulative Selections**.

Union

- 1 Right-click **Cumulative Selections** and choose **Cumulative Selection**.
- 2 In the **Settings** window for **Selection**, type Union in the **Label** text field.

Work Plane 1 (wp1)

- 1 In the **Geometry** toolbar, click  **Work Plane**.
- 2 In the **Settings** window for **Work Plane**, locate the **Plane Definition** section.
- 3 In the **z-coordinate** text field, type -1.

Work Plane 1 (wp1) > Plane Geometry

In the **Model Builder** window, click **Plane Geometry**.

Work Plane 1 (wp1) > Square 1 (sq1)

- 1 In the **Work Plane** toolbar, click  **Square**.
- 2 In the **Settings** window for **Square**, locate the **Size** section.
- 3 In the **Side length** text field, type 2.
- 4 Locate the **Position** section. In the **xw** text field, type -6.
- 5 In the **yw** text field, type -1.
- 6 Locate the **Selections of Resulting Entities** section. Select the **Resulting objects selection** checkbox.

Work Plane 1 (wp1) > Fillet 1 (fil1)

- 1 In the **Work Plane** toolbar, click  **Fillet**.
- 2 On the object **sq1**, select Points 1–4 only.
- 3 In the **Settings** window for **Fillet**, locate the **Radius** section.
- 4 In the **Radius** text field, type 0.5.
- 5 Locate the **Selections of Resulting Entities** section. Select the **Resulting objects selection** checkbox.

Work Plane 1 (wp1) > Array 1 (arr1)

- 1 In the **Work Plane** toolbar, click  **Transforms** and choose **Array**.
- 2 Select the object **fil1** only.
- 3 In the **Settings** window for **Array**, locate the **Size** section.
- 4 In the **xw size** text field, type 3.
- 5 Locate the **Displacement** section. In the **xw** text field, type 5.

Extrude 1 (ext1)

- 1 In the **Model Builder** window, right-click **Geometry 1** and choose **Extrude**.
- 2 In the **Settings** window for **Extrude**, locate the **Distances** section.
- 3 In the table, enter the following settings:

Distances (mm)
6

- 4 Locate the **Selections of Resulting Entities** section. Find the **Cumulative selection** subsection. From the **Contribute to** list, choose **Union**.

Work Plane 2 (wp2)

- 1 In the **Geometry** toolbar, click  **Work Plane**.
- 2 In the **Settings** window for **Work Plane**, locate the **Plane Definition** section.
- 3 From the **Plane** list, choose **yz-plane**.
- 4 In the **x-coordinate** text field, type 11.

Work Plane 2 (wp2) > Plane Geometry

In the **Model Builder** window, click **Plane Geometry**.

Work Plane 2 (wp2) > Square 1 (sq1)

- 1 In the **Work Plane** toolbar, click  **Square**.
- 2 In the **Settings** window for **Square**, locate the **Size** section.
- 3 In the **Side length** text field, type 2.
- 4 Locate the **Position** section. From the **Base** list, choose **Center**.
- 5 Locate the **Selections of Resulting Entities** section. Select the **Resulting objects selection** checkbox.

Work Plane 2 (wp2) > Fillet 1 (fil1)

- 1 In the **Work Plane** toolbar, click  **Fillet**.
- 2 On the object **sq1**, select Points 1–4 only.
- 3 In the **Settings** window for **Fillet**, locate the **Radius** section.
- 4 In the **Radius** text field, type 0.5.

Extrude 2 (ext2)

- 1 In the **Model Builder** window, right-click **Geometry 1** and choose **Extrude**.
- 2 In the **Settings** window for **Extrude**, locate the **Distances** section.

3 In the table, enter the following settings:

Distances (mm)
22

4 Select the **Reverse direction** checkbox.

5 Locate the **Selections of Resulting Entities** section. Find the **Cumulative selection** subsection. From the **Contribute to** list, choose **Union**.

Union 1 (un1)

1 In the **Geometry** toolbar, click  **Booleans and Partitions** and choose **Union**.

2 In the **Settings** window for **Union**, locate the **Union** section.

3 From the **Input objects** list, choose **Union**.

4 Click  **Build Selected**.

Delete Entities 1 (dell)

1 Right-click **Geometry 1** and choose **Delete Entities**.

2 In the **Settings** window for **Delete Entities**, locate the **Entities or Objects to Delete** section.

3 From the **Geometric entity level** list, choose **Domain**.

4 Click the  **Zoom Extents** button in the **Graphics** toolbar.

5 On the object **un1**, select Domains 1 and 16 only.

- 6 Locate the **Selections of Resulting Entities** section. Select the **Resulting objects selection** checkbox.

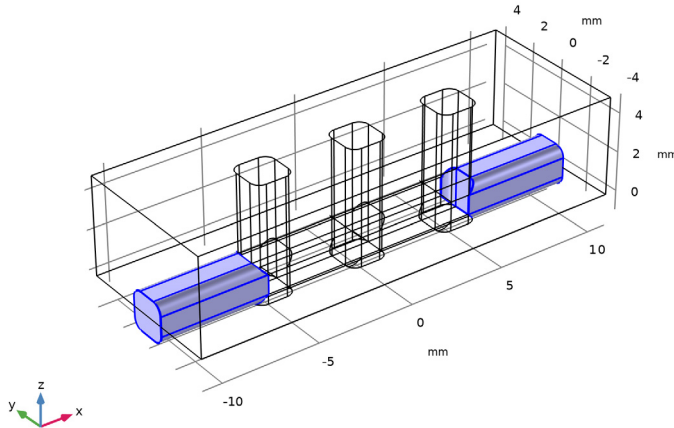

Union 2 (uni2)

- 1 In the **Geometry** toolbar, click  **Booleans and Partitions** and choose **Union**.
- 2 In the **Settings** window for **Union**, locate the **Union** section.
- 3 From the **Input objects** list, choose **Delete Entities 1**.
- 4 Locate the **Selections of Resulting Entities** section. Select the **Resulting objects selection** checkbox.

Difference 1 (dif1)



- 1 In the **Geometry** toolbar, click  **Booleans and Partitions** and choose **Difference**.
- 2 Select the object **blk1** only.
- 3 In the **Settings** window for **Difference**, locate the **Difference** section.
- 4 From the **Objects to subtract** list, choose **Union 2**.

Anode

- 1 In the **Geometry** toolbar, click  **Selections** and choose **Box Selection**.
- 2 In the **Settings** window for **Box Selection**, locate the **Geometric Entity Level** section.
- 3 From the **Level** list, choose **Boundary**.
- 4 Locate the **Box Limits** section. In the **x minimum** text field, type -60.

- 5 In the **x maximum** text field, type 60.
- 6 In the **y minimum** text field, type -2.
- 7 In the **y maximum** text field, type 2.
- 8 In the **Model Builder** window, click **Box Selection I (boxsell)**.
- 9 In the **Label** text field, type Anode.
- 10 Locate the **Output Entities** section. From the **Include entity if** list, choose **Entity inside box**.

Cathodes

- 1 In the **Geometry** toolbar, click  **Selections** and choose **Explicit Selection**.
- 2 In the **Settings** window for **Explicit Selection**, type Cathodes in the **Label** text field.
- 3 Locate the **Entities to Select** section. From the **Geometric entity level** list, choose **Boundary**.
- 4 Click in the **Graphics** window and then press Ctrl+D to clear all objects.
- 5 Click to select the  **Activate Selection** toggle button for **Entities to select**.
- 6 On the object **dif1**, select Boundaries 2 and 5 only.



Anode (boxsell), Cathodes (sell)

- 1 In the **Model Builder** window, under **Component 1 (comp1) > Geometry 1**, Ctrl-click to select **Anode (boxsell)** and **Cathodes (sell)**.
- 2 Right-click and choose **Move Down**.

Inlet

- 1 In the **Geometry** toolbar, click  **Selections** and choose **Explicit Selection**.
- 2 In the **Settings** window for **Explicit Selection**, type Inlet in the **Label** text field.
- 3 Locate the **Entities to Select** section. From the **Geometric entity level** list, choose **Boundary**.
- 4 On the object **fin**, select Boundary 1 only.

Outlet

- 1 In the **Geometry** toolbar, click  **Selections** and choose **Explicit Selection**.
- 2 In the **Settings** window for **Explicit Selection**, type Outlet in the **Label** text field.
- 3 Locate the **Entities to Select** section. From the **Geometric entity level** list, choose **Boundary**.
- 4 On the object **fin**, select Boundary 52 only.
- 5 In the **Geometry** toolbar, click  **Build All**.

