



Model created in COMSOL Multiphysics 6.4

# Bracket – Fatigue Evaluation

## Introduction

---

The S-N curve, also called the Wöhler curve, is one of the most popular methods for fatigue evaluation. The curve relates the stress amplitude to the limiting fatigue life and can be obtained directly from a set of standard fatigue test. Often, a structure is however subjected to conditions different from the experimental conditions of the fatigue tests. The fatigue data must then be appropriately modified in order to take the actual operating conditions into account.

In this example it is shown how to perform a fatigue evaluation when the material data needs to account for harsh environmental conditions and poor manufacturing process.

## Model Definition

---

The bracket geometry can be seen in [Figure 1](#). The component is subjected to external loads that lift one arm up and pull the other arm down. The load magnitude is cycled between a zero load, a peak load and back to zero load. Additional information regarding the model set up can be found in the documentation of the application *Bracket-Spring Foundation Analysis*, found in the Structural Mechanics Module.

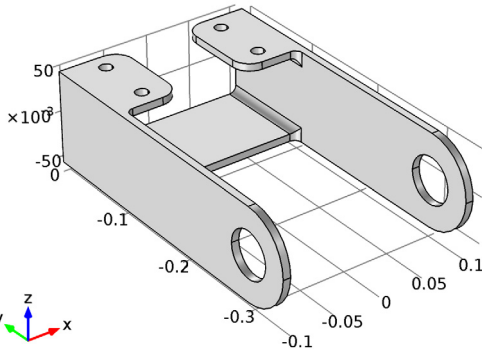

*Figure 1: Bracket geometry.*

The structural steel in the bracket has poor cleanliness and contains fairly large inclusions. It is well known that with decreasing purity the endurance limit decreases and thus large inclusions shorten the lifetime. The fatigue properties of the material have been tested in a material laboratory and are summarized in [Table 1](#). The material has a distinct endurance

limit at 110 MPa. Tests were performed in nominal testing conditions and on specimens with a very good surface finish.

TABLE I: S-N CURVE DATA.

<b>Fatigue lifetime (cycles)</b>	<b>Stress amplitude (MPa)</b>
1.10e3	360
2.17e3	320
3.82e3	290
7.15e3	260
1.45e4	230
3.23e4	200
5.92e4	180
1.16e5	160
2.51e5	140
6.09e5	120
1.00e6	110

As opposed to the testing conditions, the bracket was machined and has a rough surface as a result. Moreover the bracket operates in salt water that has a strong influence on the fatigue resistance. Since there is lack of test data for the operating conditions, the S-N curve data must be modified. One approach is to use

$$\sigma_a = k \cdot f_{SN}(N) \quad (1)$$

where  $\sigma_a$  is the stress amplitude,  $k$  is the modification factor,  $N$  is the fatigue lifetime, and  $f_{SN}$  is the S-N curve. Based on experience, the modification factor for the corrosion in salt water can be set to 0.4. The modification factor for the surface finish, due to machining manufacturing technique, can be set to 0.7. The modification factor in [Equation 1](#) for the combined effect is simply the product of the modification factors for all operating conditions and thus 0.28.

## Results and Discussion

The stress distribution in the bracket at the peak load is shown in [Figure 2](#).

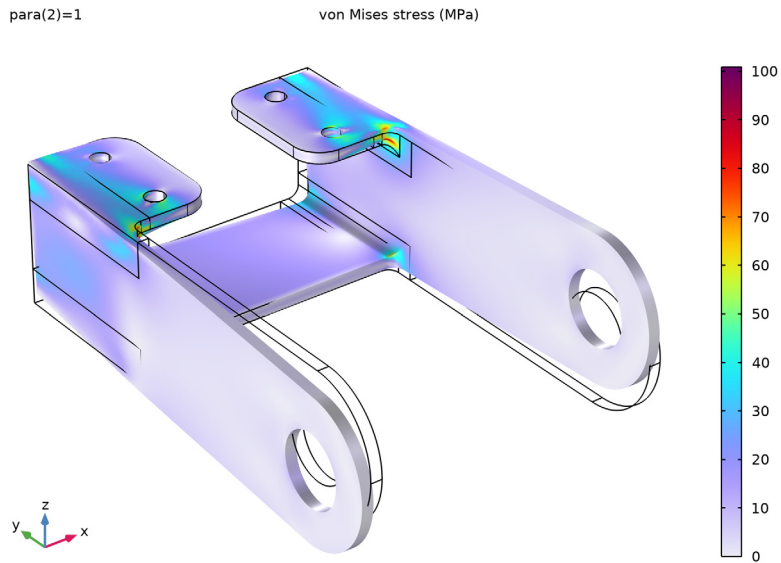

*Figure 2: Stress in the bracket at the peak operating load.*

A close-up of the part with stress concentrations reveals that stresses are significant also on the inner side of the bracket, see [Figure 3](#).

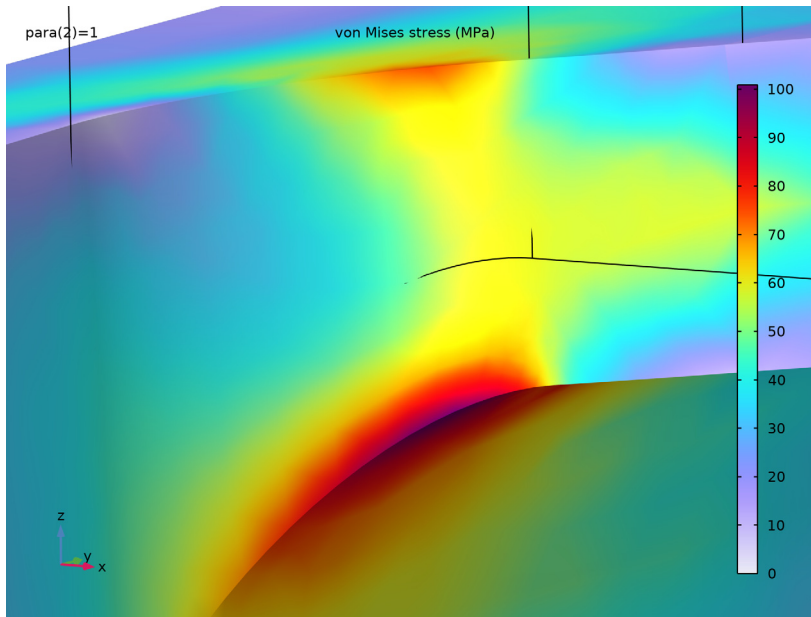

*Figure 3: A close-up of the part of the bracket that experiences the highest stresses.*

The fatigue analysis of the bracket material, modified for the manufacturing conditions predicts infinite life. When submerged in saltwater, the stresses in most of the bracket are not high enough to cause fatigue. Only in a few local points is there is a risk of fatigue, see

Figure 4. The bracket most probably fails in the connection between the two flat parts since the stresses on both the upper and the lower sides are high enough to initiate fatigue.

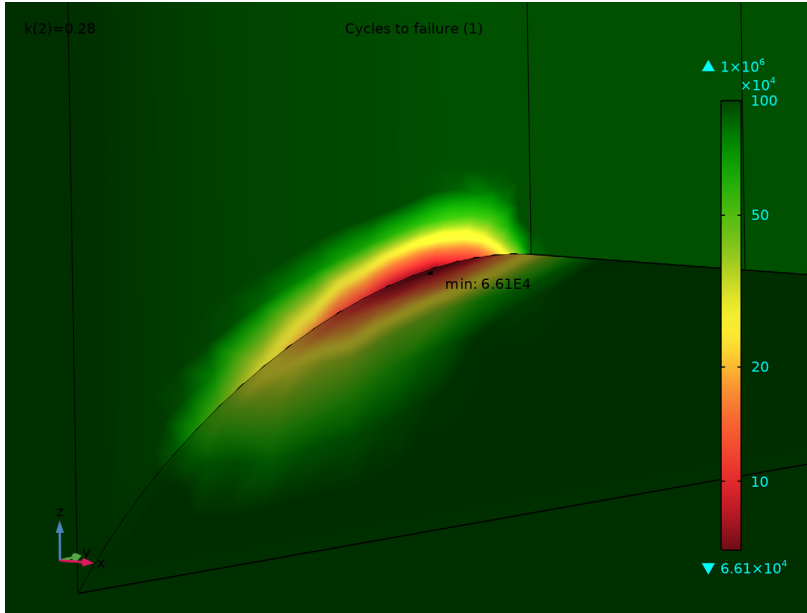

Figure 4: Fatigue lifetime when bracket is submerged in salt water.

In Figure 4 a finite life is predicted close to the holes that fasten the bracket. Those results are highly dependent on the boundary conditions that were applied there. In this model a spring foundation was used to fasten the bracket, but the constraint could have also been applied using a fixed connection or with a full contact analysis. This would change the stress field in the vicinity of the holes and result in a different fatigue lifetime.

### Notes About the COMSOL Implementation

The S-N curve can be defined using different function types in COMSOL Multiphysics. When using an interpolation function it is important to use many points to specify the relation between fatigue life and stress amplitude, since the range of the fatigue life is very large and a small change in the stress amplitude results in a large change in the fatigue life. The function value between two data points can be evaluated in different ways but linear interpolation is the most common one. In Figure 5 the S-N curve is specified with eleven and with four measurement points respectively. Note that the fatigue life is displayed in a logarithmic scale and therefore the interpolation is not a straight line. The two curves

display large differences. At 200 MPa one curve predicts  $3.23 \cdot 10^4$  cycles while the other predicts  $5.80 \cdot 10^4$  cycles; a difference by almost a factor two.

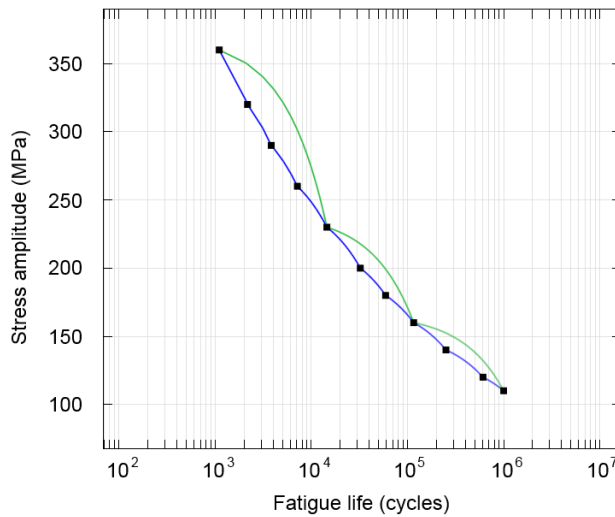

Figure 5: S-N curve based different number of measurement points.

---

**Application Library path:** Fatigue\_Module/Stress\_Life/bracket\_fatigue

---

### *Modeling Instructions*

---

#### **ROOT**

In this example you will start from an existing model from the Structural Mechanics Module.

#### **APPLICATION LIBRARIES**

- 1 From the **File** menu, choose **Application Libraries**.
- 2 In the **Application Libraries** window, select **Structural Mechanics Module > Tutorials > bracket\_spring** in the tree.
- 3 Click  **Open**.

## ROOT

Fatigue is calculated based on a load cycle. Create a parameter to scale the magnitude of the external load.

## GLOBAL DEFINITIONS

### Parameters 1

- 1 In the **Model Builder** window, under **Global Definitions** click **Parameters 1**.
- 2 In the **Settings** window for **Parameters**, locate the **Parameters** section.
- 3 In the table, enter the following settings:

Name	Expression	Value	Description
para	0	0	Load cycle control
k	1.0	1	Stress factor

## COMPONENT 1 (COMP1)

In the **Model Builder** window, expand the **Component 1 (comp1)** node.

## SOLID MECHANICS (SOLID)

### Boundary Load 1

- 1 In the **Model Builder** window, expand the **Component 1 (comp1) > Solid Mechanics (solid)** node, then click **Boundary Load 1**.
- 2 In the **Settings** window for **Boundary Load**, locate the **Force** section.
- 3 Specify the  $\mathbf{f}_A$  vector as

$p0 * \cos(\text{sys2.phi}) * (\text{abs}(\text{sys2.phi}) < \pi/2) * \text{para}$	r
--	---

Start by improving the existing mesh in order to get a better resolution of stress gradients at the critical fillets.

## MESH 1

In the **Model Builder** window, expand the **Component 1 (comp1) > Mesh 1** node.

### Size 2

- 1 In the **Model Builder** window, expand the **Component 1 (comp1) > Mesh 1 > Free Tetrahedral 1** node, then click **Size 2**.
- 2 In the **Settings** window for **Size**, locate the **Geometric Entity Selection** section.
- 3 From the **Geometric entity level** list, choose **Boundary**.

- 4 Locate the **Element Size** section. Click the **Custom** button.
- 5 Locate the **Element Size Parameters** section.
- 6 Select the **Maximum element size** checkbox. In the associated text field, type 0.002.
- 7 Click  **Build Selected**.

## STUDY 1

Since it is an elastic case and the external load is proportional, only two load cases are necessary to capture the stress amplitude evaluated in the S-N curve.

### Step 1: Stationary

- 1 In the **Model Builder** window, expand the **Study 1** node, then click **Step 1: Stationary**.
- 2 In the **Settings** window for **Stationary**, click to expand the **Study Extensions** section.
- 3 Select the **Auxiliary sweep** checkbox.
- 4 Click  **Add**.
- 5 In the table, enter the following settings:

Parameter name	Parameter value list
para (Load cycle control)	0 1

- 6 In the **Study** toolbar, click  **Compute**.



## RESULTS

### Stress (solid)

Click the  **Show Grid** button in the **Graphics** toolbar.



## GLOBAL DEFINITIONS

### Interpolation 1 (int1)

- 1 In the **Home** toolbar, click  **Functions** and choose **Global > Interpolation**.
- 2 In the **Settings** window for **Interpolation**, locate the **Definition** section.
- 3 From the **Data source** list, choose **File**.
- 4 Click  **Browse**.
- 5 Browse to the model's Application Libraries folder and double-click the file `bracket_fatigue_sn_curve.txt`.
- 6 Locate the **Data Column Settings** section. In the table, click to select the cell at row number 2 and column number 1.
- 7 In the **Name** text field, type `wohler`.

8 Locate the **Definition** section. Click  **Import**.

### ADD PHYSICS



- 1 In the **Home** toolbar, click  **Add Physics** to open the **Add Physics** window.
- 2 Go to the **Add Physics** window.
- 3 Find the **Physics interfaces in study** subsection. In the table, clear the **Solve** checkbox for **Study I**.
- 4 In the tree, select **Structural Mechanics > Fatigue (ftg)**.
- 5 Click the **Add to Component I** button in the window toolbar.
- 6 In the **Home** toolbar, click  **Add Physics** to close the **Add Physics** window.

### FATIGUE (FTG)

#### *Stress-Life I*

- 1 In the **Physics** toolbar, click  **Boundaries** and choose **Stress-Life**.
- 2 In the **Settings** window for **Stress-Life**, locate the **Boundary Selection** section.
- 3 From the **Selection** list, choose **All boundaries**.
- 4 Locate the **Fatigue Model Selection** section. From the  $\sigma$  list, choose **Signed von Mises (principal)**.
- 5 From the **Modification** list, choose **Stress factor**.
- 6 Locate the **Solution Field** section. From the **Physics interface** list, choose **Solid Mechanics (solid)**.
- 7 Locate the **Fatigue Model Parameters** section. From the  $f_{SN}(N)$  list, choose **wohler**.
- 8 In the  $k$  text field, type  $k$ .
- 9 Locate the **Evaluation Settings** section. In the  $N_{cut}$  text field, type  $1e6$ .

### ADD STUDY

- 1 In the **Home** toolbar, click  **Add Study** to open the **Add Study** window.
- 2 Go to the **Add Study** window.
- 3 Find the **Physics interfaces in study** subsection. In the table, clear the **Solve** checkbox for **Solid Mechanics (solid)**.
- 4 Find the **Studies** subsection. In the **Select Study** tree, select **Preset Studies for Selected Physics Interfaces > Fatigue**.
- 5 Click the **Add Study** button in the window toolbar.
- 6 In the **Home** toolbar, click  **Add Study** to close the **Add Study** window.

## STUDY 2

### Step 1: Fatigue

- 1 In the **Settings** window for **Fatigue**, locate the **Values of Dependent Variables** section.
- 2 Find the **Values of variables not solved for** subsection. From the **Settings** list, choose **User controlled**.
- 3 From the **Method** list, choose **Solution**.
- 4 From the **Study** list, choose **Study 1, Stationary**.

### Parametric Sweep

- 1 In the **Study** toolbar, click  **Parametric Sweep**.
- 2 In the **Settings** window for **Parametric Sweep**, locate the **Study Settings** section.
- 3 Click **+ Add**.
- 4 In the table, enter the following settings:

Parameter name	Parameter value list
k (Stress factor)	0.7 0.28

- 5 In the **Study** toolbar, click  **Compute**.

## RESULTS

### Surface 1

- 1 In the **Model Builder** window, expand the **Cycles to Failure (ftg)** node, then click **Surface 1**.
- 2 In the **Settings** window for **Surface**, click to expand the **Quality** section.

3 In the **Cycles to Failure (ftg)** toolbar, click  **Plot**.

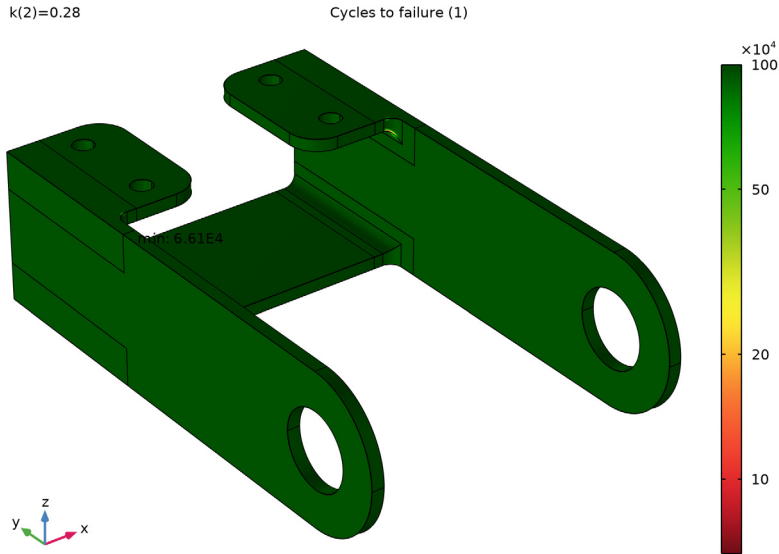

To get a better view of the critical points, you can rotate and zoom the bracket. For this purpose, it is useful to have a dedicated View node:

- 4 Click the  **Show More Options** button in the **Model Builder** toolbar.
- 5 In the **Show More Options** dialog, in the tree, select the checkbox for the node **Results > Views**.
- 6 Click **OK**.

*View 3D 2*

- 1 In the **Model Builder** window, under **Results** right-click **Views** and choose **View 3D**.
- 2 Use the mouse to rotate, zoom, and pan until you see the critical point up close.
- 3 Click the  **Show Grid** button in the **Graphics** toolbar.
- 4 In the **Settings** window for **View 3D**, locate the **View** section.
- 5 Select the **Lock camera** checkbox.

Now apply this view to the plots.

*Stress (solid)*

- 1 In the **Model Builder** window, under **Results** click **Stress (solid)**.
- 2 In the **Settings** window for **3D Plot Group**, locate the **Plot Settings** section.

- 3 From the **View** list, choose **View 3D 2**.
- 4 In the **Stress (solid)** toolbar, click  **Plot**.  
Compare the resulting plot with that in [Figure 3](#).

#### *Cycles to Failure (ftg)*

- 1 In the **Model Builder** window, click **Cycles to Failure (ftg)**.
- 2 In the **Settings** window for **3D Plot Group**, locate the **Plot Settings** section.
- 3 From the **View** list, choose **View 3D 2**.
- 4 Locate the **Color Legend** section. From the **Text color** list, choose **Cyan**.
- 5 Select the **Show maximum and minimum values** checkbox.
- 6 In the **Cycles to Failure (ftg)** toolbar, click  **Plot**.  
Compare with [Figure 4](#).

#### *Marker 1*

- 1 In the **Model Builder** window, expand the **Results > Cycles to Failure (ftg) > Surface 1** node.
- 2 Right-click **Marker 1** and choose **Disable**.
- 3 Right-click **Marker 1** and choose **Enable**.