



Model created in COMSOL Multiphysics 6.4

Electroplating of a Printed Circuit Board

Introduction

The printed circuit board (PCB) is the heart of almost any electronic product, carrying the components and copper wires supporting its functionality. This tutorial demonstrates how to simulate copper deposition on a PCB.

This model is also embedded in the *Printed Circuit Board Electroplating Designer* app, which adds a tailor-made user interface. In the app, functionality from the Optimization Module is also used to optimize various process parameters in order to, for instance, maximize the deposition rate for a given current distribution uniformity target. In the documentation for the app you can also read more about the PCB fabrication process in general.

The PCB pattern in the example is defined by imported ECAD files. The example requires an ECAD Module license.

Model Definition

The model uses the **Secondary Current Distribution** interface to simulate the current distribution in the deposition cell. Butler-Volmer kinetics is used on both electrode surfaces.

A Total Current boundary condition is used at the anode whereas the cathode is grounded (set to zero electronic potential).

The model geometry is shown in [Figure 1](#). The anodes are a set of stretched blocks at the top of the geometry. The cathode is the PCB pattern located at the center bottom of the cell. An isolating screen with an aperture is placed between the anodes and the cathode to control the current distribution on the PCB. The deposition pattern also contains certain

“dummy” parts (current thieves), not used in the final PCB product, that are used in order to make the deposition rate on the PCB more uniform.

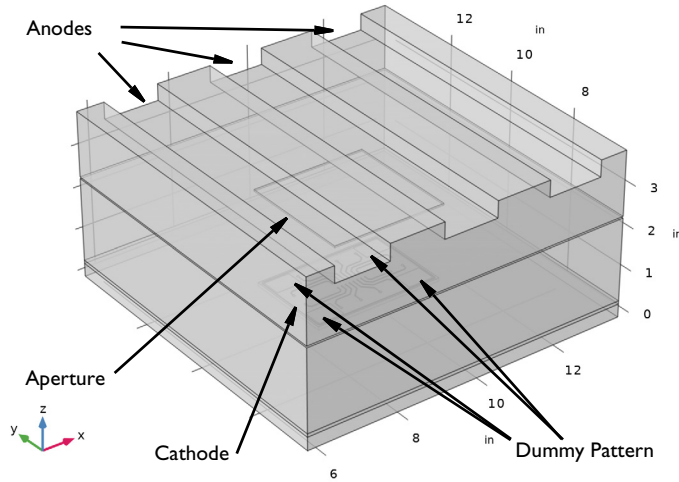

Figure 1: The model geometry.

The conductivity of the metal of the anodes and cathode is very high compared to that of the electrolyte and it is assumed that the electric potential in the metal is constant. The variations in the activation overpotential are therefore caused by the potential in the electrolyte at the surface of the electrodes. Under these assumptions, the electrodes are treated as boundaries in the simulations.

The Secondary Current Distribution interface solves for the electrolyte potential, ϕ_l (V), according to:

$$\begin{aligned}\mathbf{i}_l &= -\sigma_l \nabla \phi_l \\ \nabla \cdot \mathbf{i}_l &= 0\end{aligned}$$

where \mathbf{i}_l (A/m²) is the electrolyte current density vector and σ_l (S/m) is the electrolyte conductivity, which is assumed to be a constant.

The default Insulation condition is used for all boundaries except the anode and cathode surfaces:

$$\mathbf{n} \cdot \mathbf{i}_l = 0$$

where \mathbf{n} is the normal vector, pointing out of the domain.

The main electrode reaction on both the anode and the cathode surfaces is the copper deposition/dissolution reaction,

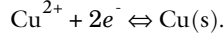

A Butler–Volmer Expression is used to model this reaction; this sets the local current density to

$$i_{\text{loc}} = i_0 \left(\exp\left(\frac{\alpha_a F \eta}{RT}\right) - \exp\left(-\frac{\alpha_c F \eta}{RT}\right) \right)$$

Note that the local current density is positive at the anode surface and negative at the cathode surfaces, depending on the sign of the overpotential, η (V), defined as

$$\eta = \phi_s - \phi_l - E_{\text{eq}} \quad (1)$$

where E_{eq} (V) is the equilibrium potential of the copper dissolution/deposition reaction and ϕ_s (V) is the potential of the electronic phase of the electrode.

On both the anode and the cathode the electrolyte current density is set to the local current density of the copper deposition reaction:

$$\mathbf{n} \cdot \mathbf{i}_l = i_{\text{loc}} \quad (2)$$

The anode is grounded in the model whereas the cathode electric potential is solved for by an additional equation in order to fulfill a total current condition on the boundary according to

$$\int i_{\text{loc}} = I_{\text{total}} = I_{\text{avg}} A_{\text{cathode}} \quad (3)$$

The model is solved in a stationary study.

When postprocessing the solution the deposition thickness, s (m), at the PCB is calculated according to

$$s = \frac{i_{\text{loc}}}{I_{\text{avg}}} s_{\text{target}} \quad (4)$$

where s_{target} (m) is the target mean deposition thickness for the whole cathode.

The time needed to achieve this thickness, t_{dep} (m), is related to s_{target} according to

$$t_{\text{dep}} = s_{\text{target}} \frac{nF \rho}{I_{\text{avg}} M} \quad (5)$$

where M is the mean molar mass (63.55 g/mol) and ρ is the density (8960 kg/m³) of the copper atoms and n (=2) is the number of participating electrons.

Results and Discussion

Figure 2 shows the current density on the cathode, excluding the dummy pattern, for an average current density of 2 A/dm², and Figure 3 shows the corresponding deposited thickness for a target deposition thickness of 10 μm .

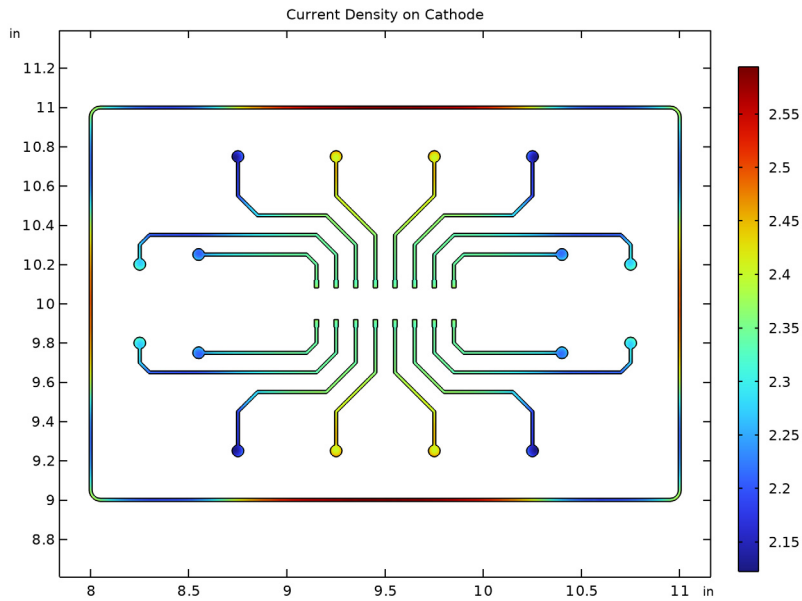

Figure 2: Current density at PCB pattern, excluding the dummy pattern (current thief).

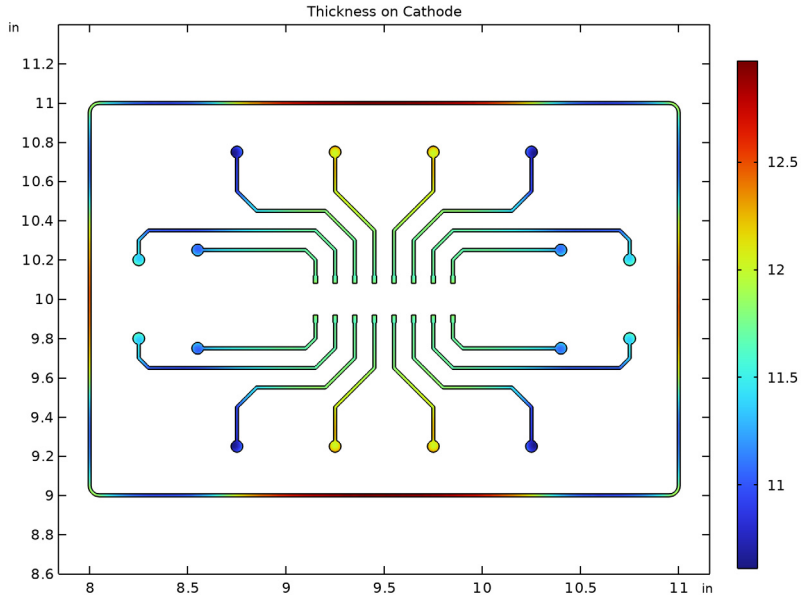

Figure 3: Deposition thickness of the PCB pattern for a target thickness of $10\ \mu\text{m}$.

Figure 4 shows the effect of the aperture on the field lines, and the thickness for the whole cathode including the dummy pattern. The deposition thickness is lower than $10\ \mu\text{m}$ for the dummy parts of the PCB.

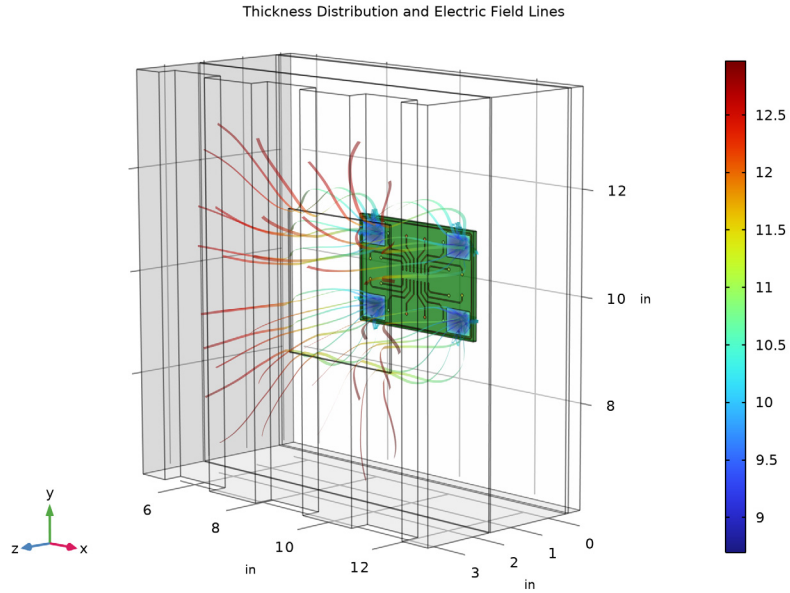



Figure 4: Field lines and thickness on the cathode, including the dummy pattern.

Application Library path: Electrodeposition_Module/Tutorials/pcb_designer



Modeling Instructions

From the **File** menu, choose **New**.

NEW

In the **New** window, click  **Model Wizard**.

MODEL WIZARD

- 1 In the **Model Wizard** window, click  **3D**.
- 2 In the **Select Physics** tree, select **Electrochemistry** > **Primary and Secondary Current Distribution** > **Secondary Current Distribution (cd)**.
- 3 Click **Add**.
- 4 Click  **Study**.

5 In the **Select Study** tree, select **General Studies > Stationary**.

6 Click  **Done**.

GLOBAL DEFINITIONS

Load parameters from a file.

Parameters 1

1 In the **Model Builder** window, under **Global Definitions** click **Parameters 1**.

2 In the **Settings** window for **Parameters**, locate the **Parameters** section.

3 Click  **Load from File**.

4 Browse to the model's Application Libraries folder and double-click the file `pcb_designer_parameters.txt`.

GEOMETRY 1

This model utilizes a premade geometry file containing a PCB pattern imported from an ECAD file. The model geometry is available as a parameterized geometry sequence in a separate MPH file. If you want to build it from scratch, follow the instructions in the section [Appendix — Geometry Modeling Instructions](#). Otherwise load it from file with the following steps.

1 In the **Geometry** toolbar, click **Insert Sequence** and choose **Insert Sequence**.

2 Browse to the model's Application Libraries folder and double-click the file `pcb_designer_geom_sequence.mph`.

3 In the **Geometry** toolbar, click  **Build All**.

Use the transparency button to see the entire geometry clearly.

4 Click the  **Transparency** button in the **Graphics** toolbar.

Create some selections that will be used during model setup.

Electrolyte swept mesh region 2

1 In the **Geometry** toolbar, click  **Selections** and choose **Box Selection**.



2 In the **Settings** window for **Box Selection**, type Electrolyte swept mesh region 2 in the **Label** text field.

3 Locate the **Box Limits** section. In the **z minimum** text field, type 0.





4 In the **z maximum** text field, type 0.

Electrolyte swept mesh regions



1 In the **Geometry** toolbar, click  **Selections** and choose **Union Selection**.

- 2 In the **Settings** window for **Union Selection**, type Electrolyte swept mesh regions in the **Label** text field.
- 3 Locate the **Input Entities** section. Click  **Add**.
- 4 In the **Add** dialog, in the **Selections to add** list, choose **Electrolyte swept mesh region 1** and **Electrolyte swept mesh region 2**.
- 5 Click **OK**.
- 6 In the **Settings** window for **Union Selection**, click  **Build Selected**.

PCB top dielectric





- 1 In the **Geometry** toolbar, click  **Selections** and choose **Adjacent Selection**.
- 2 In the **Settings** window for **Adjacent Selection**, type PCB top dielectric in the **Label** text field.
- 3 Locate the **Input Entities** section. Click  **Add**.
- 4 In the **Add** dialog, select **Cathode** in the **Input selections** list.
- 5 Click **OK**.
- 6 In the **Settings** window for **Adjacent Selection**, locate the **Input Entities** section.
- 7 From the **Geometric entity level** list, choose **Boundary**.
- 8 Click  **Add**.
- 9 In the **Add** dialog, select **Cathode** in the **Input selections** list.
- 10 Click **OK**.
- 11 In the **Settings** window for **Adjacent Selection**, click  **Build Selected**.

PCB top

- 1 In the **Geometry** toolbar, click  **Selections** and choose **Union Selection**.
- 2 In the **Settings** window for **Union Selection**, type PCB top in the **Label** text field.
- 3 Locate the **Geometric Entity Level** section. From the **Level** list, choose **Boundary**.
- 4 Locate the **Input Entities** section. Click  **Add**.
- 5 In the **Add** dialog, in the **Selections to add** list, choose **Cathode** and **PCB top dielectric**.
- 6 Click **OK**.
- 7 In the **Settings** window for **Union Selection**, click  **Build Selected**.

PCB without cathode

- 1 In the **Geometry** toolbar, click  **Selections** and choose **Difference Selection**.
- 2 In the **Settings** window for **Difference Selection**, type PCB without cathode in the **Label** text field.

- 3 Locate the **Input Entities** section. Click the  **Add** button for **Selections to add**.
- 4 In the **Add** dialog, select **PCB** in the **Selections to add** list.
- 5 Click **OK**.
- 6 In the **Settings** window for **Difference Selection**, locate the **Input Entities** section.
- 7 Click the  **Add** button for **Selections to subtract**.
- 8 In the **Add** dialog, select **Cathode** in the **Selections to subtract** list.
- 9 Click **OK**.
- 10 In the **Settings** window for **Difference Selection**, locate the **Geometric Entity Level** section.
- 11 From the **Level** list, choose **Boundary**.
- 12 Locate the **Input Entities** section. Click the  **Add** button for **Selections to add**.
- 13 In the **Add** dialog, select **PCB** in the **Selections to add** list.
- 14 Click **OK**.
- 15 In the **Settings** window for **Difference Selection**, locate the **Input Entities** section.
- 16 Click the  **Add** button for **Selections to subtract**.
- 17 In the **Add** dialog, select **Cathode** in the **Selections to subtract** list.
- 18 Click **OK**.

Disable the analysis of the geometry as the remaining small geometric details are needed.

- 19 In the **Model Builder** window, click **Geometry I**.
- 20 In the **Settings** window for **Geometry**, locate the **Cleanup** section.
- 21 Clear the **Automatic detection of small details** checkbox.
- 22 In the **Geometry** toolbar, click  **Build All**.

DEFINITIONS

Add an integration coupling variable and load variables from a text file.

Integration I (intop1)

- 1 In the **Definitions** toolbar, click  **Nonlocal Couplings** and choose **Integration**.
- 2 In the **Settings** window for **Integration**, locate the **Source Selection** section.
- 3 From the **Geometric entity level** list, choose **Boundary**.
- 4 From the **Selection** list, choose **Cathode**.

Variables I

- 1 In the **Model Builder** window, right-click **Definitions** and choose **Variables**.

- 2 In the **Settings** window for **Variables**, locate the **Variables** section.
- 3 Click  **Load from File**.
- 4 Browse to the model's Application Libraries folder and double-click the file `pcb_designer_variables.txt`.

MATERIALS

Add a material to specify the electrolyte conductivity.

Electrolyte

- 1 In the **Model Builder** window, under **Component 1 (comp1)** right-click **Materials** and choose **Blank Material**.
- 2 In the **Settings** window for **Material**, type **Electrolyte** in the **Label** text field.
- 3 Locate the **Material Contents** section. In the table, enter the following settings:

Property	Variable	Value	Unit	Property group
Electrolyte conductivity	<code>sigma_iso ; sigma_ii = sigma_iso, sigma_ij = 0</code>	50	S/m	Electrolyte conductivity

SECONDARY CURRENT DISTRIBUTION (CD)

Define the physics settings in the Secondary Current Distribution interface.

Electrode Surface 1

- 1 In the **Physics** toolbar, click  **Boundaries** and choose **Electrode Surface**.
- 2 In the **Settings** window for **Electrode Surface**, locate the **Boundary Selection** section.
- 3 From the **Selection** list, choose **Cathode**.
- 4 Locate the **Electrode Phase Potential Condition** section. From the **Electrode phase potential condition** list, choose **Total current**.
- 5 In the $I_{l,total}$ text field, type `-ItotCathode`.

Electrode Reaction 1

- 1 In the **Model Builder** window, click **Electrode Reaction 1**.
- 2 In the **Settings** window for **Electrode Reaction**, locate the **Electrode Kinetics** section.
- 3 From the **Kinetics expression type** list, choose **Butler–Volmer**.
- 4 In the i_0 text field, type `i0`.
- 5 In the α_a text field, type `alphaa`.

Electrode Surface 2

- 1 In the **Physics** toolbar, click  **Boundaries** and choose **Electrode Surface**.
- 2 In the **Settings** window for **Electrode Surface**, locate the **Boundary Selection** section.
- 3 From the **Selection** list, choose **Anode**.

Electrode Reaction 1

- 1 In the **Model Builder** window, click **Electrode Reaction 1**.
- 2 In the **Settings** window for **Electrode Reaction**, locate the **Electrode Kinetics** section.
- 3 From the **Kinetics expression type** list, choose **Butler–Volmer**.
- 4 In the i_0 text field, type i_0 .
- 5 In the α_a text field, type α_a .

Initial Values 1

- 1 In the **Model Builder** window, under **Component 1 (comp1) > Secondary Current Distribution (cd)** click **Initial Values 1**.
- 2 In the **Settings** window for **Initial Values**, locate the **Initial Values** section.
- 3 In the *phil* text field, type `phil_initial`.

MESH 1

Generate the mesh as follows.

Free Triangular 1

In the **Mesh** toolbar, click  **More Generators** and choose **Free Triangular**.

Size

- 1 In the **Model Builder** window, click **Size**.
- 2 In the **Settings** window for **Size**, locate the **Element Size** section.
- 3 From the **Predefined** list, choose **Fine**.

Free Triangular 1



- 1 In the **Model Builder** window, click **Free Triangular 1**.
- 2 In the **Settings** window for **Free Triangular**, locate the **Boundary Selection** section.
- 3 From the **Selection** list, choose **PCB top**.

Size 1

- 1 Right-click **Free Triangular 1** and choose **Size**.
- 2 In the **Settings** window for **Size**, locate the **Geometric Entity Selection** section.
- 3 From the **Selection** list, choose **Cathode**.

4 Locate the **Element Size** section. From the **Predefined** list, choose **Extra fine**.

Swept 1

- 1 In the **Mesh** toolbar, click  **Swept**.
- 2 In the **Settings** window for **Swept**, locate the **Domain Selection** section.
- 3 From the **Geometric entity level** list, choose **Domain**.
- 4 From the **Selection** list, choose **Electrolyte swept mesh regions**.
- 5 Click to expand the **Source Faces** section. Click  **Paste Selection**.
- 6 In the **Paste Selection** dialog, type 9 in the **Selection** text field.
- 7 Click **OK**.
- 8 In the **Settings** window for **Swept**, locate the **Mesh Generation** section.
- 9 From the **Elements** list, choose **Prisms**.

Size 1

- 1 Right-click **Swept 1** and choose **Size**.
- 2 In the **Settings** window for **Size**, locate the **Geometric Entity Selection** section.
- 3 From the **Geometric entity level** list, choose **Boundary**.
- 4 Click  **Paste Selection**.
- 5 In the **Paste Selection** dialog, type 9 in the **Selection** text field.
- 6 Click **OK**.
- 7 In the **Settings** window for **Size**, locate the **Element Size** section.
- 8 From the **Predefined** list, choose **Finer**.

Distribution 1

- 1 In the **Model Builder** window, right-click **Swept 1** and choose **Distribution**.
- 2 In the **Settings** window for **Distribution**, locate the **Distribution** section.
- 3 In the **Number of elements** text field, type $\text{round}((\text{PCBThickness}/1.5[\text{mm}] \geq 1) * \text{PCBThickness}/1.5[\text{mm}] + (\text{PCBThickness}/1.5[\text{mm}] < 1), 0)$.

Distribution 2

- 1 Right-click **Swept 1** and choose **Distribution**.
- 2 In the **Settings** window for **Distribution**, locate the **Domain Selection** section.
- 3 From the **Selection** list, choose **Electrolyte swept mesh region 2**.
- 4 Locate the **Distribution** section. In the **Number of elements** text field, type $((\text{PCBOffset} - \text{PCBThickness}) / 2[\text{mm}] \geq 1) * (\text{PCBOffset} - \text{PCBThickness}) / 2[\text{mm}] + ((\text{PCBOffset} - \text{PCBThickness}) / 2[\text{mm}] < 1)$.

Swept 2

- 1 In the **Mesh** toolbar, click  **Swept**.
- 2 In the **Settings** window for **Swept**, locate the **Domain Selection** section.
- 3 From the **Geometric entity level** list, choose **Domain**.
- 4 From the **Selection** list, choose **Aperture**.
- 5 Locate the **Source Faces** section. From the **Selection** list, choose **Aperture source**.
- 6 Locate the **Mesh Generation** section. From the **Elements** list, choose **Prisms**.

Size 1

- 1 Right-click **Swept 2** and choose **Size**.
- 2 In the **Settings** window for **Size**, locate the **Geometric Entity Selection** section.
- 3 From the **Geometric entity level** list, choose **Boundary**.
- 4 From the **Selection** list, choose **Aperture source**.
- 5 Locate the **Element Size** section. From the **Predefined** list, choose **Finer**.

Distribution 1

- 1 In the **Model Builder** window, right-click **Swept 2** and choose **Distribution**.
- 2 In the **Settings** window for **Distribution**, locate the **Distribution** section.
- 3 In the **Number of elements** text field, type $(ApertureThickness/1.5[mm]) \geq 1) * ApertureThickness/1.5[mm] + (ApertureThickness/1.5[mm] < 1)$.

Free Tetrahedral 1

- 1 In the **Mesh** toolbar, click  **Free Tetrahedral**.
- 2 In the **Model Builder** window, right-click **Mesh 1** and choose **Build All**.

STUDY 1

Step 1: Stationary

- 1 In the **Model Builder** window, under **Study 1** click **Step 1: Stationary**.
- 2 In the **Settings** window for **Stationary**, locate the **Study Settings** section.
- 3 From the **Tolerance** list, choose **User controlled**.
- 4 In the **Relative tolerance** text field, type $1e-6$.
- 5 In the **Model Builder** window, click **Study 1**.
- 6 In the **Settings** window for **Study**, locate the **Study Settings** section.
- 7 Clear the **Generate default plots** checkbox.

Finally, compute the results.

8 In the **Study** toolbar, click  **Compute**.

RESULTS

Create some datasets that will be used during postprocessing.

Cathode

- 1 In the **Model Builder** window, expand the **Results** node.
- 2 Right-click **Results** > **Datasets** and choose **Surface**.
- 3 In the **Settings** window for **Surface**, type Cathode in the **Label** text field.
- 4 Locate the **Parameterization** section. From the **x- and y-axes** list, choose **Expression**.
- 5 Locate the **Selection** section. From the **Selection** list, choose **Cathode**.



Cathode copper layout

- 1 In the **Results** toolbar, click  **More Datasets** and choose **Surface**.
- 2 In the **Settings** window for **Surface**, type Cathode copper layout in the **Label** text field.
- 3 Locate the **Parameterization** section. From the **x- and y-axes** list, choose **Expression**.
- 4 Locate the **Selection** section. From the **Selection** list, choose **PCB copper layout**.

PCB without cathode

- 1 In the **Results** toolbar, click  **More Datasets** and choose **Surface**.
- 2 In the **Settings** window for **Surface**, type PCB without cathode in the **Label** text field.
- 3 Locate the **Selection** section. From the **Selection** list, choose **PCB without cathode**.

Walls

- 1 In the **Results** toolbar, click  **More Datasets** and choose **Surface**.
- 2 In the **Settings** window for **Surface**, type Walls in the **Label** text field.
- 3 Locate the **Selection** section. Click  **Paste Selection**.
- 4 In the **Paste Selection** dialog, type 1-5, 7-8, 11-12 in the **Selection** text field.
- 5 Click **OK**.

Thickness on Cathode

First, plot the thickness on the cathode copper layout.

- 1 In the **Results** toolbar, click  **2D Plot Group**.
- 2 In the **Settings** window for **2D Plot Group**, type Thickness on Cathode in the **Label** text field.
- 3 Locate the **Data** section. From the **Dataset** list, choose **Cathode copper layout**.

Surface 1

- 1 Right-click **Thickness on Cathode** and choose **Surface**.
- 2 In the **Settings** window for **Surface**, click **Replace Expression** in the upper-right corner of the **Expression** section. From the menu, choose **Component 1 (comp1) > Definitions > Variables > thickness_cathode - Thickness on cathode - m**.
- 3 Locate the **Expression** section. From the **Unit** list, choose **µm**.

Thickness on Cathode

- 1 In the **Model Builder** window, click **Thickness on Cathode**.
- 2 In the **Settings** window for **2D Plot Group**, click to expand the **Title** section.
- 3 From the **Title type** list, choose **Label**.

Current Density on Cathode

Next, plot the current density on the cathode copper layout.

- 1 Right-click **Thickness on Cathode** and choose **Duplicate**.
- 2 In the **Model Builder** window, click **Thickness on Cathode 1**.
- 3 In the **Settings** window for **2D Plot Group**, type **Current Density on Cathode** in the **Label** text field.

Surface 1

- 1 In the **Model Builder** window, click **Surface 1**.
- 2 In the **Settings** window for **Surface**, click **Replace Expression** in the upper-right corner of the **Expression** section. From the menu, choose **Component 1 (comp1) > Secondary Current Distribution > Electrode kinetics > cd.iloc_er1 - Local current density - A/m²**.
- 3 Locate the **Expression** section. In the **Expression** text field, type `-cd.iloc_er1`.
- 4 In the **Unit** field, type `A/dm2`.
- 5 Select the **Description** checkbox. In the associated text field, type **Current Density on Cathode**.

Current Density on Cathode

- 1 In the **Model Builder** window, click **Current Density on Cathode**.
- 2 In the **Current Density on Cathode** toolbar, click  **Plot**.

Thickness Distribution and Electric Field Lines

Next, plot the thickness distribution and the electric field lines.

- 1 In the **Results** toolbar, click  **3D Plot Group**.

- 2 In the **Settings** window for **3D Plot Group**, type **Thickness Distribution and Electric Field Lines** in the **Label** text field.

Surface 1

- 1 Right-click **Thickness Distribution and Electric Field Lines** and choose **Surface**.
- 2 In the **Settings** window for **Surface**, locate the **Data** section.
- 3 From the **Dataset** list, choose **Cathode**.
- 4 Locate the **Expression** section. In the **Expression** text field, type **thickness_cathode**.
- 5 From the **Unit** list, choose **µm**.

Surface 2

- 1 In the **Model Builder** window, right-click **Thickness Distribution and Electric Field Lines** and choose **Surface**.
- 2 In the **Settings** window for **Surface**, locate the **Data** section.
- 3 From the **Dataset** list, choose **PCB without cathode**.
- 4 Locate the **Coloring and Style** section. From the **Coloring** list, choose **Uniform**.
- 5 From the **Color** list, choose **Custom**.
- 6 On Windows, click the colored bar underneath, or — if you are running the cross-platform desktop — the **Color** button.
- 7 Click **Define custom colors**.
- 8 Set the RGB values to 9, 118, and 9, respectively.
- 9 Click **Add to custom colors**.
- 10 Click **Show color palette only** or **OK** on the cross-platform desktop.

Surface 3

- 1 Right-click **Thickness Distribution and Electric Field Lines** and choose **Surface**.
- 2 In the **Settings** window for **Surface**, locate the **Data** section.
- 3 From the **Dataset** list, choose **Walls**.
- 4 Locate the **Expression** section. In the **Expression** text field, type 1.
- 5 Locate the **Coloring and Style** section. From the **Coloring** list, choose **Uniform**.
- 6 From the **Color** list, choose **White**.

Streamline 1

- 1 Right-click **Thickness Distribution and Electric Field Lines** and choose **Streamline**.
- 2 In the **Settings** window for **Streamline**, locate the **Streamline Positioning** section.
- 3 In the **Number** text field, type 50.

- 4 Locate the **Selection** section. From the **Selection** list, choose **Cathode**.
- 5 Locate the **Coloring and Style** section. Find the **Line style** subsection. From the **Type** list, choose **Ribbon**.

Color Expression I

- 1 Right-click **Streamline I** and choose **Color Expression**.
- 2 In the **Settings** window for **Color Expression**, locate the **Coloring and Style** section.
- 3 Clear the **Color legend** checkbox.

Thickness Distribution and Electric Field Lines

- 1 In the **Model Builder** window, under **Results** click **Thickness Distribution and Electric Field Lines**.
- 2 In the **Settings** window for **3D Plot Group**, click to expand the **Title** section.
- 3 From the **Title type** list, choose **Label**.
- 4 In the **Thickness Distribution and Electric Field Lines** toolbar, click  **Plot**.



Appendix — Geometry Modeling Instructions

From the **File** menu, choose **New**.

NEW

In the **New** window, click  **Model Wizard**.

MODEL WIZARD

- 1 In the **Model Wizard** window, click  **3D**.
- 2 Click  **Done**.

GLOBAL DEFINITIONS



Parameters I

- 1 In the **Model Builder** window, under **Global Definitions** click **Parameters I**.
- 2 In the **Settings** window for **Parameters**, locate the **Parameters** section.
- 3 Click  **Load from File**.
- 4 Browse to the model's Application Libraries folder and double-click the file `pcb_designer_geom_sequence_parameters.txt`.



GEOMETRY 1

- 1 In the **Model Builder** window, under **Component 1 (comp1)** click **Geometry 1**.
- 2 In the **Settings** window for **Geometry**, locate the **Units** section.
- 3 From the **Length unit** list, choose **in**.



PCB

- 1 In the **Geometry** toolbar, click  **Block**.
- 2 In the **Settings** window for **Block**, type PCB in the **Label** text field.
- 3 Locate the **Size and Shape** section. In the **Width** text field, type $PCBWidth+2*PCBMargin$.
- 4 In the **Depth** text field, type $PCBHeight+2*PCBMargin$.
- 5 In the **Height** text field, type $PCBThickness$.
- 6 Locate the **Position** section. In the **x** text field, type $PCBxMin-PCBMargin$.
- 7 In the **y** text field, type $PCByMin-PCBMargin$.
- 8 In the **z** text field, type $PCBOffset-PCBThickness$.
- 9 Locate the **Selections of Resulting Entities** section. Select the **Resulting objects selection** checkbox.
- 10 Click the  **Transparency** button in the **Graphics** toolbar.

Work Plane 1 (wp1)

- 1 In the **Geometry** toolbar, click  **Work Plane**.
- 2 In the **Settings** window for **Work Plane**, locate the **Plane Definition** section.
- 3 In the **z-coordinate** text field, type $PCBOffset$.
- 4 Locate the **Selections of Resulting Entities** section. Find the **Cumulative selection** subsection. Click **New**.
- 5 In the **New Cumulative Selection** dialog, type PCB copper layout in the **Name** text field.
- 6 Click **OK**.
- 7 In the **Settings** window for **Work Plane**, click  **Go to Plane Geometry**.

Work Plane 1 (wp1) > Import 1 (imp1)

- 1 In the **Home** toolbar, click  **Import**.
- 2 In the **Settings** window for **Import**, locate the **Source** section.
- 3 Click  **Browse**.
- 4 Browse to the model's Application Libraries folder and double-click the file `example_pcb.tgz`.

5 Click  **Import**.

6 Locate the **Layers** section. In the table, clear the **Import** checkbox for **Dielectric**.

GEOMETRY 1

Work Plane 1 (wp1)

In the **Model Builder** window, collapse the **Component 1 (comp1) > Geometry 1 > Work Plane 1 (wp1)** node.

If 1 (if1)

1 In the **Model Builder** window, right-click **Geometry 1** and choose **Programming > If + End If**.

2 In the **Settings** window for **If**, locate the **If** section.

3 In the **Condition** text field, type UseDummy.

Work Plane 2 (wp2)

1 In the **Geometry** toolbar, click  **Work Plane**.

2 In the **Settings** window for **Work Plane**, locate the **Plane Definition** section.

3 In the **z-coordinate** text field, type PCBOffset.

4 Locate the **Selections of Resulting Entities** section. Find the **Cumulative selection** subsection. Click **New**.

5 In the **New Cumulative Selection** dialog, type PCB dummy layout in the **Name** text field.

6 Click **OK**.

7 In the **Settings** window for **Work Plane**, click  **Go to Plane Geometry**.

Work Plane 2 (wp2) > Import 1 (imp1)

1 In the **Home** toolbar, click  **Import**.

2 In the **Settings** window for **Import**, locate the **Source** section.

3 Click  **Browse**.

4 Browse to the model's Application Libraries folder and double-click the file example_pcb_dummy_pattern.tgz.

5 Click  **Import**.

6 Locate the **Layers** section. In the table, clear the **Import** checkbox for **Dielectric**.

End If 1 (endif1)

1 In the **Model Builder** window, under **Component 1 (comp1) > Geometry 1** click **End If 1 (endif1)**.

- 2 In the **Settings** window for **End If**, click  **Build All Objects**.

Cathode

- 1 In the **Model Builder** window, right-click **Geometry 1** and choose **Selections > Union Selection**.
- 2 In the **Settings** window for **Union Selection**, type Cathode in the **Label** text field.
- 3 Locate the **Geometric Entity Level** section. From the **Level** list, choose **Object**.
- 4 Locate the **Input Entities** section. Click  **Add**.
- 5 In the **Add** dialog, in the **Selections to add** list, choose **PCB copper layout** and **PCB dummy layout**.
- 6 Click **OK**.

Bath



- 1 In the **Geometry** toolbar, click  **Block**.
- 2 In the **Settings** window for **Block**, type Bath in the **Label** text field.
- 3 Locate the **Size and Shape** section. In the **Width** text field, type BathWidth.
- 4 In the **Depth** text field, type BathHeight.
- 5 In the **Height** text field, type BathDepth.
- 6 Locate the **Position** section. In the **x** text field, type $PCBxMin - (BathWidth - PCBWidth) / 2$.
- 7 In the **y** text field, type $PCByMin - (BathHeight - PCBHeight) / 2$.
- 8 Locate the **Selections of Resulting Entities** section. Select the **Resulting objects selection** checkbox.

Electrolyte swept mesh region 1

- 1 In the **Geometry** toolbar, click  **Block**.
- 2 In the **Settings** window for **Block**, type Electrolyte swept mesh region 1 in the **Label** text field.
- 3 Locate the **Size and Shape** section. In the **Width** text field, type BathWidth.
- 4 In the **Depth** text field, type BathHeight.
- 5 In the **Height** text field, type PCBThickness.
- 6 Locate the **Position** section. In the **x** text field, type $PCBxMin - (BathWidth - PCBWidth) / 2$.
- 7 In the **y** text field, type $PCByMin - (BathHeight - PCBHeight) / 2$.
- 8 In the **z** text field, type $PCBOffset - PCBThickness$.

- 9 Locate the **Selections of Resulting Entities** section. Select the **Resulting objects selection** checkbox.



Work Plane 3 (wp3)

- 1 In the **Geometry** toolbar, click  **Work Plane**.
- 2 In the **Settings** window for **Work Plane**, locate the **Plane Definition** section.
- 3 From the **Plane type** list, choose **Face parallel**.
- 4 Click the  **Zoom Extents** button in the **Graphics** toolbar.
- 5 On the object **blk2**, select Boundary 4 only.
- 6 Click  **Go to Plane Geometry**.

Work Plane 3 (wp3) > Rectangle 1 (r1)

- 1 In the **Work Plane** toolbar, click  **Rectangle**.
- 2 In the **Settings** window for **Rectangle**, locate the **Size and Shape** section.
- 3 In the **Width** text field, type $\text{BathWidth}/6$.
- 4 In the **Height** text field, type BathHeight .
- 5 Locate the **Position** section. In the **xw** text field, type $-\text{BathWidth}/2+\text{BathWidth}/6/2$.
- 6 In the **yw** text field, type $-\text{BathHeight}/2$.

Work Plane 3 (wp3) > Array 1 (arr1)

- 1 In the **Work Plane** toolbar, click  **Transforms** and choose **Array**.
- 2 Click the  **Zoom Extents** button in the **Graphics** toolbar.
- 3 Select the object **r1** only.
- 4 In the **Model Builder** window, click **Array 1 (arr1)**.
- 5 In the **Settings** window for **Array**, locate the **Size** section.
- 6 In the **xw size** text field, type 3.
- 7 Locate the **Displacement** section. In the **xw** text field, type $\text{BathWidth}/3$.

GEOMETRY 1

Work Plane 3 (wp3)

In the **Model Builder** window, collapse the **Component 1 (comp1) > Geometry 1 > Work Plane 3 (wp3)** node.

Anode

- 1 In the **Geometry** toolbar, click  **Extrude**.
- 2 In the **Settings** window for **Extrude**, type **Anode** in the **Label** text field.

3 Locate the **Distances** section. In the table, enter the following settings:

Distances (in)
AnodeThickness

4 Select the **Reverse direction** checkbox.

5 Locate the **Selections of Resulting Entities** section. Select the **Resulting objects selection** checkbox.

6 From the **Show in physics** list, choose **Boundary selection**.

Difference 1 (dif1)

1 In the **Model Builder** window, right-click **Geometry 1** and choose **Booleans and Partitions** > **Difference**.

2 Select the objects **blk2** and **blk3** only.

3 In the **Settings** window for **Difference**, locate the **Difference** section.

4 Click to select the  **Activate Selection** toggle button for **Objects to subtract**.

5 From the **Objects to subtract** list, choose **PCB**.

6 Select the objects **blk1** and **ext1** only.

If 2 (if2)

1 In the **Geometry** toolbar, click  **Programming** and choose **If + End If**.

2 In the **Settings** window for **If**, locate the **If** section.

3 In the **Condition** text field, type UseAperture.

Work Plane 4 (wp4)

1 In the **Geometry** toolbar, click  **Work Plane**.

2 In the **Settings** window for **Work Plane**, locate the **Plane Definition** section.

3 In the **z-coordinate** text field, type ApertureOffset+PCBOffset.

4 Click  **Go to Plane Geometry**.

Work Plane 4 (wp4) > Cross Section 1 (cro1)

1 In the **Work Plane** toolbar, click  **Cross Section**.

2 In the **Settings** window for **Cross Section**, locate the **Cross Section** section.

3 From the **Intersect** list, choose **Selected objects**.

4 From the **Objects to intersect** list, choose **Bath**.

GEOMETRY 1

Work Plane 4 (wp4)

- 1 In the **Model Builder** window, collapse the **Component 1 (comp1) > Geometry 1 > Work Plane 4 (wp4)** node.
- 2 In the **Model Builder** window, click **Work Plane 4 (wp4)**.
- 3 In the **Settings** window for **Work Plane**, click  **Build Selected**.



Extrude 2 (ext2)

- 1 In the **Model Builder** window, right-click **Geometry 1** and choose **Extrude**.
- 2 In the **Settings** window for **Extrude**, locate the **Distances** section.
- 3 In the table, enter the following settings:



Distances (in)
ApertureThickness

- 4 Click  **Build Selected**.

Difference 2 (dif2)

- 1 In the **Geometry** toolbar, click  **Booleans and Partitions** and choose **Difference**.
- 2 Select the object **dif1** only.
- 3 In the **Settings** window for **Difference**, locate the **Difference** section.
- 4 Click to select the  **Activate Selection** toggle button for **Objects to subtract**.
- 5 Select the object **ext2** only.
- 6 Click  **Build Selected**.

Aperture source

- 1 In the **Geometry** toolbar, click  **Work Plane**.
- 2 In the **Settings** window for **Work Plane**, type Aperture source in the **Label** text field.
- 3 Locate the **Plane Definition** section. In the **z-coordinate** text field, type ApertureOffset+PCBOffset.
- 4 Locate the **Selections of Resulting Entities** section. Select the **Resulting objects selection** checkbox.
- 5 Click  **Go to Plane Geometry**.

Aperture source (wp5) > Rectangle 1 (r1)

- 1 In the **Work Plane** toolbar, click  **Rectangle**.
- 2 In the **Settings** window for **Rectangle**, locate the **Size and Shape** section.

- 3 In the **Width** text field, type ApertureWidth.
- 4 In the **Height** text field, type ApertureHeight.
- 5 Locate the **Position** section. In the **xw** text field, type $PCBxMin - (BathWidth - PCBWidth) / 2 + (BathWidth - ApertureWidth) / 2$.
- 6 In the **yw** text field, type $PCByMin - (BathHeight - PCBHeight) / 2 + (BathHeight - ApertureHeight) / 2$.

Aperture source (wp5)

- 1 In the **Model Builder** window, collapse the **Component 1 (comp1) > Geometry 1 > Aperture source (wp5)** node.
- 2 In the **Model Builder** window, click **Aperture source (wp5)**.
- 3 In the **Settings** window for **Work Plane**, click  **Build Selected**.

Aperture

- 1 In the **Geometry** toolbar, click  **Extrude**.
- 2 In the **Settings** window for **Extrude**, type Aperture in the **Label** text field.
- 3 Locate the **Distances** section. In the table, enter the following settings:

Distances (in)
ApertureThickness

- 4 Locate the **Selections of Resulting Entities** section. Select the **Resulting objects selection** checkbox.

Form Union (fin)

In the **Geometry** toolbar, click  **Build All**.