



Model created in COMSOL Multiphysics 6.4

Orange Battery

Introduction

This tutorial model serves as an introduction to electrochemistry modeling in COMSOL Multiphysics. The example simulates the currents and the concentration of dissolved metal ions in a battery (corrosion cell) made from an orange and two metal nails.

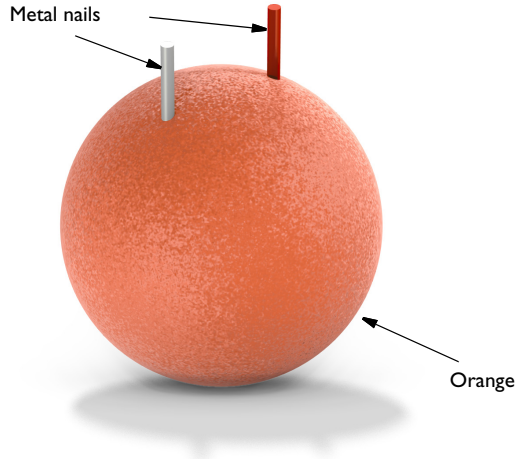

Figure 1: Modeled geometry. Orange and two metal nails. (Due to the high conductivity of the metal nails, only the orange pulp is included in the computational domain.)

This type of battery is commonly used in chemistry class demonstrations. Instead of an orange, lemons or potatoes can also be used.

Model Definition

The citric acid and various other ions in the orange serves as electrolyte, and using nails of different metals as electrodes creates a galvanic potential over the cell.

In this example, a zinc nail is used as one of the electrodes, giving rise to the following electrode reaction:

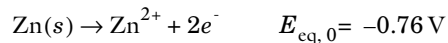

The other nail consists of copper, and here hydrogen evolution is assumed to take place:

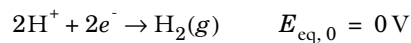

$E_{\text{eq},0}$ above denotes the equilibrium potentials at standard conditions versus a standard hydrogen electrode (SHE). In the model, the equilibrium potentials are corrected for the pH and zinc concentration of the orange pulp using the Nernst equation.

The model for the currents in the orange and electrodes is set up using the Secondary Current Distribution interface. The electrolyte current in the orange is thereby solved for by Ohm's law. The conductivity of the metal nails is so high that the electrode domains are not included in the model, instead boundary conditions on the nail surfaces are used to set the nail potentials. One nail is grounded, and the other one is set to a cell voltage to comply with a total current condition. This would correspond to a situation where the cell is controlled galvanostatically, for instance, by the use of a potentiostat.

Butler–Volmer type expressions, with concentration-dependent exchange current density for the zinc reaction, are used for the electrode kinetics on the surface of the nails within the orange.

The initial values electrolyte potential is set to correspond to the potential of a cell at open circuit (that is, no activation potential). Following the definition of the overpotential:

$$\eta = \phi_s - \phi_l - E_{\text{eq}}$$

the initial value becomes:

$$\phi_{l, \text{init}} = \phi_s - E_{\text{eq}} - \eta = 0 - E_{\text{eq}, \text{Zn}} - 0 = -E_{\text{eq}, \text{Zn}}$$

In an extension of the model, the transport of the dissolved zinc ions in the orange from the zinc electrode reaction is modeled by the Transport of Diluted Species interface in a time-dependent simulation. This assumes that the zinc ion transport can be described by diffusion according for Fick's law. In addition, the zinc electrode kinetics are modified to be dependent on the zinc concentration, which increases in the orange as more and more zinc is dissolved.

The cell current is set to a constant value of 1 mA, and the zinc concentration is set to 0.001 mol/m³ at the start of the simulation. All boundaries except the zinc electrode are insulated.

Results and Discussion

Figure 2 shows the potential field in the orange. The potential decreases as the current flows from the zinc electrode (left) to the upper electrode (right). The main part of the cell voltage loss is due to ohmic losses in the electrolyte.

The performance of the battery could probably be increased by using an electrolyte of higher conductivity (for example, a lemon instead of an orange) or by decreasing the distance between the nails.

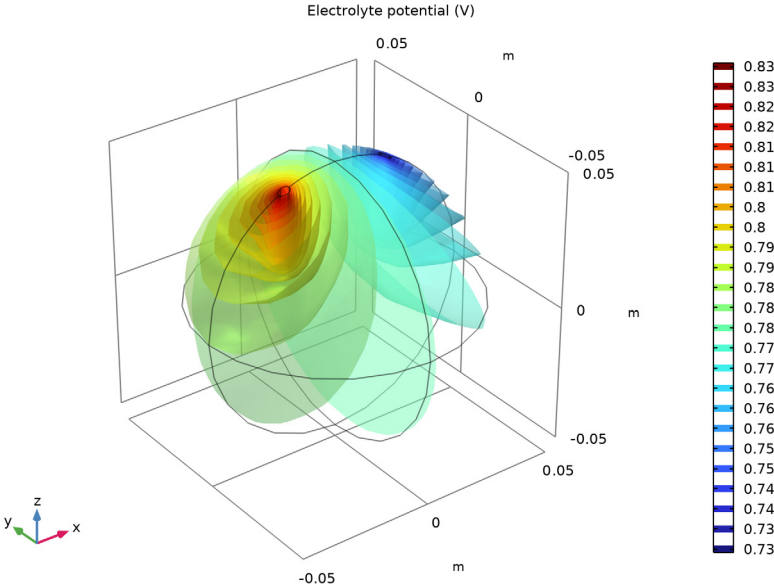

Figure 2: Potential field in the electrolyte at $t = 0$.

Figure 3 shows a polarization plot as the total current of the battery increases from 0 to 1 mA. The large change in cell voltage seen at low currents is due to overpotential losses at the zinc electrode. Increasing the area of the zinc electrode would decrease this effect.

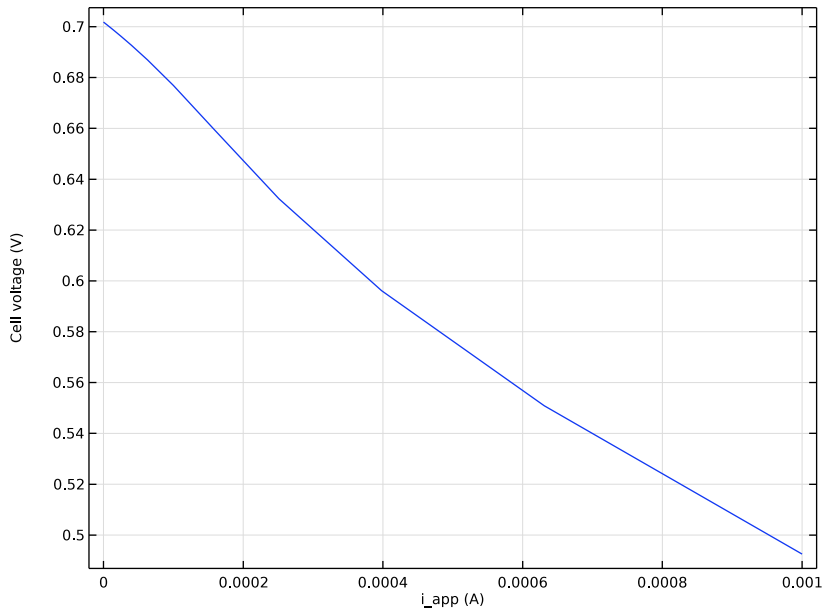

Figure 3: Polarization plot for the initial concentrations.

Figure 4 shows an isosurface for the 0.2 mol/m^3 concentration level of zinc ions after running the battery for five minutes. Figure 5 shows how far the 0.2 mol/m^3 isosurface level has reached after one hour.

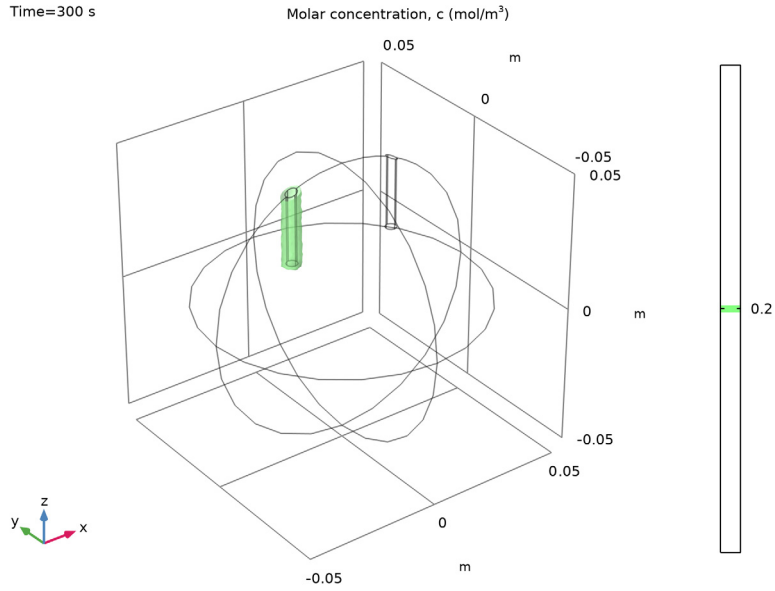

Figure 4: 0.2 mol/m^3 zinc concentration isosurface after five minutes.

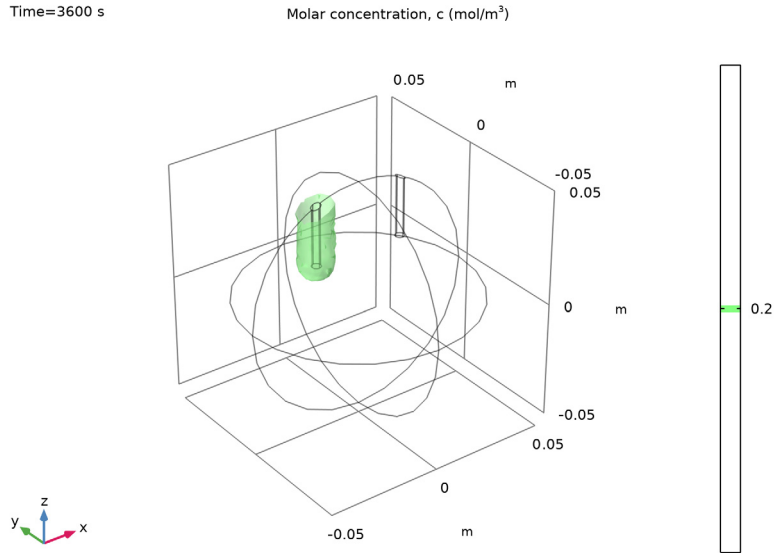

Figure 5: 0.2 mol/m³ zinc concentration isosurface after one hour.

Figure 6 shows how the cell voltage evolves with time. Due to the increase of zinc ions at the zinc nail electrode, the battery voltage decreases for a constant current.

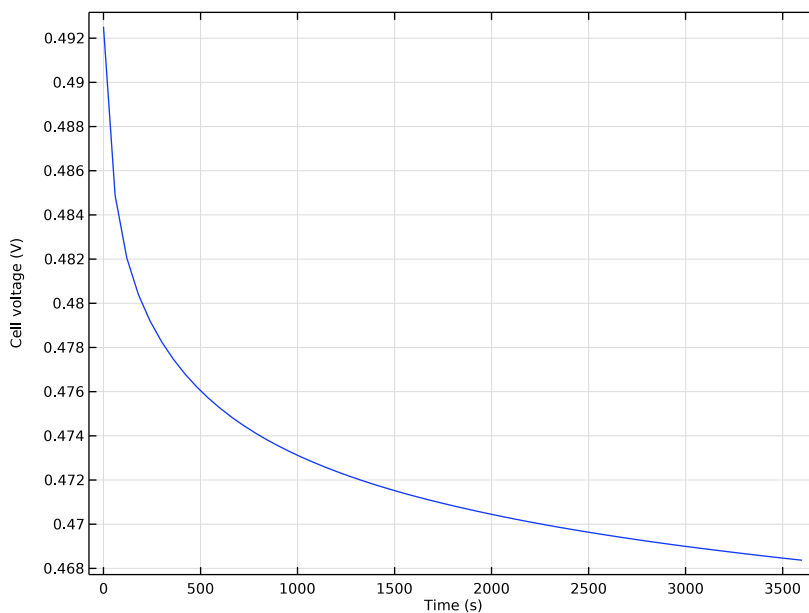

Figure 6: Cell voltage versus time.

Suggested Exercises and Extensions of the Model

Change the radius of the nails, and the value of the electrolyte conductivity, and investigate how this affects the polarization plot.

The proton concentration is not included in the model. Add the proton concentration under Dependent Variables on the Transport of Diluted Species node and couple the flux of protons on the copper surface by using an Electrode Surface Coupling node. In this manner, the change in pH of the cell can be monitored.

The dissolved zinc ions may form a layer of zinc hydroxide on the zinc surface, giving rise to an additional potential drop. You can use the Film Resistance section on the Electrode Surface node to include this potential drop. The value of the film resistance could, for instance, be a function of the zinc ion concentration variable in the pulp. Alternatively, you can add a Surface Reactions interface to model the buildup of the surface concentration of zinc hydroxide.

Application Library path: Electrodeposition_Module/
General_Electrochemistry/orange_battery



Modeling Instructions

From the **File** menu, choose **New**.

NEW

In the **New** window, click  **Model Wizard**.

MODEL WIZARD

- 1 In the **Model Wizard** window, click  **3D**.
- 2 In the **Select Physics** tree, select **Electrochemistry** > **Primary and Secondary Current Distribution** > **Secondary Current Distribution (cd)**.
- 3 Click **Add**.
- 4 Click  **Study**.
- 5 In the **Select Study** tree, select **General Studies** > **Stationary**.
- 6 Click  **Done**.

GEOMETRY I

Start by drawing the geometry; one sphere (the orange) and two cylinders (the metal nails).

Sphere 1 (sph1)

- 1 In the **Geometry** toolbar, click  **Sphere**.
- 2 In the **Settings** window for **Sphere**, locate the **Size** section.
- 3 In the **Radius** text field, type $5e-2$.

Zinc nail

- 1 In the **Geometry** toolbar, click  **Cylinder**.
- 2 In the **Settings** window for **Cylinder**, type Zinc nail in the **Label** text field.
- 3 Locate the **Size and Shape** section. In the **Radius** text field, type $2e-3$.
- 4 In the **Height** text field, type $5e-2$.
- 5 Locate the **Position** section. In the **x** text field, type $-2e-2$.

6 In the **z** text field, type $2e-2$.

By enabling **Resulting objects selection** you can easily select all boundaries of the nail later on when setting up the physics.

7 Locate the **Selections of Resulting Entities** section. Select the **Resulting objects selection** checkbox.

8 From the **Show in physics** list, choose **All levels**.

Copper nail

Duplicate the cylinder and change the x position to draw the second nail, as follows:

1 Right-click **Zinc nail** and choose **Duplicate**.

2 In the **Settings** window for **Cylinder**, type **Copper nail** in the **Label** text field.

3 Locate the **Position** section. In the **x** text field, type $2e-2$.

4 In the **Geometry** toolbar, click  **Build All**.

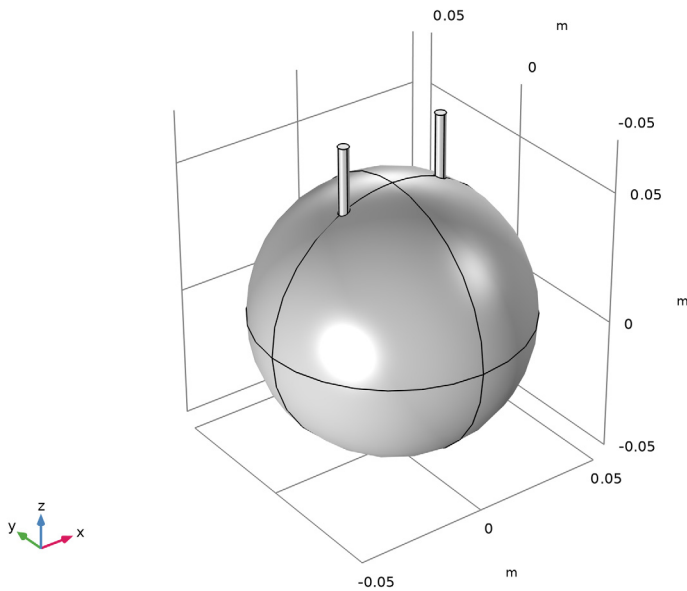

GLOBAL DEFINITIONS

Load some global parameters from a file. These will be used in multiple places in the model.

Parameters 1

- 1 In the **Model Builder** window, under **Global Definitions** click **Parameters 1**.
- 2 In the **Settings** window for **Parameters**, locate the **Parameters** section.
- 3 Click  **Load from File**.
- 4 Browse to the model's Application Libraries folder and double-click the file `orange_battery_parameters.txt`.

DEFINITIONS

Load also some variable definitions from a file.

Variables 1

- 1 In the **Model Builder** window, under **Component 1 (comp1)** right-click **Definitions** and choose **Variables**.
- 2 In the **Settings** window for **Variables**, locate the **Variables** section.
- 3 Click  **Load from File**.
- 4 Browse to the model's Application Libraries folder and double-click the file `orange_battery_variables.txt`.

SECONDARY CURRENT DISTRIBUTION (CD)

Now, start setting up the current distribution model.

Change the selection of the entire physics interface to the orange domain only.

- 1 In the **Model Builder** window, under **Component 1 (comp1)** click **Secondary Current Distribution (cd)**.
- 2 Select Domain 1 only.
Also create a selection for the orange domain. This will help if the geometry needs to be changed in the future. Selections is generally a convenient way to group different parts of the geometry together.
- 3 In the **Settings** window for **Secondary Current Distribution**, locate the **Domain Selection** section.
- 4 Click  **Create Selection**.
- 5 In the **Create Selection** dialog, type Orange in the **Selection name** text field.
- 6 Click **OK**.



Electrolyte 1

An Electrolyte node has already been added to the model by default. The selection is locked to all selected domains of the physics interface, which in this case is the orange only. Set the electrolyte conductivity.

- 1 In the **Model Builder** window, under **Component 1 (comp1) > Secondary Current Distribution (cd)** click **Electrolyte 1**.
- 2 In the **Settings** window for **Electrolyte**, locate the **Electrolyte** section.
- 3 From the σ_1 list, choose **User defined**. In the associated text field, type σ .

Electrode Surface 1

Use Electrode Surface nodes to define both a metal electrode potential and an electrode-electrolyte interface. Use a Butler-Volmer expression for the zinc electrode. The hydrogen kinetics are assumed to be very fast so that a linearized Butler-Volmer expression is applicable.

- 1 In the **Physics** toolbar, click  **Boundaries** and choose **Electrode Surface**.
- 2 In the **Settings** window for **Electrode Surface**, locate the **Boundary Selection** section.
- 3 From the **Selection** list, choose **Zinc nail**.
Enable transparency and inspect the active boundaries in the graphics window.
- 4 Click the  **Transparency** button in the **Graphics** toolbar.

Electrode Reaction 1

- 1 In the **Model Builder** window, click **Electrode Reaction 1**.
- 2 In the **Settings** window for **Electrode Reaction**, locate the **Equilibrium Potential** section.
- 3 From the E_{eq} list, choose **Nernst equation**.
- 4 In the $E_{\text{eq,ref}}(T)$ text field, type $E_{\text{eqref_Zn}}$.
- 5 In the C_{O} text field, type $c_{\text{Zn2}}/c_{\text{ref}}$.
- 6 Locate the **Stoichiometric Coefficients** section. In the n text field, type 2.
- 7 Locate the **Electrode Kinetics** section. From the **Kinetics expression type** list, choose **Butler–Volmer**.
- 8 From the **Exchange current density type** list, choose **From Nernst Equation**.
- 9 In the $i_{0,\text{ref}}(T)$ text field, type $i_{0\text{ref_Zn}}$.
- 10 In the α_{a} text field, type $\alpha_{\text{a_Zn}}$.

Electrode Surface 2

Now define the copper electrode in a similar way. First add a parameter for the total current. This parameter will also be used in the study to perform a galvanic polarization sweep over the cell.

- 1 In the **Physics** toolbar, click  **Boundaries** and choose **Electrode Surface**.
- 2 In the **Settings** window for **Electrode Surface**, locate the **Boundary Selection** section.
- 3 From the **Selection** list, choose **Copper nail**.
- 4 Locate the **Electrode Phase Potential Condition** section. From the **Electrode phase potential condition** list, choose **Total current**.
- 5 In the $I_{l,\text{total}}$ text field, type $-i_{\text{app}}$.

Electrode Reaction 1

- 1 In the **Model Builder** window, click **Electrode Reaction 1**.
- 2 In the **Settings** window for **Electrode Reaction**, locate the **Equilibrium Potential** section.
- 3 From the E_{eq} list, choose **Nernst equation**.
- 4 In the C_{O} text field, type $c_{\text{H0}}/c_{\text{ref}}$.
- 5 Locate the **Electrode Kinetics** section. In the i_0 text field, type $i0_{\text{H2}}$.

Initial Values 1

We are using nonlinear kinetics in the model. Provide an initial value for the electrolyte potential in order to reduce solver time and improve convergence. As a rule of thumb one can often use the negative of the equilibrium potential of the grounded electrode as initial value for the electrolyte potential.

- 1 In the **Model Builder** window, under **Component 1 (comp1) > Secondary Current Distribution (cd)** click **Initial Values 1**.
- 2 In the **Settings** window for **Initial Values**, locate the **Initial Values** section.
- 3 In the *phil* text field, type $-E_{\text{eq_Zn0}}$.

GLOBAL DEFINITIONS

Default Model Inputs

Set up the temperature value used in the entire model.

- 1 In the **Model Builder** window, under **Global Definitions** click **Default Model Inputs**.
- 2 In the **Settings** window for **Default Model Inputs**, locate the **Browse Model Inputs** section.
- 3 In the tree, select **General > Temperature (K) - minput.T**.

- 4 Find the **Expression for remaining selection** subsection. In the **Temperature** text field, type T.

MESH 1

- 1 In the **Model Builder** window, under **Component 1 (comp1)** click **Mesh 1**.
- 2 In the **Settings** window for **Mesh**, locate the **Physics-Controlled Mesh** section.
- 3 From the **Element size** list, choose **Coarse**.

STUDY 1

Since we are using the default mesh settings, the model is now ready for solving.

- 1 In the **Study** toolbar, click  **Compute**.

RESULTS

Electrolyte Potential (cd)

Plots of the electrolyte potentials are created by default.

Use an isosurface for visualizing the potential field in the electrolyte.

Potential Isosurface

- 1 In the **Results** toolbar, click  **3D Plot Group**.
- 2 In the **Settings** window for **3D Plot Group**, type Potential Isosurface in the **Label** text field.

Isosurface 1

- 1 Right-click **Potential Isosurface** and choose **Isosurface**.
- 2 In the **Settings** window for **Isosurface**, locate the **Levels** section.
- 3 In the **Total levels** text field, type 25.
- 4 Click the  **Zoom Extents** button in the **Graphics** toolbar.

5 In the **Potential Isosurface** toolbar, click  **Plot**.

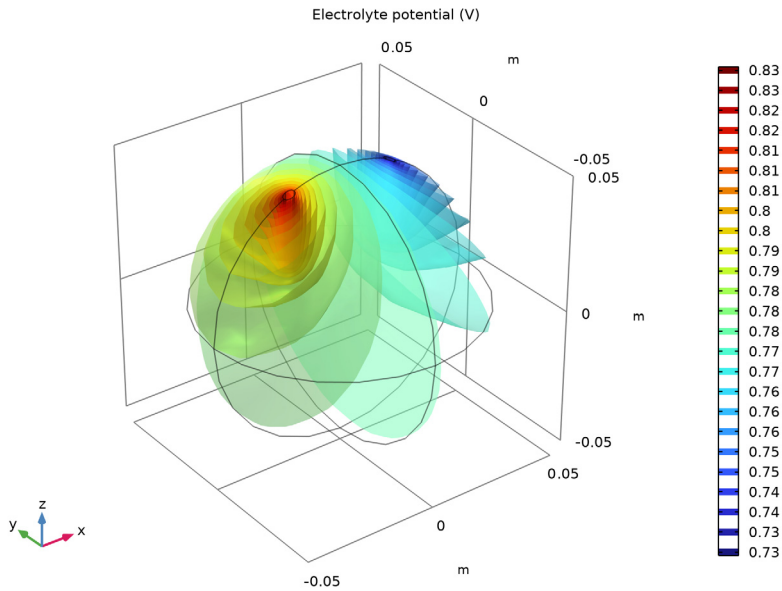

STUDY I

Step 1: Stationary

Now use an Auxiliary Sweep to solve over a range of cell currents in order to create a polarization plot.

- 1 In the **Model Builder** window, under **Study I** click **Step 1: Stationary**.
- 2 In the **Settings** window for **Stationary**, click to expand the **Study Extensions** section.
- 3 Select the **Auxiliary sweep** checkbox.
- 4 Click  **Add**.
- 5 In the table, enter the following settings:

Parameter name	Parameter value list	Parameter unit
i_{app} (Applied Current)	$0 \cdot 10^{\wedge} \text{range}(-5, 0.2, -3)$	A

6 In the **Study** toolbar, click  **Compute**.

RESULTS

Create a polarization plot as follows:

Polarization Plot

- 1 In the **Results** toolbar, click  **ID Plot Group**.
- 2 In the **Settings** window for **ID Plot Group**, type Polarization Plot in the **Label** text field.
- 3 Click to expand the **Title** section. From the **Title type** list, choose **None**.
- 4 Locate the **Plot Settings** section.
- 5 Select the **y-axis label** checkbox. In the associated text field, type Cell voltage (V).
- 6 Locate the **Legend** section. Clear the **Show legends** checkbox.

Global I

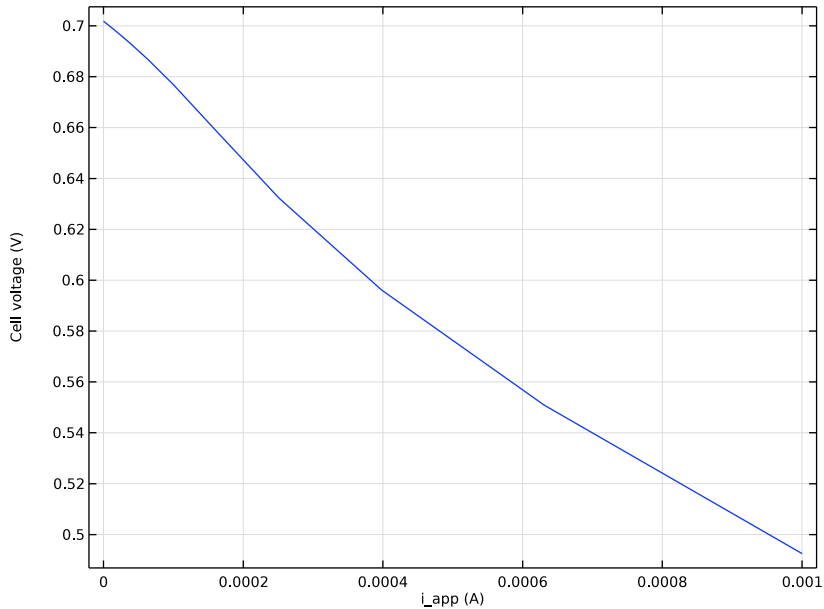

- 1 Right-click **Polarization Plot** and choose **Global**.
- 2 In the **Settings** window for **Global**, click **Replace Expression** in the upper-right corner of the **y-Axis Data** section. From the menu, choose **Component I (comp1) > Secondary Current Distribution > cd.phis_es2 - Electric potential - V**.
- 3 In the **Polarization Plot** toolbar, click  **Plot**.



COMPONENT I (COMP1)

Now, extend the model to investigate the battery voltage over time at a certain load current. Start by adding a physics interface to handle the mass transport of zinc ions.

ADD PHYSICS

- 1 In the **Home** toolbar, click  **Add Physics** to open the **Add Physics** window.
- 2 Go to the **Add Physics** window.
- 3 In the tree, select **Chemical Species Transport** > **Transport of Diluted Species (tds)**.
- 4 Click the **Add to Component 1** button in the window toolbar.
- 5 In the **Home** toolbar, click  **Add Physics** to close the **Add Physics** window.

TRANSPORT OF DILUTED SPECIES (TDS)

- 1 In the **Settings** window for **Transport of Diluted Species**, locate the **Domain Selection** section.
- 2 From the **Selection** list, choose **Orange**.

Because the orange pulp is stationary, convection does not need to be included in the model.
- 3 Locate the **Transport Mechanisms** section. Clear the **Convection** checkbox.

Due to the presence of a lot of other ions in the pulp, acting as supporting electrolyte, we assume the potential gradients to be small and hence also ignore the effect of migrative transport of the zinc ions.

Electrode Surface Coupling 1

For this example we will use the default diffusion coefficient value in the Transport Properties node so no settings are needed on the default domain node. The following steps couple the electrochemical reaction currents to the ion flux at the electrode surface:

- 1 In the **Physics** toolbar, click  **Boundaries** and choose **Electrode Surface Coupling**.
- 2 In the **Settings** window for **Electrode Surface Coupling**, locate the **Boundary Selection** section.
- 3 From the **Selection** list, choose **Zinc nail**.

Reaction Coefficients 1

- 1 In the **Model Builder** window, expand the **Electrode Surface Coupling 1** node, then click **Reaction Coefficients 1**.
- 2 In the **Settings** window for **Reaction Coefficients**, locate the **Reaction Current Density** section.
- 3 From the i_{loc} list, choose **Local current density, Electrode Reaction 1 (cd/es1/er1)**.
- 4 Locate the **Stoichiometric Coefficients** section. In the n text field, type 2.

5 In the v_c text field, type -1.

The stoichiometric number refers to the stoichiometry number of the reacting species when written as a reduction reaction.

Initial Values 1

Set the initial zinc ion concentration at the start of the time-dependent simulation.

- 1 In the **Model Builder** window, under **Component 1 (comp1) > Transport of Diluted Species (tds)** click **Initial Values 1**.
- 2 In the **Settings** window for **Initial Values**, locate the **Initial Values** section.
- 3 In the c text field, type c_{Zn20} .

DEFINITIONS

The zinc ion concentration is no longer constant. Modify the zinc ion concentration variable to be dependent on the local concentration. The name of this variable is c by default in the Transport of Diluted Species interface.

Variables 1



- 1 In the **Model Builder** window, under **Component 1 (comp1) > Definitions** click **Variables 1**.
- 2 In the **Settings** window for **Variables**, locate the **Variables** section.
- 3 In the table, enter the following settings:

Name	Expression	Unit	Description
c_{Zn2}	c	mol/m ³	Zinc ion concentration (used in above expressions)

ROOT

Create a new time-dependent study for the concentration simulation.

ADD STUDY

- 1 In the **Home** toolbar, click  **Add Study** to open the **Add Study** window.
- 2 Go to the **Add Study** window.
- 3 Find the **Studies** subsection. In the **Select Study** tree, select **Preset Studies for Selected Physics Interfaces > Secondary Current Distribution > Time Dependent with Initialization**.
- 4 Click the **Add Study** button in the window toolbar.
- 5 In the **Home** toolbar, click  **Add Study** to close the **Add Study** window.

STUDY 2

Step 1: Current Distribution Initialization

Use a secondary current distribution during the initialization step.

- 1 In the **Settings** window for **Current Distribution Initialization**, locate the **Study Settings** section.
- 2 From the **Current distribution type** list, choose **Secondary**.

Step 2: Time Dependent

- 1 In the **Model Builder** window, click **Step 2: Time Dependent**.
- 2 In the **Settings** window for **Time Dependent**, locate the **Study Settings** section.
- 3 In the **Output times** text field, type range (0, 60, 3600).
- 4 In the **Study** toolbar, click  **Compute**.

RESULTS

Cell Voltage vs. Time

A plot for how the cell voltage changes with time is created by default.

- 1 In the **Settings** window for **ID Plot Group**, type Cell Voltage vs. Time in the **Label** text field.
- 2 Locate the **Title** section. From the **Title type** list, choose **None**.
- 3 Locate the **Plot Settings** section.
- 4 Select the **y-axis label** checkbox. In the associated text field, type Cell voltage (V).
- 5 Locate the **Legend** section. Clear the **Show legends** checkbox.

6 In the **Cell Voltage vs. Time** toolbar, click  **Plot**.

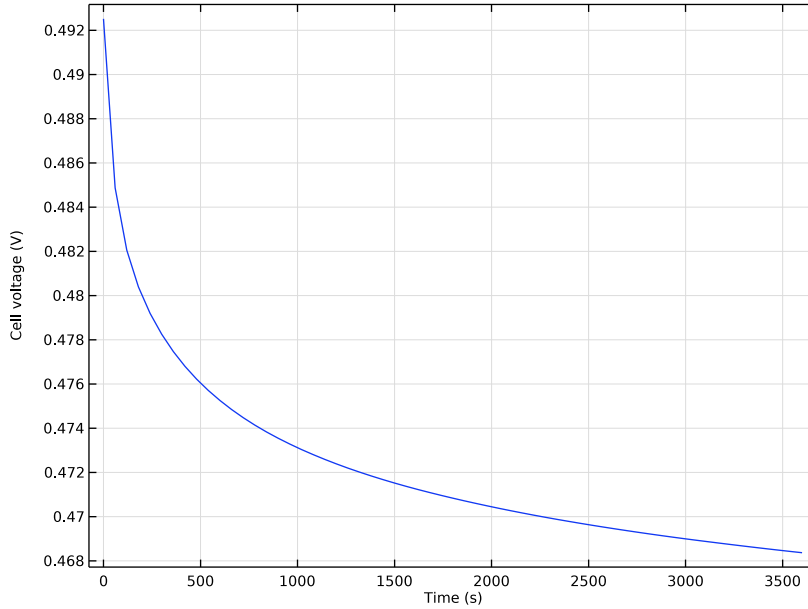

Plot the zinc concentration in the orange as follows:

Concentration Isosurface

- 1 In the **Results** toolbar, click  **3D Plot Group**.
- 2 In the **Settings** window for **3D Plot Group**, type **Concentration Isosurface** in the **Label** text field.
- 3 Locate the **Data** section. From the **Dataset** list, choose **Study 2/Solution 2 (sol2)**.
- 4 From the **Time (s)** list, choose **300**.

Isosurface 1

- 1 Right-click **Concentration Isosurface** and choose **Isosurface**.
- 2 In the **Settings** window for **Isosurface**, click **Replace Expression** in the upper-right corner of the **Expression** section. From the menu, choose **Component 1 (comp1) > Transport of Diluted Species > Species c > c - Molar concentration, c - mol/m³**.
- 3 Locate the **Levels** section. From the **Entry method** list, choose **Levels**.
- 4 In the **Levels** text field, type **0.2**.
- 5 Click the  **Zoom Extents** button in the **Graphics** toolbar.

6 In the **Concentration Isosurface** toolbar, click  **Plot**.

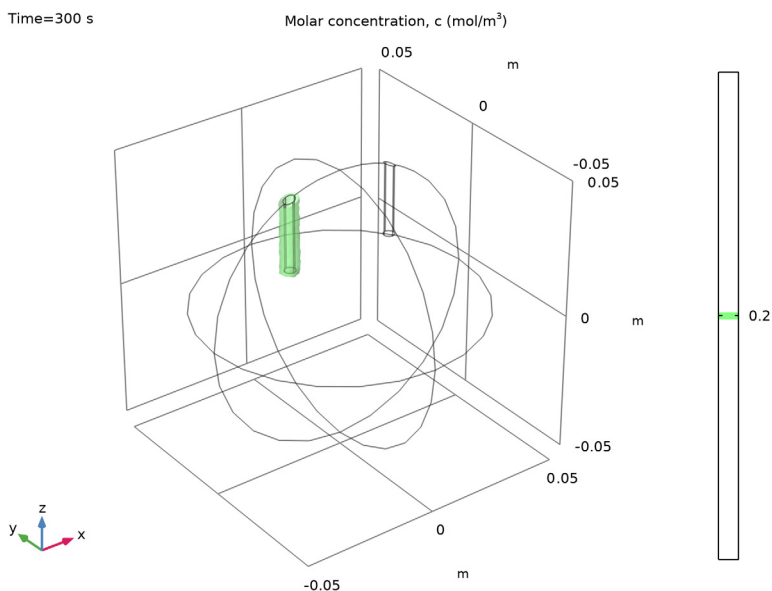

Animation 1

The following steps create an animation of the zinc ion isosurface during the simulated time:

1 In the **Results** toolbar, click  **Animation** and choose **Player**.

2 In the **Settings** window for **Animation**, locate the **Scene** section.

3 From the **Subject** list, choose **Concentration Isosurface**.

4 Locate the **Animation Editing** section. From the **Time selection** list, choose **From list**.

At $t = 0$ there is no concentration gradient in the orange. Therefore, clear the first time step.

5 In the **Times (s)** list, choose **60, 120, 180, 240, 300, 360, 420, 480, 540, 600, 660, 720, 780, 840, 900, 960, 1020, 1080, 1140, 1200, 1260, 1320, 1380, 1440, 1500, 1560, 1620, 1680, 1740, 1800, 1860, 1920, 1980, 2040, 2100, 2160, 2220, 2280, 2340, 2400, 2460, 2520, 2580, 2640, 2700, 2760, 2820, 2880, 2940, 3000, 3060, 3120, 3180, 3240, 3300, 3360, 3420, 3480, 3540, and 3600**.

6 Click the  **Zoom Extents** button in the **Graphics** toolbar.

22 Click the  **Play** button in the **Graphics** toolbar.

Time=3600 s

Molar concentration, c (mol/m³)

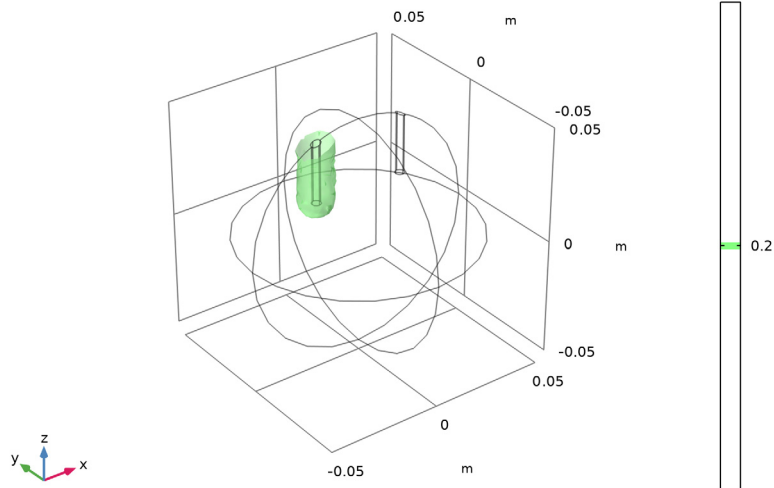

STUDY I

Step 1: Stationary

Note that if you want to experiment with the model by changing parameter values and simulate new polarization plots using the first (stationary) study, you have to disable the Transport of Diluted Species interface in that study as follows:

- 1 In the **Model Builder** window, under **Study I** click **Step 1: Stationary**.
- 2 In the **Settings** window for **Stationary**, locate the **Physics and Variables Selection** section.
- 3 In the **Solve for** column of the table, under **Component 1 (comp1)**, clear the checkbox for **Transport of Diluted Species (tds)**.

