



Model created in COMSOL Multiphysics 6.4

# Corrosion Protection of a Ship Hull



The zoomed-in model geometry highlighting the propeller features is shown [Figure 2](#) where the anode, shaft and propeller surfaces and the electrolyte domain are highlighted.

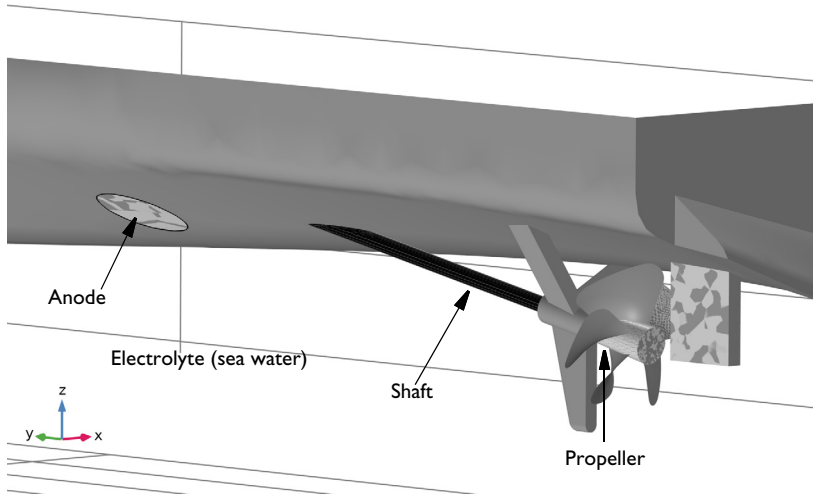

*Figure 2: The zoomed-in model geometry of the ship hull surface highlighting anode, shaft, propeller surfaces and electrolyte domain.*

Use the Secondary Current Distribution interface to solve for the electrolyte potential,  $\phi_l$  (SI unit: V), over the electrolyte domain according to:

$$\begin{aligned}\mathbf{i}_l &= -\sigma_l \nabla \phi_l \\ \nabla \cdot \mathbf{i}_l &= 0\end{aligned}$$

where  $\mathbf{i}_l$  (SI unit: A/m<sup>2</sup>) is the electrolyte current density vector and  $\sigma_l$  (SI unit: S/m) is the electrolyte conductivity of the sea water which is assumed to be a constant at 4 S/m.

Use the Electrode Surface boundary node at the shaft electrode surfaces to add electrode reactions and set the boundary condition for the electrolyte potential to

$$\mathbf{n} \cdot \mathbf{i}_l = i_{loc}$$

where  $i_{loc}$  (SI unit: A/m<sup>2</sup>) is the local individual electrode reaction current density.

The propeller and the shaft are considered to be made up of nickel aluminum bronze (NAB) alloy and Alloy 625, respectively.

Use the Electrode Surface boundary node at the shaft surface to add electrode reaction. The electrode kinetics at the shaft,  $i_{\text{kin}}$ , is set using the experimental polarization data for Alloy 625 which is available in corrosion material library (Ref. 2).

In case of uncoated propeller, use the Electrode Surface boundary node at the propeller base surfaces and use the Thin Electrode Surface boundary node at the propeller blades surfaces to add electrode reactions. Note that the Thin Electrode Surface boundary feature allows to prescribe the electrode kinetics at both the upside and downside of the propeller blades. The electrode kinetics at the propeller base and blades,  $i_{\text{kin}}$ , is set using the experimental polarization data for NAB alloy which is available in corrosion material library (Ref. 2).

The electrode reaction considered on the metal surfaces is oxygen reduction. Also enable a limiting current density of  $5 \text{ A/m}^2$  to the electrode kinetics expressions, since oxygen transport in the seawater is limited by the rate of transport to the surface. This will result in the following local current density expression

$$i_{\text{loc}} = \frac{i_{\text{lim}} i_{\text{kin}}}{i_{\text{lim}} + |i_{\text{kin}}|}$$

The ICCP system controls the hull potential versus the reference electrode. Describe this in the model by adding a Reference Electrode node, and then setting the electrode phase potential,  $\phi_{s,\text{ext}}$ , of the Electrode Surface nodes to  $-850 \text{ mV}$  versus the potential of the Reference Electrode.

Since the anode kinetics of this model is not known (and of minor interest for this analysis), use an Electrolyte Potential node for the anode surface and set the potential to  $0 \text{ V}$ . Note that the choice of potential level is at this boundary arbitrary and only serves to “bootstrap” (ground) the potentials of the model.

Use the default Insulation condition for all boundaries of the ship hull surfaces:

$$\mathbf{n} \cdot \mathbf{i}_t = 0$$

where  $\mathbf{n}$  is the normal vector, pointing out of the domain.

Use an Infinite Electrolyte condition on the external boundaries to the Electrolyte domain to describe the infinite extension of the ocean. Specify the ocean surface and mid ship plane as symmetry planes. This models the current conduction outside the drawn geometry, using the boundary element method.

The mesh used in the model is shown in [Figure 3](#), with a close-up of the propeller shown in [Figure 4](#).

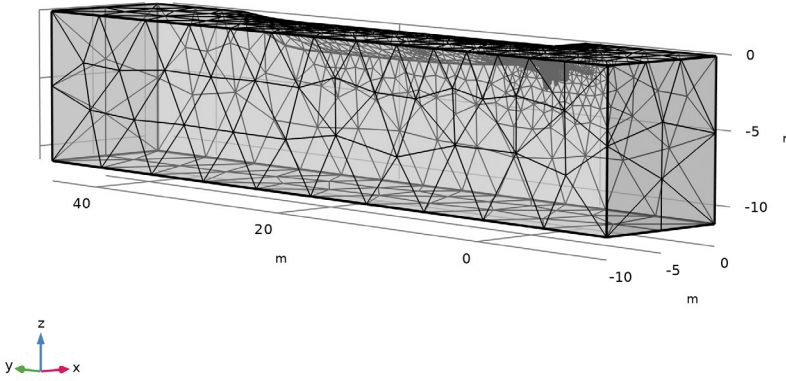

*Figure 3: The mesh used in model.*

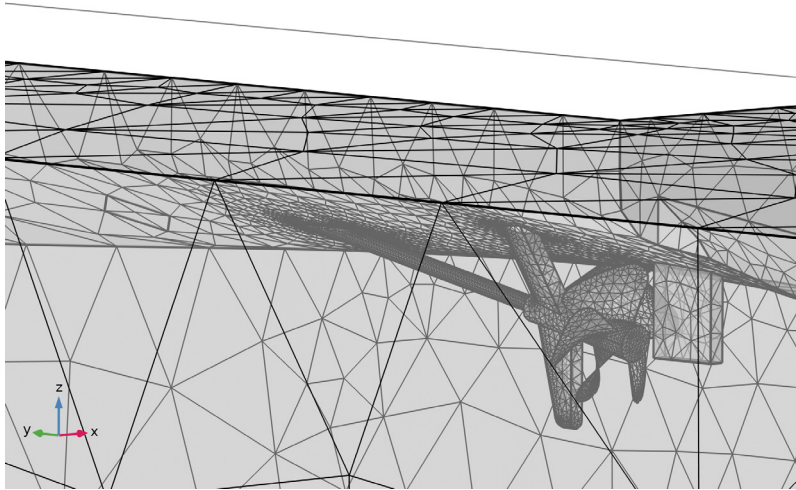

*Figure 4: The mesh used in model, zoomed in around propeller.*

### *Results and Discussion*

---

A surface plot of the hull potential for the case with a coated propeller is shown in [Figure 5](#). It can be seen that the potential distribution across the ship hull surface is quite uniform, except in the region close to the anode surface and the propeller and shaft surfaces. The

potential is higher near the shaft compared to the rest of the ship hull surface, indicating that this part of the hull is less protected compared to the other parts.

Streamline: Electrolyte current density vector Surface: Electrode potential with respect to adjacent reference (V) Surface Slit: Electrode potential with respect to adjacent reference (V) Electrode potential with respect to adjacent reference (V)

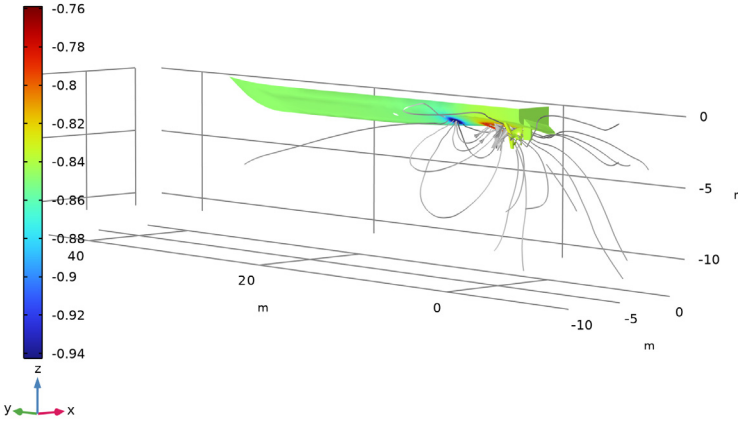

Figure 5: A surface plot of the hull potential for the case with a coated propeller.

Figure 6 shows a streamline plot of electrolyte current density and a surface plot of absolute value of the total current density over the shaft surface for the case with the coated

propeller. The ionic current flow from the anode surface to the shaft surface can be seen in Figure 6.

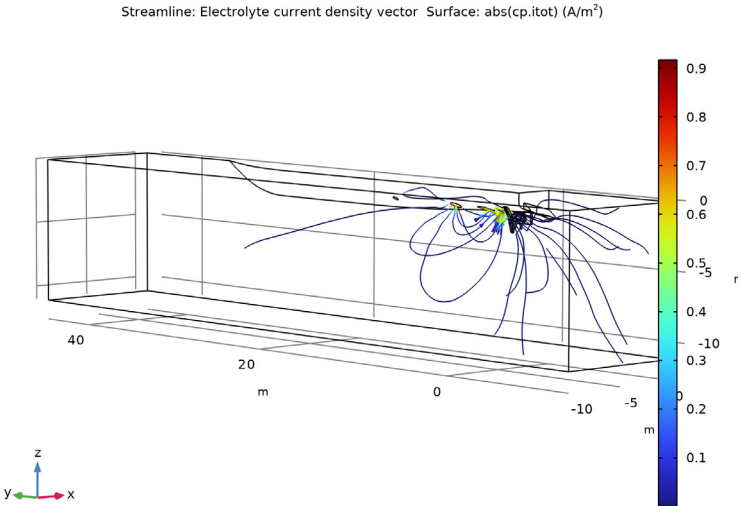

Figure 6: A surface plot of the total current density for the case with a coated propeller.

Figure 7 shows the potential for the case with an uncoated propeller. It can be seen that the potential distribution across the ship hull surface is less uniform compared to the coated propeller case.

Streamline: Electrolyte current density vector Surface: Electrode potential with respect to adjacent reference (V) Surface Silt: Electrode potential with respect to adjacent reference (V) Electrode potential with respect to adjacent reference (V)

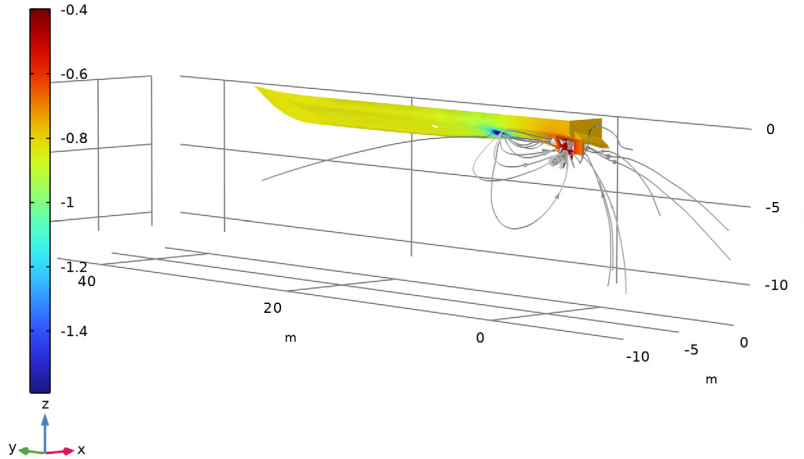
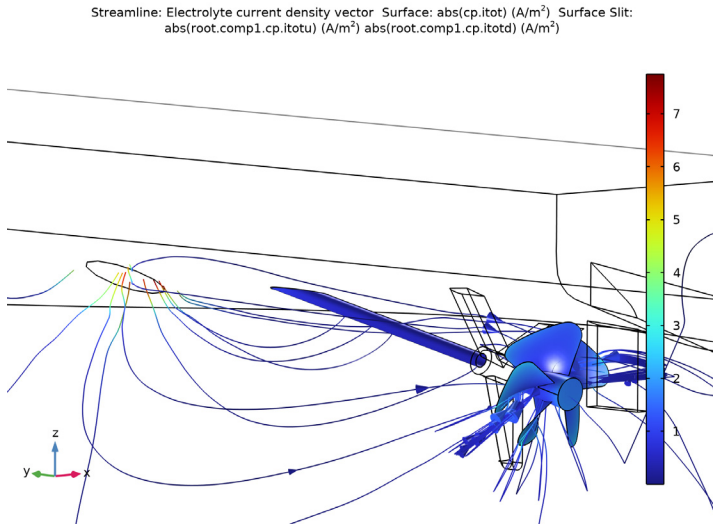

Figure 7: A surface plot of the hull potential for the case of an uncoated propeller.

A streamline plot of electrolyte current density and a surface plot of absolute value of the total current density over the shaft and propeller surfaces for the case of the uncoated propeller is shown in Figure 8. The ionic current flow from the anode surface to the shaft and propeller surfaces can be seen in Figure 8. The total current demand is found to be

higher in case of the uncoated propeller compared to the coated propeller case, which could be attributed to the higher cathode surface area in case of the uncoated propeller.



*Figure 8: A surface plot of the total current density for the case of an uncoated propeller.*

Figure 9 shows the electrode potential (vs an adjacent reference electrode) along the keel of the ship for both coated and uncoated propellers. It can be seen that, for the case of the uncoated propeller, the potential in the regions closer to the anode and the propeller surfaces deviates significantly from the rest of the ship hull surface. This deviation is less significant in the case of a coated propeller. Thus, the potential distribution across the length of ship hull surface is found to be considerably uniform in the case with the coated propeller, and more nonuniform for the uncoated propeller.

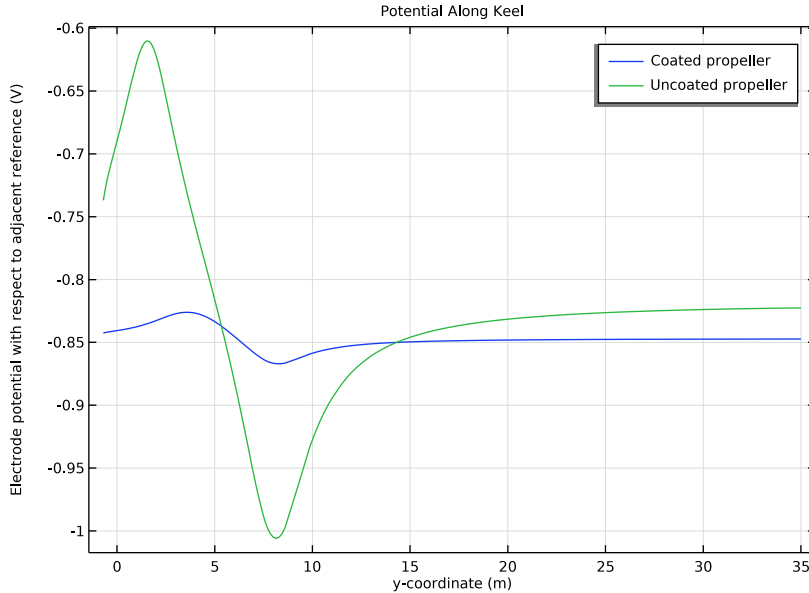

Figure 9: The electrode potential variation along the keel of the ship for both coated and uncoated propellers.

Finally, the integrated anode current is evaluated for the two cases. For the coated case the current is 0.84 A, and for the uncoated case the current is 6.5 A.

## References

1. T. Huber and Y. Wang, “Effect of propeller coating on cathodic protection current demand: Sea trial and modeling studies,” *Corrosion*, vol. 68, pp 441–448, 2012.
2. H.P. Hack, “Atlas of polarization diagrams for naval materials in seawater,” Naval Surface Warfare Centre Technical Report, CARDIVNSWC-TR-61-94/44, April 1995.

---

**Application Library path:** Corrosion\_Module/Cathodic\_Protection/ship\_hull

---



## Modeling Instructions

From the **File** menu, choose **New**.

## NEW

In the **New** window, click  **Model Wizard**.

## MODEL WIZARD

- 1 In the **Model Wizard** window, click  **3D**.
- 2 In the **Select Physics** tree, select **Electrochemistry > Cathodic Protection (cp)**.
- 3 Click **Add**.
- 4 Click  **Study**.
- 5 In the **Select Study** tree, select **General Studies > Stationary**.
- 6 Click  **Done**.

## GEOMETRY I



Import the geometry of the ship hull from a geometry file.

### *Import I (impl)*

- 1 In the **Geometry** toolbar, click  **Import**.
- 2 In the **Settings** window for **Import**, locate the **Source** section.
- 3 Click  **Browse**.
- 4 Browse to the model's Application Libraries folder and double-click the file `ship_hull_geometry.mphbin`.
- 5 Click  **Import**.

### *Mesh Control Faces I (mcfI)*

The geometry is divided into two domains, use a mesh control face to remove this split when setting up the physics. This will reduce the number of geometry entities that can be selected when setting up the physics.

- 1 In the **Geometry** toolbar, click  **Virtual Operations** and choose **Mesh Control Faces**.
- 2 On the object **fin**, select Boundaries 8–11 and 14 only.  
It might be easier to select the boundaries by using the **Selection List** window. To open this window, in the **Home** toolbar click **Windows** and choose **Selection List**. (If you are running the cross-platform desktop, you find **Windows** in the main menu.)
- 3 In the **Geometry** toolbar, click  **Build All**.

- 4 Click the  **Zoom Extents** button in the **Graphics** toolbar.

The geometry should now look like [Figure 1](#).

Click **Zoom Box** and zoom in on a region closer to the propeller. The zoomed-in geometry should now look like [Figure 2](#).

Disable the analysis of the geometry as the remaining small geometric details can be kept.

- 5 In the **Model Builder** window, click **Geometry I**.
- 6 In the **Settings** window for **Geometry**, locate the **Cleanup** section.
- 7 Clear the **Automatic detection of small details** checkbox.

## GLOBAL DEFINITIONS

Load the model parameters.



### *Parameters I*

- 1 In the **Model Builder** window, under **Global Definitions** click **Parameters I**.
- 2 In the **Settings** window for **Parameters**, locate the **Parameters** section.
- 3 Click  **Load from File**.
- 4 Browse to the model's Application Libraries folder and double-click the file `ship_hull_parameters.txt`.



## DEFINITIONS

Create explicit selections for the propeller base, propeller blades, shaft, anode, reference electrode and hull surfaces. Then create a selection for the ship hull surface by using a union. The selections will be used later on when specifying the physics, setting up the mesh and when plotting and evaluating the results.



### *Propeller base*

- 1 In the **Definitions** toolbar, click  **Explicit**.
- 2 In the **Settings** window for **Explicit**, locate the **Input Entities** section.
- 3 From the **Geometric entity level** list, choose **Boundary**.
- 4 Click  **Paste Selection**.
- 5 In the **Paste Selection** dialog, type 20-22 in the **Selection** text field.
- 6 Click **OK**.
- 7 In the **Settings** window for **Explicit**, type Propeller base in the **Label** text field.



### *Propeller blades*

- 1 In the **Definitions** toolbar, click  **Explicit**.
- 2 In the **Settings** window for **Explicit**, locate the **Input Entities** section.
- 3 From the **Geometric entity level** list, choose **Boundary**.
- 4 Click  **Paste Selection**.
- 5 In the **Paste Selection** dialog, type 14, 16, 17, 40, 41 in the **Selection** text field.
- 6 Click **OK**.
- 7 In the **Settings** window for **Explicit**, type Propeller blades in the **Label** text field.



### *Shaft*

- 1 In the **Definitions** toolbar, click  **Explicit**.
- 2 In the **Settings** window for **Explicit**, locate the **Input Entities** section.
- 3 From the **Geometric entity level** list, choose **Boundary**.
- 4 Click  **Paste Selection**.
- 5 In the **Paste Selection** dialog, type 29, 39 in the **Selection** text field.
- 6 Click **OK**.
- 7 In the **Settings** window for **Explicit**, type Shaft in the **Label** text field.

### *Anode*



- 1 In the **Definitions** toolbar, click  **Explicit**.
- 2 In the **Settings** window for **Explicit**, locate the **Input Entities** section.
- 3 From the **Geometric entity level** list, choose **Boundary**.
- 4 Click  **Paste Selection**.
- 5 In the **Paste Selection** dialog, type 19 in the **Selection** text field.
- 6 Click **OK**.
- 7 In the **Settings** window for **Explicit**, type Anode in the **Label** text field.

### *Reference electrode*



- 1 In the **Definitions** toolbar, click  **Explicit**.
- 2 In the **Settings** window for **Explicit**, locate the **Input Entities** section.
- 3 From the **Geometric entity level** list, choose **Boundary**.
- 4 Click  **Paste Selection**.
- 5 In the **Paste Selection** dialog, type 18 in the **Selection** text field.
- 6 Click **OK**.

7 In the **Settings** window for **Explicit**, type Reference electrode in the **Label** text field.



#### *Hull surface*

- 1 In the **Definitions** toolbar, click  **Explicit**.
- 2 In the **Settings** window for **Explicit**, locate the **Input Entities** section.
- 3 From the **Geometric entity level** list, choose **Boundary**.
- 4 Click  **Paste Selection**.
- 5 In the **Paste Selection** dialog, type 6-13, 15, 20-28, 30-38, 42-47 in the **Selection** text field.
- 6 Click **OK**.
- 7 In the **Settings** window for **Explicit**, type Hull surface in the **Label** text field.

#### *Ship surface*

- 1 In the **Definitions** toolbar, click  **Union**.
- 2 In the **Settings** window for **Union**, locate the **Geometric Entity Level** section.
- 3 From the **Level** list, choose **Boundary**.
- 4 Locate the **Input Entities** section. Under **Selections to add**, click  **Add**.
- 5 In the **Add** dialog, in the **Selections to add** list, choose **Propeller blades**, **Shaft**, **Anode**, **Reference electrode**, and **Hull surface**.
- 6 Click **OK**.
- 7 In the **Settings** window for **Union**, type Ship surface in the **Label** text field.

#### *Propeller and Shaft*

- 1 In the **Definitions** toolbar, click  **Union**.
- 2 In the **Settings** window for **Union**, locate the **Geometric Entity Level** section.
- 3 From the **Level** list, choose **Boundary**.
- 4 Locate the **Input Entities** section. Under **Selections to add**, click  **Add**.
- 5 In the **Add** dialog, in the **Selections to add** list, choose **Propeller base**, **Propeller blades**, and **Shaft**.
- 6 Click **OK**.
- 7 In the **Settings** window for **Union**, type Propeller and Shaft in the **Label** text field.

#### *Propeller*

- 1 In the **Definitions** toolbar, click  **Union**.
- 2 In the **Settings** window for **Union**, locate the **Geometric Entity Level** section.
- 3 From the **Level** list, choose **Boundary**.

- 4 Locate the **Input Entities** section. Under **Selections to add**, click **+ Add**.
- 5 In the **Add** dialog, in the **Selections to add** list, choose **Propeller base** and **Propeller blades**.
- 6 Click **OK**.
- 7 In the **Settings** window for **Union**, type **Propeller** in the **Label** text field.

## MATERIALS

Use the Corrosion material library to set up the material properties for the electrode kinetics at the shaft and propeller electrode surfaces.

### ADD MATERIAL

- 1 In the **Materials** toolbar, click  **Add Material** to open the **Add Material** window.
- 2 Go to the **Add Material** window.
- 3 In the tree, select **Corrosion > Nickel Alloys > Alloy 625 in seawater at 30 C**.
- 4 Click the **Add to Component** button in the window toolbar.

## MATERIALS

*Alloy 625 in seawater at 30 C (mat1)*

- 1 In the **Settings** window for **Material**, locate the **Geometric Entity Selection** section.
- 2 From the **Geometric entity level** list, choose **Boundary**.
- 3 From the **Selection** list, choose **Shaft**.
- 4 In the **Model Builder** window, expand the **Alloy 625 in seawater at 30 C (mat1)** node.

*Interpolation I (iloc\_exp)*

- 1 In the **Model Builder** window, expand the **Component I (comp1) > Materials > Alloy 625 in seawater at 30 C (mat1) > Local current density (lcd)** node, then click **Interpolation I (iloc\_exp)**.

2 In the **Settings** window for **Interpolation**, click  **Plot**.

The function plot should look like this:

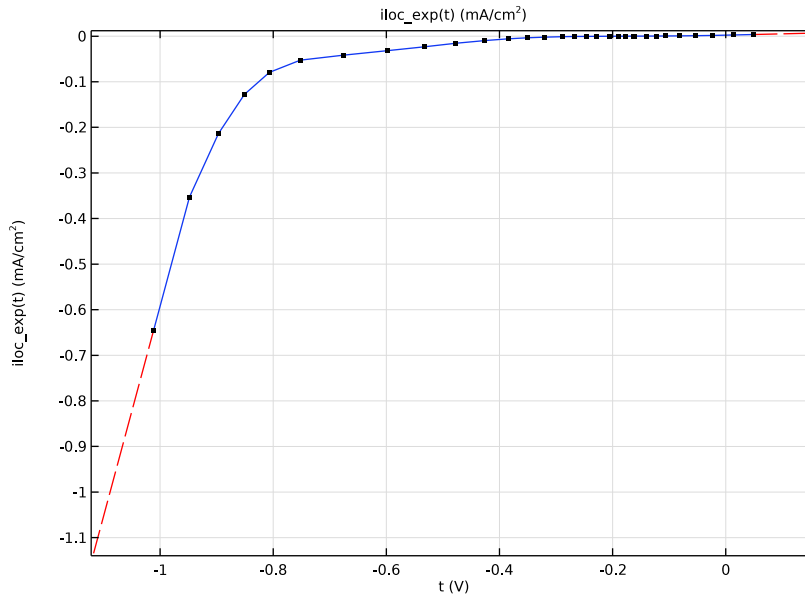

## ADD MATERIAL

- 1 Go to the **Add Material** window.
- 2 In the tree, select **Corrosion** > **Copper Alloys (Bronzes)** > **NAB in seawater at 30 C**.
- 3 Click the **Add to Component** button in the window toolbar.

## MATERIALS

*NAB in seawater at 30 C (mat2)*

- 1 In the **Settings** window for **Material**, locate the **Geometric Entity Selection** section.
- 2 From the **Geometric entity level** list, choose **Boundary**.
- 3 From the **Selection** list, choose **Propeller**.
- 4 In the **Model Builder** window, expand the **NAB in seawater at 30 C (mat2)** node.

*Interpolation 1 (iloc\_exp)*

- 1 In the **Model Builder** window, expand the **Component 1 (comp1)** > **Materials** > **NAB in seawater at 30 C (mat2)** > **Local current density (lcd)** node, then click **Interpolation 1 (iloc\_exp)**.

2 In the **Settings** window for **Interpolation**, click  **Plot**.

The function plot should look like this:

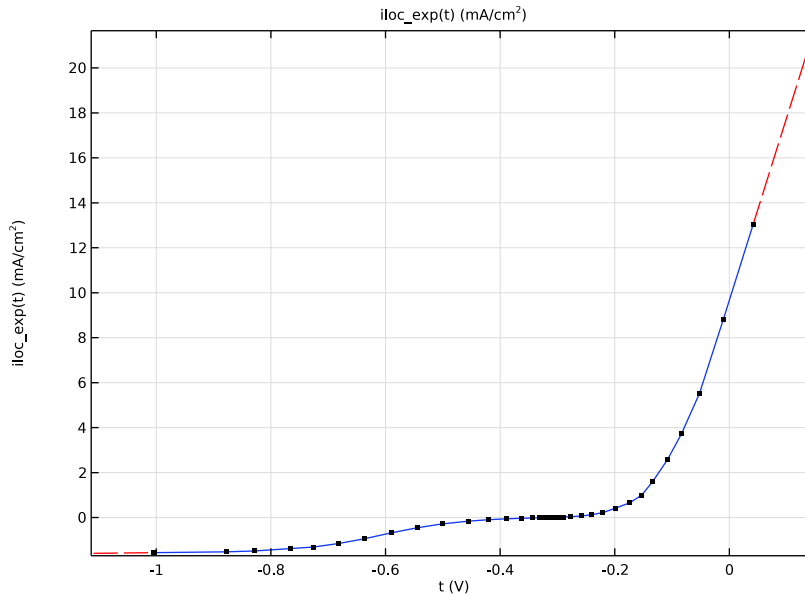

3 In the **Materials** toolbar, click  **Add Material** to close the **Add Material** window.

### CATHODIC PROTECTION (CP)

Now, set up the Cathodic Protection interface for the case of a coated propeller.

#### *Electrolyte 1*

Set up the user defined electrolyte conductivity.

1 In the **Settings** window for **Electrolyte**, locate the **Electrolyte** section.

2 From the  $\sigma_1$  list, choose **User defined**. In the associated text field, type `sigma`.

#### *Reference Electrode 1*

The ICCP system will control the potential of the ship hull versus a reference electrode, located at midship. In this model we set all Equilibrium potential with reference to Ag/AgCl. The equilibrium potential of this reference is hence 0.

1 In the **Physics** toolbar, click  **Points** and choose **Reference Electrode**.

2 Select Point 35 only.

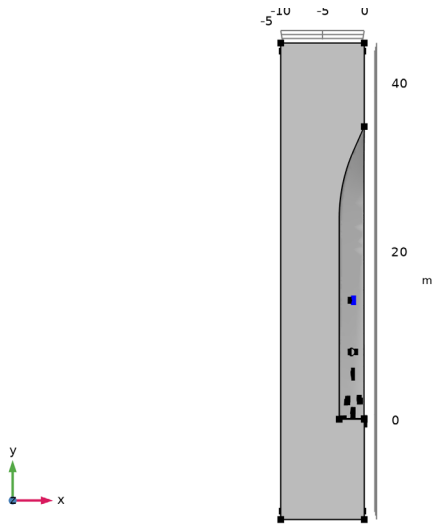

### *Impressed Current Surface 1*

In this model we will not explicitly define the anode reaction kinetics. Instead we will use a potential (primary) condition for the anode potential.

- 1 In the **Physics** toolbar, click  **Boundaries** and choose **Impressed Current Surface**.
- 2 In the **Settings** window for **Impressed Current Surface**, locate the **Boundary Selection** section.
- 3 From the **Selection** list, choose **Anode**.
- 4 Locate the **Impressed Current Surface** section. In the  $E_{\text{impr}}$  text field, type `E_control`.
- 5 From the  $\phi_{\text{s,ref}}$  list, choose **Electric reference potential (cp/refel1)**.

### *Electrode Surface 1*

Now specify the electrode potential and the kinetics for the shaft surface.

- 1 In the **Physics** toolbar, click  **Boundaries** and choose **Electrode Surface**.
- 2 In the **Settings** window for **Electrode Surface**, locate the **Boundary Selection** section.
- 3 From the **Selection** list, choose **Shaft**.

### *Electrode Reaction 1*

- 1 In the **Model Builder** window, click **Electrode Reaction 1**.
- 2 In the **Settings** window for **Electrode Reaction**, locate the **Electrode Kinetics** section.

- 3 From the  $i_{loc,expr}$  list, choose **From material**.
- 4 Select the **Limiting current density** checkbox.
- 5 In the  $i_{lim}$  text field, type `1lim`.

#### *Passive Metal Surface 1*

Next set the insulation condition for the ship surface.

- 1 In the **Physics** toolbar, click  **Boundaries** and choose **Passive Metal Surface**.
- 2 In the **Settings** window for **Passive Metal Surface**, locate the **Boundary Selection** section.
- 3 From the **Selection** list, choose **Hull surface**.

#### *Thin Passive Metal Surface 1*

Next set the insulation condition for the propeller blade surface.

- 1 In the **Physics** toolbar, click  **Boundaries** and choose **Thin Passive Metal Surface**.
- 2 In the **Settings** window for **Thin Passive Metal Surface**, locate the **Boundary Selection** section.
- 3 From the **Selection** list, choose **Propeller blades**.

Add an Infinite Electrolyte to describe an infinite extension of the electrolyte. Use symmetry planes to describe the ocean surface and the midship symmetry planes.

#### *Infinite Electrolyte 1*

- 1 In the **Physics** toolbar, click  **Boundaries** and choose **Infinite Electrolyte**.
- 2 Select Boundaries 1–3 and 5 only.
- 3 In the **Settings** window for **Infinite Electrolyte**, locate the **Electrolyte** section.
- 4 In the  $\sigma_1$  text field, type `sigma`.
- 5 Click to expand the **Symmetry Planes** section. Select the **yz-plane** checkbox.
- 6 Select the **xy-plane** checkbox.

No more boundary conditions are needed for study with the coated propeller since Insulation condition is applied by default, including the coated propeller surfaces.

#### *Initial Values 1*

Provide an initial value for the electrolyte potential to reduce the computational time.

- 1 In the **Model Builder** window, click **Initial Values 1**.
- 2 In the **Settings** window for **Initial Values**, locate the **Initial Values** section.
- 3 In the *phil* text field, type `0.5`.

## MESH 1

Build a mesh with a finer resolution at the propeller, shaft and hull surface. Mesh the domain around the propeller first.

### *Free Tetrahedral 1*

- 1 In the **Mesh** toolbar, click  **Free Tetrahedral**.
- 2 In the **Settings** window for **Free Tetrahedral**, locate the **Domain Selection** section.
- 3 From the **Geometric entity level** list, choose **Domain**.
- 4 Select Domain 2 only.

### *Size 1*

- 1 Right-click **Free Tetrahedral 1** and choose **Size**.
- 2 In the **Settings** window for **Size**, locate the **Element Size** section.
- 3 From the **Predefined** list, choose **Extra fine**.
- 4 Click the **Custom** button.
- 5 Locate the **Element Size Parameters** section.
- 6 Select the **Maximum element size** checkbox. In the associated text field, type 1.5.
- 7 Select the **Minimum element size** checkbox. In the associated text field, type 0.01.

### *Size 2*

- 1 In the **Model Builder** window, right-click **Free Tetrahedral 1** and choose **Size**.
- 2 In the **Settings** window for **Size**, locate the **Geometric Entity Selection** section.
- 3 From the **Geometric entity level** list, choose **Boundary**.
- 4 From the **Selection** list, choose **Propeller and Shaft**.
- 5 Locate the **Element Size** section. From the **Predefined** list, choose **Fine**.

### *Size 3*

- 1 Right-click **Free Tetrahedral 1** and choose **Size**.
- 2 In the **Settings** window for **Size**, locate the **Geometric Entity Selection** section.
- 3 From the **Geometric entity level** list, choose **Boundary**.
- 4 From the **Selection** list, choose **Propeller base**.
- 5 Locate the **Element Size** section. From the **Predefined** list, choose **Extra fine**.
- 6 Click  **Build Selected**.

### *Free Tetrahedral 2*

In the **Mesh** toolbar, click  **Free Tetrahedral**.

### Size 1

- 1 Right-click **Free Tetrahedral 2** and choose **Size**.
- 2 Right-click **Mesh 1** and choose **Build All**.
- 3 Click the  **Zoom Extents** button in the **Graphics** toolbar.

The mesh should look like [Figure 3](#) (you may want to toggle the transparency button in order to see the mesh better).

### STUDY : COATED PROPELLER

Now, solve the model for the coated propeller case.

- 1 In the **Model Builder** window, click **Study 1**.
- 2 In the **Settings** window for **Study**, type Study : Coated Propeller in the **Label** text field.
- 3 In the **Study** toolbar, click  **Compute**.

### RESULTS

Several plots are added by default. Now, add a surface plot for hull potential to the electrode potential versus adjacent reference plot.

#### *Electrode Potential with Respect to Adjacent Reference (cp)*

- 1 In the **Model Builder** window, under **Results** click **Electrode Potential with Respect to Adjacent Reference (cp)**.
- 2 In the **Settings** window for **3D Plot Group**, locate the **Plot Settings** section.
- 3 Clear the **Plot dataset edges** checkbox.
- 4 Locate the **Color Legend** section. From the **Position** list, choose **Left**.
- 5 In the **Electrode Potential with Respect to Adjacent Reference (cp)** toolbar, click  **Plot**.  
The surface plot of the potential for the ship surface with the coated propeller should look like [Figure 5](#).

### Surface 1

In the **Model Builder** window, expand the **Electrolyte Current Density (cp)** node, then click **Surface 1**.

#### *Selection 1*

- 1 In the **Electrolyte Current Density (cp)** toolbar, click  **Selection**.
- 2 In the **Settings** window for **Selection**, locate the **Selection** section.
- 3 From the **Selection** list, choose **Shaft**.

4 In the **Electrolyte Current Density (cp)** toolbar, click  **Plot**.

#### *Electrolyte Current Density (cp)*

Select **Zoom Box** and a region closer to propeller. The surface plot of the total current density for the zoomed in region near the coated propeller should look like [Figure 6](#).

### **CATHODIC PROTECTION (CP)**

Now, set up the problem for an uncoated propeller case by describing the electrode kinetics at the propeller base surfaces using the Electrode Surface boundary feature and at the propeller blade surfaces using the Thin Electrode Surface boundary feature.

#### *Electrode Surface 2*

- 1 In the **Physics** toolbar, click  **Boundaries** and choose **Electrode Surface**.
- 2 In the **Settings** window for **Electrode Surface**, locate the **Boundary Selection** section.
- 3 From the **Selection** list, choose **Propeller base**.

#### *Electrode Reaction 1*

- 1 In the **Model Builder** window, click **Electrode Reaction 1**.
- 2 In the **Settings** window for **Electrode Reaction**, locate the **Electrode Kinetics** section.
- 3 From the  $i_{loc,expr}$  list, choose **From material**.
- 4 Select the **Limiting current density** checkbox.
- 5 In the  $i_{lim}$  text field, type `i.lim`.

#### *Thin Electrode Surface 1*

- 1 In the **Physics** toolbar, click  **Boundaries** and choose **Thin Electrode Surface**.
- 2 In the **Settings** window for **Thin Electrode Surface**, locate the **Boundary Selection** section.
- 3 From the **Selection** list, choose **Propeller blades**.

#### *Electrode Reaction 1*

- 1 In the **Model Builder** window, click **Electrode Reaction 1**.
- 2 In the **Settings** window for **Electrode Reaction**, locate the **Electrode Kinetics** section.
- 3 From the  $i_{loc,expr}$  list, choose **From material**.
- 4 Select the **Limiting current density** checkbox.
- 5 In the  $i_{lim}$  text field, type `i.lim`.



## STUDY : COATED PROPELLER

Now, disable the Electrode Surface 2 and Thin Electrode Surface 1 boundary nodes in study for the coated propeller and add a new study to solve the model for the uncoated propeller case.

### Step 1: Stationary

- 1 In the **Model Builder** window, under **Study : Coated Propeller** click **Step 1: Stationary**.
- 2 In the **Settings** window for **Stationary**, locate the **Physics and Variables Selection** section.
- 3 Select the **Modify model configuration for study step** checkbox.
- 4 In the tree, select **Component 1 (comp1) > Cathodic Protection (cp) > Electrode Surface 2**.
- 5 Right-click and choose **Disable**.
- 6 In the tree, select **Component 1 (comp1) > Cathodic Protection (cp) > Thin Electrode Surface 1**.
- 7 Right-click and choose **Disable**.

## ADD STUDY

- 1 In the **Study** toolbar, click  **Add Study** to open the **Add Study** window.
- 2 Go to the **Add Study** window.
- 3 Find the **Studies** subsection. In the **Select Study** tree, select **General Studies > Stationary**.
- 4 Click the **Add Study** button in the window toolbar.
- 5 In the **Study** toolbar, click  **Add Study** to close the **Add Study** window.  
Click **Add Study** again to close the Add Study frame.

## STUDY : UNCOATED PROPELLER



- 1 In the **Settings** window for **Study**, type Study : Uncoated Propeller in the **Label** text field.
- 2 In the **Study** toolbar, click  **Compute**.

## RESULTS

Several plots are added by default for the uncoated propeller case. The surface plot of the total current density for the zoomed in region near the uncoated propeller should look like [Figure 8](#). Now, add a surface plot for hull potential to the electrode potential versus adjacent reference plot.

### Electrode Potential with Respect to Adjacent Reference (cp) 1

- 1 In the **Model Builder** window, under **Results** click **Electrode Potential with Respect to Adjacent Reference (cp) 1**.

- 2 In the **Settings** window for **3D Plot Group**, locate the **Plot Settings** section.
- 3 Clear the **Plot dataset edges** checkbox.
- 4 Locate the **Color Legend** section. From the **Position** list, choose **Left**.
- 5 Click the  **Zoom Extents** button in the **Graphics** toolbar.
- 6 In the **Electrode Potential with Respect to Adjacent Reference (cp) I** toolbar, click  **Plot**.

The surface plot of the potential for the ship surface with the uncoated propeller should look like [Figure 7](#).

#### *Potential Along Keel*

Now, create a Line Plot along the keel of the hull potential for both the coated and uncoated propeller cases.

- 1 In the **Home** toolbar, click  **Add Plot Group** and choose **ID Plot Group**.
- 2 In the **Settings** window for **ID Plot Group**, type Potential Along Keel in the **Label** text field.
- 3 Locate the **Data** section. From the **Dataset** list, choose **None**.

#### *Line Graph 1*

- 1 Right-click **Potential Along Keel** and choose **Line Graph**.
- 2 In the **Settings** window for **Line Graph**, locate the **Data** section.
- 3 From the **Dataset** list, choose **Study : Coated Propeller/Solution 1 (sol1)**.
- 4 Select Edges 118 and 119 only.
- 5 Click **Replace Expression** in the upper-right corner of the **y-Axis Data** section. From the menu, choose **Component 1 (comp1) > Cathodic Protection > cp.Evsref - Electrode potential with respect to adjacent reference - V**.
- 6 Locate the **x-Axis Data** section. From the **Parameter** list, choose **Expression**.
- 7 In the **Expression** text field, type *y*.
- 8 Click to expand the **Legends** section. Select the **Show legends** checkbox.
- 9 From the **Legends** list, choose **Manual**.
- 10 In the table, enter the following settings:

<b>Legends</b>
Coated propeller

#### *Line Graph 2*

- 1 Right-click **Line Graph 1** and choose **Duplicate**.

- 2 In the **Settings** window for **Line Graph**, locate the **Data** section.
- 3 From the **Dataset** list, choose **Study : Uncoated Propeller/Solution 2 (sol2)**.
- 4 Locate the **Legends** section. In the table, enter the following settings:

<b>Legends</b>
Uncoated propeller



#### *Potential Along Keel*

- 1 In the **Model Builder** window, click **Potential Along Keel**.
- 2 In the **Settings** window for **ID Plot Group**, click to expand the **Title** section.
- 3 From the **Title type** list, choose **Label**.
- 4 In the **Potential Along Keel** toolbar, click  **Plot**.

The potential comparison plot for the coated and uncoated propellers should look like [Figure 9](#).

#### *Global Evaluation 1*

Finally, evaluate the magnitude of the current imposed by the ICCP anode.

- 1 In the **Results** toolbar, click  **Global Evaluation**.
- 2 In the **Settings** window for **Global Evaluation**, click **Replace Expression** in the upper-right corner of the **Expressions** section. From the menu, choose **Component 1 (comp1) > Cathodic Protection > cp.ltot\_imprcs1 - Total impressed current - A**.
- 3 Click  **Evaluate**.

#### *Global Evaluation 2*

- 1 Right-click **Global Evaluation 1** and choose **Duplicate**.
- 2 In the **Settings** window for **Global Evaluation**, locate the **Data** section.
- 3 From the **Dataset** list, choose **Study : Uncoated Propeller/Solution 2 (sol2)**.
- 4 Click  **Evaluate**.