



Model created in COMSOL Multiphysics 6.4

# Steam Reformer

## *Introduction*

---

In fuel cell power generators, a steam reformer unit typically produces the hydrogen needed for the fuel cell stack. This example illustrates the modeling of such a steam reformer. The tightly coupled system of mass, energy, and momentum equations used to describe the steam reformer is readily set up using the predefined physics interfaces of the Chemical Reaction Engineering Module.

Depending on the downstream fuel cell type, the carbon monoxide that forms through the reverse water-gas shift (WGS) reaction may poison the fuel cell catalyst. Therefore, after setting up the model, changes are made to the setup to investigate how to decrease the amount of carbon monoxide formed. Three different setups are modeled:

- Countercurrent setup: The heating media flows in the opposite direction to the reactants in the porous bed with an inlet temperature of 900 K for the heating media.
- Cocurrent 900 K setup: The heating media flows in the same direction as the reactants in the bed with an inlet temperature of 900 K for the heating media.
- Cocurrent 1000 K setup: The heating media flows in the same direction as the reactants in the bed with an inlet temperature of 1000 K for the heating media.

## Model Definition

Figure 1 shows the geometry of the reformer. The reformation chemistry occurs in a porous catalytic bed where energy is supplied through heating tubes to drive the endothermic process. The reactor is enclosed in an insulating jacket.

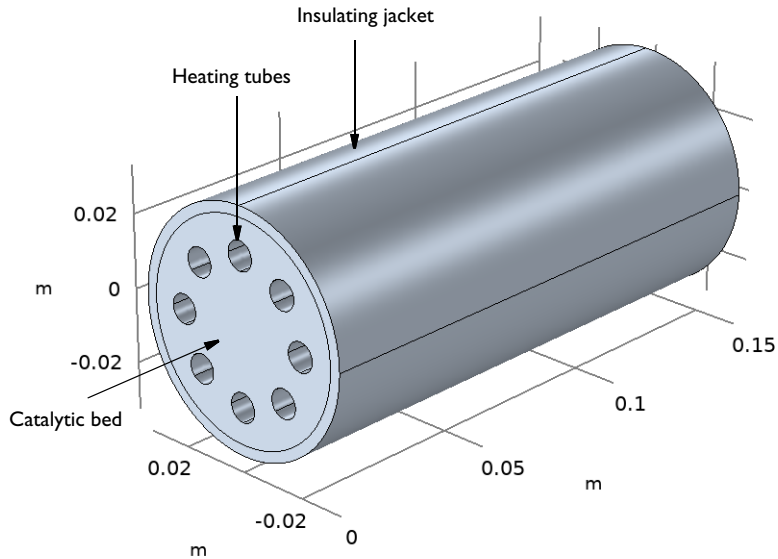
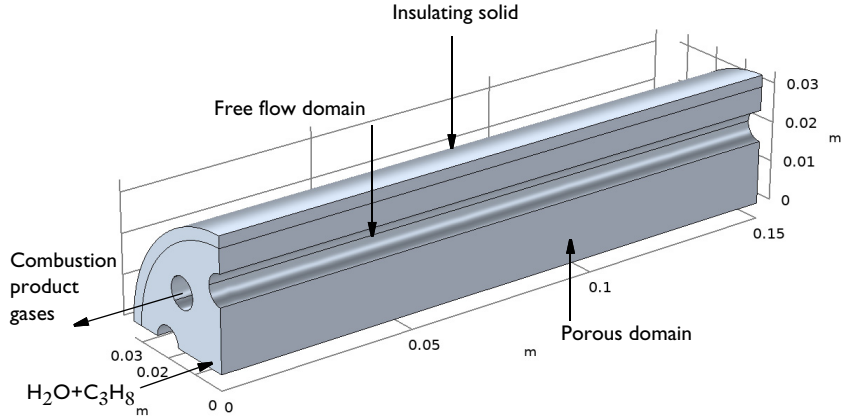

Figure 1: Geometry of the steam reformer unit.

In this example, propane and steam enters the reactor with a steam-to-carbon ratio of 3 mol  $\text{H}_2\text{O}$  per mol C. Operating with steam-to-carbon ratios between 2.5 and 4.5 mol/mol is common practice in industry to suppress carbon formation reactions (Ref. 2). Carbon formation is not included in this model, but an example of how to model this can be found in the model [Carbon Deposition in Heterogeneous Catalysis](#), also in the Chemical Reaction Engineering Module Application Library.

For heating purposes, hot gases from a burner are passed through a number of tubes perforating the reactor bed. The modeled domain can be reduced due to symmetry, see [Figure 2](#).



*Figure 2: Making use of symmetry, the modeling domain is reduced to a quarter of the full geometry.*

In the reformer, water and propane react to form hydrogen and carbon dioxide:



An overall kinetic model has been established from experiments ([Ref. 1](#)), where the reaction rate (SI unit:  $\text{mol}/(\text{m}^3 \cdot \text{s})$ ) has been found to be first order in the propane concentration:

$$r_1 = kc_{\text{C}_3\text{H}_8}$$

The rate constant follows Arrhenius equation, with the temperature dependence:

$$k = A \exp\left(-\frac{E_a}{R_g T}\right)$$

where the frequency factor  $A$  is  $7 \cdot 10^5 \text{ s}^{-1}$  and the activation energy  $E_a$  is 83.14 kJ/mol.

In the presence of hydrogen and carbon dioxide there is a probability to produce carbon monoxide through the reverse water gas shift reaction:



In this model, the reaction rate expression is described by the mass action law

$$r_2 = k_f c_{\text{CO}} c_{\text{H}_2\text{O}} - k_r c_{\text{CO}_2} c_{\text{H}_2} \quad (3)$$

where  $k_f$  and  $k_r$  are the forward and reverse rate constants, respectively. The forward rate constant is set up with an Arrhenius expression (parameters based on [Ref. 3](#)), while the reverse rate constant is defined using the concentration equilibrium constant  $K_c$

$$k_r = \frac{k_f}{K_c}$$

The water-gas shift reaction is mildly exothermic in its forward direction and the contribution from the reverse direction thus increases with temperature. Production of carbon monoxide is undesirable since hydrogen levels decrease, and carbon monoxide acts as a poison for the catalyst in the downstream fuel cell. Even low levels of carbon monoxide could be harmful for the downstream catalyst, and it is therefore important to include this reaction in the model.

#### FLUID FLOW — REFORMER BED

The flow of gaseous species through the reformer bed is described by Darcy's law:

$$\nabla \cdot \left( \rho \left( -\frac{\kappa}{\eta} \nabla p_{\text{sr}} \right) \right) = 0$$

Here,  $\rho$  denotes the gas density (SI unit:  $\text{kg}/\text{m}^3$ ),  $\eta$  the viscosity (SI unit:  $\text{Pa}\cdot\text{s}$ ),  $\kappa$  the permeability of the porous medium (SI unit:  $\text{m}^2$ ), and  $p_{\text{sr}}$  is the pressure in the reformer bed (SI unit:  $\text{Pa}$ ). The Darcy's law equation is, in this example, solved with the **Darcy's law** interface.

The inlet and outlet boundary conditions describe a 50 Pa pressure drop across the bed. All other boundaries are impervious, corresponding to the condition:

$$-\frac{\kappa}{\eta} \nabla p_{\text{sr}} \cdot \mathbf{n} = 0$$

#### ENERGY TRANSPORT — REFORMER BED

A one-equation approach is used to describe the average temperature distribution in the porous bed:

$$(\rho C_p)_{\text{eff}} \frac{\partial T_{\text{sr}}}{\partial t} + \nabla \cdot (-k_{\text{eff}} \nabla T_{\text{sr}}) + (\rho C_p)_f \mathbf{u} \cdot \nabla T_{\text{sr}} = \varepsilon Q$$

The effective thermal conductivity of the bed,  $k_{\text{eff}}$  (SI unit: W/(m·K)), is given by:

$$k_{\text{eff}} = \varepsilon k_f + (1 - \varepsilon) k_{\text{pm}}$$

In the above equations, the indices “f” and “pm” denote fluid and porous matrix, respectively, and  $\varepsilon$  is the volume fraction of the fluid phase. The effective volumetric heat capacity of the bed is given by:

$$(\rho C_p)_{\text{eff}} = \varepsilon (\rho C_p)_f + (1 - \varepsilon) (\rho C_p)_{\text{pm}}$$

Furthermore,  $T_{\text{sr}}$  (SI unit: K) is the temperature in the bed,  $Q$  (SI unit: W/m<sup>3</sup>) represents a heat source, and  $\mathbf{u}$  (SI unit: m/s) the fluid velocity. The equation is modeled using the **Heat Transfer in Porous Media** interface.

Assuming that the porous medium is homogeneous and isotropic, the steady-state equation becomes

$$\nabla \cdot (-k_{\text{sr}} \nabla T_{\text{sr}}) + (\rho C_p)_f \mathbf{u} \cdot \nabla T_{\text{sr}} = \varepsilon Q \quad (4)$$

The heat source  $Q$  (SI unit: J/(m<sup>3</sup>·s)) due to reaction is

$$Q = -\sum_j H_j r_j ,$$

where  $H_j$  (SI unit: J/(mol·K)) is the enthalpy of reaction for reaction  $j$ , and  $r_j$  is the reaction rate. Steam reformation of propane is endothermic, with an enthalpy of reaction of  $H = 410$  kJ/mol. The two enthalpy of reaction are derived automatically from **Thermodynamics**.

[Equation 4](#) also accounts for the conductive heat transfer in the insulating jacket. As no reactions occur in this domain, the description reduces to:

$$\nabla \cdot (-k_i \nabla T_{\text{sr}}) = 0$$

where  $k_i$  is the thermal conductivity (W/(m·K)) of the insulating material.

The temperature of the gas is 700 K at the inlet. At the outlet, it is assumed that convective heat transport is dominant:

$$\mathbf{n} \cdot (-k_{\text{sr}} \nabla T_{\text{sr}}) = 0$$

The heat exchange between the bed and the tubes is described by:

$$q = h_{ht}(T_{sr} - T) \quad (5)$$

where  $h_{ht}$  is the heat transfer coefficient (SI unit:  $W/(m^2 \cdot K)$ ) and  $T$  (SI unit: K) is the temperature of the heating tubes. A similar expression describes the heat flux from the insulating jacket to the surroundings:

$$q = -h_j(T_{sr} - T_{amb})$$

where  $h_j$  is the heat transfer coefficient of the jacket (SI unit:  $W/(m^2 \cdot K)$ ) and  $T_{amb}$  (SI unit: K) is the ambient temperature.

### MASS TRANSPORT — REFORMER BED

The **Transport of Concentrated Species** interface gives the equations for the mass transport. The mass-balance equations for the model are the Maxwell-Stefan diffusion and convection equations at steady state:

$$\nabla \cdot \left( \rho \omega_i \mathbf{u} - \rho \omega_i \sum_{k=1}^n \tilde{D}_{c,ik} \left( \nabla x_k + (x_k - \omega_k) \frac{\nabla p}{p} \right) - D_{c,i}^T \frac{\nabla T}{T} \right) = R_i$$

In the equations above,  $\rho$  denotes the density (SI unit:  $kg/m^3$ ),  $\omega_i$  is the mass fraction of species  $i$ ,  $x_k$  is the molar fraction of species  $k$ ,  $\tilde{D}_{c,ik}$  is the  $ik$  component of the effective multicomponent Fick diffusivity (SI unit:  $m^2/s$ ).  $D_{c,i}^T$  denotes the effective generalized thermal diffusion coefficient (SI unit:  $kg/(m \cdot s)$ ),  $T$  (SI unit: K) is the temperature, and  $R_i$  (SI unit:  $kg/(m^3 \cdot s)$ ) the reaction rate. The mass-balances are set up and solved with the Transport of Concentrated Species interface. The effective parameters accounts for the impact of porosity on the diffusivity, this model uses the Millington and Quirk model:

$$D_{c,ik} = \epsilon_p^{4/3} D_{ik}$$

$$D_{c,i}^T = \epsilon_p^{4/3} D_i^T$$

The inlet weight fraction of propane is 0.28. At the outlet, the convective flux condition is used:

$$\mathbf{n} \cdot \left( \left( -\rho \omega_i \sum_{j=1}^n \tilde{D}_{ij} \left( \nabla x_j + (x_j - \omega_j) \frac{\nabla p}{p} \right) \right) - D^T \frac{\nabla T}{T} \right) = 0$$

All other boundaries use the insulating or symmetry condition.

### FLUID FLOW — HEATING TUBES

The flow of heating gas in the tubes is described by the weakly compressible Navier-Stokes equations at steady-state:

$$\begin{aligned}\rho(\mathbf{u} \cdot \nabla)\mathbf{u} &= \nabla \cdot [-p\mathbf{I} + \mu(\nabla\mathbf{u} + (\nabla\mathbf{u})^T) - (2\mu/3)(\nabla \cdot \mathbf{u})\mathbf{I}] \\ \nabla \cdot (\rho\mathbf{u}) &= 0\end{aligned}$$

where  $\rho$  (SI unit:  $\text{kg}/\text{m}^3$ ) denotes density,  $\mathbf{u}$  (SI unit:  $\text{m}/\text{s}$ ) represents the velocity,  $\mu$  (SI unit:  $\text{kg}/(\text{m} \cdot \text{s})$ ) denotes dynamic viscosity, and  $p$  (SI unit: Pa) equals the pressure in the tubes.

The boundary conditions for the walls and outlet are

$$\begin{aligned}\mathbf{u} &= \mathbf{0} && \text{walls} \\ p &= p_{\text{ref}} && \text{outlet}\end{aligned}$$

At the outlet, viscous stresses are ignored and the pressure is set to the reference pressure. For the inlet boundary condition, fully developed flow is assumed and solved for using an average velocity.

The **Laminar Flow** interface sets up and solves the Navier-Stokes equations and is here used to model the gas flow in the tubes. Since the flow is nonisothermal, the **Heat Transfer in Fluids** interface is also used. These interfaces are coupled through the **Nonisothermal Flow** multiphysics coupling feature.

### ENERGY TRANSPORT — HEATING TUBES

The energy transport in heating tubes is described by:

$$\nabla \cdot (-k_{\text{ht}}\nabla T) + \rho C_p \mathbf{u} \cdot \nabla T = 0$$

where  $k_{\text{ht}}$  is the thermal conductivity (SI unit:  $\text{W}/(\text{m} \cdot \text{K})$ ) of the heating gas. The temperature of the gas is 900 K at the inlet. Also this energy transport is modeled with the Heat Transfer in Fluids interface.

At the outlet, it is assumed that convective heat transport is dominant:

$$\mathbf{n} \cdot (-k_{\text{ht}}\nabla T) = 0$$

The heat exchange between the bed and tubes is given by:

$$q = -h_{\text{ht}}(T_{\text{sr}} - T)$$

This is the same heat flux as given by Equation 5, but with reversed sign.

## Results and Discussion

Figure 3 shows the mass fraction of propane in the reformer bed in the countercurrent setup. The inlet mass fraction is 0.20 while the fraction at the outlet is close to zero.

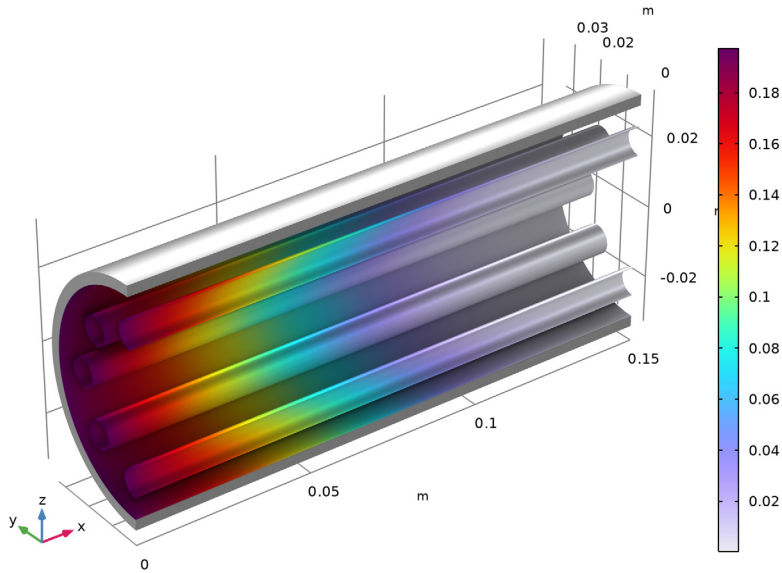

Figure 3: Mass fraction distribution of propane in the reformer bed. Counter current setup.

Figure 4, a cut plane plot of the countercurrent dataset, shows the mass fraction of propane in the bed, half way down the reactor length. The temperature in the cut plane is illustrated with contour lines. The mass fraction distribution in the cut plane is small and the heat supplied by the tubes is thus sufficient to make use of the entire catalytic volume.

Figure 4 confirms the picture in the previous surface plot, namely that about 75% of the propane has been reformed already half way through the reactor.

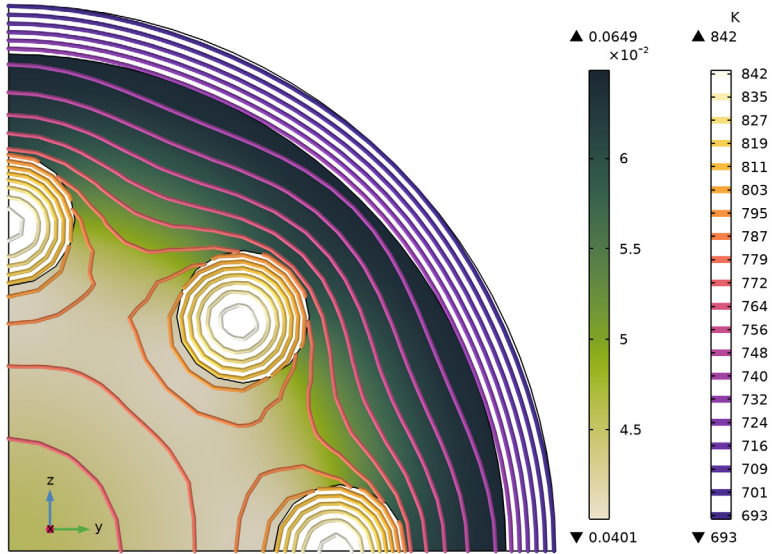

Figure 4: Mass fraction distribution of propane in a cut plane half way down the reactor length. Countercurrent setup.

Figure 5 shows the mass fractions of all reacting species in the bed, evaluated along the reactor centerline.

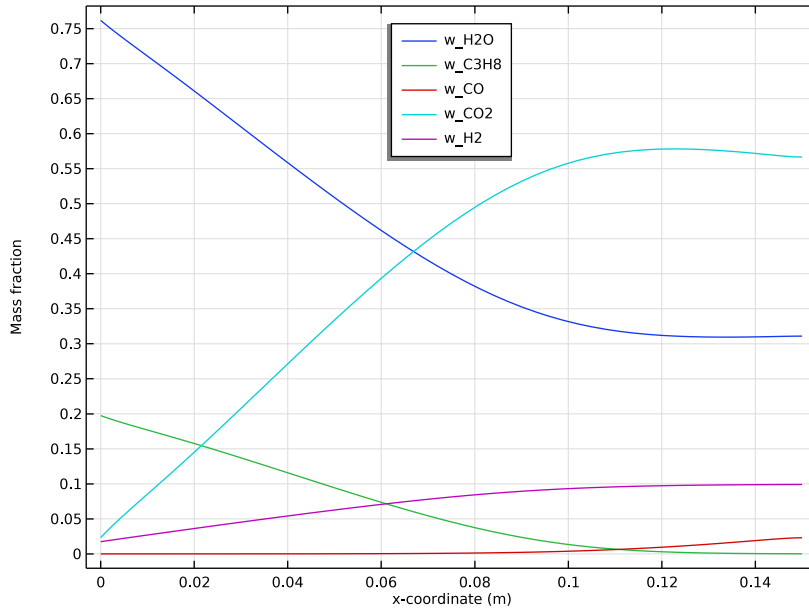

Figure 5: Mass fraction of reacting species as function of bed length, plotted along the reactor centerline. Countercurrent setup.

CO is formed as a result of the reverse water-gas shift reaction and at the exit of the bed the mass fraction of CO is a few percent. Depending on the downstream catalyst this may pose a problem. Therefore, two additional reformer setups are modeled to investigate how to decrease the amount of CO formed. The propane and carbon monoxide levels along the bed centerline for all three setups are shown in Figure 7. It is evident that a cocurrent setup, keeping the same inlet temperature for the heating media (900 K), decreases the amount of CO formed in the bed. This effect is mainly due to the lower conversion of propane, resulting in less carbon dioxide, but also an effect of the different temperature profiles in the compared setups. Increasing the heating media temperature to 1000 K in the cocurrent case increases the conversion of propane in the bed, and as a result, the amount of CO formed. Still, with this setup (cocurrent 1000 K) it is possible to decrease

the reactor length to 0.1 m while keeping the same level of conversion of propane but not increasing the amount of CO formed.

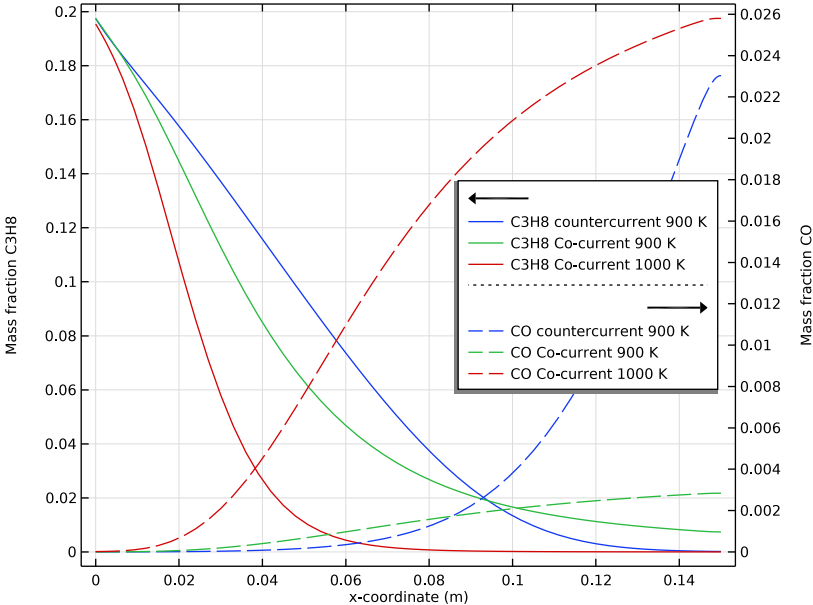

Figure 6: Mass fraction for propane and carbon monoxide along the bed centerline. Three different setups are shown (countercurrent 900 K, cocurrent 900 K, and cocurrent 1000 K).

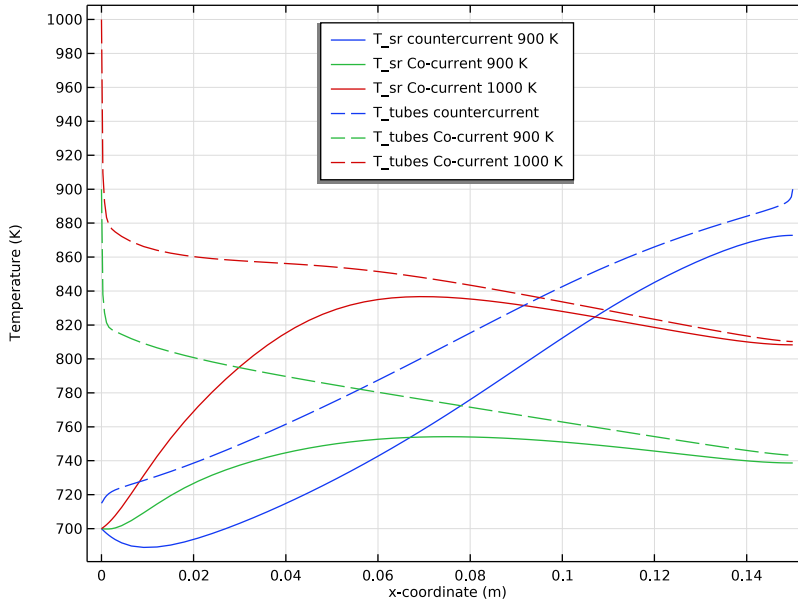
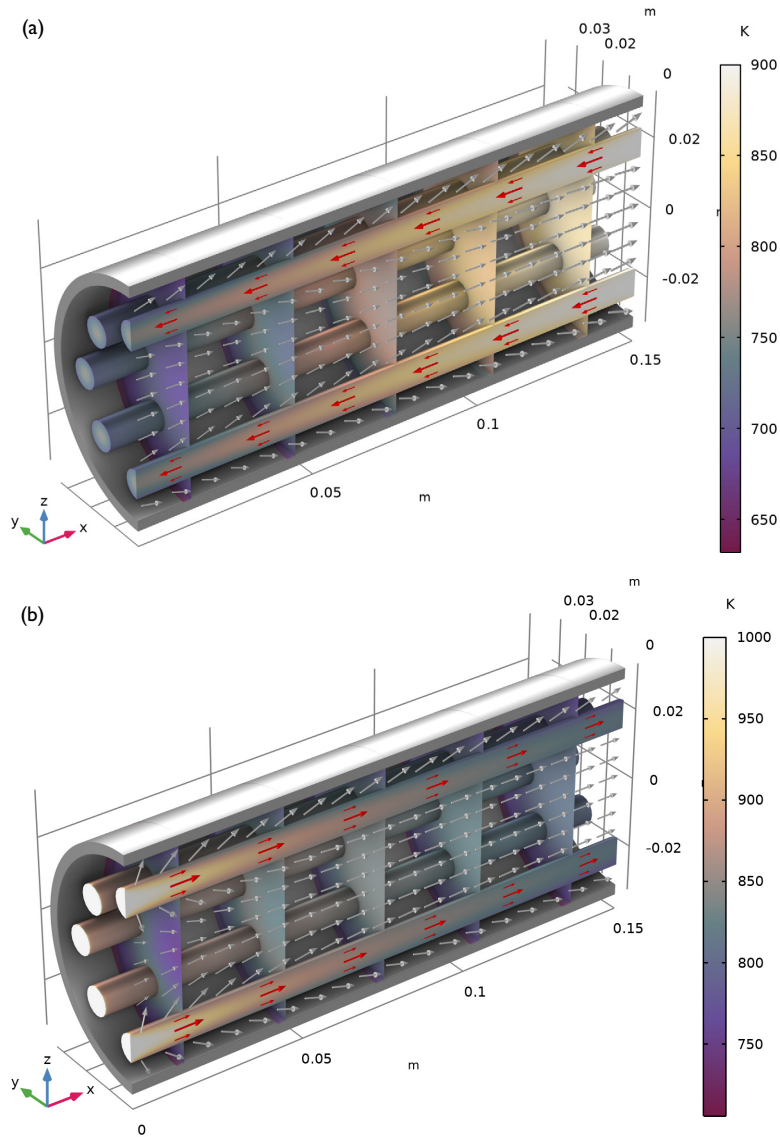

Figure 7: Reactor temperature as a function of position, plotted along the reactor centerline (solid lines) as well as along one of the tube walls (dashed lines).

Figure 7 shows the temperature along the centerline of the bed, as well as the temperature along one of the tube walls. The gas of the heating tubes enters at 900 K or 1000 K, depending on the setup, and exits at approximately 716 K, 740 K, and 810 K for the cases countercurrent, cocurrent 900 K, and cocurrent 1000 K, respectively. The gas temperature in the reformer bed is 700 K at the inlet for all three setups. For the countercurrent case, the temperature goes through a minimum (due to the endothermic steam reforming reaction), after which it increases and finally exits with an average temperature of 860 K (not shown in the plot). The average exit temperatures (not shown in plot) for the cocurrent cases are both lower than for the countercurrent case, which is beneficial for the forward water-gas shift reaction (decreases CO formation).



*Figure 8: Temperature distributions in the reformer system, including the reformer bed and insulating wall (slices), and heating tubes (surface). Arrows indicate total heat flux on part of the symmetry surface for the bed and heating tubes. (a) Countercurrent setup, (b) Cocurrent 1000 K setup.*

The energy exchange between the heating tubes and reformer bed is clearly illustrated in [Figure 8](#), showing both the countercurrent and the cocurrent setup (1000 K).

[Figure 9](#) shows, for the cocurrent 1000 K setup, the velocity fields of both the heating gas in the tubes and the reacting gas in the bed. The flow in the heating tubes is laminar and the parabolic velocity distribution is clearly seen. The gas velocity in the porous bed is relatively stable throughout the reactor. This is not the case for the countercurrent setup where the gas velocity in the bed increases much faster along the bed (not shown) due to the temperature increase down the reactor.

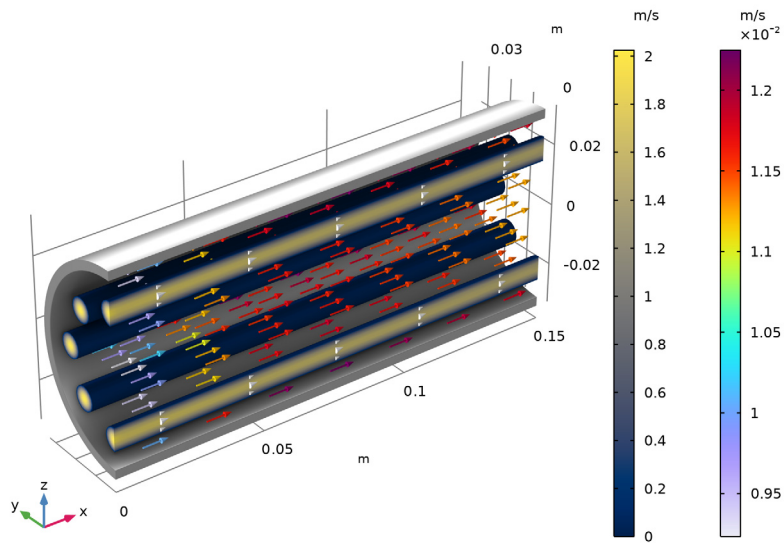

*Figure 9: Velocity fields of the heating tubes and the reformer bed. Cocurrent 1000 K setup.*

[Figure 10](#) illustrates, for the cocurrent 1000 K setup, the associated density variations in the reformer bed, accounting for both composition and temperature effects. The density variations are all present close to the bed inlet. As for the velocity, the density plot for the

countercurrent case is quite different, with a steady decrease in density along the bed length (not shown).

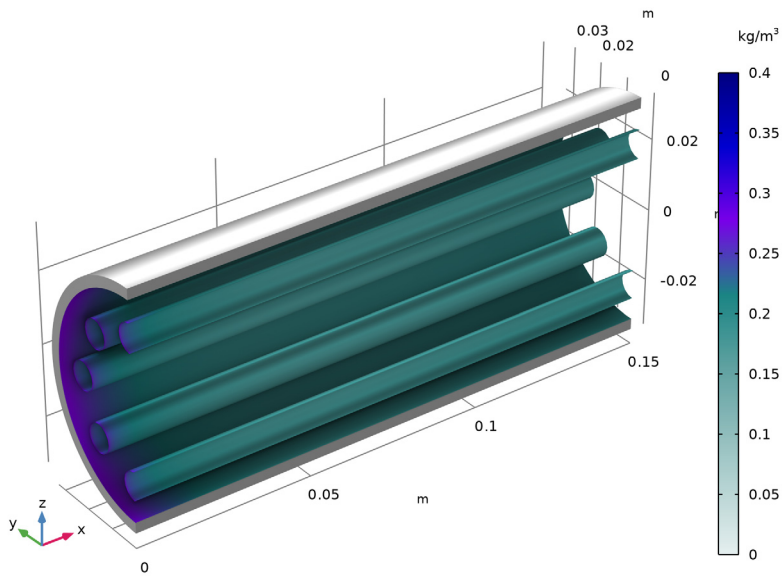

Figure 10: Overall gas density in the reformer bed. Cocurrent 1000 K setup.

In summary, this example illustrates the simulation of a reactor described by fully coupled mass, energy, and flow equations.

## Reference

1. P. Gateau, *Design of Reactors and Heat Exchange Systems to Optimize a Fuel Cell Reformer*, Proceedings of the COMSOL User's Conference Grenoble, 2007.
2. J.A. Moulijn, M. Makkee, and A.E. van Diepen, *Chemical Process Technology*, 1st edition, John Wiley & Sons, 2001.
3. C. Rhodes, B.P. Williams, F. King, and G.J. Hutchings, "Promotion of Fe<sub>3</sub>O<sub>4</sub>/Cr<sub>2</sub>O<sub>3</sub> high temperature water gas shift catalyst," *Catalysis Communications*, vol. 3, pp. 381–384, 2002.

---

**Application Library path:** Chemical\_Reaction\_Engineering\_Module/  
Reactors\_with\_Porous\_Catalysts/steam\_reformer

---

### *Modeling Instructions*

---

From the **File** menu, choose **New**.

#### **NEW**

In the **New** window, click  **Blank Model**.

Begin by adding a **Thermodynamic system** including all the chemical species present in the system.

#### **GLOBAL DEFINITIONS**

In the **Physics** toolbar, click  **Thermodynamics** and choose **Thermodynamic System**.

#### **SELECT SYSTEM**

- 1 Go to the **Select System** window.
- 2 Click the **Next** button in the window toolbar.

#### **SELECT SPECIES**

- 1 Go to the **Select Species** window.
- 2 In the **Species** list box, select **propane (74-98-6, C3H8)**.
- 3 Click **+ Add Selected**.
- 4 In the **Species** list box, select **water (7732-18-5, H2O)**.
- 5 Click **+ Add Selected**.
- 6 In the **Species** list box, select **hydrogen (1333-74-0, H2)**.
- 7 Click **+ Add Selected**.
- 8 In the **Species** list box, select **carbon dioxide (124-38-9, CO2)**.
- 9 Click **+ Add Selected**.
- 10 In the **Species** list box, select **carbon monoxide (630-08-0, CO)**.
- 11 Click **+ Add Selected**.
- 12 Click the **Next** button in the window toolbar.

## SELECT THERMODYNAMIC MODEL

- 1 Go to the **Select Thermodynamic Model** window.
- 2 Click the **Finish** button in the window toolbar.

## GLOBAL DEFINITIONS

### *Gas System 1 (pp1)*

With a **Thermodynamic system** in place, it is straightforward to set up the **Chemistry** interface using **Generate Chemistry**.

- 1 Right-click **Global Definitions > Thermodynamics > Gas System 1 (pp1)** and choose **Generate Chemistry**.

## SELECT SPECIES

- 1 Go to the **Select Species** window.
- 2 Click  **Add All**.
- 3 Click the **Next** button in the window toolbar.

## CHEMISTRY SETTINGS

- 1 Go to the **Chemistry Settings** window.
- 2 From the **Mass transfer** list, choose **Concentrated species**.
- 3 Click the **Finish** button in the window toolbar.

## GLOBAL DEFINITIONS

A set of parameters that are useful when building the model are available in a text file. In the next steps load these into the parameters section.

### *Parameters 1*

- 1 In the **Model Builder** window, under **Global Definitions** click **Parameters 1**.
- 2 In the **Settings** window for **Parameters**, locate the **Parameters** section.
- 3 Click  **Load from File**.
- 4 Browse to the model's Application Libraries folder and double-click the file `steam_reformer_parameters.txt`.

## GEOMETRY 1

Now create the geometry. To simplify this step, insert a prepared geometry sequence:

- 1 In the **Model Builder** window, under **Component 1 (comp1)** click **Geometry 1**.
- 2 In the **Geometry** toolbar, point to **Import/Export** and choose **Insert Sequence**.

- 3 Browse to the model's Application Libraries folder and double-click the file `steam_reformer_geom_sequence.mph`.
- 4 Click **Build All** in the **Geometry** toolbar.

The imported sequence contains all required selections in addition to the actual geometry. Selections facilitate the work of assigning materials, setting boundary conditions, and plot the results.

If you want to know how to create such a geometry, you can follow the tutorial under `applications/COMSOL_Multiphysics/Geometry_Tutorials`.

## DEFINITIONS

### *Integration 1 (intop1)*

- 1 In the **Definitions** toolbar, click  **Nonlocal Couplings** and choose **Integration**.
- 2 In the **Settings** window for **Integration**, locate the **Source Selection** section.
- 3 From the **Geometric entity level** list, choose **Boundary**.
- 4 From the **Selection** list, choose **Bed Inlet (Work Plane 1)**.

Create the materials for hot gas (air), insulating jacket, and catalytic bed.

## MATERIALS



### *Catalyst*

- 1 In the **Model Builder** window, under **Component 1 (comp1)** right-click **Materials** and choose **Blank Material**.
- 2 In the **Settings** window for **Material**, type **Catalyst** in the **Label** text field.

### *Insulation*

- 1 Right-click **Materials** and choose **Blank Material**.
- 2 In the **Settings** window for **Material**, type **Insulation** in the **Label** text field.
- 3 Locate the **Geometric Entity Selection** section. From the **Selection** list, choose **Jacket**.

## ADD MATERIAL

- 1 In the **Materials** toolbar, click  **Add Material** to open the **Add Material** window.
- 2 Go to the **Add Material** window.
- 3 In the tree, select **Built-in > Air**.
- 4 Click the **Add to Component** button in the window toolbar.
- 5 In the **Materials** toolbar, click  **Add Material** to close the **Add Material** window.

## MATERIALS

*Air (mat3)*

- 1 In the **Settings** window for **Material**, locate the **Geometric Entity Selection** section.
- 2 From the **Selection** list, choose **Heating Tubes**.

*Porous Material 1 (pmat1)*

- 1 Right-click **Materials** and choose **More Materials > Porous Material**.
- 2 In the **Settings** window for **Porous Material**, locate the **Geometric Entity Selection** section.
- 3 From the **Selection** list, choose **Catalytic Bed**.

Now add the physics interfaces. When they are all added, go back to each of the interfaces, assign them to their domains, and add the necessary feature nodes. Based on this, COMSOL automatically detects which material properties are needed and you can then fill them in.

## ADD PHYSICS

- 1 In the **Home** toolbar, click  **Add Physics** to open the **Add Physics** window.
- 2 Go to the **Add Physics** window.
- 3 In the tree, select **Chemical Species Transport > Transport of Concentrated Species (tcs)**.
- 4 Click the **Add to Component 1** button in the window toolbar.

## TRANSPORT OF CONCENTRATED SPECIES (TCS)

- 1 In the **Settings** window for **Transport of Concentrated Species**, locate the **Transport Mechanisms** section.
- 2 Select the **Mass transfer in porous media** checkbox.
- 3 Click to expand the **Dependent Variables** section. In the **Number of species** text field, type 5.
- 4 In the **Mass fractions (I)** table, enter the following settings:

<u>w_H2O</u>
<u>w_C3H8</u>
<u>w_H2</u>
<u>w_CO2</u>
<u>w_CO</u>

## ADD PHYSICS

- 1 Go to the **Add Physics** window.

- 2 In the tree, select **Fluid Flow > Porous Media and Subsurface Flow > Darcy's Law (dl)**.
- 3 Click the **Add to Component I** button in the window toolbar.

#### **DARCY'S LAW (DL)**

- 1 In the **Settings** window for **Darcy's Law**, locate the **Physical Model** section.
- 2 In the  $p_{ref}$  text field, type  $p_{ref}$ .
- 3 Click to expand the **Dependent Variables** section. In the **Pressure (Pa)** text field, type  $p_{sr}$ .

#### **ADD PHYSICS**

- 1 Go to the **Add Physics** window.
- 2 In the tree, select **Heat Transfer > Porous Media > Heat Transfer in Porous Media (ht)**.
- 3 Click the **Add to Component I** button in the window toolbar.

#### **HEAT TRANSFER IN POROUS MEDIA (HT)**

- 1 In the **Settings** window for **Heat Transfer in Porous Media**, click to expand the **Dependent Variables** section.
- 2 In the **Temperature (K)** text field, type  $T_{sr}$ .

#### **ADD PHYSICS**

- 1 Go to the **Add Physics** window.
- 2 In the tree, select **Fluid Flow > Nonisothermal Flow > Laminar Flow**.
- 3 Click the **Add to Component I** button in the window toolbar.
- 4 In the **Physics** toolbar, click  **Add Physics** to close the **Add Physics** window.

#### **LAMINAR FLOW (SPF)**

- 1 In the **Settings** window for **Laminar Flow**, locate the **Physical Model** section.
- 2 In the  $p_{ref}$  text field, type  $p_{ref}$ .
- 3 Click to expand the **Dependent Variables** section. In the **Pressure (Pa)** text field, type  $p_{tubes}$ .

#### **HEAT TRANSFER IN FLUIDS 2 (HT2)**

- 1 In the **Model Builder** window, under **Component I (comp1)** click **Heat Transfer in Fluids 2 (ht2)**.
- 2 In the **Settings** window for **Heat Transfer in Fluids**, click to expand the **Dependent Variables** section.

3 In the **Temperature (K)** text field, type T\_tubes.

### CHEMISTRY (CHEM)

1 In the **Model Builder** window, under **Component 1 (comp1)** click **Chemistry (chem)**.

2 In the **Settings** window for **Chemistry**, locate the **Species Matching** section.

3 Find the **Bulk species** subsection. From the **Species solved for** list, choose **Transport of Concentrated Species**.

4 In the table, enter the following settings:

Species	Type	Mass fraction	Value (1)	From Thermodynamics
C3H8	Free species	w_C3H8	Solved for	C3H8
CO	Free species	w_CO	Solved for	CO
CO2	Free species	w_CO2	Solved for	CO2
H2	Free species	w_H2	Solved for	H2
H2O	Free species	w_H2O	Solved for	H2O

#### Reaction 1

1 In the **Physics** toolbar, click  **Domains** and choose **Reaction**.

2 In the **Settings** window for **Reaction**, locate the **Reaction Formula** section.

3 In the **Formula** text field, type  $C_3H_8 + H_2O \Rightarrow H_2 + CO_2$ .

4 Click **Balance** in the upper-right corner of the **Reaction Formula** section.

5 Locate the **Reaction Rate** section. From the list, choose **User defined**.

6 In the  $r_j$  text field, type  $chem.kf_1*chem.c_{C3H8}$ .

7 Locate the **Reaction Orders** section. Find the **Volumetric overall reaction order** subsection. In the **Forward** text field, type 1.

8 Locate the **Rate Constants** section. Select the **Use Arrhenius expressions** checkbox.

9 In the  $A^f$  text field, type A.

10 In the  $E^f$  text field, type Ea.

#### Reaction 2

1 In the **Physics** toolbar, click  **Domains** and choose **Reaction**.

- 2 In the **Settings** window for **Reaction**, locate the **Reaction Formula** section.
- 3 In the **Formula** text field, type  $\text{CO} + \text{H}_2\text{O} \rightleftharpoons \text{CO}_2 + \text{H}_2$ .
- 4 Click **Apply**.
- 5 Locate the **Rate Constants** section. Select the **Specify equilibrium constant** checkbox.
- 6 Select the **Use Arrhenius expressions** checkbox.
- 7 In the  $A^f$  text field, type  $A\_wgs$ .
- 8 In the  $E^f$  text field, type  $Ea\_wgs$ .

#### **TRANSPORT OF CONCENTRATED SPECIES IN BED**

- 1 In the **Model Builder** window, under **Component 1 (comp1)** click **Transport of Concentrated Species (tcs)**.
- 2 In the **Settings** window for **Transport of Concentrated Species**, type **Transport of Concentrated Species in Bed** in the **Label** text field.
- 3 Locate the **Domain Selection** section. From the **Selection** list, choose **Catalytic Bed**.
- 4 Locate the **Transport Mechanisms** section. From the **Diffusion model** list, choose **Maxwell–Stefan**.

#### *Initial Values 1*

- 1 In the **Model Builder** window, under **Component 1 (comp1)** > **Transport of Concentrated Species in Bed (tcs)** click **Initial Values 1**.
- 2 In the **Settings** window for **Initial Values**, locate the **Initial Values** section.
- 3 In the  $\omega_{0,w\text{C}_3\text{H}_8}$  text field, type  $w\_C3H8\_in$ .
- 4 In the  $\omega_{0,w\text{H}_2}$  text field, type  $w\_H2\_in$ .
- 5 In the  $\omega_{0,w\text{CO}_2}$  text field, type  $w\_CO2\_in$ .
- 6 In the  $\omega_{0,w\text{CO}}$  text field, type  $w\_CO\_in$ .

#### *Porous Medium 1*

- 1 In the **Physics** toolbar, click  **Domains** and choose **Porous Medium**.
- 2 In the **Settings** window for **Porous Medium**, locate the **Domain Selection** section.
- 3 From the **Selection** list, choose **Catalytic Bed**.

#### *Fluid 1*

- 1 In the **Model Builder** window, click **Fluid 1**.
- 2 In the **Settings** window for **Fluid**, locate the **Convection** section.
- 3 From the **u** list, choose **Total Darcy velocity field (dl/porous1)**.

4 Locate the **Diffusion** section. In the table, enter the following settings:

Species 1	Species 2	Diffusivity	Diffusion coefficient (m <sup>2</sup> /s)
w_H2O	w_C3H8	Maxwell-Stefan diffusivity, C3H8-H2O (chem)	comp l.chem.D_C3H8_H2O
w_H2O	w_H2	Maxwell-Stefan diffusivity, H2-H2O (chem)	comp l.chem.D_H2_H2O
w_H2O	w_CO2	Maxwell-Stefan diffusivity, CO2-H2O (chem)	comp l.chem.D_CO2_H2O
w_H2O	w_CO	Maxwell-Stefan diffusivity, CO-H2O (chem)	comp l.chem.D_CO_H2O
w_C3H8	w_H2	Maxwell-Stefan diffusivity, C3H8-H2 (chem)	comp l.chem.D_C3H8_H2
w_C3H8	w_CO2	Maxwell-Stefan diffusivity, C3H8-CO2 (chem)	comp l.chem.D_C3H8_CO2
w_C3H8	w_CO	Maxwell-Stefan diffusivity, C3H8-CO (chem)	comp l.chem.D_C3H8_CO
w_H2	w_CO2	Maxwell-Stefan diffusivity, CO2-H2 (chem)	comp l.chem.D_CO2_H2
w_H2	w_CO	Maxwell-Stefan diffusivity, CO-H2 (chem)	comp l.chem.D_CO_H2
w_CO2	w_CO	Maxwell-Stefan diffusivity, CO-CO2 (chem)	comp l.chem.D_CO_CO2

#### *Porous Matrix 1*

- 1 In the **Model Builder** window, click **Porous Matrix 1**.
- 2 In the **Settings** window for **Porous Matrix**, locate the **Matrix Properties** section.
- 3 From the  $\epsilon_p$  list, choose **From material**.

#### *Reaction Sources 1*

- 1 In the **Physics** toolbar, click  **Domains** and choose **Reaction Sources**.
- 2 In the **Settings** window for **Reaction Sources**, locate the **Domain Selection** section.
- 3 From the **Selection** list, choose **Catalytic Bed**.
- 4 Locate the **Reactions** section. From the **Chemistry** list, choose **Chemistry (chem)**.

#### *Inflow 1*

In the **Physics** toolbar, click  **Boundaries** and choose **Inflow**.

## DEFINITIONS

### Variables I

- 1 In the **Definitions** toolbar, click  **Local Variables**.
- 2 In the **Settings** window for **Variables**, locate the **Variables** section.
- 3 In the table, enter the following settings:

Name	Expression	Unit	Description
J_in_C3H8	$\text{intop1}(\text{tcs.rho} \cdot \text{dl.U} \cdot \text{w}_{\text{C3H8\_in}})$	kg/s	Mass flow rate, C3H8
J_in_H2	$\text{intop1}(\text{tcs.rho} \cdot \text{dl.U} \cdot \text{w}_{\text{H2\_in}})$	kg/s	Mass flow rate, H2
J_in_CO2	$\text{intop1}(\text{tcs.rho} \cdot \text{dl.U} \cdot \text{w}_{\text{CO2\_in}})$	kg/s	Mass flow rate, CO2
J_in_CO	$\text{intop1}(\text{tcs.rho} \cdot \text{dl.U} \cdot \text{w}_{\text{CO\_in}})$	kg/s	Mass flow rate, CO

## TRANSPORT OF CONCENTRATED SPECIES IN BED (TCS)

### Inflow I

- 1 In the **Model Builder** window, under **Component 1 (comp1)** > **Transport of Concentrated Species in Bed (tcs)** click **Inflow I**.
- 2 In the **Settings** window for **Inflow**, locate the **Boundary Selection** section.
- 3 From the **Selection** list, choose **Bed Inlet (Work Plane 1)**.
- 4 Locate the **Inflow** section. From the **Mixture specification** list, choose **Mass flow rates**.
- 5 In the  $J_{\text{in,wC3H8}}$  text field, type J\_in\_C3H8.
- 6 In the  $J_{\text{in,wH2}}$  text field, type J\_in\_H2.
- 7 In the  $J_{\text{in,wCO2}}$  text field, type J\_in\_CO2.
- 8 In the  $J_{\text{in,wCO}}$  text field, type J\_in\_CO.

### Outflow I

- 1 In the **Physics** toolbar, click  **Boundaries** and choose **Outflow**.
- 2 In the **Settings** window for **Outflow**, locate the **Boundary Selection** section.
- 3 From the **Selection** list, choose **Bed Outlet**.

## DARCY'S LAW IN BED

- 1 In the **Model Builder** window, under **Component 1 (comp1)** click **Darcy's Law (dl)**.
- 2 In the **Settings** window for **Darcy's Law**, type Darcy's Law in Bed in the **Label** text field.

- 3 Locate the **Domain Selection** section. From the **Selection** list, choose **Catalytic Bed**.

#### *Fluid 1*

- 1 In the **Model Builder** window, under **Component 1 (comp1) > Darcy's Law in Bed (dl) > Porous Medium 1** click **Fluid 1**.
- 2 In the **Settings** window for **Fluid**, locate the **Fluid Properties** section.
- 3 From the  $\rho$  list, choose **Density (tcs)**.
- 4 From the  $\mu$  list, choose **Dynamic viscosity (chem)**.

#### *Inlet 1*

- 1 In the **Physics** toolbar, click  **Boundaries** and choose **Inlet**.
- 2 In the **Settings** window for **Inlet**, locate the **Boundary Condition** section.
- 3 From the **Boundary condition** list, choose **Pressure**.
- 4 Locate the **Pressure** section. In the  $p_0$  text field, type `p_in_sr`.
- 5 Locate the **Boundary Selection** section. From the **Selection** list, choose **Bed Inlet (Work Plane 1)**.

#### *Outlet 1*

- 1 In the **Physics** toolbar, click  **Boundaries** and choose **Outlet**.
- 2 In the **Settings** window for **Outlet**, locate the **Boundary Selection** section.
- 3 From the **Selection** list, choose **Bed Outlet**.
- 4 Locate the **Boundary Condition** section. From the **Boundary condition** list, choose **Pressure**.

#### *Symmetry 1*

- 1 In the **Physics** toolbar, click  **Boundaries** and choose **Symmetry**.
- 2 In the **Settings** window for **Symmetry**, locate the **Boundary Selection** section.
- 3 From the **Selection** list, choose **Bed Symmetry**.

### **HEAT TRANSFER IN POROUS MEDIA IN BED**

- 1 In the **Model Builder** window, under **Component 1 (comp1)** click **Heat Transfer in Porous Media (ht)**.
- 2 In the **Settings** window for **Heat Transfer in Porous Media**, type `Heat Transfer in Porous Media in Bed` in the **Label** text field.
- 3 Select Domains 1 and 3 only.

### *Fluid 1*

- 1 In the **Model Builder** window, under **Component 1 (comp1)** > **Heat Transfer in Porous Media in Bed (ht)** > **Porous Medium 1** click **Fluid 1**.
- 2 In the **Settings** window for **Fluid**, locate the **Heat Convection** section.
- 3 From the **u** list, choose **Total Darcy velocity field (dl/porous1)**.
- 4 Locate the **Heat Conduction, Fluid** section. From the  $k_f$  list, choose **Thermal conductivity (chem)**.
- 5 Locate the **Thermodynamics, Fluid** section. From the  $\rho_f$  list, choose **Density (tcs)**.
- 6 From the  $C_{p,f}$  list, choose **Heat capacity at constant pressure (chem)**.
- 7 From the  $\gamma$  list, choose **Ratio of specific heats (chem)**.

### *Porous Matrix 1*

- 1 In the **Model Builder** window, click **Porous Matrix 1**.
- 2 In the **Settings** window for **Porous Matrix**, locate the **Matrix Properties** section.
- 3 From the **Define** list, choose **Solid phase properties**.

### *Initial Values 1*

- 1 In the **Model Builder** window, under **Component 1 (comp1)** > **Heat Transfer in Porous Media in Bed (ht)** click **Initial Values 1**.
- 2 In the **Settings** window for **Initial Values**, locate the **Initial Values** section.
- 3 In the  $T_{sr}$  text field, type  $T_{in\_sr}$ .

### *Solid 1*

- 1 In the **Physics** toolbar, click  **Domains** and choose **Solid**.
- 2 In the **Settings** window for **Solid**, locate the **Domain Selection** section.
- 3 From the **Selection** list, choose **Jacket**.

### *Temperature 1*

- 1 In the **Physics** toolbar, click  **Boundaries** and choose **Temperature**.
- 2 In the **Settings** window for **Temperature**, locate the **Boundary Selection** section.
- 3 From the **Selection** list, choose **Bed Inlet (Work Plane 1)**.
- 4 Locate the **Temperature** section. In the  $T_0$  text field, type  $T_{in\_sr}$ .

### *Outflow 1*

- 1 In the **Physics** toolbar, click  **Boundaries** and choose **Outflow**.
- 2 In the **Settings** window for **Outflow**, locate the **Boundary Selection** section.
- 3 From the **Selection** list, choose **Bed Outlet**.

### Heat Flux 1

- 1 In the **Physics** toolbar, click  **Boundaries** and choose **Heat Flux**.
- 2 In the **Settings** window for **Heat Flux**, locate the **Boundary Selection** section.
- 3 From the **Selection** list, choose **Tubes/Bed**.
- 4 Locate the **Heat Flux** section. From the **Flux type** list, choose **Convective heat flux**.
- 5 In the  $h$  text field, type `h_tubes`.
- 6 In the  $T_{\text{ext}}$  text field, type `T_tubes`.

### Heat Flux 2

- 1 In the **Physics** toolbar, click  **Boundaries** and choose **Heat Flux**.
- 2 In the **Settings** window for **Heat Flux**, locate the **Boundary Selection** section.
- 3 From the **Selection** list, choose **Jacket/Ambient**.
- 4 Locate the **Heat Flux** section. From the **Flux type** list, choose **Convective heat flux**.
- 5 In the  $h$  text field, type `h_j`.
- 6 In the  $T_{\text{ext}}$  text field, type `T_amb`.

### Heat Source 1

- 1 In the **Physics** toolbar, click  **Domains** and choose **Heat Source**.  
When choosing the heat of reactions, we can choose among `chem` and `tcs`, the latter takes the porosity into account, and is therefore the natural choice .
- 2 In the **Settings** window for **Heat Source**, locate the **Heat Source** section.
- 3 From the  $Q_0$  list, choose **Heat of reactions (tcs)**.
- 4 Locate the **Domain Selection** section. From the **Selection** list, choose **Catalytic Bed**.

## LAMINAR FLOW IN HEATING TUBES

- 1 In the **Model Builder** window, under **Component 1 (comp1)** click **Laminar Flow (spf)**.
- 2 In the **Settings** window for **Laminar Flow**, type `Laminar Flow in Heating Tubes` in the **Label** text field.
- 3 Locate the **Domain Selection** section. From the **Selection** list, choose **Heating Tubes**.

### Inlet 1

- 1 In the **Physics** toolbar, click  **Boundaries** and choose **Inlet**.  
Use a single inlet node for both co-current and Countercurrent by selecting both inlets and outlets. The unused inlets will be overridden with an appropriate outlet node.
- 2 In the **Settings** window for **Inlet**, locate the **Boundary Selection** section.

- 3 From the **Selection** list, choose **Inlets and Outlets**.
- 4 Locate the **Boundary Condition** section. From the list, choose **Fully developed flow**.
- 5 Locate the **Fully Developed Flow** section. In the  $U_{av}$  text field, type  $u_{in\_tubes}$ .

#### *Outlet Countercurrent*

- 1 In the **Physics** toolbar, click  **Boundaries** and choose **Outlet**.
- 2 In the **Settings** window for **Outlet**, type Outlet Countercurrent in the **Label** text field.
- 3 Locate the **Boundary Selection** section. From the **Selection** list, choose **Tubes Outlet (Work Plane 1)**.
- 4 Locate the **Pressure Conditions** section. Select the **Normal flow** checkbox.

#### *Outlet Co-current*

- 1 In the **Physics** toolbar, click  **Boundaries** and choose **Outlet**.
- 2 In the **Settings** window for **Outlet**, type Outlet Co-current in the **Label** text field.
- 3 Locate the **Boundary Selection** section. From the **Selection** list, choose **Tubes Inlet**.

#### *Symmetry 1*

- 1 In the **Physics** toolbar, click  **Boundaries** and choose **Symmetry**.
- 2 In the **Settings** window for **Symmetry**, locate the **Boundary Selection** section.
- 3 From the **Selection** list, choose **Tubes Symmetry**.

### **HEAT TRANSFER IN HEATING TUBES**

- 1 In the **Model Builder** window, under **Component 1 (comp1)** click **Heat Transfer in Fluids 2 (ht2)**.
- 2 In the **Settings** window for **Heat Transfer in Fluids**, type Heat Transfer in Heating Tubes in the **Label** text field.
- 3 Locate the **Domain Selection** section. From the **Selection** list, choose **Heating Tubes**.

#### *Initial Values 1*

- 1 In the **Model Builder** window, under **Component 1 (comp1)** > **Heat Transfer in Heating Tubes (ht2)** click **Initial Values 1**.
- 2 In the **Settings** window for **Initial Values**, locate the **Initial Values** section.
- 3 In the  $T_{tubes}$  text field, type  $T_{in\_tubes}$ .

#### *Temperature at Inlet*

- 1 In the **Physics** toolbar, click  **Boundaries** and choose **Temperature**.

- 2 In the **Settings** window for **Temperature**, type Temperature at Inlet in the **Label** text field.
- 3 Locate the **Boundary Selection** section. From the **Selection** list, choose **Inlets and Outlets**.
- 4 Locate the **Temperature** section. In the  $T_0$  text field, type T\_in\_tubes.

#### *Outflow Countercurrent*

- 1 In the **Physics** toolbar, click  **Boundaries** and choose **Outflow**.
- 2 In the **Settings** window for **Outflow**, type Outflow Countercurrent in the **Label** text field.
- 3 Locate the **Boundary Selection** section. From the **Selection** list, choose **Tubes Outlet (Work Plane I)**.

#### *Outflow Co-current*

- 1 Right-click **Outflow Countercurrent** and choose **Duplicate**.
- 2 In the **Settings** window for **Outflow**, type Outflow Co-current in the **Label** text field.
- 3 Locate the **Boundary Selection** section. From the **Selection** list, choose **Tubes Inlet**.

#### *Heat Flux to bed*

- 1 In the **Physics** toolbar, click  **Boundaries** and choose **Heat Flux**.
- 2 In the **Settings** window for **Heat Flux**, type Heat Flux to bed in the **Label** text field.
- 3 Locate the **Boundary Selection** section. From the **Selection** list, choose **Tubes/Bed**.
- 4 Locate the **Heat Flux** section. From the **Flux type** list, choose **Convective heat flux**.
- 5 In the  $h$  text field, type h\_tubes.
- 6 In the  $T_{\text{ext}}$  text field, type T\_sr.

## **MATERIALS**

Now, after the physics is set up, you can fill in the required material properties.

#### *Porous Material 1 (pmat1)*

- 1 In the **Model Builder** window, under **Component 1 (comp1) > Materials** click **Porous Material 1 (pmat1)**.
- 2 In the **Settings** window for **Porous Material**, locate the **Homogenized Properties** section.

3 In the table, enter the following settings:

Property	Variable	Value	Unit	Property group
Permeability	kappa_iso ; kappaii = kappa_iso, kappaij = 0	kappa_pm	m <sup>2</sup>	Basic

4 Locate the **Phase-Specific Properties** section. Click  **Add Required Phase Nodes**.

*Solid 1 (pmat1.solid1)*

- 1 In the **Model Builder** window, click **Solid 1 (pmat1.solid1)**.
- 2 In the **Settings** window for **Solid**, locate the **Solid Properties** section.
- 3 From the **Material** list, choose **Catalyst (mat1)**.
- 4 In the  $\theta_s$  text field, type 1-porosity.

*Catalyst (mat1)*

- 1 In the **Model Builder** window, under **Component 1 (comp1) > Materials** click **Catalyst (mat1)**.
- 2 In the **Settings** window for **Material**, locate the **Material Contents** section.
- 3 In the table, enter the following settings:

Property	Variable	Value	Unit	Property group
Thermal conductivity	k_iso ; kii = k_iso, kij = 0	k_pm	W/(m·K)	Basic
Density	rho	dens_pm	kg/m <sup>3</sup>	Basic
Heat capacity at constant pressure	Cp	Cp_pm	J/(kg·K)	Basic

*Insulation (mat2)*

- 1 In the **Model Builder** window, click **Insulation (mat2)**.
- 2 In the **Settings** window for **Material**, locate the **Material Contents** section.

3 In the table, enter the following settings:

Property	Variable	Value	Unit	Property group
Thermal conductivity	k_iso ; kii = k_iso, kij = 0	k_foam	W/(m·K)	Basic
Density	rho	dens_foam	kg/m <sup>3</sup>	Basic
Heat capacity at constant pressure	Cp	Cp_foam	J/(kg·K)	Basic

### MESH I

Now add a mesh. The mesh will consist of free quads (bed), free triangles (tube and jacket), boundary layers on the bed/tube boundaries, and boundary layers in the *x* direction on the inlets and outlets selection.

#### Free Quad I

- 1 In the **Mesh** toolbar, click  **More Generators** and choose **Free Quad**.
- 2 In the **Settings** window for **Free Quad**, locate the **Boundary Selection** section.
- 3 From the **Selection** list, choose **Bed Inlet (Work Plane 1)**.

#### Size I

- 1 In the **Mesh** toolbar, click **Size Attribute** and choose **Normal**.
- 2 In the **Settings** window for **Size**, locate the **Element Size** section.
- 3 Click the **Custom** button.
- 4 Locate the **Element Size Parameters** section.
- 5 Select the **Maximum element size** checkbox. In the associated text field, type  $2e-3/1.08$ .

#### Size

- 1 In the **Model Builder** window, under **Component 1 (comp1) > Mesh 1** click **Size**.
- 2 In the **Settings** window for **Size**, locate the **Element Size** section.
- 3 Click the **Custom** button.
- 4 Locate the **Element Size Parameters** section. In the **Maximum element size** text field, type  $2e-3$ .
- 5 In the **Minimum element size** text field, type  $1e-3$ .

#### Free Triangular I

- 1 In the **Mesh** toolbar, click  **More Generators** and choose **Free Triangular**.
- 2 In the **Settings** window for **Free Triangular**, locate the **Boundary Selection** section.

- 3 From the **Selection** list, choose **Tubes Outlet (Work Plane 1)**.
- 4 Select Boundaries 4, 9, 13, and 17 only.

#### *Boundary Layers 1*

- 1 In the **Mesh** toolbar, click  **Boundary Layers**.
- 2 In the **Settings** window for **Boundary Layers**, locate the **Geometric Entity Selection** section.
- 3 From the **Geometric entity level** list, choose **Boundary**.
- 4 From the **Selection** list, choose **Tubes Outlet (Work Plane 1)**.
- 5 Select Boundaries 1, 4, 13, and 17 only.



#### *Boundary Layer Properties*

- 1 In the **Model Builder** window, click **Boundary Layer Properties**.
- 2 In the **Settings** window for **Boundary Layer Properties**, locate the **Edge Selection** section.
- 3 Click  **Paste Selection**.
- 4 In the **Paste Selection** dialog, type 5 8 16 17 19 21 24 27 in the **Selection** text field.
- 5 Click **OK**. Alternatively, click in the **Graphics** window to select the bed/tube boundaries.
- 6 In the **Settings** window for **Boundary Layer Properties**, locate the **Layers** section.
- 7 In the **Number of layers** text field, type 3.
- 8 From the **Thickness specification** list, choose **First layer**.
- 9 In the **Thickness** text field, type 3e-4.

#### *Swept 1*

In the **Mesh** toolbar, click  **Swept**.

#### *Distribution 1*

- 1 In the **Mesh** toolbar, click  **Distribution**.
- 2 In the **Settings** window for **Distribution**, locate the **Distribution** section.
- 3 In the **Number of elements** text field, type 50.
- 4 Click  **Build All**.



#### *Boundary Layers 2*

- 1 In the **Mesh** toolbar, click  **Boundary Layers**.
- 2 In the **Settings** window for **Boundary Layers**, click to expand the **Transition** section.
- 3 Clear the **Smooth transition to interior mesh** checkbox.

### *Boundary Layer Properties*

- 1 In the **Model Builder** window, click **Boundary Layer Properties**.
- 2 In the **Settings** window for **Boundary Layer Properties**, locate the **Geometric Entity Selection** section.
- 3 From the **Selection** list, choose **Inlets and Outlets**.
- 4 Locate the **Layers** section. From the **Thickness specification** list, choose **First layer**.
- 5 In the **Number of layers** text field, type 6.
- 6 In the **Thickness** text field, type 0.0003.
- 7 Click  **Build All**.  
Use the **Statistics** feature to get information about the mesh.
- 8 In the **Model Builder** window, right-click **Mesh 1** and choose **Statistics**.

### **ADD STUDY**

- 1 In the **Home** toolbar, click  **Add Study** to open the **Add Study** window.
- 2 Go to the **Add Study** window.
- 3 Find the **Studies** subsection. In the **Select Study** tree, select **General Studies > Stationary**.
- 4 Right-click and choose **Add Study**.
- 5 In the **Home** toolbar, click  **Add Study** to close the **Add Study** window.

### **COUNTERCURRENT T\_IN\_TUBES = 900K**

- 1 In the **Settings** window for **Study**, type Countercurrent T\_in\_tubes = 900K in the **Label** text field.
- 2 Locate the **Study Settings** section. Clear the **Generate default plots** checkbox.

### *Solution 1 (sol1)*

In the **Study** toolbar, click  **Show Default Solver**.

### *Step 1: Stationary*

- 1 In the **Model Builder** window, under **Countercurrent T\_in\_tubes = 900K** click **Step 1: Stationary**.
- 2 In the **Settings** window for **Stationary**, locate the **Physics and Variables Selection** section.
- 3 In the **Solve for** column of the table, under **Component 1 (comp1)**, clear the checkboxes for **Chemistry (chem)**, **Transport of Concentrated Species in Bed (tcs)**, **Heat Transfer in Porous Media in Bed (ht)**, **Laminar Flow in Heating Tubes (spf)**, and **Heat Transfer in Heating Tubes (ht2)**.

- 4 In the **Solve for** column of the table, under **Component 1 (comp1) > Multiphysics**, clear the checkbox for **Nonisothermal Flow 1 (nitf1)**.

*Step 2: Stationary 1*

- 1 Right-click **Countercurrent T\_in\_tubes = 900K > Step 1: Stationary** and choose **Duplicate**.
- 2 In the **Settings** window for **Stationary**, locate the **Physics and Variables Selection** section.
- 3 In the **Solve for** column of the table, under **Component 1 (comp1)**, clear the checkbox for **Darcy's Law in Bed (dl)**.
- 4 In the **Solve for** column of the table, under **Component 1 (comp1)**, select the checkbox for **Laminar Flow in Heating Tubes (spf)**.
- 5 Select the **Modify model configuration for study step** checkbox.
- 6 In the tree, select **Component 1 (comp1) > Laminar Flow in Heating Tubes (spf) > Outlet Co-current**.
- 7 Right-click and choose **Disable**.
- 8 In the tree, select **Component 1 (comp1) > Heat Transfer in Heating Tubes (ht2) > Outflow Co-current**.
- 9 Click  **Disable**.

*Step 3: Stationary 2*

- 1 Right-click **Step 2: Stationary 1** and choose **Duplicate**.
- 2 In the **Settings** window for **Stationary**, locate the **Physics and Variables Selection** section.
- 3 Clear the **Modify model configuration for study step** checkbox.
- 4 In the **Solve for** column of the table, under **Component 1 (comp1)**, select the checkboxes for **Chemistry (chem)**, **Transport of Concentrated Species in Bed (tcs)**, **Darcy's Law in Bed (dl)**, **Heat Transfer in Porous Media in Bed (ht)**, and **Heat Transfer in Heating Tubes (ht2)**.
- 5 In the **Solve for** column of the table, under **Component 1 (comp1) > Multiphysics**, select the checkbox for **Nonisothermal Flow 1 (nitf1)**.
- 6 Select the **Modify model configuration for study step** checkbox.



*Solution 1 (sol1)*

- 1 In the **Study** toolbar, click  **Show Default Solver**.
- 2 In the **Model Builder** window, expand the **Solution 1 (sol1)** node.
- 3 In the **Model Builder** window, expand the **Countercurrent T\_in\_tubes = 900K > Solver Configurations > Solution 1 (sol1) > Stationary Solver 3** node.

- 4 Right-click **Countercurrent T\_in\_tubes = 900K** > **Solver Configurations** > **Solution 1 (sol1)** > **Stationary Solver 3** and choose **Fully Coupled**.

*Step 1: Stationary, Step 2: Stationary 1, Step 3: Stationary 2*  
Right-click and choose **Copy**.





#### **ADD STUDY**

- 1 In the **Study** toolbar, click  **Add Study** to open the **Add Study** window.
- 2 Go to the **Add Study** window.
- 3 Find the **Studies** subsection. In the **Select Study** tree, select **Empty Study**.
- 4 Click the **Add Study** button in the window toolbar.
- 5 In the **Study** toolbar, click  **Add Study** to close the **Add Study** window.

#### **CO-CURRENT T\_IN\_TUBES = 900, 1000 K**





- 1 In the **Settings** window for **Study**, type Co-current T\_in\_tubes = 900, 1000 K in the **Label** text field.
- 2 Locate the **Study Settings** section. Clear the **Generate default plots** checkbox.
- 3 Right-click **Co-current T\_in\_tubes = 900, 1000 K** and choose **Paste Multiple Items**.

*Step 2: Stationary 1*

- 1 In the **Settings** window for **Stationary**, locate the **Physics and Variables Selection** section.
- 2 In the tree, select **Component 1 (comp1)** > **Laminar Flow in Heating Tubes (spf)** > **Outlet Countercurrent**.
- 3 Click  **Disable**.
- 4 In the tree, select **Component 1 (comp1)** > **Laminar Flow in Heating Tubes (spf)** > **Outlet Co-current**.
- 5 Click  **Enable**.
- 6 In the tree, select **Component 1 (comp1)** > **Heat Transfer in Heating Tubes (ht2)** > **Outflow Countercurrent**.
- 7 Click  **Disable**.
- 8 In the tree, select **Component 1 (comp1)** > **Heat Transfer in Heating Tubes (ht2)** > **Outflow Co-current**.
- 9 Click  **Enable**.

*Step 3: Stationary 2*



- 1 In the **Model Builder** window, click **Step 3: Stationary 2**.

- 2 In the **Settings** window for **Stationary**, locate the **Physics and Variables Selection** section.
- 3 In the tree, select **Component 1 (comp1) > Laminar Flow in Heating Tubes (spf) > Outlet Countercurrent**.
- 4 Click  **Disable**.
- 5 In the tree, select **Component 1 (comp1) > Laminar Flow in Heating Tubes (spf) > Outlet Co-current**.
- 6 Click  **Enable**.
- 7 In the tree, select **Component 1 (comp1) > Heat Transfer in Heating Tubes (ht2) > Outflow Countercurrent**.
- 8 Click  **Disable**.
- 9 In the tree, select **Component 1 (comp1) > Heat Transfer in Heating Tubes (ht2) > Outflow Co-current**.
- 10 Click  **Enable**.

*Solution 4 (sol4)*

- 1 In the **Study** toolbar, click  **Show Default Solver**.
- 2 In the **Model Builder** window, expand the **Solution 4 (sol4)** node.
- 3 Right-click **Co-current T\_in\_tubes = 900, 1000 K > Solver Configurations > Solution 4 (sol4) > Stationary Solver 3** and choose **Fully Coupled**.

*Parametric Sweep*

- 1 In the **Study** toolbar, click  **Parametric Sweep**.
- 2 In the **Settings** window for **Parametric Sweep**, locate the **Study Settings** section.
- 3 Click  **Add**.
- 4 In the table, enter the following settings:

Parameter name	Parameter value list	Parameter unit
T_in_tubes (Inlet temperature, heating tubes)	900 1000	K

**COUNTERCURRENT T\_IN\_TUBES = 900K**

In the **Study** toolbar, click  **Compute**.

**RESULTS**

*Cut Plane 1*

- 1 In the **Model Builder** window, expand the **Results** node.

- 2 Right-click **Results > Datasets** and choose **Cut Plane**.
- 3 In the **Settings** window for **Cut Plane**, locate the **Plane Data** section.
- 4 In the **x-coordinate** text field, type L/2.
- 5 Click  **Plot**.





*w\_C3H8 and T at L/2*

- 1 In the **Results** toolbar, click  **3D Plot Group**.
- 2 In the **Settings** window for **3D Plot Group**, type w\_C3H8 and T at L/2 in the **Label** text field.
- 3 Locate the **Data** section. From the **Dataset** list, choose **Cut Plane 1**.
- 4 Click to expand the **Title** section. From the **Title type** list, choose **None**.
- 5 Locate the **Color Legend** section. Select the **Show maximum and minimum values** checkbox.
- 6 Select the **Show units** checkbox.

*Surface 1*

- 1 Right-click **w\_C3H8 and T at L/2** and choose **Surface**.
- 2 In the **Settings** window for **Surface**, locate the **Expression** section.
- 3 In the **Expression** text field, type w\_C3H8.
- 4 Locate the **Coloring and Style** section. From the **Color table** list, choose **Algae**.

*Contour 1*

- 1 In the **Model Builder** window, right-click **w\_C3H8 and T at L/2** and choose **Contour**.
- 2 In the **Settings** window for **Contour**, locate the **Expression** section.
- 3 In the **Expression** text field, type chem.T.
- 4 Locate the **Coloring and Style** section. From the **Contour type** list, choose **Tube**.
- 5 In the **w\_C3H8 and T at L/2** toolbar, click  **Plot**.
- 6 From the **Color table** list, choose **HeatCameraLight**.
- 7 Click the  **Go to YZ View** button in the **Graphics** toolbar.
- 8 Click the  **Show Grid** button in the **Graphics** toolbar.
- 9 Click the  **Zoom Extents** button in the **Graphics** toolbar.

This is [Figure 4](#). Now, plot the mass fractions for all chemical species along the center line of the reactor bed. This is achieved by setting up a 1D Plot Group with one Line Graph for each chemical species. The resulting plot is [Figure 5](#).

- 10 Click the  **Go to Default View** button in the **Graphics** toolbar.

### *Countercurrent Mass Fractions*

- 1 In the **Results** toolbar, click  **ID Plot Group**.
- 2 In the **Settings** window for **ID Plot Group**, type Countercurrent Mass Fractions in the **Label** text field.
- 3 Click to expand the **Title** section. From the **Title type** list, choose **None**.

### *Line Graph 1*

- 1 Right-click **Countercurrent Mass Fractions** and choose **Line Graph**.
- 2 Select Edge 3 only.
- 3 In the **Settings** window for **Line Graph**, locate the **x-Axis Data** section.
- 4 From the **Parameter** list, choose **Expression**.
- 5 In the **Expression** text field, type x.
- 6 Click to expand the **Legends** section. Select the **Show legends** checkbox.
- 7 Find the **Include** subsection. Select the **Expression** checkbox.
- 8 Clear the **Solution** checkbox.
- 9 In the **Countercurrent Mass Fractions** toolbar, click  **Plot**.

### *Line Graph 2*

- 1 Right-click **Line Graph 1** and choose **Duplicate**.
- 2 In the **Settings** window for **Line Graph**, locate the **y-Axis Data** section.
- 3 In the **Expression** text field, type w\_C3H8.

### *Line Graph 3*

- 1 Right-click **Line Graph 2** and choose **Duplicate**.
- 2 In the **Settings** window for **Line Graph**, locate the **y-Axis Data** section.
- 3 In the **Expression** text field, type w\_C0.

### *Line Graph 4*

- 1 Right-click **Line Graph 3** and choose **Duplicate**.
- 2 In the **Settings** window for **Line Graph**, locate the **y-Axis Data** section.
- 3 In the **Expression** text field, type w\_C02.



### *Line Graph 5*

- 1 Right-click **Line Graph 4** and choose **Duplicate**.
- 2 In the **Settings** window for **Line Graph**, locate the **y-Axis Data** section.
- 3 In the **Expression** text field, type w\_H2.

### *Countercurrent Mass Fractions*

- 1 In the **Model Builder** window, click **Countercurrent Mass Fractions**.
- 2 In the **Settings** window for **ID Plot Group**, locate the **Plot Settings** section.
- 3 Select the **y-axis label** checkbox. In the associated text field, type Mass fraction.
- 4 Locate the **Legend** section. From the **Position** list, choose **Upper middle**.  
This is [Figure 5](#).
- 5 Click the  **Zoom Extents** button in the **Graphics** toolbar.

### *Countercurrent mirror*

- 1 In the **Results** toolbar, click  **More Datasets** and choose **Mirror 3D**.
- 2 In the **Settings** window for **Mirror 3D**, type Countercurrent mirror in the **Label** text field.
- 3 Locate the **Plane Data** section. From the **Plane** list, choose **xy-planes**.
- 4 Click  **Plot**.

### *Mass fraction, C3H8 Countercurrent*

- 1 In the **Results** toolbar, click  **3D Plot Group**.
- 2 In the **Settings** window for **3D Plot Group**, type Mass fraction, C3H8 Countercurrent in the **Label** text field.
- 3 Locate the **Data** section. From the **Dataset** list, choose **Countercurrent mirror**.
- 4 Locate the **Title** section. From the **Title type** list, choose **None**.
- 5 Locate the **Plot Settings** section. Clear the **Plot dataset edges** checkbox.
- 6 Locate the **Color Legend** section. Select the **Show units** checkbox.

### *Surface 1*

- 1 In the **Mass fraction, C3H8 Countercurrent** toolbar, click  **Surface**.
- 2 In the **Settings** window for **Surface**, locate the **Expression** section.
- 3 In the **Expression** text field, type w\_C3H8.
- 4 Locate the **Coloring and Style** section. From the **Color table** list, choose **Prism**.

### *Selection 1*

- 1 In the **Mass fraction, C3H8 Countercurrent** toolbar, click  **Selection**.
- 2 In the **Settings** window for **Selection**, locate the **Selection** section.
- 3 From the **Selection** list, choose **Tubes/Bed**.
- 4 Add the inner wall to the selection by selecting boundary 11 in the **Graphics** window.  
Use the scroll wheel to reach interior boundaries.

### *Mass fraction, C3H8 Countercurrent*

In the **Mass fraction, C3H8 Countercurrent** toolbar, click  **Surface**.

#### *Surface 2*

- 1 In the **Settings** window for **Surface**, locate the **Expression** section.
- 2 In the **Expression** text field, type 1.





### *Material Appearance 1*

- 1 In the **Mass fraction, C3H8 Countercurrent** toolbar, click  **Material Appearance**.
- 2 In the **Settings** window for **Material Appearance**, locate the **Appearance** section.
- 3 From the **Appearance** list, choose **Custom**.
- 4 From the **Material type** list, choose **Steel (anodized)**.

#### *Surface 2*

In the **Model Builder** window, click **Surface 2**.

### *Selection 1*

- 1 In the **Mass fraction, C3H8 Countercurrent** toolbar, click  **Selection**.
- 2 Select Boundaries 9, 10, 12, and 26 only.
- 3 In the **Mass fraction, C3H8 Countercurrent** toolbar, click  **Plot**.
- 4 In the **Settings** window for **Selection**, in the **Graphics** window toolbar, click  next to **Scene Light**, then choose **Ambient Occlusion**.
- 5 Click the  **Zoom Extents** button in the **Graphics** toolbar.

### *Concentration, H2 Countercurrent*

- 1 In the **Model Builder** window, right-click **Mass fraction, C3H8 Countercurrent** and choose **Duplicate**.
- 2 In the **Model Builder** window, click **Mass fraction, C3H8 Countercurrent 1**.
- 3 In the **Settings** window for **3D Plot Group**, type Concentration, H2 Countercurrent in the **Label** text field.

#### *Surface 1*

- 1 In the **Model Builder** window, click **Surface 1**.
- 2 In the **Settings** window for **Surface**, click **Replace Expression** in the upper-right corner of the **Expression** section. From the menu, choose **Component 1 (comp1) > Transport of Concentrated Species in Bed > Species w\_H2 > tcs.c\_w\_H2 - Molar concentration - mol/m<sup>3</sup>**.
- 3 In the **Concentration, H2 Countercurrent** toolbar, click  **Plot**.

### *Gas Density, Countercurrent 900 K*

- 1 In the **Model Builder** window, right-click **Mass fraction, C3H8 Countercurrent** and choose **Duplicate**.
- 2 In the **Model Builder** window, click **Mass fraction, C3H8 Countercurrent 1**.
- 3 In the **Settings** window for **3D Plot Group**, type Gas Density, Countercurrent 900 K in the **Label** text field.

### *Surface 1*

- 1 In the **Model Builder** window, click **Surface 1**.
- 2 In the **Settings** window for **Surface**, click **Replace Expression** in the upper-right corner of the **Expression** section. From the menu, choose **Component 1 (comp1) > Darcy's Law in Bed > Material properties > dl.rho - Fluid density - kg/m<sup>3</sup>**.
- 3 Click to expand the **Range** section. Select the **Manual color range** checkbox.
- 4 In the **Minimum** text field, type 0.
- 5 In the **Maximum** text field, type 0.4.
- 6 Locate the **Coloring and Style** section. From the **Color table** list, choose **AuroraAustralisDark**.
- 7 In the **Gas Density, Countercurrent 900 K** toolbar, click  **Plot**.

### *Temperature Countercurrent*

- 1 In the **Results** toolbar, click  **3D Plot Group**.
- 2 In the **Settings** window for **3D Plot Group**, type Temperature Countercurrent in the **Label** text field.
- 3 Locate the **Data** section. From the **Dataset** list, choose **Countercurrent mirror**.
- 4 Locate the **Title** section. From the **Title type** list, choose **None**.
- 5 Locate the **Plot Settings** section. Clear the **Plot dataset edges** checkbox.
- 6 Locate the **Color Legend** section. Select the **Show units** checkbox.

### *Surface 1*

- 1 In the **Temperature Countercurrent** toolbar, click  **Surface**.
- 2 In the **Settings** window for **Surface**, locate the **Expression** section.
- 3 In the **Expression** text field, type T\_tubes.
- 4 Locate the **Coloring and Style** section. From the **Color table** list, choose **ConopiformisZero**.
- 5 From the **Color table transformation** list, choose **Reverse**.

### *Temperature Countercurrent*

In the **Temperature Countercurrent** toolbar, click  **Slice**.

#### *Slice 1*

- 1 In the **Settings** window for **Slice**, locate the **Expression** section.
- 2 In the **Expression** text field, type T\_sr.
- 3 Click to expand the **Inherit Style** section. From the **Plot** list, choose **Surface 1**.

### *Temperature Countercurrent*

In the **Temperature Countercurrent** toolbar, click  **Surface**.

#### *Surface 2*

- 1 In the **Settings** window for **Surface**, locate the **Expression** section.
- 2 In the **Expression** text field, type 1.

#### *Selection 1*

- 1 In the **Temperature Countercurrent** toolbar, click  **Selection**.
- 2 Select Boundaries 9, 10, 12, and 26 only.

#### *Surface 2*

In the **Model Builder** window, click **Surface 2**.

### *Material Appearance 1*

- 1 In the **Temperature Countercurrent** toolbar, click  **Material Appearance**.
- 2 In the **Settings** window for **Material Appearance**, locate the **Appearance** section.
- 3 From the **Appearance** list, choose **Custom**.
- 4 From the **Material type** list, choose **Steel (anodized)**.

#### *Surface 3*

Right-click **Surface 2** and choose **Duplicate**.

#### *Selection 1*

- 1 In the **Model Builder** window, expand the **Surface 3** node, then click **Selection 1**.
- 2 In the **Settings** window for **Selection**, locate the **Selection** section.
- 3 Click  **Clear Selection**.
- 4 Select Boundary 11 only.

#### *Surface 3*

In the **Model Builder** window, click **Surface 3**.

### Transparency 1

- 1 In the **Temperature Countercurrent** toolbar, click  **Transparency**.
- 2 In the **Settings** window for **Transparency**, locate the **Transparency** section.
- 3 Find the **Transparency** subsection. In the **Transparency** text field, type 0.75.

### Temperature Countercurrent

In the **Temperature Countercurrent** toolbar, click  **Arrow Surface**.

### Arrow Surface 1

- 1 In the **Settings** window for **Arrow Surface**, click **Replace Expression** in the upper-right corner of the **Expression** section. From the menu, choose **Component 1 (comp1) > Heat Transfer in Porous Media in Bed > Domain fluxes > ht.tfluxx, ..., ht.tfluxz - Total heat flux**.
- 2 Locate the **Arrow Positioning** section. From the **Placement** list, choose **Uniform anisotropic**.
- 3 In the **Number of arrows** text field, type 150.
- 4 In the **z weight** text field, type 1.5.
- 5 Locate the **Coloring and Style** section. From the **Arrow base** list, choose **Center**.
- 6 Select the **Scale factor** checkbox. In the associated text field, type 3.6E-6.
- 7 From the **Color** list, choose **Gray**.

### Selection 1

- 1 In the **Temperature Countercurrent** toolbar, click  **Selection**.
- 2 Select Boundaries 2 and 7 only.

### Temperature Countercurrent

In the **Temperature Countercurrent** toolbar, click  **Arrow Surface**.

### Arrow Surface 2



In the **Settings** window for **Arrow Surface**, click **Replace Expression** in the upper-right corner of the **Expression** section. From the menu, choose **Component 1 (comp1) > Heat Transfer in Heating Tubes > Domain fluxes > ht2.tfluxx, ..., ht2.tfluxz - Total heat flux**.

### Selection 1

- 1 Right-click **Arrow Surface 2** and choose **Selection**.
- 2 Select Boundary 5 only.

### Arrow Surface 2

- 1 In the **Model Builder** window, click **Arrow Surface 2**.

- 2 In the **Settings** window for **Arrow Surface**, click **Replace Expression** in the upper-right corner of the **Expression** section. From the menu, choose **Component 1 (comp1) > Heat Transfer in Heating Tubes > Domain fluxes > ht2.tfluxx,...,ht2.tfluxz - Total heat flux**.
- 3 Locate the **Arrow Positioning** section. From the **Placement** list, choose **Uniform anisotropic**.
- 4 In the **Number of arrows** text field, type 40.
- 5 In the **x weight** text field, type 0.3.
- 6 In the **z weight** text field, type 3.
- 7 Locate the **Coloring and Style** section.
- 8 Select the **Scale factor** checkbox. In the associated text field, type 3E-8.
- 9 In the **Temperature Countercurrent** toolbar, click  **Plot**.
- 10 Click the  **Zoom Extents** button in the **Graphics** toolbar.  
This is [Figure 8\(a\)](#).

#### *Velocity Countercurrent*

- 1 In the **Home** toolbar, click  **Add Plot Group** and choose **3D Plot Group**.
- 2 In the **Settings** window for **3D Plot Group**, type **Velocity Countercurrent** in the **Label** text field.
- 3 Locate the **Data** section. From the **Dataset** list, choose **Countercurrent mirror**.
- 4 Locate the **Title** section. From the **Title type** list, choose **None**.
- 5 Locate the **Plot Settings** section. Clear the **Plot dataset edges** checkbox.
- 6 Locate the **Color Legend** section. Select the **Show units** checkbox.

#### *Volume 1*

- 1 In the **Velocity Countercurrent** toolbar, click  **Volume**.
- 2 In the **Settings** window for **Volume**, click **Replace Expression** in the upper-right corner of the **Expression** section. From the menu, choose **Default > spf.U - Velocity magnitude - m/s**.
- 3 Locate the **Coloring and Style** section. From the **Color table** list, choose **Cividis**.

#### *Selection 1*

- 1 In the **Velocity Countercurrent** toolbar, click  **Selection**.
- 2 In the **Settings** window for **Selection**, locate the **Selection** section.
- 3 From the **Selection** list, choose **Heating Tubes**.

### Velocity Countercurrent

In the **Velocity Countercurrent** toolbar, click  **Arrow Surface**.

#### Arrow Surface |

- 1 In the **Settings** window for **Arrow Surface**, locate the **Expression** section.
- 2 Click **u,v,w - Velocity field** in the upper-right corner of the section.
- 3 Locate the **Arrow Positioning** section. From the **Placement** list, choose **Uniform anisotropic**.
- 4 In the **Number of arrows** text field, type 40.
- 5 In the **x weight** text field, type 0.4.
- 6 In the **z weight** text field, type 4.
- 7 Locate the **Coloring and Style** section. From the **Arrow type** list, choose **Arrowhead**.
- 8 From the **Color** list, choose **White**.

#### Selection |

- 1 In the **Velocity Countercurrent** toolbar, click  **Selection**.
- 2 In the **Settings** window for **Selection**, locate the **Selection** section.
- 3 From the **Selection** list, choose **Tubes Symmetry**.

### Velocity Countercurrent

In the **Velocity Countercurrent** toolbar, click  **Arrow Volume**.

#### Arrow Volume |

- 1 In the **Settings** window for **Arrow Volume**, click **Replace Expression** in the upper-right corner of the **Expression** section. From the menu, choose **Component I (comp I) > Darcy's Law in Bed > Velocity and pressure > dl.u,dl.v,dl.w - Total Darcy velocity field**.
- 2 Locate the **Coloring and Style** section. From the **Arrow length** list, choose **Normalized**.

#### Color Expression |

- 1 In the **Velocity Countercurrent** toolbar, click  **Color Expression**.
- 2 In the **Settings** window for **Color Expression**, click **Replace Expression** in the upper-right corner of the **Expression** section. From the menu, choose **Component I (comp I) > Darcy's Law in Bed > Velocity and pressure > dl.U - Total Darcy velocity magnitude - m/s**.

### Velocity Countercurrent

In the **Velocity Countercurrent** toolbar, click  **Surface**.

#### Surface |

- 1 In the **Settings** window for **Surface**, locate the **Expression** section.

2 In the **Expression** text field, type 1.



#### *Material Appearance 1*

- 1 In the **Velocity Countercurrent** toolbar, click  **Material Appearance**.
- 2 In the **Settings** window for **Material Appearance**, locate the **Appearance** section.
- 3 From the **Appearance** list, choose **Custom**.
- 4 From the **Material type** list, choose **Steel (anodized)**.

#### *Surface 1*

In the **Model Builder** window, click **Surface 1**.

#### *Selection 1*

- 1 In the **Velocity Countercurrent** toolbar, click  **Selection**.
- 2 Select Boundaries 9–12 only.
- 3 In the **Velocity Countercurrent** toolbar, click  **Plot**.

**CO-CURRENT T\_IN\_TUBES = 900, 1000 K**

Now, switch to co-current flow by changing the selections for the inlets and outlets of the heating tubes.

In the **Study** toolbar, click  **Compute**.

## **RESULTS**

#### *Co-current mirror*

- 1 In the **Model Builder** window, right-click **Countercurrent mirror** and choose **Duplicate**.
- 2 In the **Settings** window for **Mirror 3D**, type Co-current mirror in the **Label** text field.
- 3 Locate the **Data** section. From the **Dataset** list, choose **Co-current T\_in\_tubes = 900, 1000 K/Parametric Solutions 1 (sol7)**.

Duplicate the figures from the countercurrent case and plot data from the co-current case with T\_in\_tubes = 1000 K.

*Concentration, H2 Countercurrent, Countercurrent Mass Fractions, Gas Density, Countercurrent 900 K, Mass fraction, C3H8 Countercurrent, Temperature Countercurrent, Velocity Countercurrent*



- 1 In the **Model Builder** window, under **Results**, Ctrl-click to select **Countercurrent Mass Fractions, Mass fraction, C3H8 Countercurrent, Concentration, H2 Countercurrent, Gas Density, Countercurrent 900 K, Temperature Countercurrent, and Velocity Countercurrent**.

- 2 Right-click and choose **Duplicate**.

#### *Co-current Mass Fractions, 1000 K*

- 1 In the **Settings** window for **ID Plot Group**, type Co-current Mass Fractions, 1000 K in the **Label** text field.
- 2 Locate the **Data** section. From the **Dataset** list, choose **Co-current T\_in\_tubes = 900, 1000 K/Parametric Solutions I (sol7)**.
- 3 From the **Parameter selection (T\_in\_tubes)** list, choose **Last**.
- 4 Locate the **Legend** section. From the **Position** list, choose **Upper right**.
- 5 In the **Co-current Mass Fractions, 1000 K** toolbar, click  **Plot**.



#### *Mass fraction, C3H8 Co-current 1000 K*

- 1 In the **Model Builder** window, under **Results** click **Mass fraction, C3H8 Countercurrent I**.
- 2 In the **Settings** window for **3D Plot Group**, type Mass fraction, C3H8 Co-current 1000 K in the **Label** text field.
- 3 Locate the **Data** section. From the **Dataset** list, choose **Co-current mirror**.
- 4 In the **Mass fraction, C3H8 Co-current 1000 K** toolbar, click  **Plot**.
- 5 In the **Graphics** window toolbar, click  next to  **Scene Light**, then choose **Ambient Occlusion**.

#### *Concentration, H2 Co-current 1000 K*



- 1 In the **Model Builder** window, under **Results** click **Concentration, H2 Countercurrent I**.
- 2 In the **Settings** window for **3D Plot Group**, type Concentration, H2 Co-current 1000 K in the **Label** text field.
- 3 Locate the **Data** section. From the **Dataset** list, choose **Co-current mirror**.
- 4 In the **Concentration, H2 Co-current 1000 K** toolbar, click  **Plot**.

#### *Gas Density, Co-current 1000 K*



- 1 In the **Model Builder** window, under **Results** click **Gas Density, Countercurrent 900 K I**.
- 2 In the **Settings** window for **3D Plot Group**, type Gas Density, Co-current 1000 K in the **Label** text field.
- 3 Locate the **Data** section. From the **Dataset** list, choose **Co-current mirror**.
- 4 In the **Gas Density, Co-current 1000 K** toolbar, click  **Plot**.
- 5 Click the  **Zoom Extents** button in the **Graphics** toolbar.

#### *Temperature, Co-current 1000 K*

- 1 In the **Model Builder** window, under **Results** click **Temperature Countercurrent I**.

- 2 In the **Settings** window for **3D Plot Group**, type Temperature, Co-current 1000 K in the **Label** text field.
- 3 Locate the **Data** section. From the **Dataset** list, choose **Co-current mirror**.
- 4 Click to expand the **Number Format** section. Select the **Manual color legend settings** checkbox.
- 5 In the **Precision** text field, type 4.
- 6 In the **Temperature, Co-current 1000 K** toolbar, click  **Plot**.
- 7 Click the  **Zoom Extents** button in the **Graphics** toolbar.  
This is [Figure 8](#) (b).

*Velocity Co-current, 1000 K*

- 1 In the **Model Builder** window, under **Results** click **Velocity Countercurrent 1**.
- 2 In the **Settings** window for **3D Plot Group**, type Velocity Co-current, 1000 K in the **Label** text field.
- 3 Locate the **Data** section. From the **Dataset** list, choose **Co-current mirror**.
- 4 In the **Velocity Co-current, 1000 K** toolbar, click  **Plot**.
- 5 Click the  **Zoom Extents** button in the **Graphics** toolbar.  
This is [Figure 9](#).

*Concentration, H2 Countercurrent, Countercurrent Mass Fractions, Gas Density, Countercurrent 900 K, Mass fraction, C3H8 Countercurrent, Temperature Countercurrent, Velocity Countercurrent, w\_C3H8 and T at L/2*

- 1 In the **Model Builder** window, under **Results**, Ctrl-click to select **w\_C3H8 and T at L/2**, **Countercurrent Mass Fractions**, **Mass fraction, C3H8 Countercurrent**, **Concentration**, **H2 Countercurrent**, **Gas Density**, **Countercurrent 900 K**, **Temperature Countercurrent**, and **Velocity Countercurrent**.
- 2 Right-click and choose **Group**.

*Countercurrent, 900 K*

In the **Settings** window for **Group**, type Countercurrent, 900 K in the **Label** text field.

*Co-current Mass Fractions, 1000 K, Concentration, H2 Co-current 1000 K, Gas Density, Co-current 1000 K, Mass fraction, C3H8 Co-current 1000 K, Temperature, Co-current 1000 K, Velocity Co-current, 1000 K*

- 1 In the **Model Builder** window, under **Results**, Ctrl-click to select **Co-current Mass Fractions, 1000 K**, **Mass fraction, C3H8 Co-current 1000 K**, **Concentration**,

**H2 Co-current 1000 K, Gas Density, Co-current 1000 K, Temperature, Co-current 1000 K,**  
and **Velocity Co-current, 1000 K.**

2 Right-click and choose **Group**.

*Co-current, 1000 K*

In the **Settings** window for **Group**, type Co-current, 1000 K in the **Label** text field.

*w\_C3H8 and w\_CO Along Bed Midline*

Now, plot mass fractions of C3H8 and CO for the three solutions (design cases) in the same plot. Use two y-axes to better visualize the results. When done this will give [Figure 6](#).

1 In the **Results** toolbar, click  **ID Plot Group**.

2 In the **Settings** window for **ID Plot Group**, type w\_C3H8 and w\_CO Along Bed Midline in the **Label** text field.

3 Locate the **Title** section. From the **Title type** list, choose **None**.

*C3H8 countercurrent 900 K*

1 Right-click **w\_C3H8 and w\_CO Along Bed Midline** and choose **Line Graph**.

2 In the **Settings** window for **Line Graph**, type C3H8 countercurrent 900 K in the **Label** text field.

3 Locate the **Data** section. From the **Dataset** list, choose **Countercurrent T\_in\_tubes = 900K/Solution 1 (sol1)**.

4 Select Edge 3 only.

5 Locate the **y-Axis Data** section. In the **Expression** text field, type w\_C3H8.

6 Locate the **x-Axis Data** section. From the **Parameter** list, choose **Expression**.

7 In the **Expression** text field, type x.

8 Locate the **Legends** section. Select the **Show legends** checkbox.

9 Find the **Include** subsection. Select the **Label** checkbox.

10 Clear the **Solution** checkbox.

*C3H8 Co-current 900 K*

1 Right-click **C3H8 countercurrent 900 K** and choose **Duplicate**.

2 In the **Settings** window for **Line Graph**, type C3H8 Co-current 900 K in the **Label** text field.

3 Locate the **Data** section. From the **Dataset** list, choose **Co-current T\_in\_tubes = 900, 1000 K/Parametric Solutions 1 (sol7)**.

4 From the **Parameter selection (T\_in\_tubes)** list, choose **First**.

#### *C3H8 Co-current 1000 K*

- 1 Right-click **C3H8 Co-current 900 K** and choose **Duplicate**.
- 2 In the **Settings** window for **Line Graph**, type C3H8 Co-current 1000 K in the **Label** text field.
- 3 Locate the **Data** section. From the **Parameter selection (T\_in\_tubes)** list, choose **Last**.
- 4 In the **w\_C3H8 and w\_CO Along Bed Midline** toolbar, click  **Plot**.

#### *C3H8 Co-current 1000 K, C3H8 Co-current 900 K, C3H8 countercurrent 900 K*

- 1 In the **Model Builder** window, under **Results > w\_C3H8 and w\_CO Along Bed Midline**, Ctrl-click to select **C3H8 countercurrent 900 K**, **C3H8 Co-current 900 K**, and **C3H8 Co-current 1000 K**.
- 2 Right-click and choose **Duplicate**.

#### *CO countercurrent 900 K*

- 1 In the **Settings** window for **Line Graph**, type CO countercurrent 900 K in the **Label** text field.
- 2 Locate the **y-Axis Data** section. In the **Expression** text field, type w\_CO.
- 3 Click to expand the **Coloring and Style** section. Find the **Line style** subsection. From the **Line** list, choose **Dashed**.
- 4 From the **Color** list, choose **Cycle (reset)**.

#### *CO Co-current 900 K*



- 1 In the **Model Builder** window, under **Results > w\_C3H8 and w\_CO Along Bed Midline** click **C3H8 Co-current 900 K I**.
- 2 In the **Settings** window for **Line Graph**, type CO Co-current 900 K in the **Label** text field.
- 3 Locate the **y-Axis Data** section. In the **Expression** text field, type w\_CO.
- 4 Locate the **Coloring and Style** section. Find the **Line style** subsection. From the **Line** list, choose **Dashed**.

#### *CO Co-current 1000 K*

- 1 In the **Model Builder** window, under **Results > w\_C3H8 and w\_CO Along Bed Midline** click **C3H8 Co-current 1000 K I**.
- 2 In the **Settings** window for **Line Graph**, type CO Co-current 1000 K in the **Label** text field.
- 3 Locate the **y-Axis Data** section. In the **Expression** text field, type w\_CO.

- 4 Locate the **Coloring and Style** section. Find the **Line style** subsection. From the **Line** list, choose **Dashed**.

#### *w\_C3H8 and w\_CO Along Bed Midline*

- 1 In the **Model Builder** window, click **w\_C3H8 and w\_CO Along Bed Midline**.
- 2 In the **Settings** window for **ID Plot Group**, locate the **Plot Settings** section.
- 3 Select the **x-axis label** checkbox.
- 4 Select the **y-axis label** checkbox. In the associated text field, type Mass fraction C3H8.
- 5 Select the **Two y-axes** checkbox.
- 6 Select the **Secondary y-axis label** checkbox. In the associated text field, type Mass fraction CO.
- 7 In the table, select the **Plot on secondary y-axis** checkboxes for **CO countercurrent 900 K**, **CO Co-current 900 K**, and **CO Co-current 1000 K**.
- 8 In the **w\_C3H8 and w\_CO Along Bed Midline** toolbar, click  **Plot**.
- 9 Locate the **Legend** section. From the **Position** list, choose **Middle right**.
- 10 In the **w\_C3H8 and w\_CO Along Bed Midline** toolbar, click  **Plot**.
- 11 Click the  **Zoom Extents** button in the **Graphics** toolbar.

This is [Figure 6](#).

Now plot the temperature profiles along the bed centerline and along the side of one of the heating tubes. Utilize the plot group just created by duplicating it and modify the expressions and legends accordingly.

#### *Temperature Profiles Along Reactor*

- 1 Right-click **w\_C3H8 and w\_CO Along Bed Midline** and choose **Duplicate**.
- 2 In the **Settings** window for **ID Plot Group**, type Temperature Profiles Along Reactor in the **Label** text field.

#### *T\_sr countercurrent 900 K*

- 1 In the **Model Builder** window, expand the **Temperature Profiles Along Reactor** node, then click **C3H8 countercurrent 900 K**.
- 2 In the **Settings** window for **Line Graph**, type T\_sr countercurrent 900 K in the **Label** text field.
- 3 Locate the **y-Axis Data** section. In the **Expression** text field, type T\_sr.

#### *T<sub>sr</sub> Co-current 900 K*

- 1 In the **Model Builder** window, under **Results > Temperature Profiles Along Reactor** click **C3H8 Co-current 900 K**.
- 2 In the **Settings** window for **Line Graph**, type *T<sub>sr</sub> Co-current 900 K* in the **Label** text field.
- 3 Locate the **y-Axis Data** section. In the **Expression** text field, type *T<sub>sr</sub>*.

#### *T<sub>sr</sub> Co-current 1000 K*

- 1 In the **Model Builder** window, under **Results > Temperature Profiles Along Reactor** click **C3H8 Co-current 1000 K**.
- 2 In the **Settings** window for **Line Graph**, type *T<sub>sr</sub> Co-current 1000 K* in the **Label** text field.
- 3 Locate the **y-Axis Data** section. In the **Expression** text field, type *T<sub>sr</sub>*.

#### *T<sub>tubes</sub> countercurrent*



- 1 In the **Model Builder** window, under **Results > Temperature Profiles Along Reactor** click **CO countercurrent 900 K**.
- 2 In the **Settings** window for **Line Graph**, type *T<sub>tubes</sub> countercurrent* in the **Label** text field.
- 3 Locate the **Selection** section. Click to select the  **Activate Selection** toggle button.
- 4 Select Edge 6 only.
- 5 Locate the **y-Axis Data** section. In the **Expression** text field, type *T<sub>tubes</sub>*.

#### *T<sub>tubes</sub> Co-current 900 K*



- 1 In the **Model Builder** window, under **Results > Temperature Profiles Along Reactor** click **CO Co-current 900 K**.
- 2 In the **Settings** window for **Line Graph**, type *T<sub>tubes</sub> Co-current 900 K* in the **Label** text field.
- 3 Locate the **Selection** section. Click to select the  **Activate Selection** toggle button.
- 4 Select Edge 6 only.
- 5 Locate the **y-Axis Data** section. In the **Expression** text field, type *T<sub>tubes</sub>*.

#### *T<sub>tubes</sub> Co-current 1000 K*

- 1 In the **Model Builder** window, under **Results > Temperature Profiles Along Reactor** click **CO Co-current 1000 K**.
- 2 In the **Settings** window for **Line Graph**, type *T<sub>tubes</sub> Co-current 1000 K* in the **Label** text field.

- 3 Locate the **Selection** section. Click to select the  **Activate Selection** toggle button.
- 4 Select Edge 6 only.
- 5 Locate the **y-Axis Data** section. In the **Expression** text field, type T\_tubes.
- 6 In the **Temperature Profiles Along Reactor** toolbar, click  **Plot**.

#### *Temperature Profiles Along Reactor*

- 1 In the **Model Builder** window, click **Temperature Profiles Along Reactor**.
- 2 In the **Settings** window for **ID Plot Group**, locate the **Plot Settings** section.
- 3 Clear the **Two y-axes** checkbox.
- 4 In the **y-axis label** text field, type Temperature (K).
- 5 In the **Temperature Profiles Along Reactor** toolbar, click  **Plot**.
- 6 Locate the **Legend** section. From the **Position** list, choose **Upper middle**.
- 7 Click the  **Zoom Extents** button in the **Graphics** toolbar.

This is [Figure 7](#).

Finally, calculate the average outlet temperatures for the gas in the heating tubes and in the reformer bed.

#### *Average temperature in bed outflow*

- 1 In the **Results** toolbar, click  **Global Evaluation**.
- 2 In the **Settings** window for **Global Evaluation**, type Average temperature in bed outflow in the **Label** text field.
- 3 Locate the **Data** section. From the **Dataset** list, choose **Co-current T\_in\_tubes = 900, 1000 K/Parametric Solutions 1 (sol7)**.
- 4 From the **Parameter selection (T\_in\_tubes)** list, choose **Last**.
- 5 Locate the **Expressions** section. In the table, enter the following settings:

Expression	Unit	Description
ht.of11.Tave	K	Weighted average temperature

- 6 Click  **Evaluate**.

#### *Average temperature in heat tube outflow*

- 1 In the **Results** toolbar, click  **Global Evaluation**.
- 2 In the **Settings** window for **Global Evaluation**, type Average temperature in heat tube outflow in the **Label** text field.

- 3 Locate the **Data** section. From the **Dataset** list, choose **Co-current T\_in\_tubes = 900, 1000 K/Parametric Solutions 1 (sol7)**.
- 4 From the **Parameter selection (T\_in\_tubes)** list, choose **Last**.
- 5 Locate the **Expressions** section. In the table, enter the following settings:

Expression	Unit	Description
ht2.of12.Tave	K	Weighted average temperature

- 6 Click  **Evaluate**.