



Model created in COMSOL Multiphysics 6.4

Transport in an Electrokinetic Valve

Introduction

This tutorial presents an example of pressure-driven flow and electrophoresis in a microchannel system.

Researchers often use a device similar to the one in this example as an electrokinetic sample injector in biochips to obtain well-defined sample volumes of dissociated acids and salts and to transport these volumes. The model presents a study of a pinched injection cross valve during the focusing, injection, and separation stages. Inspiration for the model comes from a study by Ermakov and others ([Ref. 1](#)). Focusing is obtained through pressure-driven flow of the sample and buffer solution, which confines the sample in the focusing channel. When the system reaches steady state, the pressure-driven flow is turned off and an electric field is applied along the channels. This field drives the dissociated sample ions in the focusing zone at right angles to the focusing channel and through the injection channel. A clean separation of the sample ions is important, so the model examines the effect on ion separation of different configurations of the electric field.

This specific case does not account for electroosmosis because the channel surfaces are subjected to a treatment that minimizes the extension of the electric double layer.

Note: This model requires either the CFD Module, the Microfluidics Module, or the Subsurface Flow Module

Model Definition

[Figure 1](#) shows a 2D cross section of the geometry in the xz -plane and points out the different channels and boundaries. The horizontal channel serves as the focusing channel, while the vertical channel is the injection channel. The actual model is in 3D with rectangular pipes whose corners are rounded. For geometry dimensions refer to [Table 1](#) below.

TABLE 1: MODEL DIMENSIONS.

| | HORIZONTAL CHANNEL | VERTICAL CHANNEL | CROSSING AREA |
|------------------------------|--------------------|------------------|---------------|
| Dimensions (μm) | | | |
| - x | 340 | 20 | 28 |
| - y | 20 | 20 | 20 |
| - z | 20 | 340 | 28 |
| Position (μm) | | | |

TABLE I: MODEL DIMENSIONS.

| | HORIZONTAL CHANNEL | VERTICAL CHANNEL | CROSSING AREA |
|----------------------------|--------------------|------------------|---------------|
| - x | -100 | 0 | -4 |
| - y | 0 | 0 | 0 |
| - z | 0 | -200 | -4 |
| Rounding (μm) | | | |
| - radius | 4 | 4 | 4 |
| - direction | in | in | out |

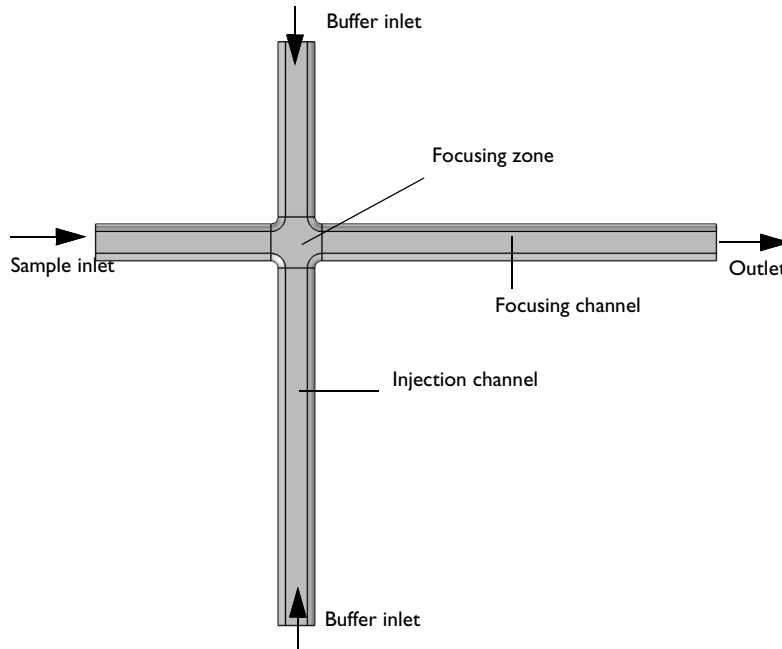

Figure 1: The focusing stage involves pressure-driven flow of both the sample and the buffering solution. The device applies an electric field over the focusing channel.

The device operation and hence the modeling procedure takes place in two stages: focusing and injection.

In the focusing stage, the device injects a buffering solution through pressure-driven convection into the vertical channels from the top and bottom. At the same time, it forces the sample solution through the horizontal focusing channel (see [Figure 1](#)). The buffering solution neutralizes the acids contained in the sample except for a very thin region

confined to the crossing between the horizontal and vertical channels. This means that the dissociated ions are only in a needle-shaped region in the focusing zone.

Next, in the injection stage the device turns off the convective flow and then applies a vertical field to migrate the sample from the focusing channel to the injection point at the lower end of the vertical channel. The sample ions are negatively charged and migrate in opposite direction to the electric field. This model studies two different configurations (See Table 2) for the applied electric field. In the first configuration (Injection stage, Mode A) electric field is only applied in the vertical direction. In the second configuration (Injection stage, Mode B) the electric field is applied in both the horizontal and vertical directions (Figure 2). The horizontal field focuses the sample during the initial part of the injection stage in order to obtain a well-separated sample.

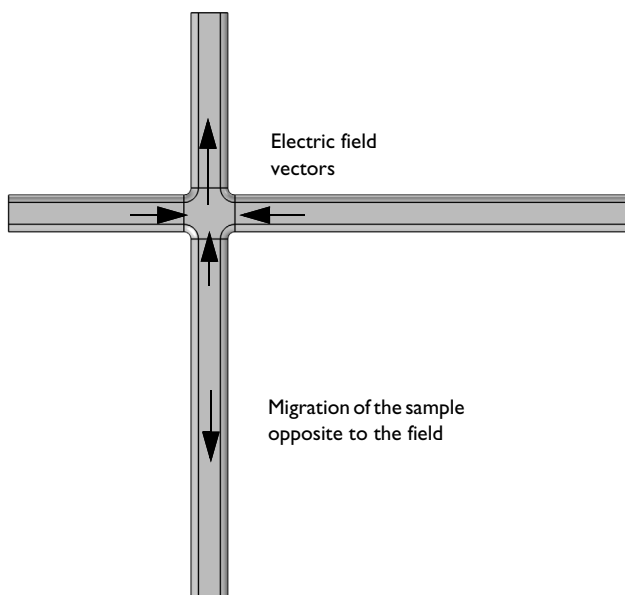

Figure 2: During the injection stage, the device turns off convective flow and applies an electric field. The horizontal field avoids the broadening of the sample, while the vertical field injects the sample into the vertical channel in the direction opposite to the electric field.

TABLE 2: APPLIED ELECTRIC FIELD CONFIGURATION.

| INLET | FOCUSING STAGE | INJECTION STAGE, MODE A | INJECTION STAGE, MODE B |
|--------------------|-------------------------------|---------------------------------|---------------------------------|
| Sample inlet | Electric potential, $V = -1V$ | Electric insulation | Electric potential, $V = -1V$ |
| Outlet | Ground | Electric insulation | Ground |
| Upper buffer inlet | Electric insulation | Electric potential, $V = -3.2V$ | Electric potential, $V = -3.2V$ |
| Lower buffer inlet | Electric insulation | Ground | Ground |

The model assumes that the charged sample concentration is very low compared to other ions dissolved in the solution. This implies that the sample concentration does not influence the solution's conductivity and that you can neglect the concentration gradients of the charge-carrying species, which are present in a much higher concentration than the sample ions. Such an electrolyte is known as a supporting electrolyte.

Several equations describe the model: the Stokes flow equations, the equation for current balance, and a mass balance using the Nernst–Planck equation. This model uses the steady-state solution for the focusing stage as the initial condition for the injection stages.

Now consider the formulation of the model equations.

THE FOCUSING STAGE

The Stokes flow equations give the global mass and momentum balance in the focusing stage:

$$0 = \nabla \cdot [-p\mathbf{I} + \eta(\nabla\mathbf{u} + (\nabla\mathbf{u})^T)]$$

$$\nabla \cdot \mathbf{u} = 0.$$

In these equations, η denotes the dynamic viscosity (SI unit: kg/(m·s)), \mathbf{u} is the velocity (SI unit: m/s), p is the pressure (SI unit: Pa).

The total balance of charges for a supporting electrolyte comes from the divergence of the current-density vector, which in a supporting electrolyte is given by Ohm's law:

$$\mathbf{i} = -\kappa\nabla V$$

Here κ is the electrolyte's conductivity (SI unit: S/m) and V is the potential (SI unit: V). The balance of current at steady state then becomes

$$\nabla \cdot \mathbf{i} = 0$$

which gives

$$\nabla \cdot (-\kappa \nabla V) = 0$$

The flux vector for the sample ions comes from the Nernst–Planck equation

$$\mathbf{N}_i = -D_i \nabla c_i - z_i u_{mi} F c_i \nabla V + c_i \mathbf{u}$$

which leads to the following mass balance equation at steady state for species i :

$$\nabla \cdot (-D_i \nabla c_i - z_i u_{mi} F c_i \nabla V + c_i \mathbf{u}) = 0$$

Here c_i is the concentration (SI unit: mol/m³), D_i represents the diffusivity (SI unit: m²/s), z_i equals the charge number (which equals 1 for this model), u_{mi} is the mobility (SI unit: s·mol/kg), and F is Faraday’s constant (SI unit: C/mol).

For the pressure-driven flow, assume that the flow has fully developed laminar form in all inlets, that all sides have no slip conditions, and that the fluid flows freely out from the end of the focusing channel.

The boundary conditions for the charge balance determine the potential at the respective inlet and outlet boundary

$$V = V_{0,i}$$

where i denotes the index for each boundary. This model also assumes that all wall boundaries are insulating:

$$\nabla V \cdot \mathbf{n} = 0$$

The boundary conditions for the mass balance of the sample during the focusing stage appear below. The equation

$$c = c_{\text{in}}$$

gives the concentration at the inlet of the sample, while the equation

$$c = c_{\text{buffer}}$$

gives the concentration of the buffer at both boundaries of the vertical channel. At the outlet boundary, convection and migration are the dominating transport mechanisms (that is, diffusion is negligible), so that

$$\mathbf{N}_i \cdot \mathbf{n} = (-z_i u_{mi} F c_i \nabla V + c_i \mathbf{u}) \cdot \mathbf{n}$$

THE INJECTION STAGE

In the injection and separation stages, the device turns the flow off and changes the configuration of the electric field. You again solve the charge-balance equations but with new boundary conditions:

$$\nabla \cdot (-\kappa \nabla V) = 0$$

The mass balance for the dilute species comes from a time-dependent mass balance:

$$\frac{\partial c_i}{\partial t} + \nabla \cdot (-D_i \nabla c_i - z_i u_{mi} F c_i \nabla V) = 0$$

The model assumes that the convective contribution is zero.

The boundary conditions for the current-balance equation imply that the potential is locked at all boundaries except for the walls,

$$V = V_{0,i}$$

Further assume the walls are electrically insulated, which yields

$$\nabla V \cdot \mathbf{n} = 0$$

As opposed to the focusing state, the boundary conditions for the mass balance are changed. In the injection stage, set the concentration at the inlet boundary:

$$c = c_{\text{in}}$$

For all other boundaries, assume that migration is the dominating transport mechanism, so that:

$$\mathbf{N}_i \cdot \mathbf{n} = (-z_i u_{mi} F c_i \nabla V) \cdot \mathbf{n}$$

The time-dependent solution requires an initial condition for the mass balance, which you obtain from the steady-state solution of the focusing stage:

$$c(t = 0) = c_{\text{focus}}$$

Results and Discussion

This example analyzes the focusing stage and two configurations for the injection stages. Recall that the first injection-stage configuration (Mode A) applies the electric field only over the injection channel while the inlet and outlet boundaries of the focusing channel

are insulated; the second injection-stage configuration (Mode B) applies the electric field over both channels.

Figure 3 shows the steady-state concentration distribution during the focusing stage along with the distribution at the beginning of the injection stage. Note that the vertical flows from the upper and lower injection channels focus the concentration on a very narrow region near the crossing area of the channels. Further away from the crossing area, however, the concentration spreads again more equally over the channel.

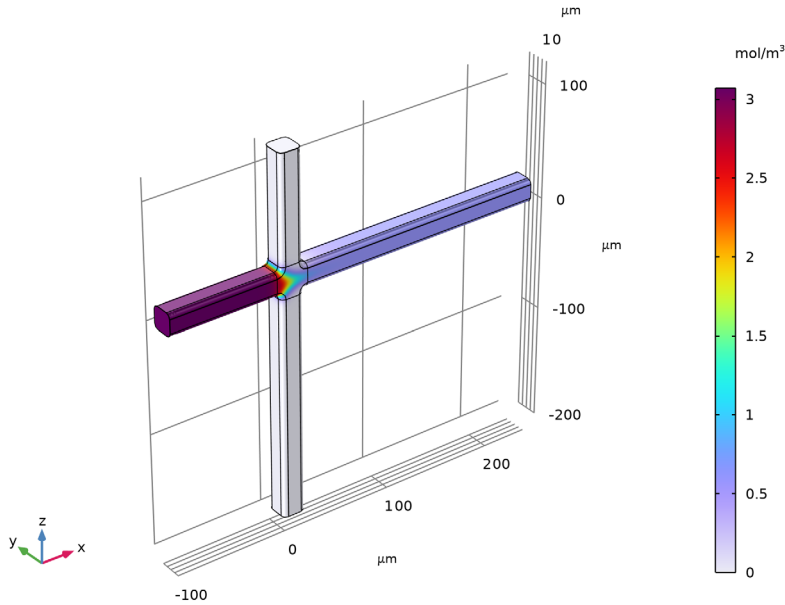

Figure 3: The steady-state concentration distribution during the focusing stage and prior to the injection stage.

Figure 4 and Figure 5 compare the concentration distribution for the two configurations at two times, specifically 0.06 s and 0.12 s after the beginning of the injection stage. The figures on the left show that the concentration boundary for Mode A is practically stationary in the horizontal direction. Consequently, the vertical electric field can continuously draw ions from the focusing channel, which results in poor separation and a poorly defined sample volume of the substance. For Mode B, the situation is very different. The horizontal electric field draws the concentration boundary to the left, and the

channels separate rapidly. Consequently, this scheme draws a well-defined sample volume of the substance into the injection channel.

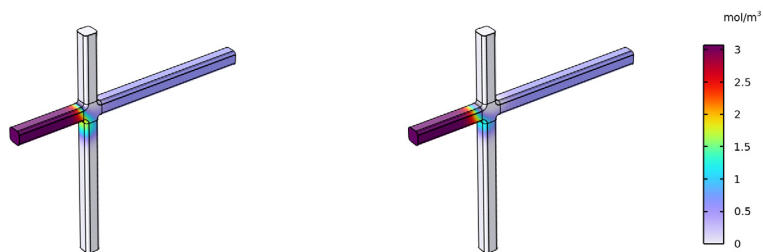

Figure 4: The concentration distribution at a time 0.06 s after starting the injection stage for the Mode A configuration (left) and Mode B configuration (right).

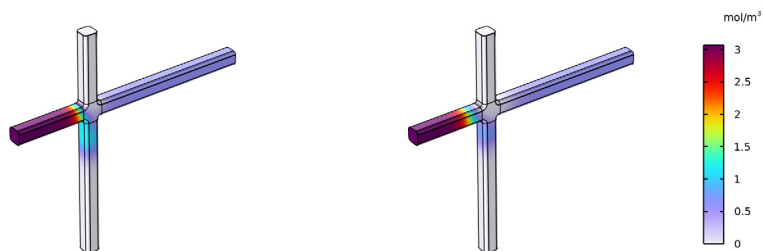

Figure 5: The concentration distribution at a time 0.12 s after starting the injection stage for the Mode A configuration (left) and Mode B configuration (right).

It is also possible to observe the difference between the two configurations if you look at the concentration along a line through the middle of the injection channel, examining it at several times after the start of the injection stage (Figure 6). The maximum concentration moves down the injection channel with time. The peaks are higher in the upper axis corresponding to Mode A, but they are much wider than for Mode B. A considerable amount of concentration appears at the left of the peak, and the sample remains attached to the focusing area — resulting in an unwanted distortion of the sample package. The narrow peaks of Mode B, on the other hand, form nice bell curves

throughout the downward transport in the injection channel, resulting in a well-defined sample package.

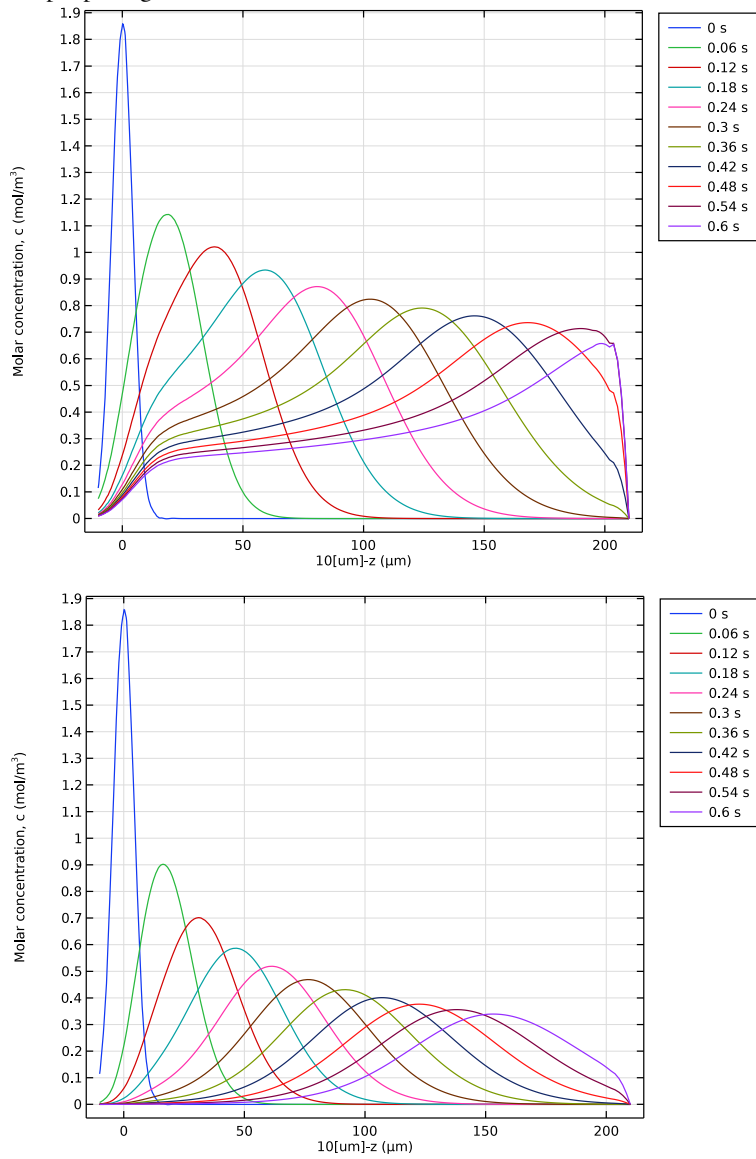

Figure 6: Concentration profile for Mode A (top) and Mode B (bottom) along the injection channel at various time steps: 0 s, 0.06 s, 0.12 s, 0.18 s, 0.24 s, 0.30 s, 0.36 s, 0.42 s, 0.48 s,

0.54 s, and 0.6 s after initialization of the injection stage. The origin of the x-axis marks the centerline of the focusing channel.

This study illustrates that modeling is extremely valuable in the investigation of electrophoretic transport. You can vary the configuration of the potential to obtain even better focusing and injection stages for the valve under study.

Notes About the COMSOL Implementation

INTERFACES

In COMSOL Multiphysics you define the model with the following physics interfaces:

- The Creeping Flow interface solves the fluid flow in the channels governed by Stokes equations.
- The Electric Currents interface solves the equation for current balance.
- The Transport of Diluted Species interface solves the Nernst–Planck equation.

COMPUTING THE SOLUTION

The operation of the actual device proceeds in two stages, the focusing stage and the injection stage. This model simulates two settings of the injection stage so in total it works in three phases.

The first phase defines the domain settings and boundary conditions for the focusing phase. Then the model solves the interfaces sequentially with a nonlinear solver in the following sequence:

- 1 Creeping Flow interface
- 2 Electric Currents interface
- 3 Transport of Diluted Species interface

Each step uses the solution from the previous one. The model stores the last solution for use as the initial value for the consequent modeling.

In the second phase you change the domain settings and boundary conditions to handle the injection stage Mode A. In a real device you would turn off the convective flow; in the model you simulate this by setting the velocity parameters of the Electrokinetic Flow interface to zero. Thus it uses no information from the Laminar Flow interface.

Solving the second phase starts from the stored solution of the first phase, and the model solves the Electric Currents interface with a nonlinear solver. Then you select a time-

dependent solver and solve the Transport of Diluted Species interface. This solution is the result for the injection stage Mode A.

In the third phase you again change domain settings and boundary conditions but this time for the injection stage Mode B; you then solve for the final solution the same way as in the second phase.

Reference

1. S.V. Ermakov, S.C. Jacobson, and J.M. Ramsey, *Technical Proc 1999 Int. Conf. on Modeling and Simulation of Microsystems*, Computational Publications, 1999.

Application Library path: Chemical_Reaction_Engineering_Module/
Electrokinetic_Effects/electrokinetic_valve



Modeling Instructions

From the **File** menu, choose **New**.

NEW

In the **New** window, click  **Model Wizard**.

MODEL WIZARD

- 1 In the **Model Wizard** window, click .
- 2 In the **Select Physics** tree, select **AC/DC** > **Electric Fields and Currents** > **Electric Currents (ec)**.
- 3 Click **Add**.
- 4 In the **Select Physics** tree, select **Chemical Species Transport** > **Transport of Diluted Species (tds)**.
- 5 Click **Add**.
- 6 In the **Select Physics** tree, select **Fluid Flow** > **Single-Phase Flow** > **Creeping Flow (spf)**.
- 7 Click **Add**.
- 8 Click  **Study**.
- 9 In the **Select Study** tree, select **General Studies** > **Stationary**.
- 10 Click  **Done**.

GLOBAL DEFINITIONS

Add the model parameters from a text file.

Parameters 1

- 1 In the **Model Builder** window, under **Global Definitions** click **Parameters 1**.
- 2 In the **Settings** window for **Parameters**, locate the **Parameters** section.
- 3 Click  **Load from File**.
- 4 Browse to the model's Application Libraries folder and double-click the file `electrokinetic_valve_parameters.txt`.

GEOMETRY 1

Import the geometry.

- 1 In the **Geometry** toolbar, click **Insert Sequence** and choose **Insert Sequence**.
- 2 Browse to the model's Application Libraries folder and double-click the file `electrokinetic_valve_geom_sequence.mph`.
- 3 In the **Geometry** toolbar, click  **Build All**.

Use the **Materials** node to make your own electrolyte fluid material.

MATERIALS

Electrolyte Fluid

- 1 In the **Model Builder** window, under **Component 1 (comp1)** right-click **Materials** and choose **Blank Material**.
- 2 In the **Settings** window for **Material**, type `Electrolyte Fluid` in the **Label** text field.
- 3 Locate the **Material Contents** section. In the table, enter the following settings:

| Property | Variable | Value | Unit | Property group |
|-----------------------|---|--------------------------|-------------------|----------------|
| Electric conductivity | <code>sigma_iso ; sigma_ii = sigma_iso, sigma_ij = 0</code> | 1 [S/m] | S/m | Basic |
| Relative permittivity | <code>epsilon_lr_iso ; epsilon_lr_ii = epsilon_lr_iso, epsilon_lr_ij = 0</code> | 1 | 1 | Basic |
| Density | <code>rho</code> | 1e3 [kg/m ³] | kg/m ³ | Basic |
| Dynamic viscosity | <code>mu</code> | 1e-3 [Pa*s] | Pa*s | Basic |

Choose all the necessary features in the interfaces to model the focusing stage and injection stages for both mode A and B. Later in the study node, you can select which of the features that are solved for.

ELECTRIC CURRENTS (EC)

Electric Potential - Focusing Stage and Injection Stage Mode B

- 1 In the **Physics** toolbar, click  **Boundaries** and choose **Electric Potential**.
- 2 In the **Settings** window for **Electric Potential**, type Electric Potential - Focusing Stage and Injection Stage Mode B in the **Label** text field.
- 3 Locate the **Boundary Selection** section. From the **Selection** list, choose **Sample Inlet**.
- 4 Locate the **Electric Potential** section. In the V_0 text field, type V_{appS} .

Ground - Focusing Stage and Injection Stage Mode B

- 1 In the **Physics** toolbar, click  **Boundaries** and choose **Ground**.
- 2 In the **Settings** window for **Ground**, type Ground - Focusing Stage and Injection Stage Mode B in the **Label** text field.
- 3 Locate the **Boundary Selection** section. From the **Selection** list, choose **Outlet**.

Electric Potential - Injection Stage

- 1 In the **Physics** toolbar, click  **Boundaries** and choose **Electric Potential**.
- 2 In the **Settings** window for **Electric Potential**, type Electric Potential - Injection Stage in the **Label** text field.
- 3 Locate the **Boundary Selection** section. From the **Selection** list, choose **Upper Buffer Inlet**.
- 4 Locate the **Electric Potential** section. In the V_0 text field, type V_{appUB} .

Ground - Injection Stage

- 1 In the **Physics** toolbar, click  **Boundaries** and choose **Ground**.
- 2 In the **Settings** window for **Ground**, type Ground - Injection Stage in the **Label** text field.
- 3 Locate the **Boundary Selection** section. From the **Selection** list, choose **Lower Buffer Inlet**.

The use of higher order elements, set in the **Discretization** section of **Transport of Diluted Species**, improves the accuracy of the results significantly for low Reynolds number flows such as those in this model.

TRANSPORT OF DILUTED SPECIES (TDS)

- 1 In the **Model Builder** window, under **Component 1 (comp1)** click **Transport of Diluted Species (tds)**.

- 2 In the **Settings** window for **Transport of Diluted Species**, locate the **Transport Mechanisms** section.
- 3 Select the **Migration in electric field** checkbox.
- 4 Click to expand the **Discretization** section. From the **Concentration** list, choose **Quadratic**.

Species Charges

- 1 In the **Model Builder** window, under **Component 1 (comp1) > Transport of Diluted Species (tds)** click **Species Charges**.
- 2 In the **Settings** window for **Species Properties**, locate the **Charge** section.
- 3 In the z_c text field, type z_c .

Transport Properties - Focusing Stage

- 1 In the **Model Builder** window, under **Component 1 (comp1) > Transport of Diluted Species (tds)** click **Fluid 1**.
- 2 In the **Settings** window for **Fluid**, type **Transport Properties - Focusing Stage** in the **Label** text field.
- 3 Locate the **Model Input** section. From the T list, choose **User defined**. In the associated text field, type T .
- 4 Locate the **Convection** section. From the \mathbf{u} list, choose **Velocity field (spf)**.
- 5 Locate the **Migration in Electric Field** section. From the V list, choose **Electric potential (ec)**.
- 6 Locate the **Diffusion** section. In the D_c text field, type D .

Transport Properties - Injection Stage

- 1 Right-click **Transport Properties - Focusing Stage** and choose **Duplicate**.
- 2 In the **Settings** window for **Fluid**, type **Transport Properties - Injection Stage** in the **Label** text field.
- 3 Locate the **Convection** section. From the \mathbf{u} list, choose **User defined**.

Concentration at Sample Inlet

- 1 In the **Physics** toolbar, click  **Boundaries** and choose **Concentration**.
- 2 In the **Settings** window for **Concentration**, type **Concentration at Sample Inlet** in the **Label** text field.
- 3 Locate the **Boundary Selection** section. From the **Selection** list, choose **Sample Inlet**.
- 4 Locate the **Concentration** section. Select the **Species c** checkbox.
- 5 In the $c_{0,c}$ text field, type c_{in} .

Concentration at Buffer Inlets

- 1 In the **Physics** toolbar, click  **Boundaries** and choose **Concentration**.
- 2 In the **Settings** window for **Concentration**, type Concentration at Buffer Inlets in the **Label** text field.
- 3 Locate the **Boundary Selection** section. From the **Selection** list, choose **Buffer Inlets**.
- 4 Locate the **Concentration** section. Select the **Species c** checkbox.

Outflow I

- 1 In the **Physics** toolbar, click  **Boundaries** and choose **Outflow**.
- 2 In the **Settings** window for **Outflow**, locate the **Boundary Selection** section.
- 3 From the **Selection** list, choose **Outlet**.

Migration at Inlets and Outlets - Injection Stage

- 1 In the **Physics** toolbar, click  **Boundaries** and choose **Flux**.
- 2 In the **Settings** window for **Flux**, type Migration at Inlets and Outlets - Injection Stage in the **Label** text field.
- 3 Locate the **Boundary Selection** section. From the **Selection** list, choose **Migration at Inlets and Outlets - Injection Stage**.
- 4 Locate the **Inward Flux** section. Select the **Species c** checkbox.
- 5 In the $J_{0,c}$ text field, type `-tds.nmflux_c`.

The predefined boundary variable `tds.nmflux_c` gives the outward normal electrophoretic flux, $N_{i \cdot n}$.

CREEPING FLOW (SPF)

Inlet, Sample

- 1 In the **Physics** toolbar, click  **Boundaries** and choose **Inlet**.
- 2 In the **Settings** window for **Inlet**, type Inlet, Sample in the **Label** text field.
- 3 Locate the **Boundary Selection** section. From the **Selection** list, choose **Sample Inlet**.
- 4 Locate the **Boundary Condition** section. From the list, choose **Fully developed flow**.
- 5 Locate the **Fully Developed Flow** section. In the U_{av} text field, type `u_a`.

Inlet, Upper Buffer

- 1 In the **Physics** toolbar, click  **Boundaries** and choose **Inlet**.
- 2 In the **Settings** window for **Inlet**, type Inlet, Upper Buffer in the **Label** text field.
- 3 Locate the **Boundary Selection** section. From the **Selection** list, choose **Upper Buffer Inlet**.

- 4 Locate the **Boundary Condition** section. From the list, choose **Fully developed flow**.
- 5 Locate the **Fully Developed Flow** section. In the U_{av} text field, type w_a .

Inlet, Lower Buffer

- 1 In the **Physics** toolbar, click  **Boundaries** and choose **Inlet**.
- 2 In the **Settings** window for **Inlet**, type Inlet, Lower Buffer in the **Label** text field.
- 3 Locate the **Boundary Selection** section. From the **Selection** list, choose **Lower Buffer Inlet**.
- 4 Locate the **Boundary Condition** section. From the list, choose **Fully developed flow**.
- 5 Locate the **Fully Developed Flow** section. In the U_{av} text field, type w_a .

Outlet 1

- 1 In the **Physics** toolbar, click  **Boundaries** and choose **Outlet**.
- 2 In the **Settings** window for **Outlet**, locate the **Boundary Selection** section.
- 3 From the **Selection** list, choose **Outlet**.
- 4 Locate the **Pressure Conditions** section. Select the **Normal flow** checkbox.

With the settings in the **Discretization** section, a user-controlled mesh with less elements than the physics-controlled mesh can be used.

MESH 1

Free Tetrahedral 1

In the **Mesh** toolbar, click  **Free Tetrahedral**.

Size

- 1 In the **Model Builder** window, click **Size**.
- 2 In the **Settings** window for **Size**, locate the **Element Size** section.
- 3 Click the **Custom** button.
- 4 Locate the **Element Size Parameters** section. In the **Maximum element size** text field, type 29.
- 5 In the **Minimum element size** text field, type 5.
- 6 Click  **Build All**.

Solve the mode A injection in five steps. Choose the features solved for by modifying the physics tree and variables in each study step as shown in the following steps:

STUDY - FOR MODE A

- 1 In the **Model Builder** window, click **Study 1**.

- 2 In the **Settings** window for **Study**, type Study - for Mode A in the **Label** text field.

Stationary - Focusing Stage

- 1 In the **Model Builder** window, under **Study - for Mode A** click **Step 1: Stationary**.
- 2 In the **Settings** window for **Stationary**, type Stationary - Focusing Stage in the **Label** text field.
- 3 Locate the **Physics and Variables Selection** section. In the **Solve for** column of the table, under **Component 1 (comp1)**, clear the checkboxes for **Electric Currents (ec)** and **Transport of Diluted Species (tds)**.

Stationary 2 - Focusing Stage

- 1 In the **Study** toolbar, click  **Stationary**.
- 2 In the **Settings** window for **Stationary**, type Stationary 2 - Focusing Stage in the **Label** text field.
- 3 Locate the **Physics and Variables Selection** section. Select the **Modify model configuration for study step** checkbox.
- 4 In the tree, select **Component 1 (comp1) > Transport of Diluted Species (tds)**.
- 5 Right-click and choose **Disable in Solvers**.
- 6 In the tree, select **Component 1 (comp1) > Creeping Flow (spf)**.
- 7 Right-click and choose **Disable in Solvers**.
- 8 In the tree, select **Component 1 (comp1) > Electric Currents (ec) > Electric Potential - Injection Stage**.
- 9 Right-click and choose **Disable**.
- 10 In the tree, select **Component 1 (comp1) > Electric Currents (ec) > Ground - Injection Stage**.
- 11 Right-click and choose **Disable**.

Stationary 3 - Focusing Stage



- 1 In the **Study** toolbar, click  **Stationary**.
- 2 In the **Settings** window for **Stationary**, type Stationary 3 - Focusing Stage in the **Label** text field.
- 3 Locate the **Physics and Variables Selection** section. Select the **Modify model configuration for study step** checkbox.
- 4 In the tree, select **Component 1 (comp1) > Electric Currents (ec)**.
- 5 Right-click and choose **Disable in Solvers**.
- 6 In the tree, select **Component 1 (comp1) > Creeping Flow (spf)**.

- 7 Right-click and choose **Disable in Solvers**.
- 8 In the tree, select **Component 1 (comp1) > Transport of Diluted Species (tds) > Transport Properties - Injection Stage**.
- 9 Right-click and choose **Disable**.
- 10 In the tree, select **Component 1 (comp1) > Transport of Diluted Species (tds) > Migration at Inlets and Outlets - Injection Stage**.
- 11 Right-click and choose **Disable**.

Stationary - Injection Stage

- 1 In the **Study** toolbar, click  **Stationary**.
- 2 In the **Settings** window for **Stationary**, type Stationary - Injection Stage in the **Label** text field.
- 3 Locate the **Physics and Variables Selection** section. Select the **Modify model configuration for study step** checkbox.
- 4 In the tree, select **Component 1 (comp1) > Electric Currents (ec) > Electric Potential - Focusing Stage and Injection Stage Mode B**.
- 5 Right-click and choose **Disable**.
- 6 In the tree, select **Component 1 (comp1) > Electric Currents (ec) > Ground - Focusing Stage and Injection Stage Mode B**.
- 7 Right-click and choose **Disable**.
- 8 In the tree, select **Component 1 (comp1) > Transport of Diluted Species (tds)**.
- 9 Right-click and choose **Disable in Solvers**.
- 10 In the tree, select **Component 1 (comp1) > Creeping Flow (spf)**.
- 11 Right-click and choose **Disable in Solvers**.



Time Dependent - Injection Stage

- 1 In the **Study** toolbar, click  **Time Dependent**.
- 2 In the **Settings** window for **Time Dependent**, type Time Dependent - Injection Stage in the **Label** text field.
- 3 Locate the **Study Settings** section. In the **Output times** text field, type range(0,0.06,0.6).
- 4 Locate the **Physics and Variables Selection** section. In the **Solve for** column of the table, under **Component 1 (comp1)**, clear the checkboxes for **Electric Currents (ec)** and **Creeping Flow (spf)**.
- 5 In the **Study** toolbar, click  **Compute**.

RESULTS

Plot the concentration at the surface of the channels at selected times. Begin with $t = 0$, which corresponds to the end of the focusing stage and plot [Figure 3](#).

Concentration - Mode A

- 1 In the **Model Builder** window, under **Results** click **Concentration, Surface (tds)**.
- 2 In the **Settings** window for **3D Plot Group**, type **Concentration - Mode A** in the **Label** text field.
- 3 Locate the **Data** section. From the **Time (s)** list, choose **0**.
- 4 In the **Concentration - Mode A** toolbar, click  **Plot**.
- 5 From the **Time (s)** list, choose **0.06**.
- 6 In the **Concentration - Mode A** toolbar, click  **Plot**.

The plot in the **Graphics** window should now look like that in the left panel of [Figure 4](#).

- 7 From the **Time (s)** list, choose **0.12**.
- 8 In the **Concentration - Mode A** toolbar, click  **Plot**.

The plot in the **Graphics** window should now look like that in the left panel of [Figure 5](#).

Cut Line 3D 1

- 1 In the **Results** toolbar, click  **Cut Line 3D**.
- 2 In the **Settings** window for **Cut Line 3D**, locate the **Line Data** section.
- 3 In row **Point 1**, set **x** to 10, **y** to 10, and **z** to 20.
- 4 In row **Point 2**, set **x** to 10, **y** to 10, and **z** to -200.

Plot the cut line to verify that you have entered the correct points; it should run along the center of the lower injection channel and extend past the crossing.

Click  **Plot**.

The plotted cut line should look like this:

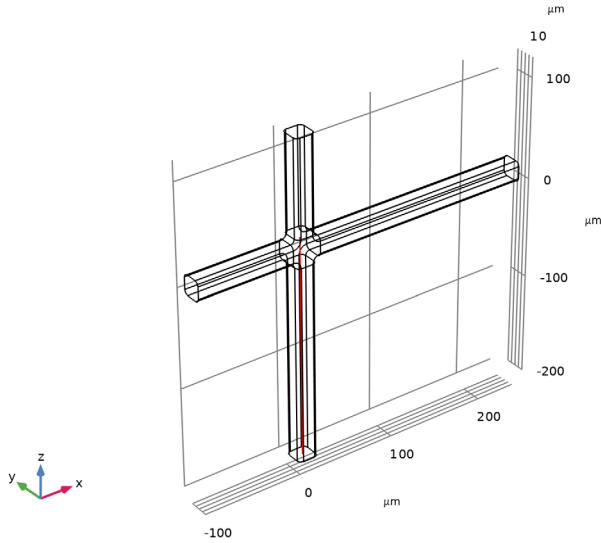

Concentration Line Plot - Mode A

- 1 In the **Results** toolbar, click  **ID Plot Group**.
- 2 In the **Settings** window for **ID Plot Group**, type **Concentration Line Plot - Mode A** in the **Label** text field.
- 3 Locate the **Data** section. From the **Dataset** list, choose **Cut Line 3D I**.
- 4 Locate the **Legend** section. From the **Layout** list, choose **Outside graph axis area**.



Line Graph 1

- 1 Right-click **Concentration Line Plot - Mode A** and choose **Line Graph**.
- 2 In the **Settings** window for **Line Graph**, click **Replace Expression** in the upper-right corner of the **y-Axis Data** section. From the menu, choose **Component 1 (comp1) > Transport of Diluted Species > Species c > c - Molar concentration, c - mol/m³**.
- 3 Locate the **x-Axis Data** section. From the **Parameter** list, choose **Expression**.
- 4 In the **Expression** text field, type $10[\text{um}] - z$.
- 5 Click to expand the **Coloring and Style** section. From the **Color cycle** list, choose **Long**.
- 6 Click to expand the **Legends** section. Select the **Show legends** checkbox.
- 7 In the **Concentration Line Plot - Mode A** toolbar, click  **Plot**.

Compare the results with the upper plot in [Figure 6](#).

Now change the boundary conditions to correspond to injection mode B, then set up a solver and compute the solution before generating plots to compare with those for injection mode A.

ADD STUDY

- 1 In the **Home** toolbar, click  **Add Study** to open the **Add Study** window.
- 2 Go to the **Add Study** window.
- 3 Find the **Studies** subsection. In the **Select Study** tree, select **General Studies > Stationary**.
- 4 Click the **Add Study** button in the window toolbar.
- 5 In the **Home** toolbar, click  **Add Study** to close the **Add Study** window.

Solve the mode B injection in five steps. Choose the features solved for by modifying the physics tree and variables in each study step as shown in the following steps:

STUDY - FOR MODE B

In the **Settings** window for **Study**, type Study - for Mode B in the **Label** text field.

Stationary - Focusing Stage

- 1 In the **Model Builder** window, under **Study - for Mode B** click **Step 1: Stationary**.
- 2 In the **Settings** window for **Stationary**, locate the **Physics and Variables Selection** section.
- 3 In the **Solve for** column of the table, under **Component 1 (comp1)**, clear the checkboxes for **Electric Currents (ec)** and **Transport of Diluted Species (tds)**.
- 4 In the **Label** text field, type Stationary - Focusing Stage.

Stationary 2 - Focusing Stage

- 1 In the **Study** toolbar, click  **Stationary**.
- 2 In the **Settings** window for **Stationary**, type Stationary 2 - Focusing Stage in the **Label** text field.
- 3 Locate the **Physics and Variables Selection** section. Select the **Modify model configuration for study step** checkbox.
- 4 In the tree, select **Component 1 (comp1) > Electric Currents (ec) > Electric Potential - Injection Stage**.
- 5 Right-click and choose **Disable**.
- 6 In the tree, select **Component 1 (comp1) > Electric Currents (ec) > Ground - Injection Stage**.
- 7 Right-click and choose **Disable**.
- 8 In the tree, select **Component 1 (comp1) > Transport of Diluted Species (tds)**.

- 9 Right-click and choose **Disable in Solvers**.
- 10 In the tree, select **Component 1 (comp1) > Creeping Flow (spf)**.
- 11 Right-click and choose **Disable in Solvers**.

Stationary 3 - Focusing Stage

- 1 In the **Study** toolbar, click  **Stationary**.
- 2 In the **Settings** window for **Stationary**, type Stationary 3 - Focusing Stage in the **Label** text field.
- 3 Locate the **Physics and Variables Selection** section. Select the **Modify model configuration for study step** checkbox.
- 4 In the tree, select **Component 1 (comp1) > Electric Currents (ec)**.
- 5 Right-click and choose **Disable in Solvers**.
- 6 In the tree, select **Component 1 (comp1) > Transport of Diluted Species (tds) > Transport Properties - Injection Stage**.
- 7 Right-click and choose **Disable**.
- 8 In the tree, select **Component 1 (comp1) > Transport of Diluted Species (tds) > Migration at Inlets and Outlets - Injection Stage**.
- 9 Right-click and choose **Disable**.
- 10 In the tree, select **Component 1 (comp1) > Creeping Flow (spf)**.
- 11 Right-click and choose **Disable in Solvers**.

Stationary - Injection Stage

- 1 In the **Study** toolbar, click  **Stationary**.
- 2 In the **Settings** window for **Stationary**, type Stationary - Injection Stage in the **Label** text field.
- 3 Locate the **Physics and Variables Selection** section. In the **Solve for** column of the table, under **Component 1 (comp1)**, clear the checkboxes for **Transport of Diluted Species (tds)** and **Creeping Flow (spf)**.

Time Dependent - Injection Stage



- 1 In the **Study** toolbar, click  **Time Dependent**.
- 2 In the **Settings** window for **Time Dependent**, type Time Dependent - Injection Stage in the **Label** text field.
- 3 Locate the **Study Settings** section. In the **Output times** text field, type range(0,0.06, 0.6).

- 4 Locate the **Physics and Variables Selection** section. In the **Solve for** column of the table, under **Component 1 (comp1)**, clear the checkboxes for **Electric Currents (ec)** and **Creeping Flow (spf)**.
- 5 In the **Study** toolbar, click  **Compute**.

RESULTS

Plot the concentration at the surface of the channels at selected times for mode B.

Concentration - Mode B

- 1 In the **Model Builder** window, under **Results** click **Concentration, Surface (tds)**.
- 2 In the **Settings** window for **3D Plot Group**, type Concentration - Mode B in the **Label** text field.
- 3 Locate the **Data** section. From the **Time (s)** list, choose **0.06**.
- 4 In the **Concentration - Mode B** toolbar, click  **Plot**.
Compare the results with those on the right side of [Figure 4](#).
- 5 In the **Model Builder** window, click **Concentration - Mode B**.
- 6 From the **Time (s)** list, choose **0.12**.
- 7 In the **Concentration - Mode B** toolbar, click  **Plot**.

Compare the results with those on the right side of [Figure 5](#).

Add a second **Cut Line 3D** node for Injection stage mode B.

Cut Line 3D 2

- 1 In the **Results** toolbar, click  **Cut Line 3D**.
- 2 In the **Settings** window for **Cut Line 3D**, locate the **Data** section.
- 3 From the **Dataset** list, choose **Study - for Mode B/Solution 6 (sol6)**.
- 4 Locate the **Line Data** section. In row **Point 1**, set **x** to 10, **y** to 10 [um], and **z** to 20 [um].
- 5 In row **Point 2**, set **x** to 10, **y** to 10 [um], and **z** to -200 [um].

Concentration Line Plot - Mode B

- 1 In the **Results** toolbar, click  **ID Plot Group**.
- 2 In the **Settings** window for **ID Plot Group**, type Concentration Line Plot - Mode B in the **Label** text field.
- 3 Locate the **Data** section. From the **Dataset** list, choose **Cut Line 3D 2**.
- 4 Locate the **Legend** section. From the **Layout** list, choose **Outside graph axis area**.

Line Graph 1

- 1** Right-click **Concentration Line Plot - Mode B** and choose **Line Graph**.
- 2** In the **Settings** window for **Line Graph**, click **Replace Expression** in the upper-right corner of the **y-Axis Data** section. From the menu, choose **Component 1 (comp1) > Transport of Diluted Species > Species c > c - Molar concentration, c - mol/m³**.
- 3** Locate the **x-Axis Data** section. From the **Parameter** list, choose **Expression**.
- 4** In the **Expression** text field, type $10[\text{um}] - z$.
- 5** Click to expand the **Coloring and Style** section. From the **Color cycle** list, choose **Long**.
- 6** Click to expand the **Legends** section. Select the **Show legends** checkbox.
- 7** In the **Concentration Line Plot - Mode B** toolbar, click  **Plot**.

Compare the results with the lower plot in [Figure 6](#).

Several plot groups are not used and can be removed. To do so, press and hold the Ctrl key and select the plots for **Electric Potential (ec)**, **Concentration**, **Streamline (tds)**, **Velocity (spf)**, and **Pressure (spf)**. Then right-click and choose **Delete**.