



Model created in COMSOL Multiphysics 6.4

A 3D Model of a Diesel Particulate Filter

Introduction

This example studies the averaged flow field, concentration, and temperature distribution in a homogenized model of a diesel particulate filter (DPF). The filter consists of a series of parallel channels that are closed off in an alternating fashion. The walls shared by neighboring channels are porous, allowing gas to pass through them while at the same time separating particles from the flow (Figure 1).

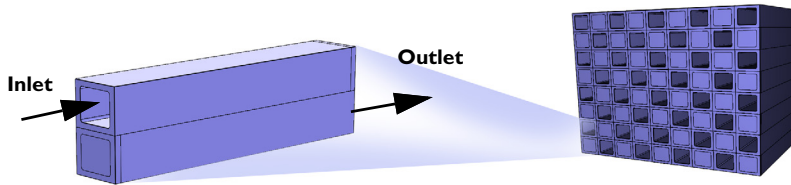

Figure 1: Drawing of a diesel particulate filter. At the reactor's inlet the outlet channel is closed, while at the reactor's outlet the inlet channel is closed.

Several factors influence a DPF's efficiency and durability. Important issues include the removal of soot particles from the filter membranes and the influence of thermal stress on the ceramic structure, stress that arises during repeated operating cycles. Mathematical modeling provides a powerful tool for investigating such critical parameters under a wide range of operating conditions.

This example sets up and solves the coupled flow plus mass and thermal transport equations describing the transport/reaction phenomena in a diesel particulate filter. An important aspect it illustrates is how you can tailor the predefined application modes of COMSOL Multiphysics to represent a specialized mathematical model.

Model Definition

In a detailed DPF model, you can treat the channels and porous membrane with their true geometry with the only simplification being the membrane description. The membrane could, for example, be described with a porous-media approach using effective transport properties. Flow in the channels is expected to be close to fully developed laminar flow although there could be a slight deviation due to the relatively small flow of fluid over the membrane from the inlet to the outlet channels.

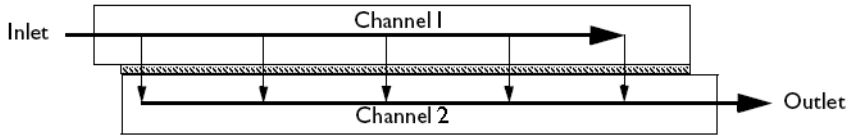

Figure 2: Cross section of a unit cell consisting of an inlet and an outlet channel separated by a porous membrane.

In general, a detailed model of the flow in the hundreds or even thousands of channels that make up a full filter geometry is not feasible due to the demands on computer capability. However, a homogenized model is realizable. Using such an approach, assume that the velocity profile is that of a fully developed laminar flow. The average flow rate in a cross section of one channel is proportional to the pressure gradient in the channel:

$$\mathbf{u} = -k_1 \nabla p \quad (1)$$

Here \mathbf{u} denotes the flow velocity (m/s), k_1 represents a lumped friction factor ($\text{m}^2/(\text{Pa}\cdot\text{s})$), and p is the pressure (Pa).

VELOCITY AND PRESSURE

You can obtain the average velocity in the inlet channel from a mass balance. The velocity in this channel decreases as gas passes through the porous membrane to the outlet channel. The crossover of gas from an inlet to an outlet channel is assumed to be proportional to the pressure difference across the membrane.

Figure 3 shows the geometric unit cell used to set up the balance equations.

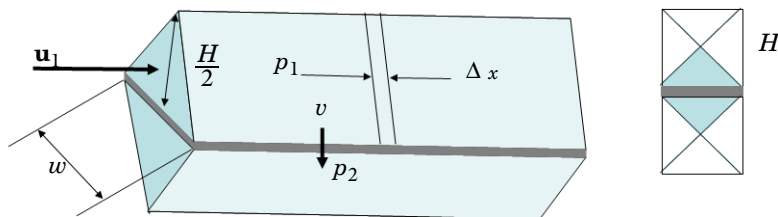

Figure 3: Geometric unit cell for the homogenized DPF model. Each inlet channel has porous walls in common with four outlet channels and vice versa.

For an inlet channel, the balance equation with respect to mass flow becomes

$$\frac{\partial \rho_1}{\partial t} + \frac{\partial}{\partial x} \left(-\rho_1 k_1 \frac{\partial p_1}{\partial x} \right) = -\frac{\rho_1 4 \kappa_m}{H \eta \delta_m} (p_1 - p_2) \quad (2)$$

where κ_m denotes the porous membrane's permeability (m^2), H is the channel height (m), η denotes the fluid's viscosity (Pa.s), δ_m gives the membrane's thickness (m), p_1 represents the pressure in the inlet channel (Pa), and p_2 equals the pressure in the outlet channel (Pa).

The density is a function of pressure according to the ideal gas law:

$$\rho_1 = \frac{p_1 M_1}{R_g T_1} \quad (3)$$

Here M_1 denotes the fluid's average molecular weight (kg/mol), R_g is the gas constant (J/(mol.K)), and T_1 gives the temperature in the inlet channel (K).

The corresponding equation for the outlet channel is

$$\frac{\partial \rho_2}{\partial t} + \frac{\partial}{\partial x} \left(-\rho_2 k_1 \frac{\partial p_2}{\partial x} \right) = \frac{\rho_2 4 \kappa_m}{H \eta \delta_m} (p_1 - p_2) \quad (4)$$

Note that the source/sink terms in [Equation 2](#) and [Equation 4](#) are proportional to the volumetric flow through the membrane per unit area, or the superficial velocity:

$$v_m = \frac{\kappa_m p_1 - p_2}{\eta \delta_m} \quad (5)$$

The pressure fields and thus also this velocity field vary only in the x direction, and each inlet channel is separated from the other inlet channels by an impermeable wall. The inlet and outlet pressures connect the array of inlet channels to each other. If the porous membrane's permeability, encoded in the variable κ_m , varies in the filter, a corresponding distribution of the superficial velocity in the inlet and outlet channels results. In addition, the temperature field is connected for the entire system, and heat flows between the different unit cells. For this reason it is appropriate to expand the 1D model to a 3D model that accounts for the impermeability of the walls separating the inlet and outlet channels in adjacent unit cells.

You can express this impermeability with a diagonal friction tensor, k , where only the xx component is nonzero and equal to k_1 . The model equations then read

$$\frac{\partial \rho_1}{\partial t} + \nabla \cdot (-\rho_1 k \nabla p_1) = -\rho_1 \frac{4 \kappa_m}{H \eta \delta_m} (p_1 - p_2) \quad (6)$$

and

$$\frac{\partial \rho_2}{\partial t} + \nabla \cdot (-\rho_2 k \nabla p_2) = \rho_2 \frac{4\kappa_m}{H\eta\delta_m} (p_1 - p_2) \quad (7)$$

These equations are valid if the permeability and thickness of the porous membrane are constant throughout the process, which is not the case when soot particles deposit on the membrane surface. However, you can derive a model analogous to the one just described by assuming that two porous membranes separate the outlet and inlet channels, one formed by the soot layer and the second one being the porous membrane just described. This approach results in the following equations:

$$\frac{\partial \rho_1}{\partial t} + \nabla \cdot (-\rho_1 k \nabla p_1) = -\frac{ab}{a+b} \rho_1 (p_1 - p_2) \quad (8)$$

and

$$\frac{\partial \rho_2}{\partial t} + \nabla \cdot (-\rho_2 k \nabla p_2) = \frac{ab}{a+b} \rho_2 (p_1 - p_2) \quad (9)$$

Here a and b are defined by the equations

$$a = \frac{4\kappa_m}{H\eta\delta_m} \quad (10)$$

$$b = \frac{4\kappa_s}{H\eta\delta_s} \quad (11)$$

where κ_s denotes the soot layer's permeability (m^2), and δ_s equals its thickness (m). The superficial flow velocity through the membrane is now given by

$$v_m = \frac{ab}{a+b} (p_1 - p_2) = \frac{4\kappa_s \kappa_m}{H\eta(\kappa_m \delta_s + \kappa_s \delta_m)} (p_1 - p_2) \quad (12)$$

At the filter entrance, the boundary condition for the inlet channels specifies a given pressure. All other boundaries are insulating, that is,

$$(-\rho_1 k \nabla p_1) \cdot \mathbf{n} = 0 \quad (13)$$

where \mathbf{n} denotes the normal vector to the boundary.

The boundary conditions for the outlet channels specify the pressure at the filter exit and impose insulation at all other boundaries:

$$(-\rho_2 k \nabla p_2) \cdot \mathbf{n} = 0 \quad (14)$$

MASS BALANCES

The soot particles are present only in the inlet channel because they are deposited as a film on the porous membrane. A balance for soot particles introduces the deposition of soot particles as a sink to the flux of particles in the open channel. This gives the transport equation

$$\frac{\partial c_s}{\partial t} + \nabla \cdot (-D_s \nabla c_s + c_s \mathbf{u}_1) + \frac{4}{H} c_s v = 0 \quad (15)$$

where c_s denotes the soot-particle concentration (mol/m^3), and D_s is the diffusivity of soot particles (m^2/s).

The model defines the concentration of oxygen using two mass balances, one for the inlet and another for the outlet channel. The mass balance in the inlet channel contains the term where oxygen reacts in the combustion reaction with soot. The mass balance in the inlet channel is represented by the equation

$$\frac{\partial c_{o2,1}}{\partial t} + \nabla \cdot (-D_{o2} \nabla c_{o2,1} + c_{o2,1} \mathbf{u}_1) + \frac{4}{H} c_{o2,1} v_m + \frac{4}{H} R_s = 0 \quad (16)$$

where c_{o2} denotes the oxygen concentration (mol/m^3), D_{o2} gives the diffusion coefficient (m^2/s), and R_s equals the reaction rate for the surface reaction ($\text{mol}/(\text{m}^2 \cdot \text{s})$).

The corresponding balance for oxygen in the outlet channel yields

$$\frac{\partial c_{o2,2}}{\partial t} + \nabla \cdot (-D_{o2} \nabla c_{o2,2} + c_{o2,2} \mathbf{u}_2) - \frac{4}{H} c_{o2,1} v_m = 0 \quad (17)$$

Note the addition of the flow term of oxygen over the membrane as a source term in the outlet channel balance.

The balance of soot results in an expression for the growth or consumption of the soot layer:

$$\frac{\partial \delta_s}{\partial t} + \frac{M_s}{\rho_s} (R_s - c_s v) = 0 \quad (18)$$

where δ_s denotes the soot layer's thickness (m), ρ_s represents its effective density (kg/m^3), and M_s equals the molecular weight of carbon (kg/mol).

The boundary condition for $c_{o2,1}$ sets the concentration at the inlet, while insulation is used for all other boundaries. For $c_{o2,2}$, use a convective flux condition at the outlet and set all other boundaries to insulation. The initial conditions for both $c_{o2,1}$ and $c_{o2,2}$ are 0.

ENERGY BALANCE

The energy balance in the reactor consists of three equations: one for the inlet channels, one for the porous membranes, and one for the outlet channels.

The balance for the inlet channels reads

$$\rho_1 C_{p1} \frac{\partial T_1}{\partial t} + \nabla \cdot \mathbf{q}_1 + \frac{4}{H} \rho_1 C_{p1} T_1 v_m - \frac{4}{H} h (T_m - T_1) = 0 \quad (19)$$

$$\mathbf{q}_1 = -k_1 \nabla T_1 + \rho_1 C_{p1} T_1 \mathbf{u}_1 \quad (20)$$

where T_1 is the temperature in the inlet channels (K), T_m is the temperature in the membrane (K), C_{p1} gives the heat capacity of the gas in the inlet channel (J/(kg·K)), h equals the heat transfer coefficient (W/(m²·K)), and \mathbf{q}_1 is the flux vector.

In the membrane, the energy equation is given by

$$\rho_m C_{pm} \frac{\partial T_m}{\partial t} + \nabla \cdot \mathbf{q}_m + \frac{v_m}{\delta_m} (\rho_2 C_{p2} T_m - \rho_1 C_{p1} T_1) + \frac{h}{\delta_m} (2T_m - T_1 - T_2) = 0 \quad (21)$$

$$\mathbf{q}_m = -k_m \nabla T_m \quad (22)$$

Here the subscript “m” refers to the membrane so that T_m is its temperature, T_2 equals the temperature in the outlet channels (K), C_{p2} refers to the heat capacity of the gas in the outlet channels (J/(kg·K)), and h is the heat transfer coefficient between the membrane and the channels.

The last equation determines the temperature in the outlet channel:

$$\rho_2 C_{p2} \frac{\partial T_2}{\partial t} + \nabla \cdot \mathbf{q}_2 - \frac{4}{H} \rho_2 C_{p2} T_2 v_m - \frac{4}{H} h (T_m - T_2) = 0 \quad (23)$$

$$\mathbf{q}_2 = -k_2 \nabla T_2 + \rho_2 C_{p2} T_2 \mathbf{u}_2 \quad (24)$$

The boundary conditions for the inlet channel are a given temperature at the inlet and insulation at all other boundaries. At the outlet channel, use a convective flux condition at

the outlet and set all other boundaries to insulation. The initial condition specifies a temperature equal to the inlet temperature of the gas.

For the membrane, the heat flux through the boundaries is given by

$$\mathbf{q}_m \cdot \mathbf{n} = h_{\text{outer}}(T_m - T_{\text{amb}}) \quad (25)$$

where h_{outer} denotes the heat transfer coefficient, and T_{amb} equals the ambient temperature. The initial temperature is set equal to the inlet temperature.

HOMOGENIZED FILTER GEOMETRY

The balance equations covered above are implemented on a 3D filter geometry. The cross section of the filter is an oval, 5.86 inches in width, 4.66 inches in height, and the length of the filter is 8 inches. Mirror symmetry reduces the geometry to one quarter of the filter.

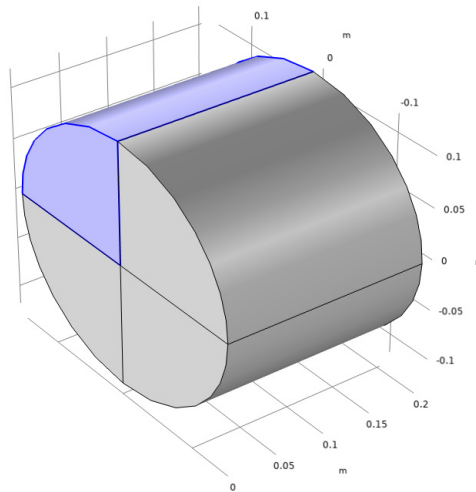

Figure 4: Symmetry reduces the modeling geometry to one quarter of the full filter.

MESH

Boundary layer meshing is used to create a denser mesh in the radial direction of the filter, near the outer surface. When extruding the cross sectional mesh you can further control the distribution to get a denser mesh near the filter inlet and outlet.

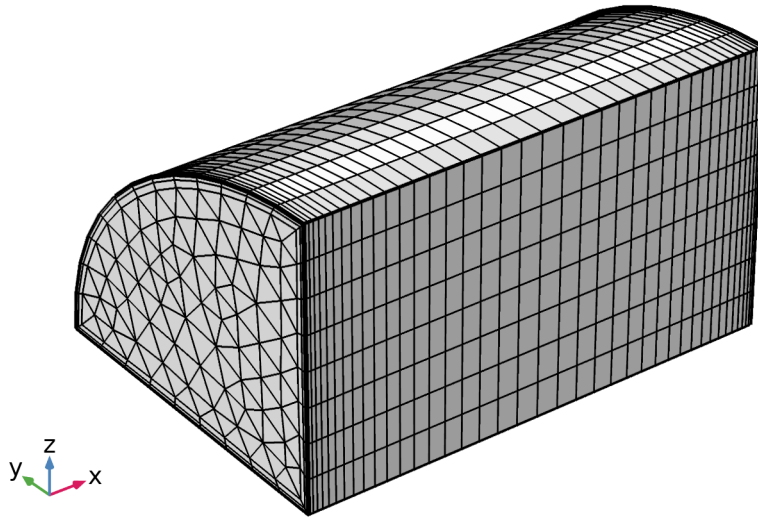

Figure 5: Boundary layer meshing and mesh extrusion make it possible to efficiently discretize the geometry.

Results and Discussion

Figure 6 shows the gas velocity along the inlet and outlet filter channels. At the start of the simulation ($t = 0$), a $25\text{-}\mu\text{m}$ layer of soot is evenly distributed on top of the porous membranes of the inlet channels. The pressure difference over the filter is 50 Pa.

The top panel in Figure 7 shows the pressure difference ($p_1 - p_2$) across an inlet/outlet channel pair located at the center of the filter. The bottom panel illustrates the buildup of soot during 15 minutes of simulated operation with no carbon oxidation present. As expected, soot builds up primarily at the channel's entrance and end, because this is where the pressure gradient and, consequently, the trans-membrane velocity have their highest values.

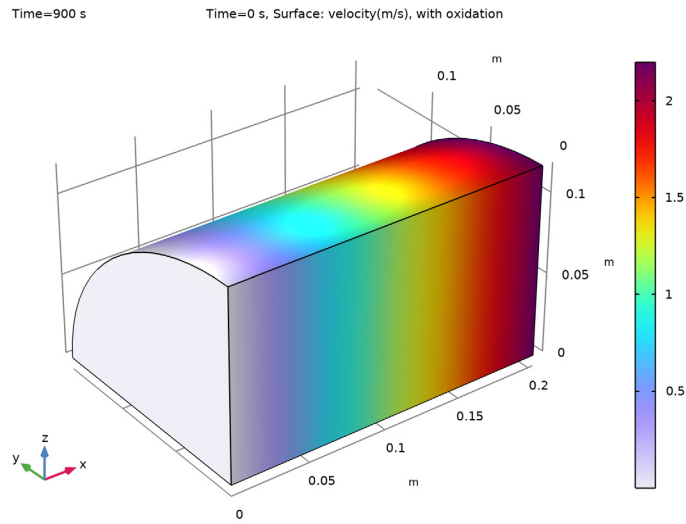
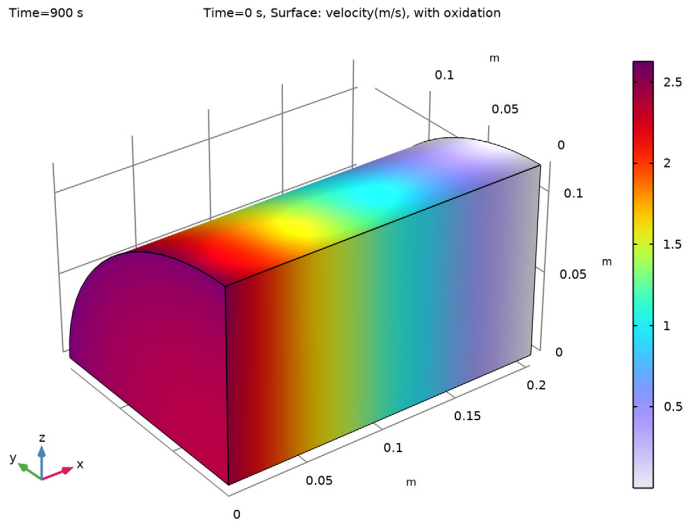

Figure 6: Gas velocity (m/s) in the inlet channels (v_1 , top) and outlet channels (v_2 , bottom).

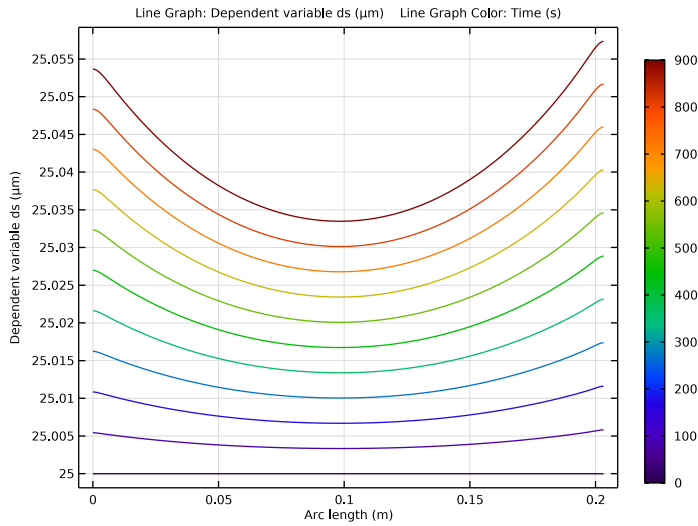
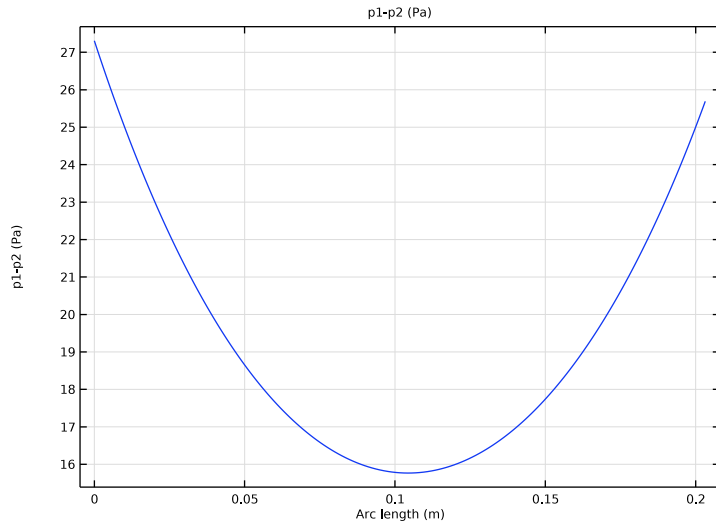

Figure 7: Pressure difference (top) and soot-layer thickness (bottom) along a channel located at the filter centerline. No soot oxidation is present.

The top image of [Figure 8](#) shows the filter temperature distribution, T_m , when the inlet gas temperature is 550 K, and the ambient temperature is set to 300 K. Furthermore, the effect of soot oxidation is disregarded. The temperature gradients due to cooling of the

filter's outer surface are evident. The bottom image shows T_m , when soot oxidation is taken into account. Filter temperatures exceeding that of the inlet gas are observed in the front end of the filter.

Figure 9 illustrates the time evolution of the soot layer's thickness (0–900 s). The layer grows due to the deposition of particles from the gas phase, and it is removed by oxidation. Results are shown for a channel located at the filter periphery (top) and at the center of the filter (bottom).

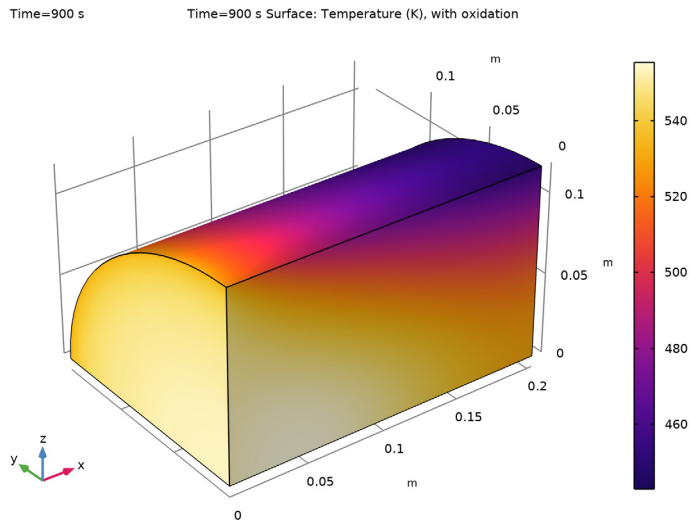
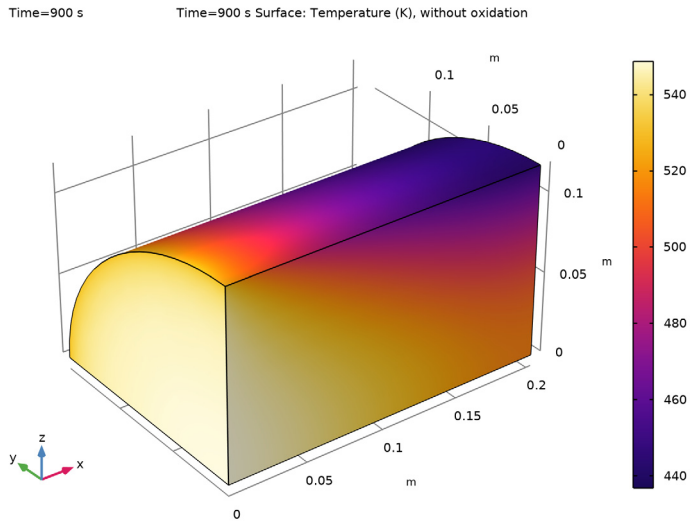

Figure 8: Filter temperature, T_m , when no oxidation takes place (top), and when soot oxidation is taken into account (bottom).

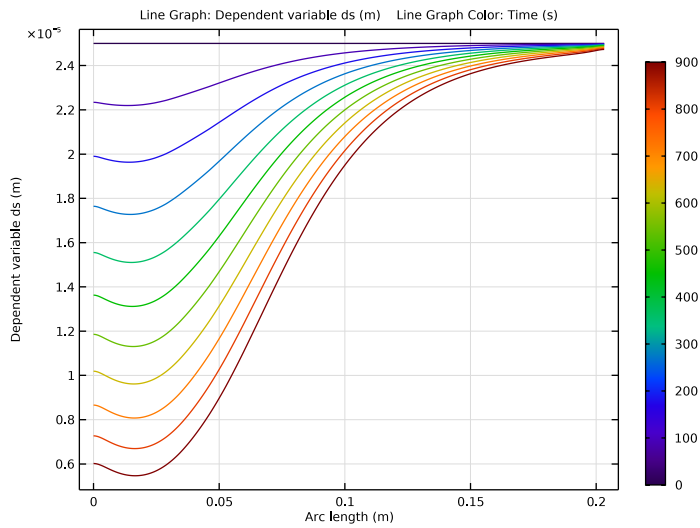
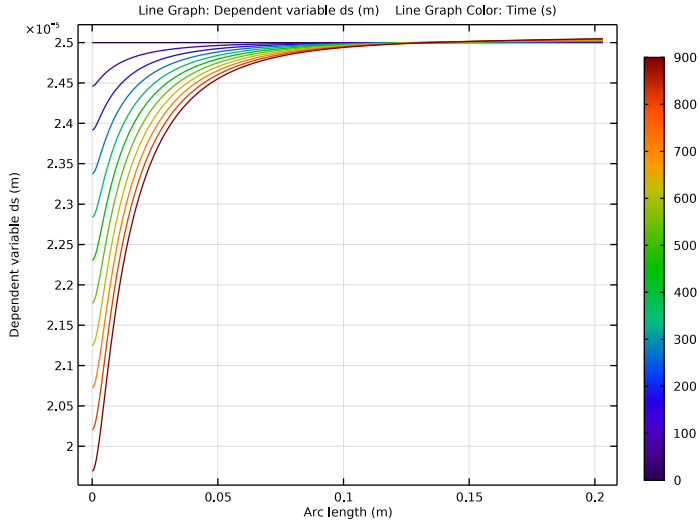

Figure 9: Soot-layer thickness along a channel located at the filter periphery (top) and at the filter centerline (bottom).

Clearly, soot removal is less efficient in the peripheral parts of the filter as lower temperature in these areas decreases the oxidation rate significantly.

Finally, [Figure 10](#) shows the pressure drop across a centrally placed channel pair as function of time (0–900 s). In accordance with the diminishing soot layer illustrated in [Figure 9](#), the pressure drop is reduced in the front end of the filter.

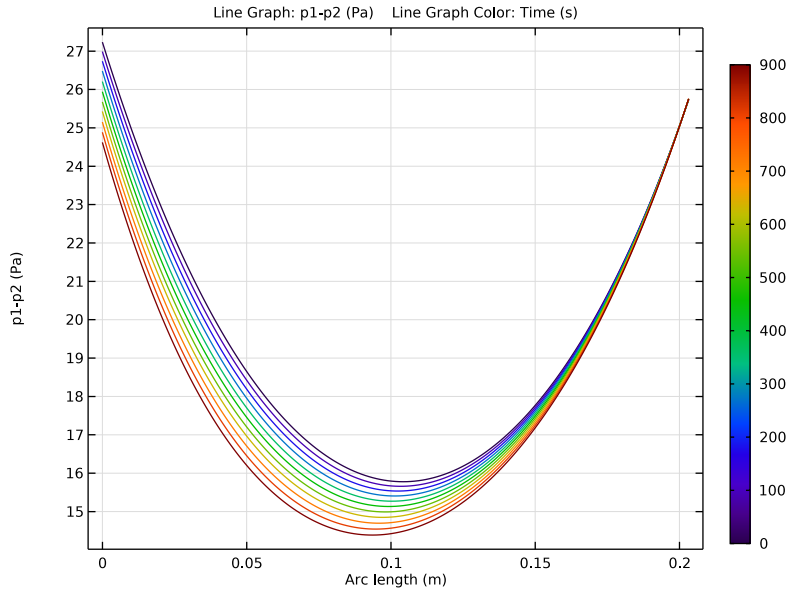



Figure 10: The pressure drop across a centrally placed channel pair is affected by the diminishing soot layer.

Application Library path: Chemical_Reaction_Engineering_Module/
Reactors_with_Porous_Catalysts/diesel_particulate_filter

Modeling Instructions

From the **File** menu, choose **New**.

NEW

In the **New** window, click  **Model Wizard**.

MODEL WIZARD

1 In the **Model Wizard** window, click  **3D**.

Add one **Chemistry**, three **Transport of Diluted Species**, two **Darcy's Law**, three **Heat Transfer in Fluids**, and one **General Form PDE** interfaces.

2 In the **Select Physics** tree, select **Chemical Species Transport > Chemistry (chem)**.

3 Click **Add**.

4 In the **Select Physics** tree, select **Chemical Species Transport > Transport of Diluted Species (tds)**.

5 Click **Add**.

6 In the **Concentrations (mol/m³)** table, enter the following settings:

c1_02

7 Click **Add**.

8 In the **Concentrations (mol/m³)** table, enter the following settings:

c2_C

9 Click **Add**.

10 In the **Concentrations (mol/m³)** table, enter the following settings:

c3_02

11 In the **Select Physics** tree, select **Fluid Flow > Porous Media and Subsurface Flow > Darcy's Law (dl)**.

12 Click **Add**.

13 In the **Pressure (Pa)** text field, type p1.

14 Click **Add**.

15 In the **Pressure (Pa)** text field, type p2.

16 In the **Select Physics** tree, select **Heat Transfer > Heat Transfer in Fluids (ht)**.

17 Click **Add**.

18 In the **Temperature (K)** text field, type T1.

19 Click **Add**.

20 In the **Temperature (K)** text field, type Tm.

21 Click **Add**.

22 In the **Temperature (K)** text field, type T2.

23 In the **Select Physics** tree, select **Mathematics > PDE Interfaces > General Form PDE (g)**.

24 Click **Add**.

25 In the **Field name (I)** text field, type `ds`.

26 In the **Dependent variables (I)** table, enter the following settings:

<code>ds</code>

27 Click  **Select Dependent Variable Quantity**.

28 In the **Physical Quantity** dialog, type `length` in the text field.

29 In the tree, select **General > Length (m)**.

30 Click **OK**.

31 In the **Model Wizard** window, click  **Select Source Term Quantity**.

32 In the **Physical Quantity** dialog, type `velocity` in the text field.

33 In the tree, select **General > Velocity (m/s)**.

34 Click **OK**.

35 In the **Model Wizard** window, click  **Study**.

36 In the **Select Study** tree, select **General Studies > Stationary**.

37 Click  **Done**.

GLOBAL DEFINITIONS

Load the model parameters from a text file.

Parameters 1

1 In the **Model Builder** window, under **Global Definitions** click **Parameters 1**.

2 In the **Settings** window for **Parameters**, locate the **Parameters** section.

3 Click  **Load from File**.

4 Browse to the model's Application Libraries folder and double-click the file `diesel_particulate_filter_parameters.txt`.

DEFINITIONS

Load the variable definitions from a text file.

Variables 1

1 In the **Model Builder** window, under **Component 1 (comp1)** right-click **Definitions** and choose **Variables**.

2 In the **Settings** window for **Variables**, locate the **Variables** section.

- 3 Click  **Load from File**.
- 4 Browse to the model's Application Libraries folder and double-click the file `diesel_particulate_filter_variables.txt`.

GEOMETRY I

Work Plane 1 (wp1)

- 1 In the **Geometry** toolbar, click  **Work Plane**.
- 2 In the **Settings** window for **Work Plane**, locate the **Plane Definition** section.
- 3 From the **Plane** list, choose **yz-plane**.

Work Plane 1 (wp1) > Plane Geometry

- 1 In the **Model Builder** window, click **Plane Geometry**.
- 2 In the **Settings** window for **Plane Geometry**, locate the **Visualization** section.
- 3 Find the **In-plane visualization of 3D geometry** subsection. Clear the **Coincident entities (blue)** checkbox.
- 4 Clear the **Intersection (green)** checkbox.



Work Plane 1 (wp1) > Ellipse 1 (e1)

- 1 In the **Work Plane** toolbar, click  **Ellipse**.
 - 2 In the **Settings** window for **Ellipse**, locate the **Size and Shape** section.
 - 3 In the **a-semiaxis** text field, type 5.86[in].
 - 4 In the **b-semiaxis** text field, type 4.66[in].
 - 5 In the **Sector angle** text field, type 90.
- Symmetry allows you to reduce the cross section to one quarter of the ellipse.

Extrude 1 (ext1)

- 1 In the **Model Builder** window, right-click **Geometry I** and choose **Extrude**.
- 2 In the **Settings** window for **Extrude**, locate the **Distances** section.
- 3 In the table, enter the following settings:

Distances (m)
8[in]

- 4 Click  **Build All Objects**.
- 5 Click the  **Zoom Extents** button in the **Graphics** toolbar.

CHEMISTRY (CHEM)

Because the reaction happens in the soot layer, couple the reaction temperature to the temperature from the **Heat Transfer in Fluids** interface on the soot layer.

- 1 In the **Model Builder** window, under **Component 1 (comp1)** click **Chemistry (chem)**.
- 2 In the **Settings** window for **Chemistry**, locate the **Model Input** section.
- 3 From the T list, choose **Temperature (ht2)**.

Reaction 1

The reaction happens on the surface of the catalyst.

- 1 In the **Physics** toolbar, click  **Domains** and choose **Reaction**.
- 2 In the **Settings** window for **Reaction**, locate the **Reaction Formula** section.
- 3 In the **Formula** text field, type $C+O_2+C_{ex}O_y(ads) \Rightarrow CO_2+C_{ex}O_y(ads)$.
- 4 Click **Apply**.
- 5 Locate the **Reaction Rate** section. From the list, choose **User defined**.
- 6 In the r_j text field, type $Rs_factor*chem.kf_1*chem.c_O_2$.
- 7 Locate the **Reaction Orders** section. Find the **Volumetric overall reaction order** subsection. In the **Forward** text field, type 1.
- 8 Find the **Surface overall reaction order** subsection. In the **Forward** text field, type 0.
The Rs_factor in the above **Reaction rate** expression will be used in the **Parametric Sweep** to study the model with and without oxidation reaction.
- 9 Locate the **Rate Constants** section. Select the **Use Arrhenius expressions** checkbox.
- 10 In the A^f text field, type Af .
- 11 In the E^f text field, type Ef .
Assume that the enthalpy of reaction is constant, independent of temperature.
- 12 Locate the **Reaction Thermodynamic Properties** section. From the **Enthalpy of reaction** list, choose **User defined**.
- 13 In the H text field, type H_ox .

Surface species: CexOy(ads)

The site density on the catalyst surface is held constant.

- 1 In the **Model Builder** window, click **Surface species: CexOy(ads)**.
- 2 In the **Settings** window for **Species**, click to expand the **Constant Concentration/Activity** section.

3 Select the **Keep concentration/activity constant** checkbox.

The oxygen concentration in the reaction is set equal to that in the inlet channel (c1_O2).

4 In the **Model Builder** window, click **Chemistry (chem)**.

5 In the **Settings** window for **Chemistry**, locate the **Species Matching** section.

6 Find the **Bulk species** subsection. From the **Species solved for** list, choose **Transport of Diluted Species**.

7 In the table, enter the following settings:

Species	Type	Molar concentration	Value (mol/m ³)
C	Variable	User defined	c_C_in
CO2	Variable	User defined	1
O2	Variable	c1_O2	Solved for

8 Find the **Surface species** subsection. In the table, enter the following settings:

Species	Type	Surface concentration	Value (mol/m ²)
CexOy(ads)	Constant	User defined	1

9 Click the  **Show More Options** button in the **Model Builder** toolbar.

10 In the **Show More Options** dialog, in the tree, select the checkbox for the node **Physics > Advanced Physics Options**.

11 Click **OK**.

TRANSPORT OF DILUTED SPECIES (TDS)

1 In the **Model Builder** window, under **Component 1 (comp1)** click **Transport of Diluted Species (tds)**.

2 In the **Settings** window for **Transport of Diluted Species**, click to expand the **Advanced Settings** section.

3 From the **Material balance form** list, choose **Conservative**.

Fluid 1

1 In the **Model Builder** window, under **Component 1 (comp1)** > **Transport of Diluted Species (tds)** click **Fluid 1**.

2 In the **Settings** window for **Fluid**, locate the **Convection** section.

3 Specify the \mathbf{u} vector as

v1	x
----	---

4 Locate the **Diffusion** section. From the list, choose **Diagonal**.

5 Specify the D_{c1O2} matrix as

D_O2	0	0
0	0	0
0	0	0

Reactions 1

1 In the **Physics** toolbar, click  **Domains** and choose **Reactions**.

The mass source of oxygen consists of two parts: one from the reaction and the other from the outflow to the soot layer (or membrane).

2 Select Domain 1 only.

3 In the **Settings** window for **Reactions**, locate the **Reaction Rates** section.

4 In the R_{c1O2} text field, type $-(4/H)*v_m*c1_{O2}+(4/H)*chem.Rsurf_{O2}$.

Inflow 1

1 In the **Physics** toolbar, click  **Boundaries** and choose **Inflow**.

2 Select Boundary 1 only.

3 In the **Settings** window for **Inflow**, locate the **Concentration** section.

4 In the $c_{0,c1O2}$ text field, type c_{O2_in} .

TRANSPORT OF DILUTED SPECIES 2 (TDS2)

1 In the **Model Builder** window, under **Component 1 (comp1)** click **Transport of Diluted Species 2 (tds2)**.

2 In the **Settings** window for **Transport of Diluted Species**, click to expand the **Advanced Settings** section.

3 From the **Material balance form** list, choose **Conservative**.

Fluid 1

1 In the **Model Builder** window, under **Component 1 (comp1)** > **Transport of Diluted Species 2 (tds2)** click **Fluid 1**.

2 In the **Settings** window for **Fluid**, locate the **Convection** section.

3 Specify the \mathbf{u} vector as

v1	x
----	---

4 Locate the **Diffusion** section. From the list, choose **Diagonal**.

5 Specify the D_{e2C} matrix as

D_C	0	0
0	0	0
0	0	0

Initial Values 1

1 In the **Model Builder** window, click **Initial Values 1**.

2 In the **Settings** window for **Initial Values**, locate the **Initial Values** section.

3 In the $c2C$ text field, type c_{s0} .

Reactions 1

1 In the **Physics** toolbar, click  **Domains** and choose **Reactions**.

2 Select Domain 1 only.

3 In the **Settings** window for **Reactions**, locate the **Reaction Rates** section.

4 In the R_{e2C} text field, type $-(4/H) * c2_C * v_m$.

Concentration 1

1 In the **Physics** toolbar, click  **Boundaries** and choose **Concentration**.

2 Select Boundary 1 only.

3 In the **Settings** window for **Concentration**, locate the **Concentration** section.

4 Select the **Species $c2_C$** checkbox.

5 In the $c_{0,c2C}$ text field, type c_{s0} .

TRANSPORT OF DILUTED SPECIES 3 (TDS3)

1 In the **Model Builder** window, under **Component 1 (comp1)** click **Transport of Diluted Species 3 (tds3)**.

2 In the **Settings** window for **Transport of Diluted Species**, click to expand the **Advanced Settings** section.

3 From the **Material balance form** list, choose **Conservative**.

Fluid 1

- 1 In the **Model Builder** window, under **Component 1 (comp1) > Transport of Diluted Species 3 (tds3)** click **Fluid 1**.
- 2 In the **Settings** window for **Fluid**, locate the **Convection** section.
- 3 Specify the **u** vector as

v2	x
----	---

- 4 Locate the **Diffusion** section. From the list, choose **Diagonal**.
- 5 Specify the D_{e3O2} matrix as

D_O2	0	0
0	0	0
0	0	0

Reactions 1

- 1 In the **Physics** toolbar, click  **Domains** and choose **Reactions**.
- 2 Select Domain 1 only.
- 3 In the **Settings** window for **Reactions**, locate the **Reaction Rates** section.
- 4 In the R_{e3O2} text field, type $(4/H)*v_m*c1_{O2}$.
Compared to the inlet channel, there is no reaction source term in the outlet channel.

Outflow 1

- 1 In the **Physics** toolbar, click  **Boundaries** and choose **Outflow**.
- 2 Select Boundary 5 only.

DARCY'S LAW (DL)

Fluid 1

- 1 In the **Model Builder** window, under **Component 1 (comp1) > Darcy's Law (dl) > Porous Medium 1** click **Fluid 1**.
- 2 In the **Settings** window for **Fluid**, locate the **Fluid Properties** section.
- 3 From the ρ list, choose **User defined**. In the associated text field, type rho1.
- 4 From the μ list, choose **User defined**. In the associated text field, type eta.

Porous Matrix 1

- 1 In the **Model Builder** window, click **Porous Matrix 1**.
- 2 In the **Settings** window for **Porous Matrix**, locate the **Matrix Properties** section.

- 3 From the ϵ_p list, choose **User defined**. In the associated text field, type 1.
- 4 From the κ list, choose **User defined**. In the associated text field, type $k_1 \cdot \epsilon_a$.

Mass Source 1

- 1 In the **Physics** toolbar, click  **Domains** and choose **Mass Source**.
- 2 In the **Settings** window for **Mass Source**, locate the **Domain Selection** section.
- 3 From the **Selection** list, choose **All domains**.
- 4 Locate the **Mass Source** section. In the Q_m text field, type $-\rho_1 \cdot (p_1 - p_2) \cdot a \cdot b / (a + b)$.

Pressure 1

- 1 In the **Physics** toolbar, click  **Boundaries** and choose **Pressure**.
- 2 Select Boundary 1 only.
- 3 In the **Settings** window for **Pressure**, locate the **Pressure** section.
- 4 In the p_0 text field, type p_{inlet} .

DARCY'S LAW 2 (DL2)

Fluid 1

- 1 In the **Model Builder** window, under **Component 1 (comp1) > Darcy's Law 2 (dl2) > Porous Medium 1** click **Fluid 1**.
- 2 In the **Settings** window for **Fluid**, locate the **Fluid Properties** section.
- 3 From the p list, choose **User defined**. In the associated text field, type ρ_2 .
- 4 From the μ list, choose **User defined**. In the associated text field, type ϵ_a .

Porous Matrix 1

- 1 In the **Model Builder** window, click **Porous Matrix 1**.
- 2 In the **Settings** window for **Porous Matrix**, locate the **Matrix Properties** section.
- 3 From the ϵ_p list, choose **User defined**. In the associated text field, type 1.
- 4 From the κ list, choose **User defined**. In the associated text field, type $k_1 \cdot \epsilon_a$.

Mass Source 1

- 1 In the **Physics** toolbar, click  **Domains** and choose **Mass Source**.
- 2 Select Domain 1 only.
- 3 In the **Settings** window for **Mass Source**, locate the **Mass Source** section.
- 4 In the Q_m text field, type $\rho_2 \cdot (p_1 - p_2) \cdot a \cdot b / (a + b)$.

Pressure 1

- 1 In the **Physics** toolbar, click  **Boundaries** and choose **Pressure**.
- 2 Select Boundary 5 only.
- 3 In the **Settings** window for **Pressure**, locate the **Pressure** section.
- 4 In the p_0 text field, type `p_outlet`.

HEAT TRANSFER IN FLUIDS (HT)

Fluid 1

- 1 In the **Model Builder** window, under **Component 1 (comp1) > Heat Transfer in Fluids (ht)** click **Fluid 1**.
- 2 In the **Settings** window for **Fluid**, locate the **Heat Convection** section.
- 3 Specify the **u** vector as

v_1	x
-------	-----

- 4 Locate the **Heat Conduction, Fluid** section. From the k list, choose **User defined**. From the list, choose **Diagonal**.
- 5 Specify the k matrix as

k_{gas}	0	0
0	0	0
0	0	0

- 6 Locate the **Thermodynamics, Fluid** section. From the **Fluid type** list, choose **Gas/Liquid**.
- 7 From the ρ list, choose **User defined**. In the associated text field, type `rho1`.
- 8 From the C_p list, choose **User defined**. In the associated text field, type `Cp_gas`.
- 9 From the γ list, choose **User defined**.

Initial Values 1

- 1 In the **Model Builder** window, click **Initial Values 1**.
- 2 In the **Settings** window for **Initial Values**, locate the **Initial Values** section.
- 3 In the T_1 text field, type `T0`.

Heat Source 1

- 1 In the **Physics** toolbar, click  **Domains** and choose **Heat Source**.

The heat source is contributed by the fluid flow and the heat transfer caused by the temperature difference between the inlet channel and the soot layer (or membrane).

- 2 Select Domain 1 only.
- 3 In the **Settings** window for **Heat Source**, locate the **Heat Source** section.
- 4 In the Q_0 text field, type $-(4/H)*rho1*Cp_gas*T1*v_m-(4/H)*ht_fg*(T1-Tm)$.

Temperature 1

- 1 In the **Physics** toolbar, click  **Boundaries** and choose **Temperature**.
- 2 Select Boundary 1 only.
- 3 In the **Settings** window for **Temperature**, locate the **Temperature** section.
- 4 In the T_0 text field, type T_inlet .

HEAT TRANSFER IN FLUIDS 2 (HT2)

Fluid 1

- 1 In the **Model Builder** window, under **Component 1 (comp1)** > **Heat Transfer in Fluids 2 (ht2)** click **Fluid 1**.
- 2 In the **Settings** window for **Fluid**, locate the **Heat Conduction, Fluid** section.
- 3 From the k list, choose **User defined**. From the list, choose **Diagonal**.
- 4 Specify the k matrix as

k_m	0	0
0	k_m*ani_m	0
0	0	k_m*ani_m

- 5 Locate the **Thermodynamics, Fluid** section. From the **Fluid type** list, choose **Gas/Liquid**.
- 6 From the ρ list, choose **User defined**. In the associated text field, type rho_m .
- 7 From the C_p list, choose **User defined**. In the associated text field, type Cp_m .
- 8 From the γ list, choose **User defined**.

Initial Values 1

- 1 In the **Model Builder** window, click **Initial Values 1**.
- 2 In the **Settings** window for **Initial Values**, locate the **Initial Values** section.
- 3 In the Tm text field, type $T0$.

Heat Source 1

- 1 In the **Physics** toolbar, click  **Domains** and choose **Heat Source**.
- 2 Select Domain 1 only.
- 3 In the **Settings** window for **Heat Source**, locate the **Heat Source** section.

- 4 In the Q_0 text field, type $(\text{chem.Qs}+(\rho_01*T1-\rho_02*T2)*Cp_gas*v_m-ht_fg*(2*Tm-T1-T2))/d_m$.

The heat source is determined by fluid inflow from the inlet channel, fluid outflow to the outlet channel, and heat transfer caused by the temperature differences between the soot layer, inlet channel, and outlet channel.

Heat Flux 1

- 1 In the **Physics** toolbar, click  **Boundaries** and choose **Heat Flux**.
- 2 Select Boundary 1 only.
- 3 In the **Settings** window for **Heat Flux**, locate the **Heat Flux** section.
- 4 In the q_0 text field, type $-ht_fg*(Tm-T1)$.

Heat Flux 2

- 1 In the **Physics** toolbar, click  **Boundaries** and choose **Heat Flux**.
- 2 Select Boundary 4 only.
- 3 In the **Settings** window for **Heat Flux**, locate the **Heat Flux** section.
- 4 In the q_0 text field, type $-ht_fa*(Tm-T_amb)$.

Heat Flux 3

- 1 In the **Physics** toolbar, click  **Boundaries** and choose **Heat Flux**.
- 2 Select Boundary 5 only.
- 3 In the **Settings** window for **Heat Flux**, locate the **Heat Flux** section.
- 4 In the q_0 text field, type $-ht_fg*(Tm-T2)$.

HEAT TRANSFER IN FLUIDS 3 (HT3)

Fluid 1

- 1 In the **Model Builder** window, under **Component 1 (comp1)** > **Heat Transfer in Fluids 3 (ht3)** click **Fluid 1**.
- 2 In the **Settings** window for **Fluid**, locate the **Heat Convection** section.
- 3 Specify the **u** vector as

$$\begin{array}{|c|c|} \hline v2 & x \\ \hline \end{array}$$

- 4 Locate the **Heat Conduction, Fluid** section. From the k list, choose **User defined**. From the list, choose **Diagonal**.

5 Specify the k matrix as

k_gas	0	0
0	0	0
0	0	0

6 Locate the **Thermodynamics, Fluid** section. From the **Fluid type** list, choose **Gas/Liquid**.

7 From the ρ list, choose **User defined**. In the associated text field, type rho2.

8 From the C_p list, choose **User defined**. In the associated text field, type Cp_gas.

9 From the γ list, choose **User defined**.

Initial Values I

1 In the **Model Builder** window, click **Initial Values I**.

2 In the **Settings** window for **Initial Values**, locate the **Initial Values** section.

3 In the T_2 text field, type T0.

Heat Source I

1 In the **Physics** toolbar, click  **Domains** and choose **Heat Source**.

2 Select Domain 1 only.

3 In the **Settings** window for **Heat Source**, locate the **Heat Source** section.

4 In the Q_0 text field, type $(4/H) * \rho_{02} * C_{p_gas} * T_m * v_m - (4/H) * h_{t_fg} * (T_2 - T_m)$.

Outflow I

1 In the **Physics** toolbar, click  **Boundaries** and choose **Outflow**.

2 Select Boundary 5 only.

GENERAL FORM PDE (G)

General Form PDE I

1 In the **Model Builder** window, under **Component 1 (comp1) > General Form PDE (g)** click **General Form PDE I**.

2 In the **Settings** window for **General Form PDE**, locate the **Conservative Flux** section.

3 Specify the Γ vector as

$-D_{s1} \cdot dsx$	x
$-D_{s1} \cdot dsy$	y
$-D_{s1} \cdot dsz$	z

Here, dsx , dsy , and dsz are the ds gradients along the x , y , and z directions, respectively.

4 Locate the **Source Term** section. In the f text field, type $(chem.Rsurf_C+c2_C*v_m)*M_s/rho_s$.

Initial Values 1

- 1 In the **Model Builder** window, click **Initial Values 1**.
- 2 In the **Settings** window for **Initial Values**, locate the **Initial Values** section.
- 3 In the ds text field, type $ds0$.

MESH 1

Free Triangular 1

- 1 In the **Mesh** toolbar, click  **More Generators** and choose **Free Triangular**.
- 2 Select Boundary 1 only.

Size 1

- 1 Right-click **Free Triangular 1** and choose **Size**.
- 2 In the **Settings** window for **Size**, locate the **Element Size** section.
- 3 From the **Predefined** list, choose **Finer**.

Boundary Layers 1

- 1 In the **Mesh** toolbar, click  **Boundary Layers**.
- 2 In the **Settings** window for **Boundary Layers**, locate the **Geometric Entity Selection** section.
- 3 From the **Geometric entity level** list, choose **Boundary**.
- 4 Select Boundary 1 only.

Boundary Layer Properties



- 1 In the **Model Builder** window, click **Boundary Layer Properties**.
- 2 Select Edge 4 only.
- 3 In the **Settings** window for **Boundary Layer Properties**, locate the **Layers** section.

- 4 In the **Number of layers** text field, type 3.
- 5 In the **Stretching factor** text field, type 2.

Swept 1

In the **Mesh** toolbar, click  **Swept**.

Distribution 1

- 1 Right-click **Swept 1** and choose **Distribution**.
- 2 In the **Settings** window for **Distribution**, locate the **Distribution** section.
- 3 From the **Distribution type** list, choose **Predefined**.
- 4 In the **Number of elements** text field, type 40.
- 5 In the **Element ratio** text field, type 0.1.
- 6 Select the **Symmetric distribution** checkbox.
- 7 Select the **Reverse direction** checkbox.
- 8 Click  **Build All**.
- 9 Click the  **Zoom Extents** button in the **Graphics** toolbar.

This should generate the mesh shown in [Figure 5](#).

STUDY 1

In the stationary study step, disable the **General Form PDE** interface to hold the soot-layer thickness constant.

Step 1: Stationary

- 1 In the **Model Builder** window, under **Study 1** click **Step 1: Stationary**.
- 2 In the **Settings** window for **Stationary**, locate the **Physics and Variables Selection** section.
- 3 In the **Solve for** column of the table, under **Component 1 (comp1)**, clear the checkbox for **General Form PDE (g)**.



Step 2: Time Dependent

Add a **Time Dependent** study step to investigate the fully coupled transient problem, accounting for the varying soot-layer thickness.

- 1 In the **Study** toolbar, click  **Time Dependent**.
- 2 In the **Settings** window for **Time Dependent**, locate the **Study Settings** section.
- 3 In the **Output times** text field, type range (0,90,900).



Parametric Sweep







Add a **Parametric Sweep** to study the model with ($Rs_factor=1$) and without ($Rs_factor=0$) oxidation reaction.

- 1 In the **Study** toolbar, click  **Parametric Sweep**.
- 2 In the **Settings** window for **Parametric Sweep**, locate the **Study Settings** section.
- 3 Click  **Add**.
- 4 In the table, enter the following settings:





Parameter name	Parameter value list	Parameter unit
Rs_factor (Factor of the oxidation reaction rate)	0 1	

Solution I (sol1)

- 1 In the **Study** toolbar, click  **Show Default Solver**.
- 2 In the **Model Builder** window, expand the **Solution I (sol1)** node.
- 3 In the **Model Builder** window, expand the **Study I > Solver Configurations > Solution I (sol1) > Stationary Solver I** node, then click **Direct**.
- 4 In the **Settings** window for **Direct**, locate the **General** section.
- 5 From the **Solver** list, choose **PARDISO**.
- 6 In the **Model Builder** window, expand the **Study I > Solver Configurations > Solution I (sol1) > Stationary Solver I > Segregated I** node.
 - 1 In the **Model Builder** window, under **Study I > Solver Configurations > Solution I (sol1) > Stationary Solver I > Segregated I**, Ctrl-click to select **Temperature**, **Temperature (2)**, **Temperature (3)**, and **Concentration C1_O2**.
 - 2 Right-click and choose **Delete**.
 - 1 In the **Settings** window for **Segregated Step**, type Segregated Step 3 in the **Label** text field.
 - 2 In the **Model Builder** window, under **Study I > Solver Configurations > Solution I (sol1) > Stationary Solver I > Segregated I** click **Concentration C3_O2**.
 - 3 In the **Settings** window for **Segregated Step**, type Segregated Step 4 in the **Label** text field.
 - 4 In the **Model Builder** window, click **Pressure P1**.
 - 5 In the **Settings** window for **Segregated Step**, locate the **General** section.
 - 6 Under **Variables**, click  **Add**.

- 7 In the **Add** dialog, select **Pressure (comp1.p2)** in the **Variables** list.
- 8 Click **OK**.
- 9 In the **Model Builder** window, click **Pressure P2**.
- 10 In the **Settings** window for **Segregated Step**, locate the **General** section.
- 11 In the **Variables** list box, select **Pressure (comp1.p2)**.
- 12 Under **Variables**, click  **Delete**.
- 13 Under **Variables**, click  **Add**.
- 14 In the **Add** dialog, in the **Variables** list, choose **Temperature (comp1.T1)**, **Temperature (comp1.T2)**, and **Temperature (comp1.Tm)**.
- 15 Click **OK**.
- 16 In the **Settings** window for **Segregated Step**, click to expand the **Method and Termination** section.
- 17 In the **Damping factor** text field, type 0.9.
- 18 In the **Model Builder** window, click **Segregated Step 3**.
- 19 In the **Settings** window for **Segregated Step**, locate the **General** section.
- 20 In the **Variables** list box, select **Concentration (comp1.c2_C)**.
- 21 Under **Variables**, click  **Delete**.
- 22 Under **Variables**, click  **Add**.
- 23 In the **Add** dialog, in the **Variables** list, choose **Concentration (comp1.c1_02)** and **Concentration (comp1.c3_02)**.
- 24 Click **OK**.
- 25 In the **Settings** window for **Segregated Step**, locate the **General** section.
- 26 From the **Linear solver** list, choose **Direct, pressure (dl)**.
- 27 Locate the **Method and Termination** section. In the **Damping factor** text field, type 0.9.
- 28 In the **Model Builder** window, click **Segregated Step 4**.
- 29 In the **Settings** window for **Segregated Step**, locate the **General** section.
- 30 In the **Variables** list box, select **Concentration (comp1.c3_02)**.
- 31 Under **Variables**, click  **Delete**.
- 32 Under **Variables**, click  **Add**.
- 33 In the **Add** dialog, select **Concentration (comp1.c2_C)** in the **Variables** list.
- 34 Click **OK**.
- 35 In the **Settings** window for **Segregated Step**, locate the **General** section.

- 36 From the **Linear solver** list, choose **Direct, pressure (dl)**.
- 37 Locate the **Method and Termination** section. In the **Damping factor** text field, type 1.
- 38 In the **Model Builder** window, click **Lower Limit 1**.
- 39 In the **Settings** window for **Lower Limit**, locate the **Lower Limit** section.
- 40 In the **Lower limits (field variables)** text field, type comp1.T1 200 comp1.T2 200
comp1.Tm 200.
- 41 In the **Model Builder** window, expand the **Study 1 > Solver Configurations > Solution 1 (sol1) > Time-Dependent Solver 1** node, then click **Direct**.
- 42 In the **Settings** window for **Direct**, locate the **General** section.
- 43 From the **Solver** list, choose **PARDISO**.
- 44 In the **Model Builder** window, expand the **Study 1 > Solver Configurations > Solution 1 (sol1) > Time-Dependent Solver 1 > Segregated 1** node.
- 1 In the **Model Builder** window, under **Study 1 > Solver Configurations > Solution 1 (sol1) > Time-Dependent Solver 1 > Segregated 1**, Ctrl-click to select **Temperature, Temperature (2), Temperature (3), and Concentration C1_02**.
- 2 Right-click and choose **Delete**.
- 1 In the **Settings** window for **Segregated Step**, type Segregated Step 4 in the **Label** text field.
- 2 In the **Model Builder** window, under **Study 1 > Solver Configurations > Solution 1 (sol1) > Time-Dependent Solver 1 > Segregated 1** click **Concentration C3_02**.
- 3 In the **Settings** window for **Segregated Step**, type Segregated Step 5 in the **Label** text field.
- 4 In the **Model Builder** window, click **Pressure P1**.
- 5 In the **Settings** window for **Segregated Step**, locate the **General** section.
- 6 Under **Variables**, click **+ Add**.
- 7 In the **Add** dialog, select **Pressure (comp1.p2)** in the **Variables** list.
- 8 Click **OK**.
- 9 In the **Model Builder** window, click **Pressure P2**.
- 10 In the **Settings** window for **Segregated Step**, locate the **General** section.
- 11 In the **Variables** list box, select **Pressure (comp1.p2)**.
- 12 Under **Variables**, click  **Delete**.
- 13 Under **Variables**, click **+ Add**.

- 14 In the **Add** dialog, in the **Variables** list, choose **Temperature (comp1.T1)**, **Temperature (comp1.T2)**, and **Temperature (comp1.Tm)**.
- 15 Click **OK**.
- 16 In the **Settings** window for **Segregated Step**, click to expand the **Method and Termination** section.
- 17 In the **Damping factor** text field, type 0.7.
- 18 In the **Model Builder** window, click **General Form PDE**.
- 19 In the **Settings** window for **Segregated Step**, locate the **General** section.
- 20 In the **Variables** list box, select **Dependent Variable Ds (comp1.ds)**.
- 21 Under **Variables**, click  **Delete**.
- 22 Under **Variables**, click  **Add**.
- 23 In the **Add** dialog, in the **Variables** list, choose **Concentration (comp1.c1_02)** and **Concentration (comp1.c3_02)**.
- 24 Click **OK**.
- 25 In the **Settings** window for **Segregated Step**, locate the **Method and Termination** section.
- 26 In the **Damping factor** text field, type 0.7.
- 27 In the **Number of iterations** text field, type 2.
- 28 In the **Model Builder** window, click **Segregated Step 5**.
- 29 In the **Settings** window for **Segregated Step**, locate the **General** section.
- 30 In the **Variables** list box, select **Concentration (comp1.c3_02)**.
- 31 Under **Variables**, click  **Delete**.
- 32 Under **Variables**, click  **Add**.
- 33 In the **Add** dialog, select **Dependent Variable Ds (comp1.ds)** in the **Variables** list.
- 34 Click **OK**.
- 35 In the **Settings** window for **Segregated Step**, locate the **General** section.
- 36 From the **Linear solver** list, choose **Direct, pressure (dl)**.
- 37 Locate the **Method and Termination** section. In the **Damping factor** text field, type 1.
- 38 In the **Model Builder** window, click **Lower Limit 1**.
- 39 In the **Settings** window for **Lower Limit**, locate the **Lower Limit** section.
- 40 In the **Lower limits (field variables)** text field, type `comp1.T1 200 comp1.T2 200 comp1.Tm 200`.
- 41 In the **Model Builder** window, click **Study 1**.

42 In the **Settings** window for **Study**, locate the **Study Settings** section.

43 Clear the **Generate default plots** checkbox.

44 In the **Study** toolbar, click  **Compute**.

RESULTS

Gas velocity, inlet

1 In the **Home** toolbar, click  **Add Plot Group** and choose **3D Plot Group**.

2 In the **Settings** window for **3D Plot Group**, type `Gas velocity, inlet` in the **Label** text field.

3 Locate the **Data** section. From the **Time (s)** list, choose **0**.

4 Click to expand the **Title** section. From the **Title type** list, choose **Manual**.

5 In the **Title** text area, type `Time=0 s, Surface: velocity(m/s), with oxidation`.

Surface 1

1 Right-click **Gas velocity, inlet** and choose **Surface**.

2 In the **Settings** window for **Surface**, locate the **Expression** section.

3 In the **Expression** text field, type `d1.U`.

4 In the **Gas velocity, inlet** toolbar, click  **Plot**.

5 Click the  **Zoom Extents** button in the **Graphics** toolbar.

Gas velocity, outlet

1 In the **Home** toolbar, click  **Add Plot Group** and choose **3D Plot Group**.

2 In the **Settings** window for **3D Plot Group**, type `Gas velocity, outlet` in the **Label** text field.

3 Locate the **Data** section. From the **Time (s)** list, choose **0**.

4 Locate the **Title** section. From the **Title type** list, choose **Manual**.

5 In the **Title** text area, type `Time=0 s, Surface: velocity(m/s), with oxidation`.

Surface 1

1 Right-click **Gas velocity, outlet** and choose **Surface**.

2 In the **Settings** window for **Surface**, locate the **Expression** section.

3 In the **Expression** text field, type `d12.U`.

4 In the **Gas velocity, outlet** toolbar, click  **Plot**.

Concentration, O2, inlet

1 In the **Home** toolbar, click  **Add Plot Group** and choose **3D Plot Group**.

- 2 In the **Settings** window for **3D Plot Group**, type Concentration, O₂, inlet in the **Label** text field.

Slice 1

- 1 Right-click **Concentration, O₂, inlet** and choose **Slice**.
- 2 In the **Concentration, O₂, inlet** toolbar, click  **Plot**.

Concentration, C, membrane

- 1 In the **Home** toolbar, click  **Add Plot Group** and choose **3D Plot Group**.
- 2 In the **Settings** window for **3D Plot Group**, type Concentration, C, membrane in the **Label** text field.

Slice 1

- 1 Right-click **Concentration, C, membrane** and choose **Slice**.
- 2 In the **Settings** window for **Slice**, click **Replace Expression** in the upper-right corner of the **Expression** section. From the menu, choose **Component 1 (comp1) > Transport of Diluted Species 2 > Species c2_C > c2_C - Molar concentration, c2_C - mol/m³**.
- 3 In the **Concentration, C, membrane** toolbar, click  **Plot**.

Concentration, O₂, outlet

- 1 In the **Home** toolbar, click  **Add Plot Group** and choose **3D Plot Group**.
- 2 In the **Settings** window for **3D Plot Group**, type Concentration, O₂, outlet in the **Label** text field.

Slice 1

- 1 Right-click **Concentration, O₂, outlet** and choose **Slice**.
- 2 In the **Settings** window for **Slice**, locate the **Expression** section.
- 3 In the **Expression** text field, type c3_O₂.
- 4 In the **Concentration, O₂, outlet** toolbar, click  **Plot**.

Temperature, T_m, no oxidation



- 1 In the **Home** toolbar, click  **Add Plot Group** and choose **3D Plot Group**.

The following steps create [Figure 8](#).

- 2 In the **Settings** window for **3D Plot Group**, type Temperature, T_m, no oxidation in the **Label** text field.
- 3 Locate the **Data** section. From the **Dataset** list, choose **Study 1/ Parametric Solutions 1 (sol3)**.
- 4 From the **Parameter value (Rs_factor)** list, choose **0**.

- 5 Locate the **Title** section. From the **Title type** list, choose **Manual**.
- 6 In the **Title** text area, type Time=900 s Surface: Temperature (K), without oxidation.



Surface 1

- 1 Right-click **Temperature, Tm, no oxidation** and choose **Surface**.
- 2 In the **Settings** window for **Surface**, locate the **Expression** section.
- 3 In the **Expression** text field, type Tm.
- 4 In the **Temperature, Tm, no oxidation** toolbar, click  **Plot**.
- 5 Click the  **Zoom Extents** button in the **Graphics** toolbar.

Temperature, Tm, with oxidation

- 1 In the **Home** toolbar, click  **Add Plot Group** and choose **3D Plot Group**.
- 2 In the **Settings** window for **3D Plot Group**, type Temperature, Tm, with oxidation in the **Label** text field.
- 3 Locate the **Title** section. From the **Title type** list, choose **Manual**.
- 4 In the **Title** text area, type Time=900 s Surface: Temperature (K), with oxidation.



Surface 1

- 1 Right-click **Temperature, Tm, with oxidation** and choose **Surface**.
- 2 In the **Settings** window for **Surface**, locate the **Expression** section.
- 3 In the **Expression** text field, type Tm.
- 4 In the **Temperature, Tm, with oxidation** toolbar, click  **Plot**.
- 5 Click the  **Zoom Extents** button in the **Graphics** toolbar.

Pressure difference along the centerline, without oxidation reaction

- 1 In the **Home** toolbar, click  **Add Plot Group** and choose **ID Plot Group**.
- 2 In the **Settings** window for **ID Plot Group**, type Pressure difference along the centerline, without oxidation reaction in the **Label** text field.
- 3 Locate the **Data** section. From the **Dataset** list, choose **Study 1/ Parametric Solutions 1 (sol3)**.
- 4 From the **Parameter selection (Rs_factor)** list, choose **From list**.
- 5 In the **Parameter values (Rs_factor)** list box, select **0**.
- 6 From the **Time selection** list, choose **From list**.
- 7 In the **Times (s)** list box, select **0**.

Line Graph 1

- 1 Right-click **Pressure difference along the centerline, without oxidation reaction** and choose **Line Graph**.
- 2 Select Edge 3 only.
- 3 In the **Settings** window for **Line Graph**, locate the **y-Axis Data** section.
- 4 In the **Expression** text field, type p1 - p2.
- 5 In the **Pressure difference along the centerline, without oxidation reaction** toolbar, click  **Plot**.
- 6 Click the  **Zoom Extents** button in the **Graphics** toolbar.



Soot layer thickness along the centerline, without oxidation reaction

- 1 In the **Model Builder** window, right-click **Pressure difference along the centerline, without oxidation reaction** and choose **Duplicate**.
- 2 In the **Settings** window for **ID Plot Group**, type Soot layer thickness along the centerline, without oxidation reaction in the **Label** text field.
- 3 Locate the **Data** section. From the **Time selection** list, choose **All**.

Line Graph 1

- 1 In the **Model Builder** window, expand the **Soot layer thickness along the centerline, without oxidation reaction** node, then click **Line Graph 1**.
- 2 In the **Settings** window for **Line Graph**, locate the **y-Axis Data** section.
- 3 In the **Expression** text field, type ds.
- 4 From the **Unit** list, choose **µm**.

Color Expression 1

- 1 Right-click **Line Graph 1** and choose **Color Expression**.
- 2 In the **Settings** window for **Color Expression**, locate the **Expression** section.
- 3 In the **Expression** text field, type t.
- 4 Click to expand the **Title** section. From the **Title type** list, choose **Automatic**.
- 5 Click to expand the **Coloring and Style** section. From the **Color table** list, choose **SpectrumClassic**.
- 6 In the **Soot layer thickness along the centerline, without oxidation reaction** toolbar, click  **Plot**.
- 7 Click the  **Zoom Extents** button in the **Graphics** toolbar.
- 8 Right-click **Color Expression 1** and choose **Copy**.

The following steps create [Figure 9](#) and [Figure 10](#).



Soot layer ds, along the top line

- 1 In the **Home** toolbar, click  **Add Plot Group** and choose **ID Plot Group**.
- 2 In the **Settings** window for **ID Plot Group**, type Soot layer ds, along the top line in the **Label** text field.

Line Graph 1

- 1 Right-click **Soot layer ds, along the top line** and choose **Line Graph**.
- 2 Select Edge 5 only.
- 3 In the **Settings** window for **Line Graph**, locate the **y-Axis Data** section.
- 4 In the **Expression** text field, type ds.



Color Expression 1

- 1 Right-click **Line Graph 1** and choose **Paste Color Expression**.
- 2 In the **Soot layer ds, along the top line** toolbar, click  **Plot**.
- 3 Click the  **Zoom Extents** button in the **Graphics** toolbar.

Soot layer ds, along the centerline

- 1 In the **Model Builder** window, right-click **Soot layer ds, along the top line** and choose **Duplicate**.
- 2 In the **Settings** window for **ID Plot Group**, type Soot layer ds, along the centerline in the **Label** text field.

Line Graph 1

- 1 In the **Model Builder** window, expand the **Soot layer ds, along the centerline** node, then click **Line Graph 1**.
- 2 In the **Settings** window for **Line Graph**, locate the **Selection** section.
- 3 Click to select the  **Activate Selection** toggle button.
- 4 In the list box, select **5**.
- 5 Select Edge 3 only.
- 6 In the **Soot layer ds, along the centerline** toolbar, click  **Plot**.

Pressure difference p1-p2, along the centerline 1

- 1 In the **Model Builder** window, right-click **Soot layer ds, along the centerline** and choose **Duplicate**.
- 2 In the **Settings** window for **ID Plot Group**, type Pressure difference p1-p2, along the centerline 1 in the **Label** text field.

Line Graph 1

- 1** In the **Model Builder** window, expand the **Pressure difference p1-p2, along the centerline 1** node, then click **Line Graph 1**.
- 2** In the **Settings** window for **Line Graph**, locate the **y-Axis Data** section.
- 3** In the **Expression** text field, type $p1 - p2$.
- 4** In the **Pressure difference p1-p2, along the centerline 1** toolbar, click  **Plot**.