



Model created in COMSOL Multiphysics 6.4

Water Purification Reactor

Introduction

Water purification for turning natural water into drinking water is a process constituted of several steps. At least one step must be a disinfectant step. One way to achieve efficient disinfection in an environmentally friendly way is to use ozone. A typical ozone purification reactor is about 40 m long and resembles a maze with partial walls or baffles that divide the space into room-sized compartments (Ref. 1). When water flows through the reactor turbulent flow is created along its winding path around the baffles toward the exit pipe. The turbulence mixes the water with ozone gas that enters through diffusers just long enough to deactivate micropollutants. When the water leaves the reactor, the remaining purification steps filter off or otherwise remove the reacted pollutants.

When analyzing an ozone purification reactor, the first step is to get an overview of the turbulent flow field. The results from the turbulent-flow simulation can then be used for further analyses of residence time and chemical species transport and reactions by adding more physics to the model. The current model solves for turbulent flow in a water treatment reactor using the Turbulent Flow, k - ϵ interface.

Model Definition

MODEL GEOMETRY

The model geometry along with some boundary conditions are shown in [Figure 1](#). The full reactor has a symmetry plane which is utilized to reduce the size of the model.

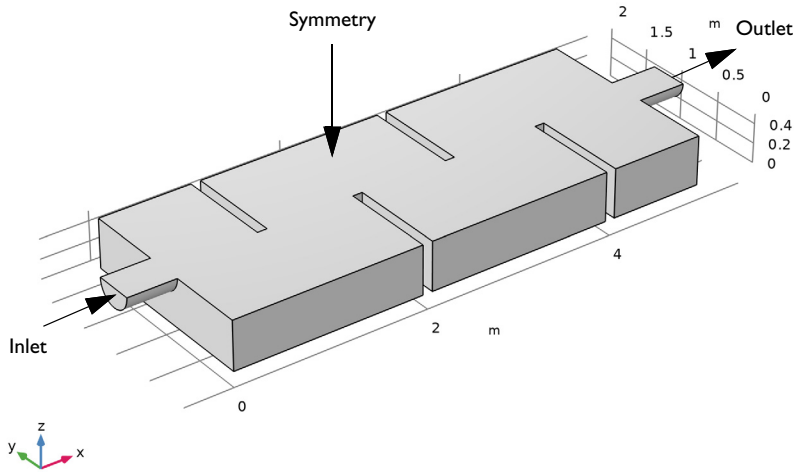

Figure 1: Model geometry. All boundaries except the inlet, outlet, and symmetry plane are walls.

DOMAIN EQUATIONS AND BOUNDARY CONDITIONS

Based on the inlet velocity and diameter, which in this case correspond to 0.1 m/s and 0.4 m respectively, the Reynolds number is

$$\text{Re} = \frac{U \cdot L}{\nu} = \frac{0.1 \cdot 0.4}{1 \cdot 10^{-6}} = 4 \cdot 10^5$$

Here ν is the kinematic viscosity. The high Reynolds number clearly indicates that the flow is turbulent. This means that the flow must be modeled using a turbulence model. In this case, the k - ϵ turbulence model is used, as it is often done in industrial applications, much because it is both relatively robust and computationally inexpensive compared to more advanced turbulence models. One major reason to why the k - ϵ model is inexpensive is that it makes use of wall functions to describe the flow close to walls instead of resolving the very steep gradients there. All boundaries in Figure 1, except the inlet, the outlet, and the symmetry plane, are walls.

The fully developed flow is used as inlet boundary condition. A constant pressure is prescribed on the outlet.

Notes About the COMSOL Implementation

Three-dimensional turbulent flows can take a rather long time to solve, even when using a turbulence models with wall functions. To make this tutorial feasible, the mesh is deliberately selected to be relatively coarse and the results are therefore not mesh independent. In any model, the effect of refining the mesh should be investigated in order to ensure that the model is well resolved.

Results and Discussion

Figure 2 shows the velocity field in the symmetry plane. The jet from the inlet hits the top of the first baffle which splits the jet. One half creates a strong recirculation zone in the first “chamber”. The other half continues down into the reactor and gradually spreads out. The velocity magnitude decreases as more fluid is entrained into the jet.

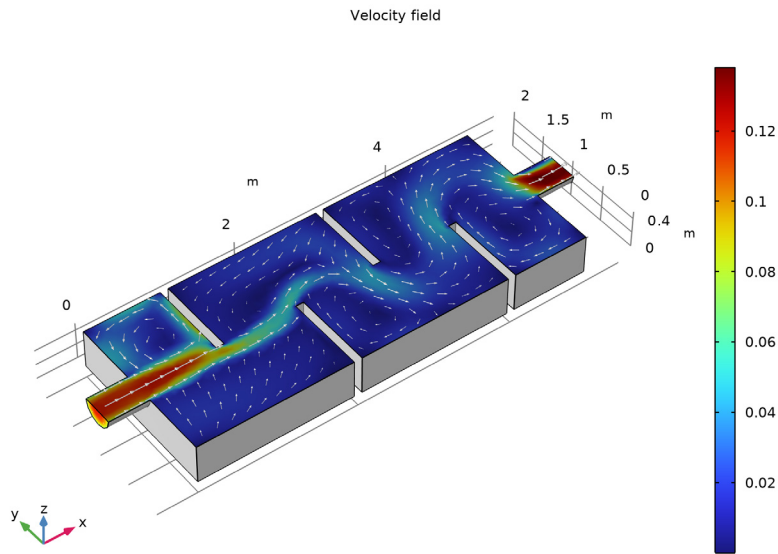

Figure 2: Velocity field in the symmetry plane.

Figure 3 gives a more complete picture of the mixing process in the reactor. The streamlines are colored by the velocity magnitude, and their width are proportional to the turbulent viscosity. Wide lines hence indicate high degree of mixing. The turbulence in this example is mainly produced in the shear layers between the central jet and the recirculation

zones. The mixing can be seen to be relatively weak in the beginning of the reactor. The plot also shows that it increases further downstream.

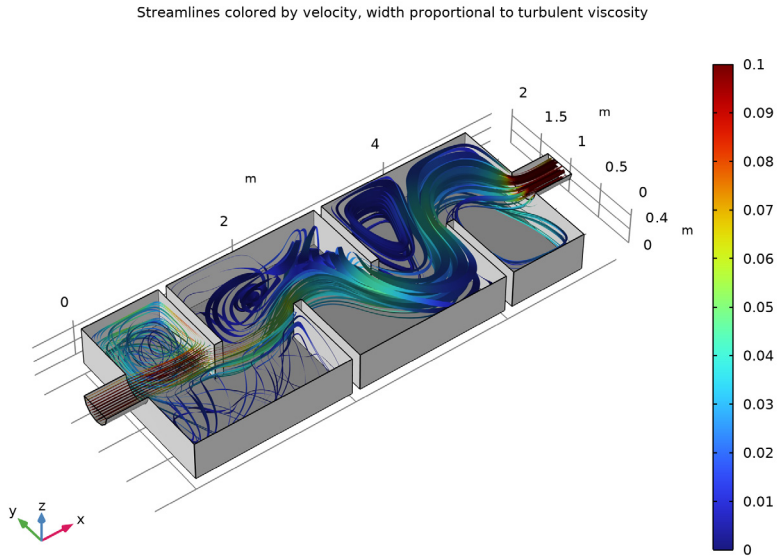

Figure 3: Streamlines colored by velocity. The width of the streamlines are proportional to the turbulent viscosity.

Reference

I. J. Hofman, D. Wind, B. Wols, W. Uijttewaal, H. van Dijk, and G. Stelling, “The use of CFD Modeling to determine the influence of residence time distribution on the disinfection of drinking water in ozone contactors,” *COMSOL Conference 2007*, Grenoble, 2007; www.comsol.com/story/fine-tuning-for-water-purification-22621

Application Library path: CFD_Module/Single-Phase_Flow/
water_purification_reactor



Modeling Instructions

From the **File** menu, choose **New**.

NEW

In the **New** window, click  **Model Wizard**.

MODEL WIZARD

- 1 In the **Model Wizard** window, click .
- 2 In the **Select Physics** tree, select **Fluid Flow** > **Single-Phase Flow** > **Turbulent Flow** > **Turbulent Flow, k- ϵ** (spf).
- 3 Click **Add**.
- 4 Click  **Study**.
- 5 In the **Select Study** tree, select **General Studies** > **Stationary**.
- 6 Click  **Done**.

GLOBAL DEFINITIONS

Parameters I

- 1 In the **Model Builder** window, under **Global Definitions** click **Parameters I**.
- 2 In the **Settings** window for **Parameters**, locate the **Parameters** section.
- 3 In the table, enter the following settings:

Name	Expression	Value	Description
u_in	0.1 [m/s]	0.1 m/s	Inlet velocity

GEOMETRY I

You can build the reactor geometry from geometric primitives. Here, instead, use a file containing the sequence of geometry features that has been provided for convenience.

- 1 In the **Geometry** toolbar, click **Insert Sequence** and choose **Insert Sequence**.
- 2 Browse to the model's Application Libraries folder and double-click the file `water_purification_reactor_geom_sequence.mph`.
- 3 In the **Geometry** toolbar, click  **Build All**.

The model geometry is now complete (Figure 1).

ADD MATERIAL

- 1 In the **Materials** toolbar, click  **Add Material** to open the **Add Material** window.

- 2 Go to the **Add Material** window.
- 3 In the tree, select **Built-in > Water, liquid**.
- 4 Click the **Add to Component** button in the window toolbar.
- 5 In the **Materials** toolbar, click  **Add Material** to close the **Add Material** window.

TURBULENT FLOW, K- ϵ (SPF)

Inlet 1

- 1 In the **Physics** toolbar, click  **Boundaries** and choose **Inlet**.
- 2 Select Boundary 1 only.
- 3 In the **Settings** window for **Inlet**, locate the **Boundary Condition** section.
- 4 From the list, choose **Fully developed flow**.
- 5 Locate the **Fully Developed Flow** section. In the U_{av} text field, type u_{in} .

Outlet 1

- 1 In the **Physics** toolbar, click  **Boundaries** and choose **Outlet**.
- 2 Select Boundary 28 only.

Symmetry 1

- 1 In the **Physics** toolbar, click  **Boundaries** and choose **Symmetry**.
- 2 In the **Settings** window for **Symmetry**, locate the **Boundary Selection** section.
- 3 From the **Selection** list, choose **Explicit Selection: Symmetry**.

MESH 1

- 1 In the **Model Builder** window, under **Component 1 (comp1)** click **Mesh 1**.
- 2 In the **Settings** window for **Mesh**, locate the **Physics-Controlled Mesh** section.
- 3 From the **Element size** list, choose **Coarser**.
- 4 Right-click **Component 1 (comp1) > Mesh 1** and choose **Edit Physics-Induced Sequence**.

Size 2

In the **Model Builder** window, under **Component 1 (comp1) > Mesh 1** right-click **Size 2** and choose **Disable**.

Boundary Layer Properties 1

- 1 In the **Model Builder** window, expand the **Component 1 (comp1) > Mesh 1 > Boundary Layers 1** node, then click **Boundary Layer Properties 1**.
- 2 In the **Settings** window for **Boundary Layer Properties**, locate the **Layers** section.

- 3 In the **Number of layers** text field, type 2.
- 4 In the **Thickness adjustment factor** text field, type 6.
- 5 In the **Model Builder** window, collapse the **Mesh 1** node.
- 6 In the **Model Builder** window, right-click **Mesh 1** and choose **Build All**.
- 7 Click the  **Zoom Extents** button in the **Graphics** toolbar.

Confirm that the mesh matches the figure below.

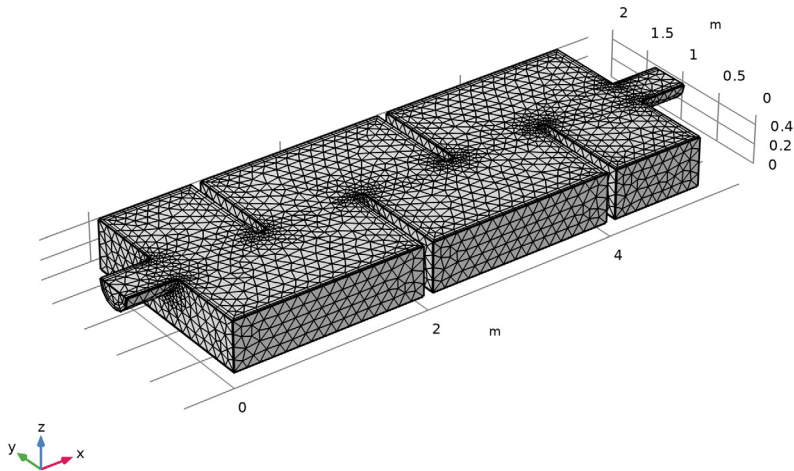

Next, solve for the flow field.

STUDY 1

In the **Study** toolbar, click  **Compute**.

RESULTS

The following steps reproduce [Figure 2](#) by modifying the default plot.

Velocity (spf)

- 1 In the **Model Builder** window, under **Results** click **Velocity (spf)**.
- 2 In the **Settings** window for **3D Plot Group**, click to expand the **Selection** section.
- 3 From the **Geometric entity level** list, choose **Boundary**.

- 4 Select Boundaries 1, 3, and 28 only. These are the symmetry plane, inlet, and outlet boundaries.

Multislice 1

- 1 In the **Model Builder** window, expand the **Velocity (spf)** node.
- 2 Right-click **Multislice 1** and choose **Delete**.

Surface 1

Right-click **Velocity (spf)** and choose **Surface**.

Arrow Surface 1

- 1 Right-click **Velocity (spf)** and choose **Arrow Surface**.
- 2 In the **Settings** window for **Arrow Surface**, locate the **Coloring and Style** section.
- 3 From the **Arrow length** list, choose **Logarithmic**.
- 4 Select the **Scale factor** checkbox. In the associated text field, type 1.4.
- 5 Locate the **Arrow Positioning** section. In the **Number of arrows** text field, type 300.
- 6 Locate the **Coloring and Style** section. From the **Color** list, choose **White**.

Surface 2

- 1 Right-click **Velocity (spf)** and choose **Surface**.
- 2 In the **Settings** window for **Surface**, locate the **Expression** section.
- 3 In the **Expression** text field, type 1.
- 4 Locate the **Coloring and Style** section. From the **Coloring** list, choose **Uniform**.
- 5 From the **Color** list, choose **Gray**.

Selection 1

- 1 Right-click **Surface 2** and choose **Selection**.
- 2 In the **Settings** window for **Selection**, locate the **Selection** section.
- 3 From the **Selection** list, choose **Box Selection: Walls**.

Velocity (spf)

- 1 In the **Model Builder** window, under **Results** click **Velocity (spf)**.
- 2 In the **Settings** window for **3D Plot Group**, click to expand the **Title** section.
- 3 From the **Title type** list, choose **Manual**.
- 4 In the **Title** text area, type **Velocity** field.
- 5 In the **Velocity (spf)** toolbar, click  **Plot**.

Proceed to reproduce [Figure 3](#) as follows.

3D Plot Group 4

In the **Results** toolbar, click  **3D Plot Group**.

Surface 1

- 1 Right-click **3D Plot Group 4** and choose **Surface**.
- 2 In the **Settings** window for **Surface**, locate the **Expression** section.
- 3 In the **Expression** text field, type 1.
- 4 Locate the **Coloring and Style** section. From the **Coloring** list, choose **Uniform**.
- 5 From the **Color** list, choose **Gray**.

Selection 1

- 1 Right-click **Surface 1** and choose **Selection**.
- 2 In the **Settings** window for **Selection**, locate the **Selection** section.
- 3 From the **Selection** list, choose **All boundaries**.
- 4 In the list, choose **1**, **3**, and **28**.
- 5 Click  **Remove from Selection**.
- 6 Select Boundaries 2 and 4–27 only.



Streamline 1

- 1 In the **Model Builder** window, right-click **3D Plot Group 4** and choose **Streamline**.
- 2 Select Boundary 1 only.
- 3 In the **Settings** window for **Streamline**, locate the **Streamline Positioning** section.
- 4 In the **Number** text field, type 45.
- 5 Locate the **Coloring and Style** section. Find the **Line style** subsection. From the **Type** list, choose **Ribbon**.
- 6 In the **Width expression** text field, type $\text{spf} \cdot \text{nuT} * 1 \text{ [s/m]}$.
- 7 Select the **Width scale factor** checkbox. In the associated text field, type 100.

Color Expression 1

- 1 Right-click **Streamline 1** and choose **Color Expression**.
- 2 In the **Settings** window for **Color Expression**, click to expand the **Range** section.
- 3 Select the **Manual color range** checkbox.
- 4 In the **Minimum** text field, type 0.
- 5 In the **Maximum** text field, type 0.1.

Streamlines

- 1 In the **Model Builder** window, under **Results** click **3D Plot Group 4**.
- 2 In the **Settings** window for **3D Plot Group**, locate the **Title** section.
- 3 From the **Title type** list, choose **Manual**.
- 4 In the **Title** text area, type Streamlines colored by velocity, width proportional to turbulent viscosity.
- 5 In the **3D Plot Group 4** toolbar, click  **Plot**.
- 6 Click the  **Zoom Extents** button in the **Graphics** toolbar.
- 7 In the **Label** text field, type Streamlines.