



Model created in COMSOL Multiphysics 6.4

Droplet Breakup in a T-Junction



Introduction

Emulsions consist of small liquid droplets immersed in another liquid, typically oil in water or water in oil. Emulsions find wide application in the production of food, cosmetics, and pharmaceutical products. The properties and quality of an emulsion typically depend on the size and the distribution of the droplets. This example studies in detail how to create uniform droplets in a microchannel T-junction.

Setting up the model you can make use of the multiphysics coupling feature Laminar Two-Phase Flow, Level Set interface. The model uses the multiphysics coupling wetted wall boundary condition at the solid walls, with a contact angle of 135° . From the results, you can determine the size of the created droplets and the rate with which they are produced.

Model Definition

Figure 1 shows the geometry of the T-shaped microchannel with a rectangular cross section. For the separated fluid elements to correspond to droplets, the geometry is modeled in 3D. Due to symmetry, it is sufficient to model only half of the junction geometry. The modeling domain is shown in Figure 1. The fluid to be dispersed into small droplets, Fluid 2, enters through the vertical channel. The other fluid, Fluid 1, flows from the right to left through the horizontal channel.

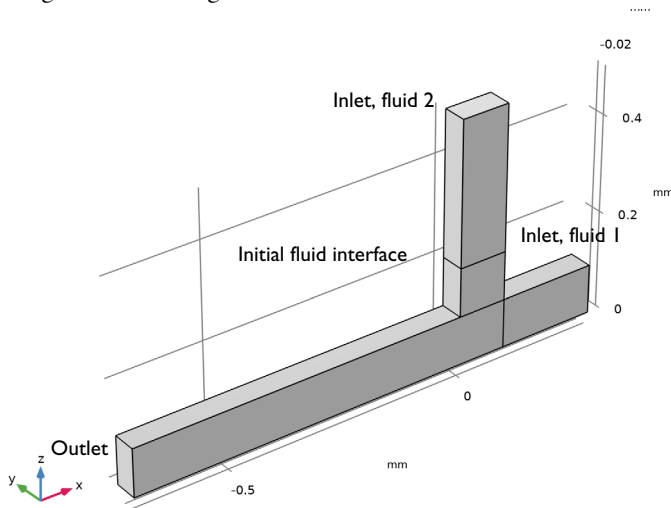

Figure 1: The modeling domain of the T-junction.

The problem described is straightforward to set up with the Laminar Two-Phase Flow, Level Set multiphysics coupling feature. The feature couples the Laminar Flow and Level Set physics interfaces.

The Laminar Flow interface sets up a momentum transport equation and a continuity equation. The Level Set interface sets up a level set equation for the level-set variable. The fluid interface is defined by the 0.5 contour of the level-set function.

The Laminar Flow and Level Set interfaces use the following equations:

$$\rho \frac{\partial \mathbf{u}}{\partial t} + \rho(\mathbf{u} \cdot \nabla) \mathbf{u} = \nabla \cdot [-p \mathbf{I} + \mu(\nabla \mathbf{u} + (\nabla \mathbf{u})^T)] + \mathbf{F}_{st}$$

$$\nabla \cdot \mathbf{u} = 0$$

$$\frac{\partial \phi}{\partial t} + \mathbf{u} \cdot \nabla \phi = \gamma \nabla \cdot \left(-\phi(1-\phi) \frac{\nabla \phi}{|\nabla \phi|} + \varepsilon \nabla \phi \right)$$

In the equations above, ρ denotes density (kg/m^3), \mathbf{u} velocity (m/s), t time (s), μ dynamic viscosity ($\text{Pa}\cdot\text{s}$), p pressure (Pa), and \mathbf{F}_{st} the surface tension force (N/m^3). Furthermore, ϕ is the level-set function, and γ and ε are numerical stabilization parameters.

The effective density and viscosity are defined as volume averaged,

$$\rho = \rho_1 + (\rho_2 - \rho_1)\phi$$

$$\mu = \mu_1 + (\mu_2 - \mu_1)\phi$$

where ρ_1 , ρ_2 , μ_1 , and μ_2 are the densities and viscosities of Fluid 1 and Fluid 2, and the level-set function ϕ acts as the volume fraction of the second phase. Other definitions of the viscosity and pressure are also available. This model uses the Multiphase material to compute the effective material parameters.

PHYSICAL PARAMETERS

The two liquids have the following physical properties:

QUANTITY	VALUE, FLUID 1	VALUE, FLUID 2
Density (kg/m^3)	1000	1000
Dynamic viscosity ($\text{Pa}\cdot\text{s}$)	0.00195	0.00671

The surface tension coefficient is $5 \times 10^{-3} \text{ N}/\text{m}$.

BOUNDARY CONDITIONS

At both inlets, Fully developed flow conditions with prescribed volume flow rates are used. At the outflow boundary, the Pressure condition is set. The Wetted wall multiphysics boundary condition applies to all solid boundaries with the contact angle specified as 135° and a slip length equal to 6.5×10^{-5} m. The contact angle is the angle between the fluid interface and the solid wall at points where the fluid interface attaches to the wall. The slip length is the distance to the position outside the wall where the extrapolated tangential velocity component is zero (see Figure 2).

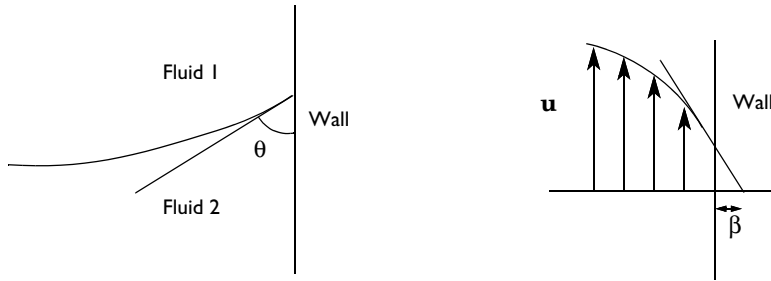

Figure 2: The contact angle, θ , and the slip length, β .

Results and Discussion

Figure 3 shows the fluid interface (the level-set function $\phi = 0.5$) and velocity streamlines at various times. The first droplet is formed after approximately 0.03 s.

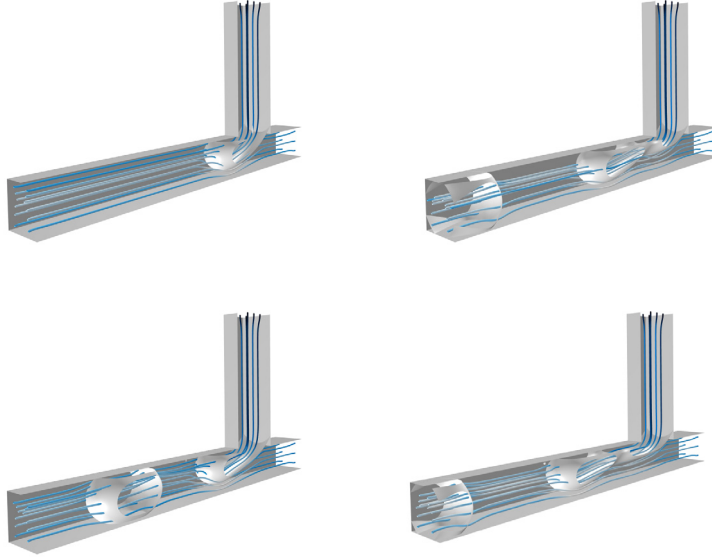

Figure 3: Velocity streamlines and the phase boundary at $t = 0.02$ s, 0.04 s, 0.06 s, and 0.08 s.

You can calculate the effective diameter, d_{eff} — that is, the diameter of a spherical droplet with the same volume as the formed droplet — using the following expression:

$$d_{\text{eff}} = 2 \cdot \sqrt[3]{\frac{3}{4\pi} \int_{\Omega} (\phi > 0.5) d\Omega} \quad (1)$$

Here, Ω represents the leftmost part of the horizontal channel, where $x < -0.2$ mm. In this case, the results show that d_{eff} is between 0.11 mm and 0.12 mm. The results are in fair agreement with those presented in [Ref. 1](#).

Reference

-
1. S. van der Graaf, T. Nisisako, C.G.P.H. Schroën, R.G.M. van der Sman, and R.M. Boom, “Lattice Boltzmann Simulations of Droplet Formation in a T-Shaped Microchannel,” *Langmuir*, vol. 22, pp. 4144–4152, 2006.

Application Library path: CFD_Module/Verification_Examples/droplet_breakup



Modeling Instructions

From the **File** menu, choose **New**.

NEW

In the **New** window, click  **Model Wizard**.



MODEL WIZARD

- 1 In the **Model Wizard** window, click  **3D**.
- 2 In the **Select Physics** tree, select **Fluid Flow** > **Multiphase Flow** > **Two-Phase Flow, Level Set** > **Laminar Flow**.
- 3 Click **Add**.
- 4 Click  **Study**.
- 5 In the **Select Study** tree, select **Preset Studies for Selected Multiphysics** > **Time Dependent with Phase Initialization**.
- 6 Click  **Done**.

GEOMETRY I

- 1 In the **Model Builder** window, under **Component 1 (comp1)** click **Geometry 1**.
- 2 In the **Settings** window for **Geometry**, locate the **Units** section.
- 3 From the **Length unit** list, choose **mm**.

Work Plane 1 (wp1)

- 1 In the **Geometry** toolbar, click  **Work Plane**.
- 2 In the **Settings** window for **Work Plane**, locate the **Plane Definition** section.
- 3 From the **Plane** list, choose **xz-plane**.
- 4 Click  **Go to Plane Geometry**.

Work Plane 1 (wp1) > Rectangle 1 (r1)

- 1 In the **Work Plane** toolbar, click  **Rectangle**.
- 2 In the **Settings** window for **Rectangle**, locate the **Size and Shape** section.
- 3 In the **Width** text field, type 0.1.

- 4 In the **Height** text field, type 0.4.
- 5 Locate the **Position** section. In the **yw** text field, type 0.1.

Work Plane 1 (wp1) > Rectangle 2 (r2)

- 1 In the **Work Plane** toolbar, click  **Rectangle**.
- 2 In the **Settings** window for **Rectangle**, locate the **Size and Shape** section.
- 3 In the **Height** text field, type 0.1.
- 4 Locate the **Position** section. In the **xw** text field, type -0.7.

Work Plane 1 (wp1) > Plane Geometry

In the **Work Plane** toolbar, click  **Build All**.

Work Plane 1 (wp1) > Polygon 1 (pol1)

- 1 In the **Work Plane** toolbar, click  **Polygon**.
- 2 In the **Settings** window for **Polygon**, locate the **Object Type** section.
- 3 From the **Type** list, choose **Open curve**.
- 4 Locate the **Coordinates** section. In the table, enter the following settings:

xw (mm)	yw (mm)
0	0.2
0.1	0.2

- 5 Click  **Build Selected**.

Work Plane 1 (wp1) > Polygon 2 (pol2)

- 1 In the **Work Plane** toolbar, click  **Polygon**.
- 2 In the **Settings** window for **Polygon**, locate the **Coordinates** section.
- 3 In the table, enter the following settings:

xw (mm)	yw (mm)
0.1	0
0.1	0.1

- 4 Click  **Build Selected**.

Extrude 1 (ext1)

- 1 In the **Model Builder** window, under **Component 1 (comp1) > Geometry 1** right-click **Work Plane 1 (wp1)** and choose **Extrude**.
- 2 In the **Settings** window for **Extrude**, locate the **Distances** section.

3 In the table, enter the following settings:

Distances (mm)
0.05

4 Click  **Build Selected**.

Form Union (fin)

1 In the **Model Builder** window, click **Form Union (fin)**.

2 In the **Settings** window for **Form Union/Assembly**, click  **Build Selected**.

The geometry should look like in [Figure 1](#).

MULTIPHYSICS

Two-Phase Flow, Level Set 1 (tpfl)

1 In the **Model Builder** window, under **Component 1 (comp1)** > **Multiphysics** click **Two-Phase Flow, Level Set 1 (tpfl)**.

2 In the **Settings** window for **Two-Phase Flow, Level Set**, locate the **Material Properties** section.

3 Click  **Add Multiphase Material**.

MATERIALS

Fluid 1

1 In the **Model Builder** window, under **Component 1 (comp1)** > **Materials** > **Multiphase Material 1 (mpmat1)** click **Phase 1 (mpmat1.phase1)**.

2 In the **Settings** window for **Phase**, type Fluid 1 in the **Label** text field.

3 Locate the **Material Contents** section. In the table, enter the following settings:

Property	Variable	Value	Unit	Property group
Density	rho	1e3 [kg/m ³]	kg/m ³	Basic
Dynamic viscosity	mu	1.95e-3 [Pa*s]	Pa*s	Basic

Fluid 2

1 In the **Model Builder** window, under **Component 1 (comp1)** > **Materials** > **Multiphase Material 1 (mpmat1)** click **Phase 2 (mpmat1.phase2)**.

2 In the **Settings** window for **Phase**, type Fluid 2 in the **Label** text field.

3 Locate the **Material Contents** section. In the table, enter the following settings:

Property	Variable	Value	Unit	Property group
Density	rho	1e3 [kg/m ³]	kg/m ³	Basic
Dynamic viscosity	mu	6.71e-3 [Pa*s]	Pa*s	Basic

DEFINITIONS

Step 1 (step1)

- 1 In the **Definitions** toolbar, click  **More Functions** and choose **Step**.
- 2 In the **Settings** window for **Step**, locate the **Parameters** section.
- 3 In the **Location** text field, type 1e-3.
- 4 Click to expand the **Smoothing** section. In the **Size of transition zone** text field, type 2e-3.

Integration 1 (intop1)

Add a nonlocal integration coupling that you will use to calculate the effective droplet diameter according to [Equation 1](#) in the **Model Definition** section.

- 1 In the **Definitions** toolbar, click  **Nonlocal Couplings** and choose **Integration**.
- 2 In the **Settings** window for **Integration**, locate the **Source Selection** section.
- 3 From the **Selection** list, choose **All domains**.

Variables 1

- 1 In the **Definitions** toolbar, click  **Local Variables**.
- 2 In the **Settings** window for **Variables**, locate the **Variables** section.
- 3 In the table, enter the following settings:

Name	Expression	Unit	Description
V1	0.4e-6/3600*step1(t[1/s])[m ³ /s]	m ³ /s	Volume flow, inlet 1
V2	0.2e-6/3600*step1(t[1/s])[m ³ /s]	m ³ /s	Volume flow, inlet 2
d_eff	2*(intop1((phils>0.5)*(x<-0.2[mm]))*3/(4*pi))^(1/3)	m	Effective droplet diameter

MULTIPHYSICS

Two-Phase Flow, Level Set 1 (tpfl)

- 1 In the **Model Builder** window, under **Component 1 (comp1) > Multiphysics** click **Two-Phase Flow, Level Set 1 (tpfl)**.
- 2 In the **Settings** window for **Two-Phase Flow, Level Set**, locate the **Surface Tension** section.
- 3 Select the **Include surface tension force in momentum equation** checkbox.
- 4 From the **Surface tension coefficient** list, choose **User defined**. In the σ text field, type $5e-3$ [N/m].

LEVEL SET (LS)

Level Set Model 1

- 1 In the **Model Builder** window, under **Component 1 (comp1) > Level Set (ls)** click **Level Set Model 1**.
- 2 In the **Settings** window for **Level Set Model**, locate the **Level Set Model** section.
- 3 In the γ text field, type 0.1 [m/s].
- 4 In the ϵ_{ls} text field, type $5e-6$.

MULTIPHYSICS

Wetted Wall 1 (ww1)

- 1 In the **Model Builder** window, under **Component 1 (comp1) > Multiphysics** click **Wetted Wall 1 (ww1)**.
- 2 Select Boundaries 2–4, 6, 7, 9, 10, and 16–20 only.
- 3 In the **Settings** window for **Wetted Wall**, locate the **Wetted Wall** section.
- 4 From the **Slip length** list, choose **User defined**. In the β text field, type $5e-6$ [m].
- 5 Locate the **Contact Angle** section. In the θ_w text field, type $3\pi/4$ [rad].

LEVEL SET (LS)

Initial Values, Fluid 2

- 1 In the **Model Builder** window, under **Component 1 (comp1) > Level Set (ls)** click **Initial Values, Fluid 2**.
- 2 Select Domain 3 only.
For Domains 1, 2 and 4, the default initial value settings apply.

LAMINAR FLOW (SPF)

In the **Model Builder** window, under **Component 1 (comp1)** click **Laminar Flow (spf)**.

Inlet 1

- 1 In the **Physics** toolbar, click  **Boundaries** and choose **Inlet**.
- 2 Select Boundary 22 only.
- 3 In the **Settings** window for **Inlet**, locate the **Boundary Condition** section.
- 4 From the list, choose **Fully developed flow**.
- 5 Locate the **Fully Developed Flow** section. Click the **Flow rate** button.
- 6 In the V_0 text field, type V1.

Inlet 2

- 1 In the **Physics** toolbar, click  **Boundaries** and choose **Inlet**.
- 2 Select Boundary 12 only.
- 3 In the **Settings** window for **Inlet**, locate the **Boundary Condition** section.
- 4 From the list, choose **Fully developed flow**.
- 5 Locate the **Fully Developed Flow** section. Click the **Flow rate** button.
- 6 In the V_0 text field, type V2.

Outlet 1

- 1 In the **Physics** toolbar, click  **Boundaries** and choose **Outlet**.
- 2 Select Boundary 1 only.

Symmetry 1

- 1 In the **Physics** toolbar, click  **Boundaries** and choose **Symmetry**.
- 2 Select Boundaries 5, 13, 14, and 21 only.

LEVEL SET (LS)

In the **Model Builder** window, under **Component 1 (comp1)** click **Level Set (ls)**.

Inlet 1

- 1 In the **Physics** toolbar, click  **Boundaries** and choose **Inlet**.
- 2 Select Boundary 12 only.
- 3 In the **Settings** window for **Inlet**, locate the **Level Set Condition** section.
- 4 From the list, choose **Fluid 2 ($\varphi = 1$)**.

Inlet 2

- 1 In the **Physics** toolbar, click  **Boundaries** and choose **Inlet**.

2 Select Boundary 22 only.

Outlet 1

1 In the **Physics** toolbar, click  **Boundaries** and choose **Outlet**.

2 Select Boundary 1 only.

Symmetry 1

1 In the **Physics** toolbar, click  **Boundaries** and choose **Symmetry**.

2 Select Boundaries 5, 13, 14, and 21 only.

MESH 1

Mapped 1

1 In the **Mesh** toolbar, click  **More Generators** and choose **Mapped**.

2 Select Boundaries 2, 7, 10, and 16 only.

Distribution 1

1 Right-click **Mapped 1** and choose **Distribution**.

2 Select Edge 3 only.

3 In the **Settings** window for **Distribution**, locate the **Distribution** section.

4 In the **Number of elements** text field, type 160.

Distribution 2

1 In the **Model Builder** window, right-click **Mapped 1** and choose **Distribution**.

2 Select Edges 1 and 9 only.

3 In the **Settings** window for **Distribution**, locate the **Distribution** section.

4 In the **Number of elements** text field, type 20.

Distribution 3

1 Right-click **Mapped 1** and choose **Distribution**.

2 Select Edges 12 and 28 only.

3 In the **Settings** window for **Distribution**, locate the **Distribution** section.

4 From the **Distribution type** list, choose **Predefined**.

5 In the **Number of elements** text field, type 25.

6 In the **Element ratio** text field, type 4.

Distribution 4

1 Right-click **Mapped 1** and choose **Distribution**.

- 2 Select Edges 24 and 27 only.
- 3 In the **Settings** window for **Distribution**, locate the **Distribution** section.
- 4 From the **Distribution type** list, choose **Predefined**.
- 5 In the **Number of elements** text field, type 20.
- 6 In the **Element ratio** text field, type 3.
- 7 Select the **Reverse direction** checkbox.

Mapped 1

Right-click **Mapped 1** and choose **Build Selected**.

Swept 1

- 1 In the **Mesh** toolbar, click  **Swept**.
- 2 In the **Settings** window for **Swept**, click to expand the **Source Faces** section.
- 3 Select Boundaries 2, 7, and 10 only.

Distribution 1

- 1 Right-click **Swept 1** and choose **Distribution**.
- 2 In the **Settings** window for **Distribution**, locate the **Distribution** section.
- 3 In the **Number of elements** text field, type 10.
- 4 Click  **Build All**.

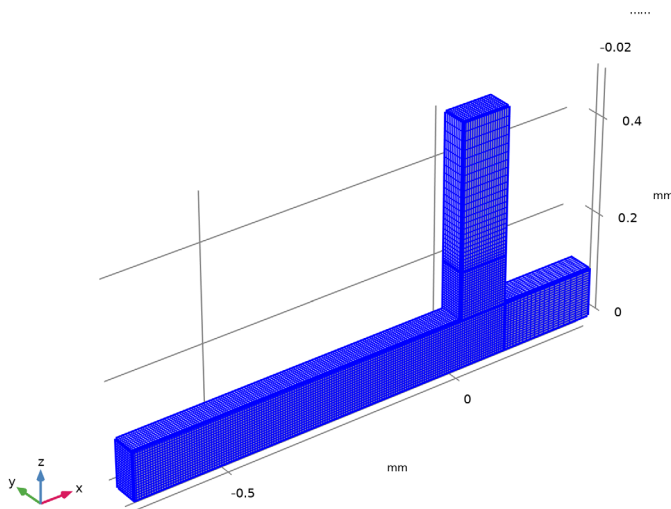



STUDY 1

Step 2: Time Dependent

- 1 In the **Model Builder** window, under **Study 1** click **Step 2: Time Dependent**.
- 2 In the **Settings** window for **Time Dependent**, locate the **Study Settings** section.
- 3 In the **Output times** text field, type range (0,2.5e-3,0.08).
- 4 Click to expand the **Results While Solving** section. Select the **Plot** checkbox.
This choice means that the **Graphics** window will show a surface plot of the volume fraction of **Fluid 1** while solving, and this plot will be updated at each output time step.

Solution 1 (sol1)

Manually tune the solver sequence for optimal performance and accuracy.

- 1 In the **Study** toolbar, click  **Show Default Solver**.
- 2 In the **Model Builder** window, expand the **Solution 1 (sol1)** node.
- 3 In the **Model Builder** window, expand the **Study 1 > Solver Configurations > Solution 1 (sol1) > Dependent Variables 2** node, then click **Velocity Field (compl.u)**.
- 4 In the **Settings** window for **Field**, locate the **Scaling** section.
- 5 From the **Method** list, choose **Manual**.
- 6 In the **Scale** text field, type 0.1.
- 7 In the **Model Builder** window, under **Study 1 > Solver Configurations > Solution 1 (sol1)** click **Time-Dependent Solver 1**.
- 8 In the **Settings** window for **Time-Dependent Solver**, click to expand the **Time Stepping** section.
- 9 Find the **Algebraic variable settings** subsection. In the **Fraction of initial step for Backward Euler** text field, type 1.
- 10 In the **Study** toolbar, click  **Compute**.

RESULTS

Isosurface 1

- 1 Right-click **Velocity (spf)** and choose **Isosurface**.
- 2 In the **Settings** window for **Isosurface**, locate the **Expression** section.
- 3 In the **Expression** text field, type $1s.Vf1$.
- 4 Locate the **Levels** section. From the **Entry method** list, choose **Levels**.
- 5 In the **Levels** text field, type 0.5.

- 6 Locate the **Coloring and Style** section. From the **Coloring** list, choose **Uniform**.
- 7 From the **Color** list, choose **Gray**.
- 8 In the **Velocity (spf)** toolbar, click  **Plot**.

Volume Fraction

- 1 In the **Model Builder** window, under **Results** click **Pressure (spf)**.
- 2 In the **Settings** window for **3D Plot Group**, locate the **Data** section.
- 3 From the **Dataset** list, choose **Study 1/Solution 1 (sol1)**.
- 4 In the **Label** text field, type Volume Fraction.

Slice 1

- 1 Right-click **Volume Fraction** and choose **Slice**.
- 2 In the **Settings** window for **Slice**, locate the **Expression** section.
- 3 In the **Expression** text field, type $1s.Vf1$.

Surface

In the **Model Builder** window, right-click **Surface** and choose **Delete**.

Volume Fraction of Fluid 1 (1s)

Now, the first default plot group shows a slice plot of the velocity combined with a contour plot of the volume fraction of fluid 1, and the second plot group shows the volume fraction of fluid 1 as a slice plot. Follow these steps to reproduce the series of velocity field plots shown in [Figure 3](#).

Slice 1

- 1 In the **Model Builder** window, expand the **Volume Fraction of Fluid 1 (1s)** node.
- 2 Right-click **Slice 1** and choose **Disable**.

Isosurface 1

- 1 In the **Model Builder** window, click **Isosurface 1**.
- 2 In the **Settings** window for **Isosurface**, locate the **Coloring and Style** section.
- 3 From the **Color** list, choose **White**.

Isosurface 2

Right-click **Results > Volume Fraction of Fluid 1 (1s) > Isosurface 1** and choose **Duplicate**.

Deformation 1

- 1 In the **Model Builder** window, right-click **Isosurface 2** and choose **Deformation**.
- 2 In the **Settings** window for **Deformation**, locate the **Expression** section.

- 3 In the **y-component** text field, type $-2*y$.
- 4 Locate the **Scale** section.
- 5 Select the **Scale factor** checkbox. In the associated text field, type 1.

Streamline 1

- 1 In the **Model Builder** window, right-click **Volume Fraction of Fluid 1 (Is)** and choose **Streamline**.
- 2 In the **Settings** window for **Streamline**, locate the **Streamline Positioning** section.
- 3 In the **Number** text field, type 8.
- 4 Select Boundaries 12 and 22 only.
- 5 Locate the **Coloring and Style** section. Find the **Line style** subsection. From the **Type** list, choose **Tube**.
- 6 Select the **Radius scale factor** checkbox. In the associated text field, type $2e-3$.

Color Expression 1

- 1 Right-click **Streamline 1** and choose **Color Expression**.
- 2 In the **Settings** window for **Color Expression**, locate the **Coloring and Style** section.
- 3 From the **Color table** list, choose **JupiterAuroraBorealis**.
- 4 Clear the **Color legend** checkbox.

Streamline 2

In the **Model Builder** window, under **Results > Volume Fraction of Fluid 1 (Is)** right-click **Streamline 1** and choose **Duplicate**.

Deformation 1

- 1 In the **Model Builder** window, right-click **Streamline 2** and choose **Deformation**.
- 2 In the **Settings** window for **Deformation**, locate the **Expression** section.
- 3 In the **y-component** text field, type $-2*y$.
- 4 Locate the **Scale** section.
- 5 Select the **Scale factor** checkbox. In the associated text field, type 1.

Surface 1

- 1 In the **Model Builder** window, right-click **Volume Fraction of Fluid 1 (Is)** and choose **Surface**.
- 2 In the **Settings** window for **Surface**, locate the **Coloring and Style** section.
- 3 From the **Coloring** list, choose **Uniform**.
- 4 From the **Color** list, choose **Gray**.

Selection 1

- 1 Right-click **Surface 1** and choose **Selection**.
- 2 Select Boundaries 3 and 17–20 only.

Surface 2

In the **Model Builder** window, under **Results > Volume Fraction of Fluid 1 (Is)** right-click **Surface 1** and choose **Duplicate**.

Deformation 1

- 1 In the **Model Builder** window, expand the **Surface 2** node.
- 2 Right-click **Surface 2** and choose **Deformation**.
- 3 In the **Settings** window for **Deformation**, locate the **Expression** section.
- 4 In the **y-component** text field, type 0.05.
- 5 Locate the **Scale** section.
- 6 Select the **Scale factor** checkbox. In the associated text field, type 1.

Selection 1

- 1 In the **Model Builder** window, click **Selection 1**.
- 2 In the **Settings** window for **Selection**, locate the **Selection** section.
- 3 Click to select the **Activate Selection** toggle button.
- 4 Select Boundaries 3–6, 9, 13, 14, and 17–21 only.

Volume Fraction of Fluid 1 (Is)

- 1 In the **Model Builder** window, under **Results** click **Volume Fraction of Fluid 1 (Is)**.
- 2 In the **Settings** window for **3D Plot Group**, locate the **Data** section.
- 3 From the **Time (s)** list, choose **0.02**.
- 4 Locate the **Plot Settings** section. Clear the **Plot dataset edges** checkbox.

5 In the **Volume Fraction of Fluid 1 (Is)** toolbar, click  **Plot**.

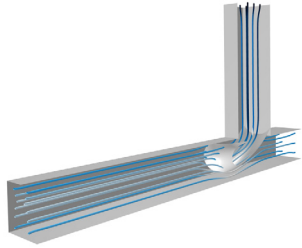

Compare the resulting plot with the upper-left plot in [Figure 3](#). To reproduce the remaining three plots, plot the solution for the time values 0.04, 0.06, and 0.08 s.

Global Evaluation 1

Next, evaluate the effective droplet diameter computed according to [Equation 1](#).



- 1 In the **Results** toolbar, click  **Global Evaluation**.
- 2 In the **Settings** window for **Global Evaluation**, click **Replace Expression** in the upper-right corner of the **Expressions** section. From the menu, choose **Component 1 (comp1) > Definitions > Variables > d_eff - Effective droplet diameter - m**.
- 3 Click  **Evaluate**.

TABLE 1

- 1 Go to the **Table 1** window.

The result, roughly 0.12 mm, is displayed in the table in the **Table** window.

RESULTS

Finally, generate a movie of the moving fluid interface and the velocity streamlines.

Volume Fraction of Fluid 1 (Is)

In the **Model Builder** window, under **Results** click **Volume Fraction of Fluid 1 (Is)**.

Animation 1

- 1 In the **Volume Fraction of Fluid 1 (Is)** toolbar, click  **Animation** and choose **Player**.
COMSOL Multiphysics generates the movie. To play the movie, click the **Play** button in the **Graphics** toolbar. If you want to export a movie in GIF, Flash, or AVI format, select **File** from the **Target** list.

