



Model created in COMSOL Multiphysics 6.4

# Thermal Runaway Propagation in a Battery Pack

## *Introduction*

---

Due to abuse, such as internal or external short circuits or excessive heating, an individual battery cell may go into thermal runaway, during which the battery cell generates a significant amount of heat. If enough heat is transferred between adjacent cells during a thermal runaway event, neighboring cells will also go into thermal runaway.

A thermal runaway propagating through the whole pack constitutes a severe safety hazard. When designing a battery pack, measures need to be taken in order to mitigate runaway propagation.

This tutorial simulates the heat transfer and resulting thermal runaway propagation in a pack consisting of 20 cylindrical cells using event-based heat sources.

For a general introduction to the battery pack interface, the user is also referred to the tutorial [Thermal Distribution in a Pack of Cylindrical Batteries](#).

## *Model Definition*

---

[Figure 1](#) shows the model geometry. The pack consists of 20 cylindrical batteries in a 5s4p configuration. In a 5s4p configuration, 4 sets of battery cells are connected in parallel, and each set contains 5 serially connected individual battery cells. Two plastic holder frames are used for fixating the battery locations and cell-to-cell distances. Serial connectors are welded to the battery terminals, and parallel connectors are in turn welded to the serial connectors, midway between the battery cylinders. A thin plastic wrapping encloses the whole pack, thereby forming a compartment of quiescent air surrounding the battery cylinders.

The following materials are used from the built-in material library:

- Plastic holders: Acrylic Plastic
- Connectors and battery terminals: Steel AISI 4340
- Air compartment: Air

The battery pack model is set up in a similar manner as in the [Thermal Distribution in a Pack of Cylindrical Batteries](#) tutorial, using the **Battery Pack** interface together with a **Heat Transfer** interface and an **Electrochemical Heating** multiphysics node. The **Battery Layers** node in heat transfer is used to define the anisotropic properties of the battery cylinders.

The pack is charged from an initial state of charge of 25% at a 2C rate. The **Charge–Discharge Cycling** node is used to control the load current so that it is turned off when the

pack voltage exceeds 21 V. The initial pack temperature is set to equal the surrounding temperature of 30°C.

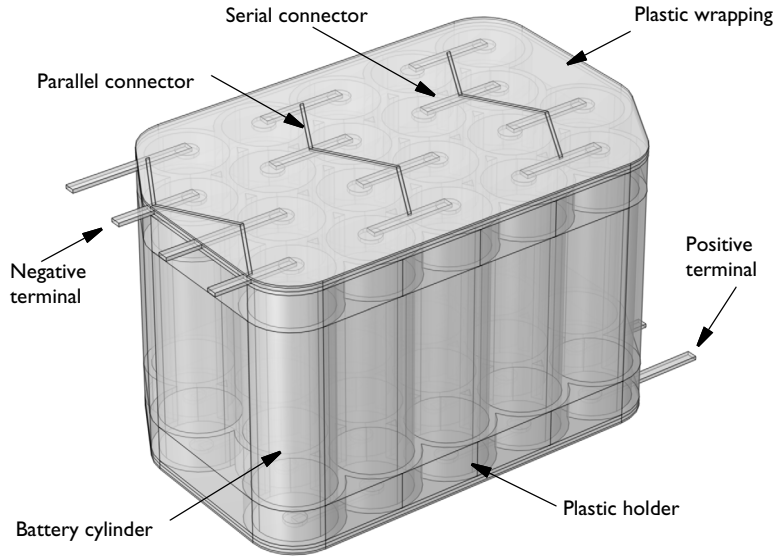

*Figure 1: Model geometry.*

The cell thermal runaway is modeled by the use of **Thermal Event** nodes in the battery pack interface. At the triggering of a thermal event in a battery cylinder, a time-dependent heat source is released as shown in [Figure 2](#) with a total released heat equal to 22 kJ. The heat profile was taken from [Ref. 1](#). Due to the loss of electrolyte and the resulting increase of the internal battery resistances, the ohmic resistance of the corresponding battery model in each cylinder is increased about two orders of magnitude when a thermal event is triggered.

To initiate the propagation of the thermal runaway, one cell is assumed to start malfunctioning at an early stage in the charge cycle (due to an internal short circuit, or similar). The triggering of the malfunctioning cell is set explicitly to begin at  $t = 1$  min into the simulation. For the remaining cells, the thermal events are set to be triggered when the maximum temperature of an individual cell exceeds 80°C.

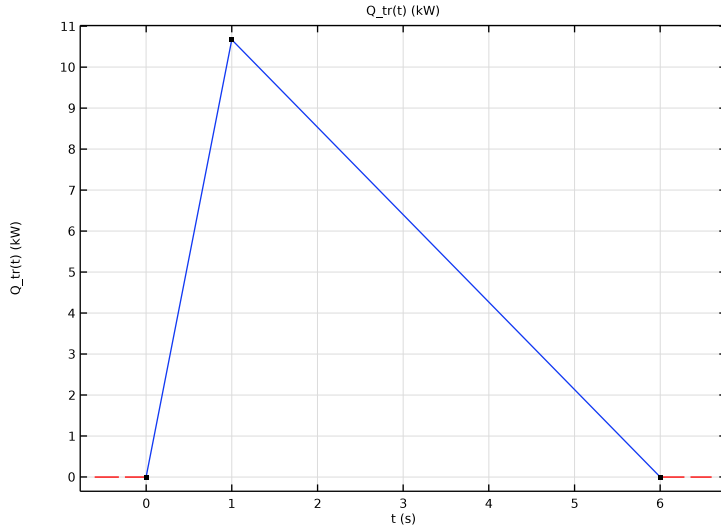

Figure 2: Heat source released in an individual battery cell when a thermal event is triggered.

## Results and Discussion

Figure 3 shows the pack voltage and maximum battery temperature in the pack versus time. The steep gradients in the temperature curve indicate the triggering of the thermal events. At the triggering of each event, a small shift in the pack voltage curve can also be seen, which is related to the corresponding increase in cell resistance, impacting the current distribution in the pack.

During the first minute, only a small temperature increase can be observed. This is due to Joule heating and other processes during normal charging operation. After triggering of the first cell runaway at 1 min, there is a steep increase in the maximum temperature, after which there is an incubation time of several minutes until enough heat has spread to a neighboring cell in order to trigger consecutive runaways. After triggering of this second runaway, the intervals between successive cell runaways become shorter.

After about 10 min, the maximum charging voltage limit has been reached, and the charging of the pack is turned off. However, the thermal runaway continues to propagate through the pack also after this.

A few minutes later, all cells have gone through thermal runaway, and the maximum temperature slowly starts to relax toward the surrounding temperature of 30°C.

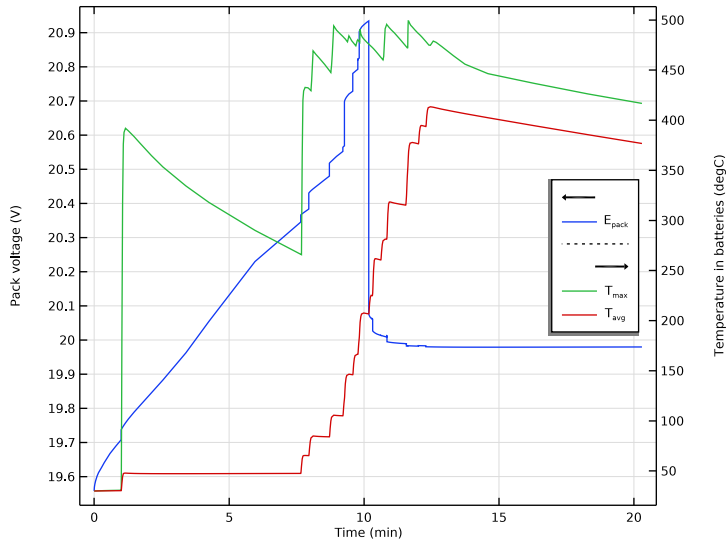

Figure 3: Pack voltage and maximum battery temperature in the pack.

The temperature in the pack, excluding the air domain, at various times is shown in Figure 4.

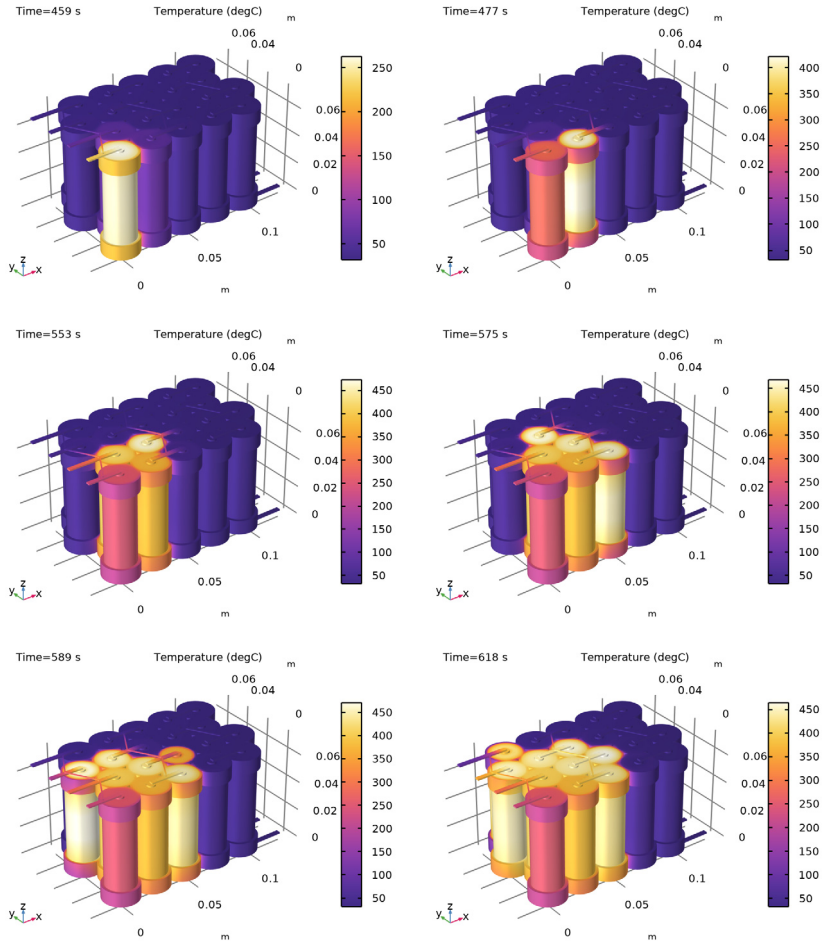

Figure 4: Temperature surface plots at various times.

### Reference

1. P.T. Coman, E.C. Darcy, and R.E. White, "Simplified Thermal Runaway Model for Assisting the Design of a Novel Safe Li-Ion Battery Pack," *J. Electrochem. Soc.*, vol. 169, p. 040516, 2022.

---

**Application Library path:** Battery\_Design\_Module/Thermal\_Management/  
thermal\_runaway\_propagation

---

### *Modeling Instructions*



---

From the **File** menu, choose **New**.

#### **NEW**



In the **New** window, click  **Model Wizard**.

#### **MODEL WIZARD**

- 1 In the **Model Wizard** window, click  **3D**.
- 2 In the **Select Physics** tree, select **Electrochemistry** > **Batteries** > **Battery Pack (bp)**.
- 3 Click **Add**.
- 4 In the **Select Physics** tree, select **Heat Transfer** > **Heat Transfer in Solids (ht)**.
- 5 Click **Add**.
- 6 Click  **Study**.
- 7 In the **Select Study** tree, select **General Studies** > **Time Dependent**.
- 8 Click  **Done**.

#### **GEOMETRY I**

Import the geometry sequence from a file.

- 1 In the **Geometry** toolbar, click **Insert Sequence** and choose **Insert Sequence**.
- 2 Browse to the model's Application Libraries folder and double-click the file `thermal_runaway_propagation_geom_sequence.mph`.
- 3 In the **Insert Sequence** dialog, select **Geometry I** in the **Select geometry sequence to insert** list.
- 4 Click **OK**.
- 5 In the **Geometry** toolbar, click  **Build All**.  
Inspect the imported geometry. You can enable and disable wireframe rendering and transparency to view internal geometry features.
- 6 Click the  **Transparency** button in the **Graphics** toolbar.

**7** In the **Model Builder** window, under **Component 1 (comp1)** click **Geometry 1**.



Disable the analysis of the geometry as the remaining small geometric details can be kept.

**8** In the **Model Builder** window, click **Geometry 1**.

**9** In the **Settings** window for **Geometry**, locate the **Cleanup** section.

**10** Clear the **Automatic detection of small details** checkbox.

## **GEOMETRY 1**

In the **Model Builder** window, collapse the **Component 1 (comp1) > Geometry 1** node.

## **GLOBAL DEFINITIONS**

### *Geometry Parameters*



Some geometry parameters were imported together with the geometry sequence.

**1** In the **Model Builder** window, under **Global Definitions** click **Parameters 1**.



**2** In the **Settings** window for **Parameters**, type Geometry Parameters in the **Label** text field.

### *Physics Parameters*

Import some additional parameters needed for setting up the physics.

- 1 In the **Home** toolbar, click  **Parameters** and choose **Add > Parameters**.
- 2 In the **Settings** window for **Parameters**, type **Physics Parameters** in the **Label** text field.
- 3 Locate the **Parameters** section. Click  **Load from File**.
- 4 Browse to the model's Application Libraries folder and double-click the file `thermal_runaway_propagation_physics_parameters.txt`.

#### ADD MATERIAL

- 1 In the **Home** toolbar, click  **Add Material** to open the **Add Material** window.
- 2 Go to the **Add Material** window.  
Add some materials from the built-in material library.
- 3 In the tree, select **Built-in > Air**.
- 4 Right-click and choose **Add to Component 1 (comp1)**.
- 5 In the tree, select **Built-in > Acrylic plastic**.
- 6 Right-click and choose **Add to Component 1 (comp1)**.
- 7 In the tree, select **Built-in > Steel AISI 4340**.
- 8 Right-click and choose **Add to Component 1 (comp1)**.
- 9 In the **Home** toolbar, click  **Add Material** to close the **Add Material** window.

#### MATERIALS

##### *Air (mat1)*

- 1 In the **Settings** window for **Material**, locate the **Geometric Entity Selection** section.
- 2 From the **Selection** list, choose **Air Compartment**.

##### *Acrylic plastic (mat2)*

- 1 In the **Model Builder** window, click **Acrylic plastic (mat2)**.
- 2 In the **Settings** window for **Material**, locate the **Geometric Entity Selection** section.
- 3 From the **Selection** list, choose **Holders (Part 3 - Holders 1)**.

##### *Steel AISI 4340 (mat3)*

- 1 In the **Model Builder** window, click **Steel AISI 4340 (mat3)**.
- 2 In the **Settings** window for **Material**, locate the **Geometric Entity Selection** section.
- 3 From the **Selection** list, choose **All Conductors (Part 2 - Conductors 1)**.

## BATTERY PACK (BP)



The battery pack interface is active on the battery and conductor domains only.

- 1 In the **Model Builder** window, under **Component 1 (comp1)** click **Battery Pack (bp)**.
- 2 In the **Settings** window for **Battery Pack**, locate the **Domain Selection** section.
- 3 From the **Selection** list, choose **Batteries and Conductors**.

### *Batteries*

- 1 In the **Model Builder** window, under **Component 1 (comp1)** > **Battery Pack (bp)** click **Batteries**.
- 2 In the **Settings** window for **Batteries**, locate the **Domain Selection** section.
- 3 From the **Selection** list, choose **Batteries**.
- 4 Locate the **Initial Capacity** section. In the  $Q_{\text{cell},0}$  text field, type  $Q_{\text{cell}}$ .
- 5 Locate the **Initial Cell Charge Distribution** section. In the  $\text{SOC}_{\text{cell},0}$  text field, type  $\text{SOC}_0$ .

### *Cell Equilibrium Potential 1*

- 1 In the **Model Builder** window, click **Cell Equilibrium Potential 1**.
- 2 In the **Settings** window for **Cell Equilibrium Potential**, locate the **Open Circuit Voltage** section.
- 3 Click  **Clear Table**.
- 4 Click  **Load from File**.
- 5 Browse to the model's Application Libraries folder and double-click the file `thermal_runaway_propagation_E_OCP_data.txt`.

In this tutorial we will keep the default value of 0 for the temperature derivative of the open circuit voltage for all SOC values. The reason is that during the thermal runaway, very high temperatures are expected, which in turn would result in inaccurate cell open circuit voltage values for nonzero values of the derivative.

### *Voltage Losses 1*



- 1 In the **Model Builder** window, click **Voltage Losses 1**.
- 2 In the **Settings** window for **Voltage Losses**, locate the **Ohmic Overpotential** section.
- 3 In the  $\eta_{\text{IR},1\text{C}}$  text field, type  $\text{eta}_{1\text{C}}$ .
- 4 Locate the **Activation Overpotential** section. In the  $J_0$  text field, type  $J_0$ .
- 5 Locate the **Concentration Overpotential** section. Select the **Include concentration overpotential** checkbox.
- 6 In the  $\tau$  text field, type  $\text{tau}$ .

### Batteries

This model will make use of two thermal events. The first event triggers a heat source in a malfunctioning cell at an explicit time.

- 1 In the **Model Builder** window, click **Batteries**.

### Thermal Event 1

- 1 In the **Physics** toolbar, click  **Attributes** and choose **Thermal Event**.
- 2 In the **Settings** window for **Thermal Event**, locate the **Domain Selection** section.
- 3 Click  **Clear Selection**.
- 4 Select Domains 24–26 only.
- 5 Locate the **Thermal Event** section. From the **Event condition** list, choose **Explicit time**.
- 6 In the  $t_{\text{exp}}$  text field, type  $t_{\text{start}}$ .
- 7 In the table, enter the following settings:

Time after event (s)	Heat source (W)
$t_{\text{peak}}$	$Qh_{\text{peak}}$

- 8 Click  **Add**.
- 9 In the table, enter the following settings:

Time after event (s)	Heat source (W)
$t_{\text{tr}}$	0

- 10 Select the **Add ohmic overpotential after event** checkbox.
- 11 Locate the **Domain Selection** section. Click  **Create Selection**.  
Create a named selection of the malfunctioning cell. This will make it easy to select the complementary (nonmalfunctioning) battery cells.
- 12 In the **Create Selection** dialog, type Malfunctioning Cell in the **Selection name** text field.
- 13 Click **OK**.

### DEFINITIONS (COMP1)

In the **Model Builder** window, expand the **Component 1 (comp1) > Definitions** node.

### Nonmalfunctioning Cells

- 1 In the **Model Builder** window, expand the **Component 1 (comp1) > Definitions > Selections** node.

- 2 Right-click **Component 1 (comp1)** > **Definitions** and choose **Selections** > **Difference**.
- 3 In the **Settings** window for **Difference**, type Nonmalfunctioning Cells in the **Label** text field.
- 4 Locate the **Input Entities** section. Under **Selections to add**, click **+ Add**.
- 5 In the **Add** dialog, select **Batteries** in the **Selections to add** list.
- 6 Click **OK**.
- 7 In the **Settings** window for **Difference**, locate the **Input Entities** section.
- 8 Under **Selections to subtract**, click **+ Add**.
- 9 In the **Add** dialog, select **Malfunctioning Cell** in the **Selections to subtract** list.
- 10 Click **OK**.

## **BATTERY PACK (BP)**

### *Thermal Event 1*

Now duplicate the first thermal event to create a second one for the complementary cells that is to be triggered if the maximum temperature exceeds a certain trigger level.

### *Thermal Event 2*

- 1 In the **Model Builder** window, under **Component 1 (comp1)** > **Battery Pack (bp)** > **Batteries** right-click **Thermal Event 1** and choose **Duplicate**.
- 2 In the **Settings** window for **Thermal Event**, locate the **Domain Selection** section.
- 3 From the **Selection** list, choose **Nonmalfunctioning Cells**.
- 4 Locate the **Thermal Event** section. From the **Event condition** list, choose **Maximum temperature**.
- 5 In the  $T_{\max,te}$  text field, type  $T_{\text{trigger}}$ .

### *Current Conductors*

Ground the negative terminals of the pack as follows:

- 1 In the **Model Builder** window, under **Component 1 (comp1)** > **Battery Pack (bp)** click **Current Conductors**.
- 2 In the **Settings** window for **Current Conductors**, locate the **Domain Selection** section.
- 3 From the **Selection** list, choose **All Conductors (Part 2 - Conductors 1)**.

### *Ground 1*

- 1 In the **Physics** toolbar, click  **Attributes** and choose **Ground**.
- 2 In the **Settings** window for **Ground**, locate the **Boundary Selection** section.

- 3 From the **Selection** list, choose **Conductor Boundaries, Negative Terminals (Part 2 - Conductors I)**.

#### *Current Conductors*

Use a charge-discharge cycling condition on the positive terminals of the pack. This will turn off the charging current when a specified voltage maximum level is reached.

- 1 In the **Model Builder** window, click **Current Conductors**.

#### *Charge-Discharge Cycling I*

- 1 In the **Physics** toolbar, click  **Attributes** and choose **Charge-Discharge Cycling**.
- 2 In the **Settings** window for **Charge-Discharge Cycling**, locate the **Boundary Selection** section.
- 3 From the **Selection** list, choose **Conductor Boundaries, Positive Terminals (Part 2 - Conductors I)**.
- 4 Locate the **Charge Settings** section. In the  $I_{ch}$  text field, type  $C\_rate * I_{1C\_pack}$ .
- 5 In the  $V_{max}$  text field, type  $E\_max\_pack$ .
- 6 Select the **Include rest period** checkbox.
- 7 In the  $t_{rest,ch}$  text field, type  $1 [h]$ .
- 8 Locate the **Start Mode** section. From the **Start with** list, choose **Charge first**.

#### *Negative Connectors*

Finalize the pack part of the model by specifying how the batteries are connected to the conductor domains.

- 1 In the **Model Builder** window, under **Component 1 (comp1) > Battery Pack (bp)** click **Negative Connectors**.
- 2 In the **Settings** window for **Negative Connectors**, locate the **Boundary Selection** section.
- 3 From the **Selection** list, choose **Negative Connectors**.

#### *Positive Connectors*

- 1 In the **Model Builder** window, click **Positive Connectors**.
- 2 In the **Settings** window for **Positive Connectors**, locate the **Boundary Selection** section.
- 3 From the **Selection** list, choose **Positive Connectors**.

## **HEAT TRANSFER IN SOLIDS (HT)**

Now setup the heat transfer part of the model. Start with specifying the properties of the layers (jelly roll) of the active battery materials.

- 1 In the **Model Builder** window, under **Component 1 (comp1)** click **Heat Transfer in Solids (ht)**.

#### *Battery Layers 1*

- 1 In the **Physics** toolbar, click  **Domains** and choose **Battery Layers**.
- 2 In the **Settings** window for **Battery Layers**, locate the **Domain Selection** section.
- 3 From the **Selection** list, choose **Batteries**.
- 4 Locate the **Battery Layers** section. From the **Layer configuration** list, choose **Spirally wound (cylindrical)**.
- 5 In the  $k_{t1}$  text field, type `kT_batt_t1`.
- 6 In the  $k_{i1}$  text field, type `kT_batt_i1`.
- 7 In the  $\rho_{\text{eff}}$  text field, type `rho_batt`.
- 8 In the  $C_{p,\text{eff}}$  text field, type `Cp_batt`.

#### *Initial Values 1*

- 1 In the **Model Builder** window, click **Initial Values 1**.
- 2 In the **Settings** window for **Initial Values**, locate the **Initial Values** section.
- 3 In the  $T$  text field, type `T_ext`.

#### *Heat Flux 1*

- 1 In the **Physics** toolbar, click  **Boundaries** and choose **Heat Flux**.
- 2 In the **Settings** window for **Heat Flux**, locate the **Boundary Selection** section.
- 3 From the **Selection** list, choose **All boundaries**.
- 4 Locate the **Heat Flux** section. From the **Flux type** list, choose **Convective heat flux**.
- 5 In the  $h$  text field, type `h_conv`.
- 6 In the  $T_{\text{ext}}$  text field, type `T_ext`.

### **MULTIPHYSICS**

#### *Electrochemical Heating 1 (ech1)*

In the **Physics** toolbar, click  **Multiphysics Couplings** and choose **Domain > Electrochemical Heating**.

### **MESH 1**

For this model we will create a swept mesh in the longitudinal axis direction of the battery cylinders.

### *Identical Mesh 1*

- 1 In the **Mesh** toolbar, click  **More Attributes** and choose **Identical Mesh**.
- 2 In the **Settings** window for **Identical Mesh**, locate the **First Entity Group** section.
- 3 From the **Selection** list, choose **Identical Mesh Boundaries, Group 1**.
- 4 Locate the **Second Entity Group** section. From the **Selection** list, choose **Identical Mesh Boundaries, Group 2**.

### *Free Triangular 1*

- 1 In the **Mesh** toolbar, click  **More Generators** and choose **Free Triangular**.
- 2 In the **Settings** window for **Free Triangular**, locate the **Boundary Selection** section.
- 3 From the **Selection** list, choose **Identical Mesh Boundaries, Group 1**.

### *Size 1*

- 1 Right-click **Free Triangular 1** and choose **Size**.
- 2 In the **Settings** window for **Size**, locate the **Element Size** section.
- 3 Click the **Custom** button.
- 4 Locate the **Element Size Parameters** section.
- 5 Select the **Minimum element size** checkbox. In the associated text field, type  $gap/2$ .
- 6 Select the **Resolution of narrow regions** checkbox. In the associated text field, type 1.5.

### *Size*

- 1 In the **Model Builder** window, under **Component 1 (comp1) > Mesh 1** click **Size**.
- 2 In the **Settings** window for **Size**, locate the **Element Size** section.
- 3 From the **Predefined** list, choose **Coarse**.

4 Click  **Build All**.

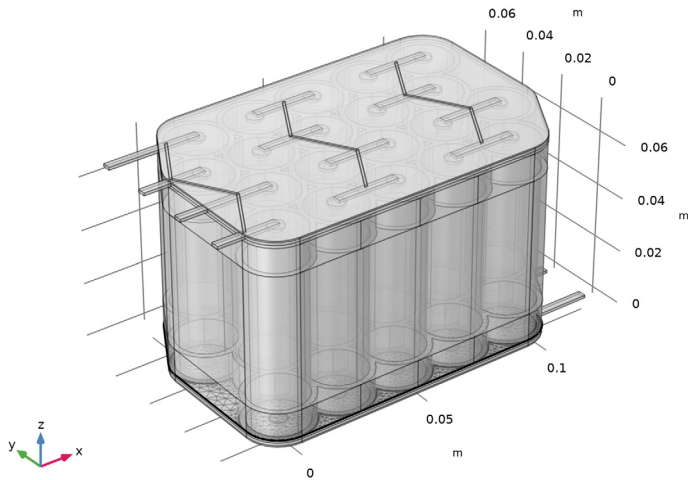

### *Swept 1*

- 1 In the **Mesh** toolbar, click  **Swept**.
- 2 In the **Settings** window for **Swept**, locate the **Domain Selection** section.
- 3 From the **Geometric entity level** list, choose **Domain**.
- 4 From the **Selection** list, choose **Mesh Sweep Domains**.

5 Click  **Build Selected.**

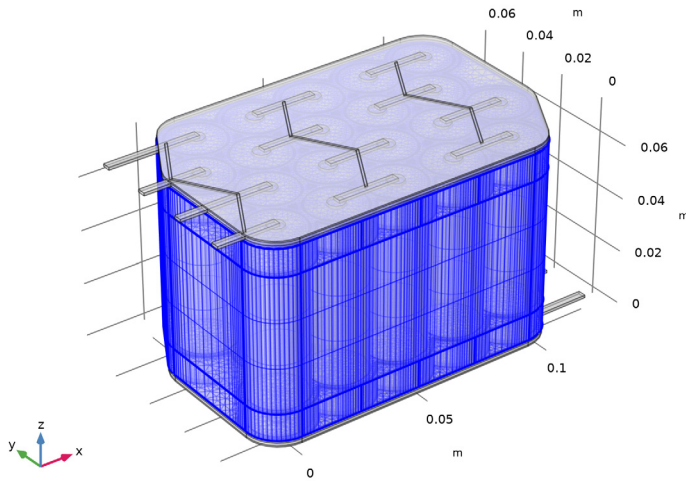

*Free Tetrahedral 1*

1 In the **Mesh** toolbar, click  **Free Tetrahedral.**

2 In the **Settings** window for **Free Tetrahedral**, click  **Build All.**

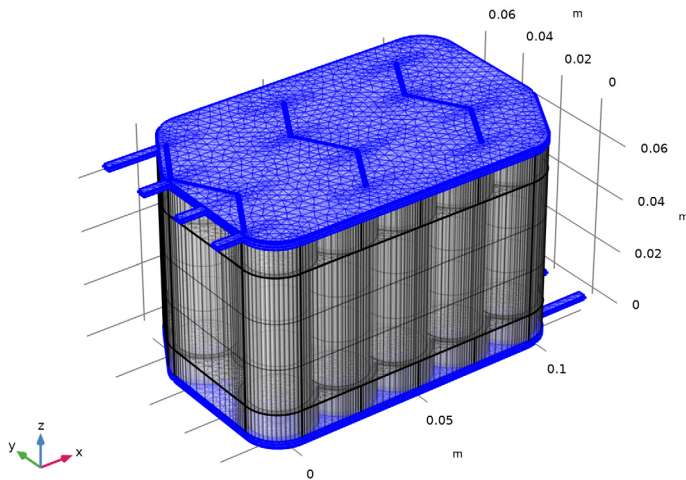

## DEFINITIONS (COMPI)

Add probes for the pack voltage and the maximum and average battery temperatures before solving. The probes will output their corresponding values to a table for each step taken by the time-dependent solver.

### *Global Variable Probe 1 (var1)*

- 1 In the **Definitions** toolbar, click  **Probes** and choose **Global Variable Probe**.
- 2 In the **Settings** window for **Global Variable Probe**, click **Replace Expression** in the upper-right corner of the **Expression** section. From the menu, choose **Component 1 (comp1) > Battery Pack > Charge-Discharge Cycling 1 > bp.ccnd.cdcl.phis0 - Cell potential - V**.
- 3 Locate the **Expression** section.
- 4 Select the **Description** checkbox. In the associated text field, type Pack voltage.
- 5 Click to expand the **Table and Window Settings** section. Click **+ Add Table**.
- 6 Click **+ Add Plot Window**.

### *Domain Probe 1 (dom1)*

- 1 In the **Definitions** toolbar, click  **Probes** and choose **Domain Probe**.
- 2 In the **Settings** window for **Domain Probe**, locate the **Probe Type** section.
- 3 From the **Type** list, choose **Maximum**.
- 4 Locate the **Source Selection** section. From the **Selection** list, choose **Batteries**.
- 5 Click **Replace Expression** in the upper-right corner of the **Expression** section. From the menu, choose **Component 1 (comp1) > Heat Transfer in Solids > Temperature > T - Temperature - K**.
- 6 Locate the **Expression** section. In the **Table and plot unit** field, type degC.
- 7 Select the **Description** checkbox. In the associated text field, type Maximum temperature in batteries.
- 8 Click to expand the **Table and Window Settings** section. Click **+ Add Table**.
- 9 From the **Plot window** list, choose **Probe Plot 1**.

### *Domain Probe 2 (dom2)*

- 1 In the **Model Builder** window, right-click **Domain Probe 1 (dom1)** and choose **Duplicate**.
- 2 In the **Settings** window for **Domain Probe**, locate the **Probe Type** section.
- 3 From the **Type** list, choose **Average**.
- 4 Locate the **Expression** section. In the **Description** text field, type Average temperature in batteries.



## STUDY I

### *Step 1: Time Dependent*

- 1 In the **Model Builder** window, under **Study I** click **Step 1: Time Dependent**.
- 2 In the **Settings** window for **Time Dependent**, locate the **Study Settings** section.
- 3 From the **Time unit** list, choose **min**.
- 4 In the **Output times** text field, type range (0,5,20).

### *Solution 1 (sol1)*

In order to improve the accuracy of the solution, set the initial step of the time-dependent solver to 0.1 s. This will ensure that the heat released by each thermal event is properly resolved in the time domain.

- 1 In the **Study** toolbar, click  **Show Default Solver**.
- 2 In the **Model Builder** window, expand the **Solution 1 (sol1)** node, then click **Time-Dependent Solver 1**.
- 3 In the **Settings** window for **Time-Dependent Solver**, click to expand the **Time Stepping** section.
- 4 In the **Initial step** text field, type 0.1 [s].
- 5 Click to expand the **Output** section. Also disable storing of the time-derivatives. This will avoid numerical artifacts when interpolating between solutions at different times when creating an animation of the runaway propagation. It will also reduce the required disk space for storing the model.
- 6 Clear the **Store the first time derivative** checkbox.
- 7 In the **Study** toolbar, click  **Compute**.

## RESULTS

### *Temperature (ht)*

Modify the default temperature plot as follows:

- 1 In the **Model Builder** window, under **Results** click **Temperature (ht)**.
- 2 In the **Settings** window for **3D Plot Group**, locate the **Plot Settings** section.
- 3 Clear the **Plot dataset edges** checkbox.

### *Volume 1*

- 1 In the **Model Builder** window, expand the **Temperature (ht)** node.
- 2 Right-click **Volume 1** and choose **Delete**.



### Temperature (ht)

- 1 In the **Settings** window for **3D Plot Group**, click to expand the **Selection** section.
- 2 From the **Geometric entity level** list, choose **Boundary**.
- 3 From the **Selection** list, choose **Non-Air External Boundaries**.

### Surface 1

- 1 Right-click **Temperature (ht)** and choose **Surface**.
- 2 In the **Settings** window for **Surface**, locate the **Expression** section.
- 3 In the **Expression** text field, type T.
- 4 In the **Unit** field, type degC.
- 5 Locate the **Coloring and Style** section. From the **Color table** list, choose **HeatCameraLight**.
- 6 In the **Temperature (ht)** toolbar, click  **Plot**.

### Temperature (ht)

- 1 In the **Model Builder** window, click **Temperature (ht)**.
- 2 In the **Settings** window for **3D Plot Group**, click to expand the **Title** section.
- 3 From the **Title type** list, choose **Manual**.
- 4 In the **Parameter indicator** text field, type `Time=eval(round(t)) s`.
- 5 Click the  **Transparency** button in the **Graphics** toolbar.
- 6 In the **Temperature (ht)** toolbar, click  **Plot**.

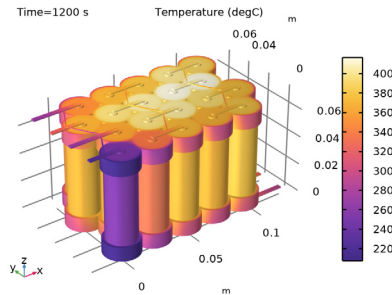

You may now change the time in the **Data** section to plot the temperature at various times. By default the solver is set to output the solution before and after triggering of an event hence the dual entries for some of the times in the list.

- 7 Locate the **Data** section. From the **Time (min)** list, choose **7.6551**.

8 In the **Temperature (ht)** toolbar, click  **Plot**.

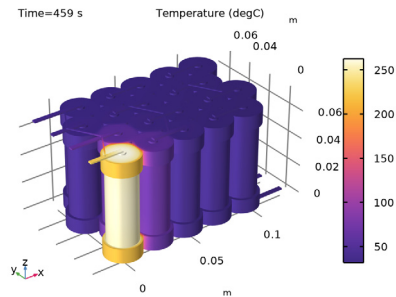

### *Pack Voltage and Max Temperature Probes*

Polish the default-generated probe plot as follows:

- 1 In the **Model Builder** window, under **Results** click **Probe Plot Group 1**.
- 2 In the **Settings** window for **ID Plot Group**, type Pack Voltage and Max Temperature Probes in the **Label** text field.
- 3 Locate the **Plot Settings** section. Select the **Two y-axes** checkbox.
- 4 In the table, select the **Plot on secondary y-axis** checkbox for **Probe Table Graph 2**.
- 5 Select the **Secondary y-axis label** checkbox. In the associated text field, type Temperature in batteries (degC).
- 6 Locate the **Legend** section. From the **Position** list, choose **Middle right**.

### *Probe Table Graph 1*

- 1 In the **Model Builder** window, expand the **Pack Voltage and Max Temperature Probes** node, then click **Probe Table Graph 1**.
- 2 In the **Settings** window for **Table Graph**, click to expand the **Legends** section.
- 3 From the **Legends** list, choose **Manual**.
- 4 In the table, enter the following settings:

---

**Legends**

---

E<sub>pack</sub>

---

### *Probe Table Graph 2*

- 1 In the **Model Builder** window, click **Probe Table Graph 2**.
- 2 In the **Settings** window for **Table Graph**, locate the **Legends** section.
- 3 From the **Legends** list, choose **Manual**.

4 In the table, enter the following settings:

---

**Legends**

$T_{\text{max}}$

$T_{\text{avg}}$

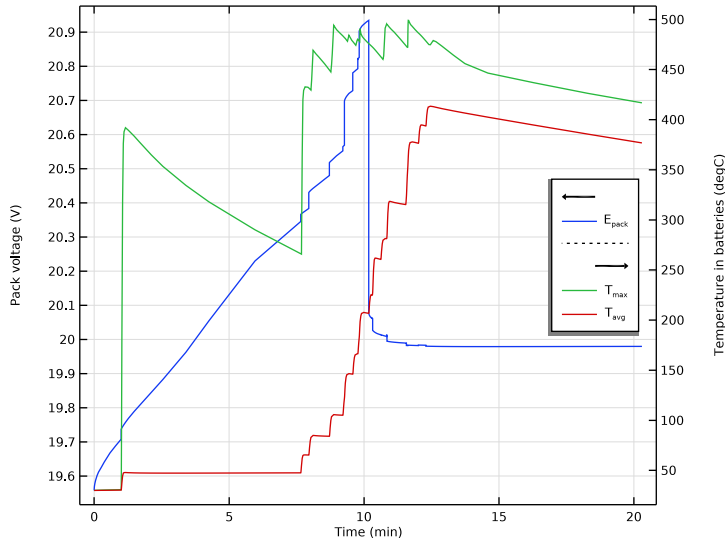

---

5 In the **Pack Voltage and Max Temperature Probes** toolbar, click  **Plot**.



*Animation 1*

You may also create an animation of the temperature surface plot as follows:

- 1 In the **Results** toolbar, click  **Animation** and choose **Player**.
- 2 In the **Settings** window for **Animation**, locate the **Scene** section.
- 3 From the **Subject** list, choose **Temperature (ht)**.
- 4 Locate the **Animation Editing** section. From the **Time selection** list, choose **Interpolated**.
- 5 In the **Times (min)** text field, type range (0, 0.25, 20).
- 6 Locate the **Frames** section. From the **Frame selection** list, choose **All**.
- 7 Click the  **Play** button in the **Graphics** toolbar.