



Model created in COMSOL Multiphysics 6.4

# Battery Overdischarge Protection Using Shunt Resistances

## *Introduction*

---

When integrating battery cells into packs, additional circuit components may be added for handling cell-to-cell balancing and overcharge/discharge protection. This tutorial demonstrates how to investigate the dynamics of battery cells when integrated with electronics.

The tutorial defines a small circuit of two lithium-ion batteries connected in series (2s configuration). After some time of operation, one of the batteries is assumed to start discharging at a higher rate due to a small internal short circuit, resulting in an uneven discharge/balance of the batteries, and, in the end, over discharge. To mitigate the risk of over discharge, the electrical circuit is then modified by introducing additional shunt resistances coupled in parallel to the batteries, and switching logic.

## *Model Definition*

---

The model is set up in 0D. The Electrical Circuit interface is used to define the circuit, consisting of a current source, a resistive load and the two shunt resistances. The batteries are connected to the electrical circuit by using External I Versus U nodes.

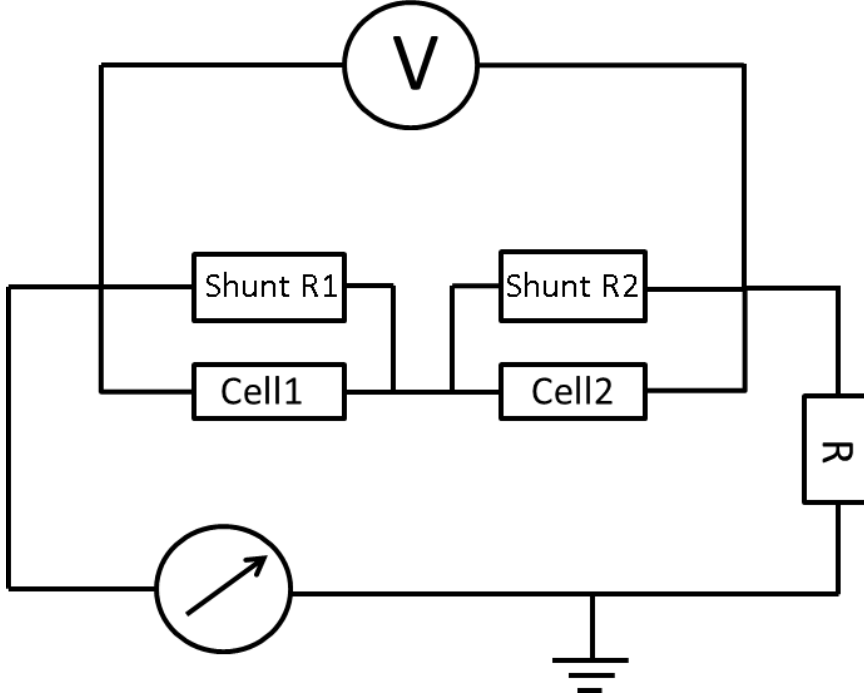

Figure 1: Circuit diagram used in the overdischarge protection circuit.

The battery cells are defined using the Lumped Battery Interface (one instance per battery cell), using the Circuit Voltage Source operation mode. The two lumped battery models are identical apart from a Short Circuit node added to Cell 1. The short circuiting of Cell 1 starts after 50 s.

The switching logic for the shunt resistances is set up using the Events interface.

Table 1 lists the values of the event-based shunt resistances used in the model.

TABLE 1: VALUE OF SHUNT RESISTANCES BASED ON THE SOC LEVELS.

Variable	Value	Indicator state to fire shunt
Shunt_R1	$10^8$ ohm	SOC for Cell1 > 0.2
Shunt_R1	$2.22 \cdot 10^{-8}$ ohm	SOC for Cell1 $\leq$ 0.2
Shunt_R2	$10^8$ ohm	SOC for Cell2 > 0.2
Shunt_R2	$2.22 \cdot 10^{-8}$ ohm	SOC for Cell2 $\leq$ 0.2

The two different variants of the model is simulated. In Study 1 the model is solved without the event-triggered shunts, whereas in Study 2 the shunts are active.

## Results and Discussion

Figure 2 shows the cell voltages for the different batteries in operation and of the voltmeter across the series connection for Study 1 (without shunts) and Study 2 (with shunts). The dashed lines show sharp dips in the respective voltages for the individual cells when the events monitoring the SOC levels are triggered, and the cells begin to discharge through the respective shunt resistors coupled in parallel to the batteries.

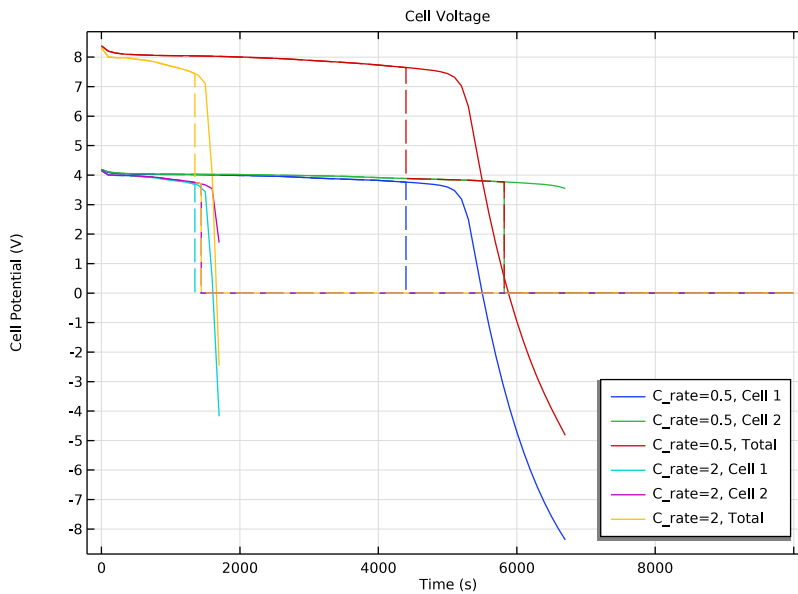

Figure 2: Cell voltages for lumped batteries and the measurement across the voltmeter. Solid lines represent the case when not using shunts, and the dashed lines the case using active shunts.

Figure 3 shows the corresponding cell currents for the two batteries. The magnitude of the current drawn from each cell at the moment the shunts are triggered depends on the C-rate.

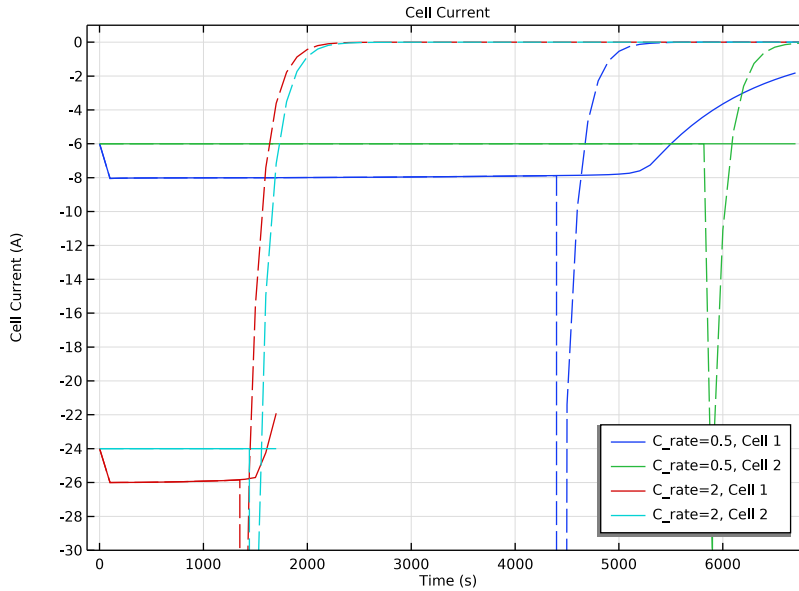

Figure 3: Cell current of the two batteries at different C-rates. Solid lines represent the case when not using shunts, and the dashed lines the case using active shunts.

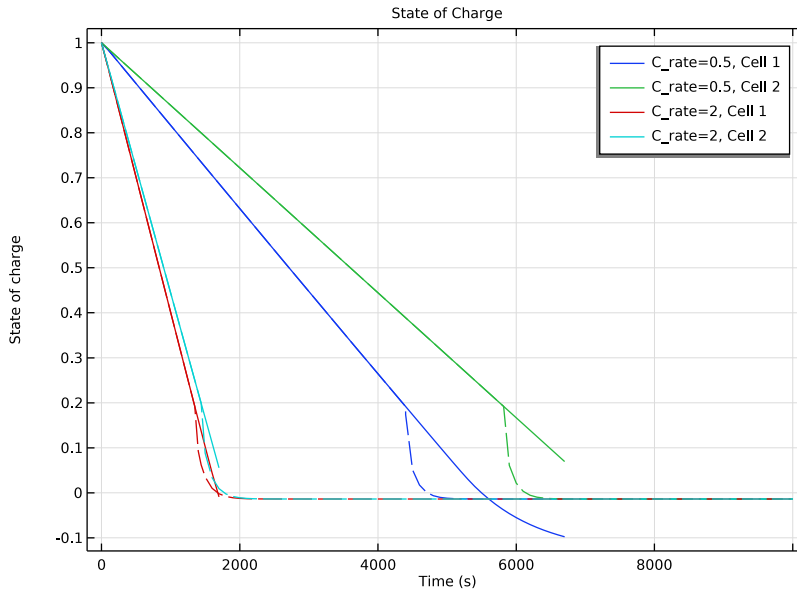

Figure 4: State-of-charge for the batteries at different C-rates. Solid lines represent the case when not using shunts, and the dashed lines the case using active shunts.

Figure 4 shows the state-of-charge for various C-rates. The plot shows that for the system managed with the shunt-triggering electronics, both batteries end with SOC's equal to zero (and therefore equal to each other) after the discharge operation. However, for the system without shunt resistors, the system finishes in a situation with one over-discharged and one under-utilized battery.

## Reference

1. G.L. Plett, “Battery Pack Balancing and Power Estimation: Algorithms for Battery Management Systems Specialization”; [www.coursera.org/lecture/battery-pack-balancing-power-estimation/5-1-1-welcome-to-the-course-GWDVt](http://www.coursera.org/lecture/battery-pack-balancing-power-estimation/5-1-1-welcome-to-the-course-GWDVt).

**Application Library path:** Battery\_Design\_Module/Batteries,\_General/  
overdischarge\_protection

## Modeling Instructions



---

From the **File** menu, choose **New**.

### NEW

In the **New** window, click  **Model Wizard**.

### MODEL WIZARD

- 1 In the **Model Wizard** window, click  **OD**.
- 2 In the **Select Physics** tree, select **Electrochemistry > Batteries > Lumped Battery (lb)**.
- 3 Click **Add**.
- 4 In the **Select Physics** tree, select **Electrochemistry > Batteries > Lumped Battery (lb)**.
- 5 Click **Add**.
- 6 In the **Select Physics** tree, select **AC/DC > Electrical Circuit (cir)**.
- 7 Click **Add**.
- 8 Click  **Study**.
- 9 In the **Select Study** tree, select **General Studies > Time Dependent**.
- 10 Click  **Done**.

### GLOBAL DEFINITIONS

Add the parameter file required for setting up the physics of the **Lumped Battery** and the **Electrical Circuit** interfaces.

#### Parameters 1

- 1 In the **Model Builder** window, under **Global Definitions** click **Parameters 1**.
- 2 In the **Settings** window for **Parameters**, locate the **Parameters** section.
- 3 Click  **Load from File**.
- 4 Browse to the model's Application Libraries folder and double-click the file `overdischarge_protection_parameters.txt`.

### DEFINITIONS



Add a step function to define the short circuit initialization at the **Lumped Battery** at a given time.

#### Short

- 1 In the **Definitions** toolbar, click  **More Functions** and choose **Step**.
- 2 In the **Settings** window for **Step**, type **Short** in the **Label** text field.

$E_{OCP}$

Next add interpolation functions to define the SOC dependent equilibrium potential.

- 1 In the **Home** toolbar, click  **Functions** and choose **Local > Interpolation**.
- 2 In the **Settings** window for **Interpolation**, type  $E_{OCP}$  in the **Label** text field.
- 3 Locate the **Definition** section. From the **Data source** list, choose **File**.
- 4 In the **Filename** text field, type `overdischarge_protection_E_OCP.txt`.
- 5 Click  **Import**.
- 6 Locate the **Interpolation and Extrapolation** section. From the **Extrapolation** list, choose **Nearest function**.
- 7 Locate the **Units** section. In the **Argument** table, enter the following settings:

Argument	Unit
t	1

- 8 In the **Function** table, enter the following settings:

Function	Unit
int1	V

### **LUMPED BATTERY (LB)**

Start setting the **Lumped Battery** interface below.

- 1 In the **Model Builder** window, under **Component 1 (comp1)** click **Lumped Battery (lb)**.
- 2 In the **Settings** window for **Lumped Battery**, locate the **Operation Mode** section.
- 3 From the **Operation mode** list, choose **Circuit voltage source**.
- 4 Locate the **Initial Capacity** section. In the  $Q_{cell,0}$  text field, type  $Q_{ce110}$ .
- 5 Locate the **Initial Cell Charge Distribution** section. In the  $SOC_{cell,0}$  text field, type  $SOC_0$ .

### *Cell Equilibrium Potential 1*

- 1 In the **Model Builder** window, under **Component 1 (comp1) > Lumped Battery (lb)** click **Cell Equilibrium Potential 1**.
- 2 In the **Settings** window for **Cell Equilibrium Potential**, locate the **Open Circuit Voltage** section.
- 3 From the **Open circuit voltage input** list, choose **From definitions**.
- 4 From the  $E_{OCV,ref}$  list, choose  **$E_{OCP}$  (int1)**.

### *Voltage Losses 1*

- 1 In the **Model Builder** window, click **Voltage Losses 1**.
- 2 In the **Settings** window for **Voltage Losses**, locate the **Ohmic Overpotential** section.
- 3 In the  $\eta_{IR,1C}$  text field, type eta\_IR\_1C.
- 4 Locate the **Activation Overpotential** section. In the  $J_0$  text field, type J0.
- 5 Locate the **Concentration Overpotential** section. Select the **Include concentration overpotential** checkbox.
- 6 In the  $\tau$  text field, type tau.

### *Short Circuit 1*

- 1 In the **Physics** toolbar, click  **Global** and choose **Short Circuit**.
- 2 In the **Settings** window for **Short Circuit**, locate the **Short Circuit Conductance** section.
- 3 In the  $G_{short}$  text field, type  $G_{short} * step1((t - t_{short\_start}) / 1[s])$ .

### **LUMPED BATTERY 2 (LB2)**

Set up the second battery in a similar manner, except for the short circuit node.

- 1 In the **Model Builder** window, under **Component 1 (comp1)** click **Lumped Battery 2 (lb2)**.
- 2 In the **Settings** window for **Lumped Battery**, locate the **Operation Mode** section.
- 3 From the **Operation mode** list, choose **Circuit voltage source**.
- 4 Locate the **Initial Capacity** section. In the  $Q_{cell,0}$  text field, type Q\_cell0.
- 5 Locate the **Initial Cell Charge Distribution** section. In the  $SOC_{cell,0}$  text field, type SOC\_0.

### *Cell Equilibrium Potential 1*

- 1 In the **Model Builder** window, under **Component 1 (comp1)** > **Lumped Battery 2 (lb2)** click **Cell Equilibrium Potential 1**.
- 2 In the **Settings** window for **Cell Equilibrium Potential**, locate the **Open Circuit Voltage** section.
- 3 From the **Open circuit voltage input** list, choose **From definitions**.
- 4 From the  $E_{OCV,ref}$  list, choose **E\_OCP (int1)**.

### *Voltage Losses 1*

- 1 In the **Model Builder** window, click **Voltage Losses 1**.
- 2 In the **Settings** window for **Voltage Losses**, locate the **Ohmic Overpotential** section.
- 3 In the  $\eta_{IR,1C}$  text field, type eta\_IR\_1C.
- 4 Locate the **Activation Overpotential** section. In the  $J_0$  text field, type J0.

- 5 Locate the **Concentration Overpotential** section. Select the **Include concentration overpotential** checkbox.
- 6 In the  $\tau$  text field, type  $\tau$ .

### ELECTRICAL CIRCUIT (CIR)

Now move on to set the circuit through which the batteries are discharged in a 2s configuration as described below:

In the **Model Builder** window, under **Component 1 (comp1)** click **Electrical Circuit (cir)**.

#### Current Source 1 (I1)

- 1 In the **Electrical Circuit** toolbar, click  **Current Source**.
- 2 In the **Settings** window for **Current Source**, locate the **Node Connections** section.
- 3 In the table, enter the following settings:

Label	Node names
n	0

- 4 Locate the **Device Parameters** section. In the  $i_{src}$  text field, type  $I_{app}$ .

#### Lumped Battery 1

- 1 In the **Electrical Circuit** toolbar, click  **External I vs. U**.
- 2 In the **Settings** window for **External I vs. U**, type Lumped Battery 1 in the **Label** text field.
- 3 Locate the **Node Connections** section. In the table, enter the following settings:

Label	Node names
p	1
n	2

- 4 Locate the **External Device** section. From the  $V$  list, choose **Electric potential on circuit (lb/vI1)**.

#### Lumped Battery 2

- 1 Right-click **Lumped Battery 1** and choose **Duplicate**.
- 2 In the **Settings** window for **External I vs. U**, type Lumped Battery 2 in the **Label** text field.

3 Locate the **Node Connections** section. In the table, enter the following settings:

Label	Node names
p	2
n	3

4 Locate the **External Device** section. From the *V* list, choose **Electric potential on circuit (lb2/v11)**.

*Resistor 1 (R1)*

- 1 In the **Electrical Circuit** toolbar, click  **Resistor**.
- 2 In the **Settings** window for **Resistor**, locate the **Node Connections** section.
- 3 In the table, enter the following settings:

Label	Node names
p	3
n	0

4 Locate the **Device Parameters** section. In the *R* text field, type 10[m[Omega]].

*Volt Meter 1 (vm1)*

- 1 In the **Electrical Circuit** toolbar, click  **Volt Meter**.
- 2 In the **Settings** window for **Volt Meter**, locate the **Node Connections** section.
- 3 In the table, enter the following settings:

Label	Node names
p	1
n	3

### STUDY 1: WITHOUT SHUNTS

- 1 In the **Model Builder** window, click **Study 1**.
- 2 In the **Settings** window for **Study**, type Study 1: Without Shunts in the **Label** text field.
- 3 Locate the **Study Settings** section. Clear the **Generate default plots** checkbox.



*Step 1: Time Dependent*

- 1 In the **Model Builder** window, under **Study 1: Without Shunts** click **Step 1: Time Dependent**.
- 2 In the **Settings** window for **Time Dependent**, locate the **Study Settings** section.

- 3 In the **Output times** text field, type range (0, 100, 10000).
- 4 Click to expand the **Study Extensions** section. Select the **Auxiliary sweep** checkbox.
- 5 From the **Sweep type** list, choose **All combinations**.
- 6 Click  **Add**.
- 7 In the table, enter the following settings:

Parameter name	Parameter value list	Parameter unit
C_rate (C-rate)	0.5 2	

#### *Solution 1 (sol1)*

- 1 In the **Study** toolbar, click  **Show Default Solver**.
- 2 In the **Model Builder** window, expand the **Solution 1 (sol1)** node.
- 3 In the **Model Builder** window, expand the **Study 1: Without Shunts > Solver Configurations > Solution 1 (sol1) > Time-Dependent Solver 1** node.
- 4 Right-click **Study 1: Without Shunts > Solver Configurations > Solution 1 (sol1) > Time-Dependent Solver 1** and choose **Stop Condition**.
- 5 In the **Settings** window for **Stop Condition**, locate the **Stop Expressions** section.
- 6 Click  **Add**.
- 7 In the table, enter the following settings:

Stop expression	Stop if	Active	Description
comp1.lb2.SOC_cell<= 0.0	True (>=1)	√	Stop expression 1

- 8 In the **Study** toolbar, click  **Compute**.

## RESULTS

### *Cell Voltage*

- 1 In the **Results** toolbar, click  **ID Plot Group**.
- 2 In the **Settings** window for **ID Plot Group**, type Cell Voltage in the **Label** text field.
- 3 Locate the **Data** section. From the **Dataset** list, choose **None**.
- 4 Click to expand the **Title** section. From the **Title type** list, choose **Label**.
- 5 Locate the **Plot Settings** section.
- 6 Select the **y-axis label** checkbox. In the associated text field, type Cell Potential (V).
- 7 Locate the **Legend** section. From the **Position** list, choose **Lower right**.

### Global I

- 1 Right-click **Cell Voltage** and choose **Global**.
- 2 In the **Settings** window for **Global**, locate the **Data** section.
- 3 From the **Dataset** list, choose **Study 1: Without Shunts/Solution 1 (sol1)**.
- 4 Click **Add Expression** in the upper-right corner of the **y-Axis Data** section. From the menu, choose **Component 1 (comp1) > Lumped Battery > lb.E\_cell - Cell potential - V**.
- 5 Locate the **y-Axis Data** section. In the table, enter the following settings:

Expression	Unit	Description
lb.E_cell	V	Cell 1

- 6 Click **Add Expression** in the upper-right corner of the **y-Axis Data** section. From the menu, choose **Component 1 (comp1) > Lumped Battery 2 > lb2.E\_cell - Cell potential - V**.
- 7 Locate the **y-Axis Data** section. In the table, enter the following settings:

Expression	Unit	Description
lb2.E_cell	V	Cell 2

- 8 Click **Add Expression** in the upper-right corner of the **y-Axis Data** section. From the menu, choose **Component 1 (comp1) > Electrical Circuit > Measurements > cir.vm1.v - Voltage across Volt meter vm1 - V**.
- 9 Locate the **y-Axis Data** section. In the table, enter the following settings:

Expression	Unit	Description
cir.vm1.v	V	Total

- 10 Locate the **x-Axis Data** section. From the **Axis source data** list, choose **Time**.
- 11 Click to expand the **Coloring and Style** section. From the **Color** list, choose **Cycle (reset)**.
- 12 In the **Cell Voltage** toolbar, click  **Plot**.

### Cell Current

- 1 In the **Model Builder** window, right-click **Cell Voltage** and choose **Duplicate**.
- 2 In the **Settings** window for **ID Plot Group**, type **Cell Current** in the **Label** text field.
- 3 Locate the **Plot Settings** section. In the **y-axis label** text field, type **Cell Current (A)**.
- 4 Locate the **Axis** section. Select the **Manual axis limits** checkbox.
- 5 In the **y minimum** text field, type **-30**.
- 6 In the **y maximum** text field, type **1**.

### Global I

- 1 In the **Model Builder** window, expand the **Cell Current** node, then click **Global I**.
- 2 In the **Settings** window for **Global**, locate the **y-Axis Data** section.
- 3 Click  **Clear Table**.
- 4 Click **Replace Expression** in the upper-right corner of the **y-Axis Data** section. From the menu, choose **Component I (comp1) > Lumped Battery > lb.I\_cell - Cell current - A**.
- 5 Locate the **y-Axis Data** section. In the table, enter the following settings:

Expression	Unit	Description
lb.I_cell	A	Cell 1

- 6 Click **Add Expression** in the upper-right corner of the **y-Axis Data** section. From the menu, choose **Component I (comp1) > Lumped Battery 2 > lb2.I\_cell - Cell current - A**.
- 7 Locate the **y-Axis Data** section. In the table, enter the following settings:

Expression	Unit	Description
lb2.I_cell	A	Cell 2

- 8 In the **Cell Current** toolbar, click  **Plot**.

### State of Charge

- 1 In the **Home** toolbar, click  **Add Plot Group** and choose **ID Plot Group**.
- 2 In the **Settings** window for **ID Plot Group**, type State of Charge in the **Label** text field.
- 3 Locate the **Data** section. From the **Dataset** list, choose **None**.
- 4 Locate the **Title** section. From the **Title type** list, choose **Label**.
- 5 Locate the **Plot Settings** section.
- 6 Select the **y-axis label** checkbox. In the associated text field, type State of charge.

### Global I

- 1 Right-click **State of Charge** and choose **Global**.
- 2 In the **Settings** window for **Global**, locate the **Data** section.
- 3 From the **Dataset** list, choose **Study 1: Without Shunts/Solution 1 (sol1)**.
- 4 Click **Add Expression** in the upper-right corner of the **y-Axis Data** section. From the menu, choose **Component I (comp1) > Lumped Battery > lb.SOC\_cell - Cell state of charge - I**.

5 Locate the **y-Axis Data** section. In the table, enter the following settings:

Expression	Unit	Description
lb.SOC_cell	1	Cell 1

6 Click **Add Expression** in the upper-right corner of the **y-Axis Data** section. From the menu, choose **Component 1 (comp1) > Lumped Battery 2 > lb2.SOC\_cell - Cell state of charge - I**.

7 Locate the **y-Axis Data** section. In the table, enter the following settings:

Expression	Unit	Description
lb2.SOC_cell	1	Cell 2

8 Locate the **Coloring and Style** section. From the **Color** list, choose **Cycle (reset)**.

9 In the **State of Charge** toolbar, click  **Plot**.

The next set of instructions modify the model to include an event-based circuit, wherein the shunt resistors are plugged in or out depending on the discharge states of the batteries.

#### ADD PHYSICS

1 In the **Home** toolbar, click  **Add Physics** to open the **Add Physics** window.

2 Go to the **Add Physics** window.

3 In the tree, select **Mathematics > ODE and DAE Interfaces > Events (ev)**.

4 Click the **Add to Component 1** button in the window toolbar.

5 In the **Home** toolbar, click  **Add Physics** to close the **Add Physics** window.

#### EVENTS (EV)

##### *Discrete States 1*

1 In the **Events** toolbar, click  **Discrete States**.

2 In the **Settings** window for **Discrete States**, locate the **Discrete States** section.

3 In the table, enter the following settings:

Name	Initial value (u0)	Description
Shunt_R1_on	1	
Shunt_R2_on	1	

##### *Indicator States 1*

1 In the **Events** toolbar, click  **Indicator States**.

- 2 In the **Settings** window for **Indicator States**, locate the **Indicator Variables** section.
- 3 In the table, enter the following settings:

Name	g(v,vt,vtt,t)	Initial value (u0)	Description
discharge_lb_1	(comp1.lb.SOC_cell-0.2)* (Shunt_R1_on==1)	0	Discharge through shunt R1
discharge_lb_2	(comp1.lb2.SOC_cell-0.2)* (Shunt_R2_on==1)	0	Discharge through shunt R2

#### *Implicit Event 1*

- 1 In the **Events** toolbar, click  **Implicit Event**.
- 2 In the **Settings** window for **Implicit Event**, locate the **Event Conditions** section.
- 3 In the **Condition** text field, type discharge\_lb\_1<0.
- 4 Locate the **Reinitialization** section. In the table, enter the following settings:

	Expression
Shunt_R1_on	eps

#### *Implicit Event 2*

- 1 Right-click **Implicit Event 1** and choose **Duplicate**.
- 2 In the **Settings** window for **Implicit Event**, locate the **Event Conditions** section.
- 3 In the **Condition** text field, type discharge\_lb\_2<0.
- 4 Locate the **Reinitialization** section. In the table, enter the following settings:

	Expression
Shunt_R2_on	eps

### **ELECTRICAL CIRCUIT (CIR)**

#### *Shunt R1*

- 1 In the **Electrical Circuit** toolbar, click  **Resistor**.
- 2 In the **Settings** window for **Resistor**, type Shunt R1 in the **Label** text field.
- 3 Locate the **Device Parameters** section. In the  $R$  text field, type  $R1 * \text{Shunt\_R1\_on}$ .

4 Locate the **Node Connections** section. In the table, enter the following settings:

Label	Node names
p	1
n	2



*Shunt R2*

- 1 Right-click **Shunt R1** and choose **Duplicate**.
- 2 In the **Settings** window for **Resistor**, type Shunt R2 in the **Label** text field.
- 3 Locate the **Node Connections** section. In the table, enter the following settings:

Label	Node names
p	2
n	3

4 Locate the **Device Parameters** section. In the  $R$  text field, type  $R1*Shunt\_R2\_on$ .

#### ADD STUDY

- 1 In the **Home** toolbar, click  **Add Study** to open the **Add Study** window.
- 2 Go to the **Add Study** window.
- 3 Find the **Studies** subsection. In the **Select Study** tree, select **General Studies > Time Dependent**.
- 4 Click the **Add Study** button in the window toolbar.
- 5 In the **Home** toolbar, click  **Add Study** to close the **Add Study** window.

#### STUDY 2: WITH SHUNTS

In the **Settings** window for **Study**, type Study 2: With Shunts in the **Label** text field.

*Step 1: Time Dependent*

- 1 In the **Model Builder** window, under **Study 2: With Shunts** click **Step 1: Time Dependent**.
- 2 In the **Settings** window for **Time Dependent**, locate the **Study Settings** section.
- 3 In the **Output times** text field, type range (0, 100, 10000).
- 4 Locate the **Study Extensions** section. Select the **Auxiliary sweep** checkbox.
- 5 Click **+ Add**.

6 In the table, enter the following settings:

Parameter name	Parameter value list	Parameter unit
C_rate (C-rate)	0.5 2	



- 7 In the **Model Builder** window, click **Study 2: With Shunts**.
- 8 In the **Settings** window for **Study**, locate the **Study Settings** section.
- 9 Clear the **Generate default plots** checkbox.
- 10 In the **Study** toolbar, click  **Compute**.

## RESULTS

### *Cell Voltage*

- 1 In the **Model Builder** window, under **Results** click **Cell Voltage**.
- 2 In the **Cell Voltage** toolbar, click  **Plot**.

### *Global 2*

- 1 In the **Model Builder** window, under **Results > Cell Voltage** right-click **Global 1** and choose **Duplicate**.
- 2 In the **Settings** window for **Global**, locate the **Data** section.
- 3 From the **Dataset** list, choose **Study 2: With Shunts/Solution 2 (sol2)**.
- 4 Locate the **Coloring and Style** section. Find the **Line style** subsection. From the **Line** list, choose **Dashed**.
- 5 Click to expand the **Legends** section. Clear the **Show legends** checkbox.
- 6 Click the  **Zoom Extents** button in the **Graphics** toolbar.
- 7 In the **Cell Voltage** toolbar, click  **Plot**.

### *Global 2*



- 1 In the **Model Builder** window, under **Results > Cell Current** right-click **Global 1** and choose **Duplicate**.
- 2 In the **Settings** window for **Global**, locate the **Data** section.
- 3 From the **Dataset** list, choose **Study 2: With Shunts/Solution 2 (sol2)**.
- 4 Locate the **Coloring and Style** section. Find the **Line style** subsection. From the **Line** list, choose **Dashed**.
- 5 Locate the **Legends** section. Clear the **Show legends** checkbox.

### *Global 1*

- 1 In the **Model Builder** window, under **Results > State of Charge** click **Global 1**.

- 2 In the **Settings** window for **Global**, locate the **x-Axis Data** section.
- 3 From the **Axis source data** list, choose **Time**.

#### *Global 2*

- 1 Right-click **Results > State of Charge > Global 1** and choose **Duplicate**.
- 2 In the **Settings** window for **Global**, locate the **Data** section.
- 3 From the **Dataset** list, choose **Study 2: With Shunts/Solution 2 (sol2)**.
- 4 Locate the **Coloring and Style** section. Find the **Line style** subsection. From the **Line** list, choose **Dashed**.
- 5 Locate the **Legends** section. Clear the **Show legends** checkbox.
- 6 Click the  **Zoom Extents** button in the **Graphics** toolbar.
- 7 In the **State of Charge** toolbar, click  **Plot**.