

Model created in COMSOL Multiphysics 6.4

# Thermal Modeling of a Cylindrical Lithium-Ion Battery in 3D

## Introduction

---

This example simulates an air-cooled cylindrical 18,650 lithium-ion battery in 3D. A one-dimensional cell model is used to model the battery cell chemistry, and a three-dimensional model is used to model the temperature in the battery. The two models are coupled by the generated heat source and the average temperature; see [Figure 1](#).

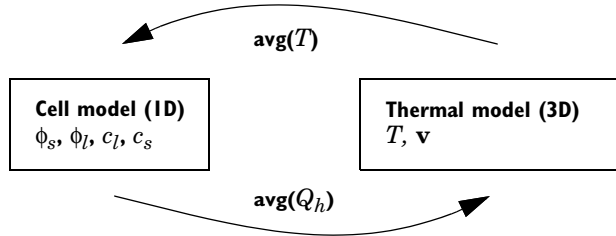

*Figure 1: Coupling between the cell and thermal model using the average values for the temperature and generated heat.*

The thermal model also includes the flow of the cooling fluid around the battery in a flow compartment, see [Figure 2](#). The fluid flow is allowed to influence the heat transfer rate. This is achieved by using a Nonisothermal Flow multiphysics node. However, the properties of the flow are not assumed to vary with temperature, so a one-way study is used. This approach is significantly less computationally demanding than solving the coupled flow, heat transfer, and electrochemistry problem. The results of this one-way approach will be compared with the coupled solution, in the [Results and Discussion](#) section.

## Model Definition

---

### CELL MODEL

The cell model is created using the Lithium-Ion Battery interface. A more detailed description on how to set up this type of model can be found in the Application Libraries example [1D Isothermal Lithium-Ion Battery](#). The cell model consists of the following three domains:

- Negative porous electrode ( $\text{Li}_x\text{C}_6$  MCMB, 55  $\mu\text{m}$ )
- Separator (30  $\mu\text{m}$ )
- Positive porous electrode ( $\text{Li}_y\text{Mn}_2\text{O}_4$ , 55  $\mu\text{m}$ )

The temperature is set to the mean temperature in the active battery material of the thermal model using a nonlocal integration coupling.

A square wave function is used to set an alternating charge/discharge current at a 7.5C rate with a cycle time of 600 s followed by a relaxing period after 1500 s; see [Figure 3](#). (A 1C rate corresponds to the charge/discharge current required to fully charge or discharge in one hour; 7.5C corresponds to a 7.5 times higher current).

The cell is set to an initial state of charge of 10%.

### THERMAL MODEL

The thermal model is made in 3D using the Heat Transfer in Solids and Fluids interface.

The geometry (see [Figure 2](#)) consists of the following domains:

- Active battery material domain (wound sheets of cell material, 65 mm high, radius 9 mm)
- Mandrel (nylon isolator around which the battery cell sheets are wound, 2 mm radius)
- Cylindrical battery connector on top of the battery (steel, 3 mm thick)
- Flow compartment (air)

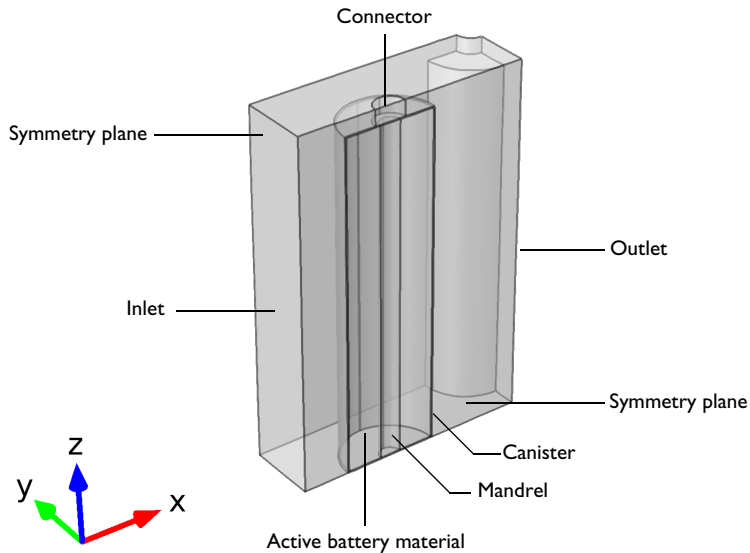

*Figure 2: Geometry of the thermal model.*

The battery canister (0.25 mm thick) is not included as a domain in the geometry, since the effect of the steel canister on the temperature profile are small, as can be seen in the [Thermal Modeling of a Cylindrical Lithium-Ion Battery in 2D](#) model. The heat source term in the active battery material domain is however scaled to account for the lack of heat generation in the current collectors, and for the canister thickness. This scaled heat source is obtained by multiplying the volumetric heat source from the 1D Li-ion battery model by two factors. The first factor is the fraction of the total 1D model in which heat is generated. That is the sum of lengths of the negative electrode, separator and the positive electrode, divided the total cell length, which also includes the lengths of the two current collectors. The second factor is the fraction of the total 3D cylindrical cell geometry in which heat is generated. The volume in which heat is generated is the total volume of the cell (which includes both the homogenized wound layers of the battery material, the central mandrel and the outer can), minus the volume of the mandrel and the volume of the outer can. This heat source is then divided by the total volume of battery material, which is the difference between the total cell volume and the mandrel volume. Thus, the following expression for the 3D heat source is obtained:

$$Q_{h, 3D} = Q_{h, 1D} \frac{L_{\text{neg}} + L_{\text{sep}} + L_{\text{pos}}}{L_{\text{batt}}} \frac{((r_{\text{batt}} - d_{\text{can}})^2 - r_{\text{mandrel}}^2)(h_{\text{batt}} - 2d_{\text{can}})}{(r_{\text{batt}}^2 - r_{\text{mandrel}}^2)h_{\text{batt}}}$$

The battery is placed in a battery pack consisting of a matrix of batteries.

The thermal conductivity in the active battery material is anisotropic due to the spiral winding of the battery cell layers. The thermal conductivity, density, heat capacity and heat source in the battery are set up in the same way as in the [Thermal Modeling of a Cylindrical Lithium-Ion Battery in 2D](#) model. A cylindrical coordinate system is added in the model in order to handle the orthotropic thermal conductivity in the active material.

The heat source based in the active battery domain is set to the average of the generated heat in cell model using a nonlocal coupling integration variable. At the inlet boundary a temperature of 298.15 K is specified whereas an outflow condition is applied at the outlet. All other external boundaries are thermally isolated. The initial temperature of the battery is 298.15 K.

For the flow, an inlet velocity of 0.1 m/s is applied at the inlet, and a pressure of 1 atm is set at the outlet. Symmetry boundary conditions are applied to the symmetry planes. No Slip conditions are applied to the battery walls.

The problem is solved in three steps. In the first step the steady state flow at 298.15 K is solved for. The second step solves for the potentials in battery model at  $t = 0$ . The third step is a time-dependent study of the full problem, where the steady state solution from

the first two steps are used to set the initial values for the potentials. The velocity and pressure of the cooling gas is assumed to be almost unaffected by the heat transfer from the battery.

## Results and Discussion

Figure 3 shows the cell potential and the load cycle current.

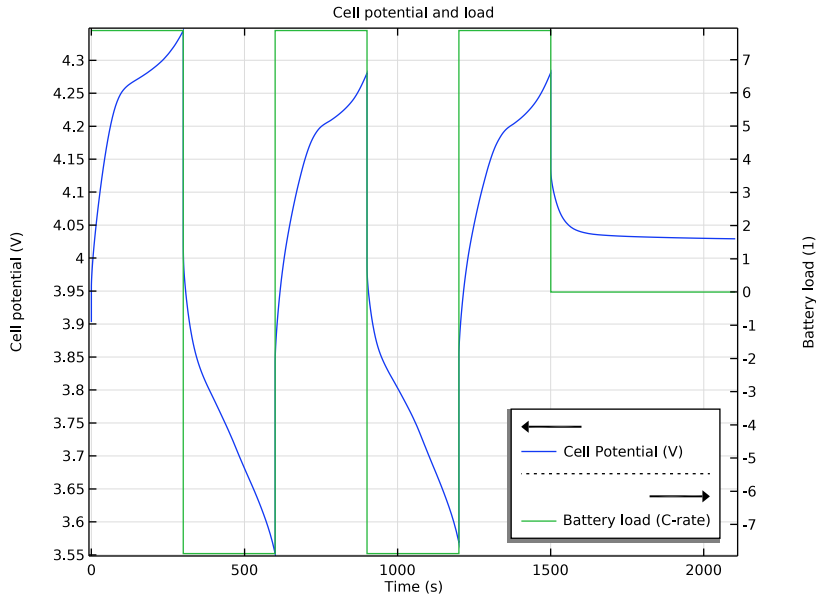

Figure 3: Cell potential and current load.

Figure 4 shows the minimum, maximum, and average temperatures of the battery during the simulation. The difference in heating rate between charge and discharge is due to the difference in entropy change for the charge and discharge reactions (set by the  $dE_{eq}/dT$  parameter).

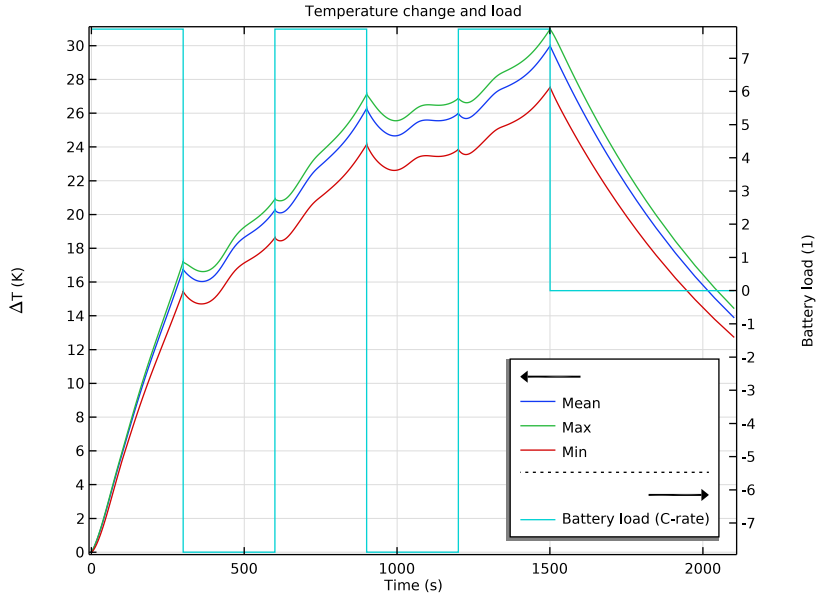

Figure 4: Minimum, mean, and maximum temperature.

Figure 5 shows the temperature in the battery and streamlines for the flow at 1500 s. The temperature maximum is located in the active battery material toward the thermally isolated end.

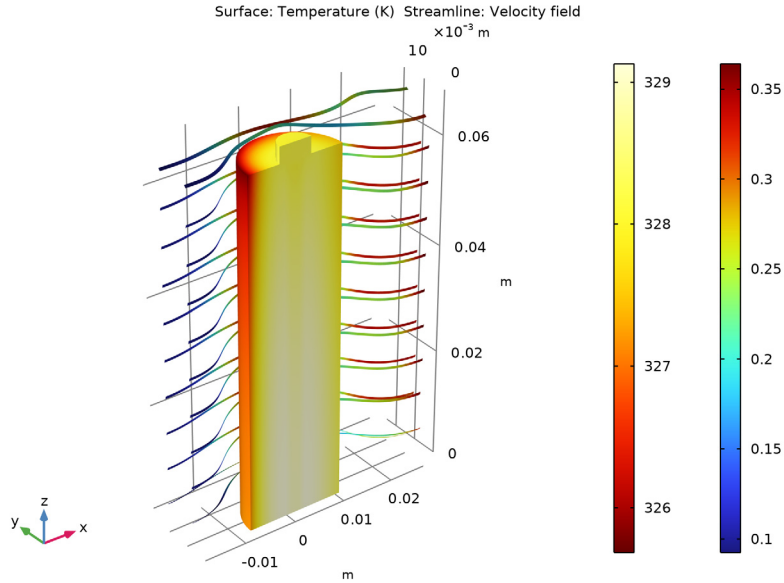

Figure 5: Temperature and flow at  $t = 1500$  s.

Figure 6 shows the difference in battery temperature and airflow streamlines between the coupled solution and the one-way solution. The differences are calculated using a Join dataset. In this case, the one-way solution is very similar to the coupled one, since only the fluid viscosity is temperature-dependent. The details of the flow pattern do change, but with a magnitude that is only a few percent of the total fluid flow velocity. The one-way calculation completes in a fraction of the time that the coupled calculation requires. This usage of the Nonisothermal Flow multiphysics feature in a one-way study to compute flow, heat, and the battery electrochemistry illustrates one key simplification that might be used in many thermal battery models. At the same time, checking the assumption is simple.

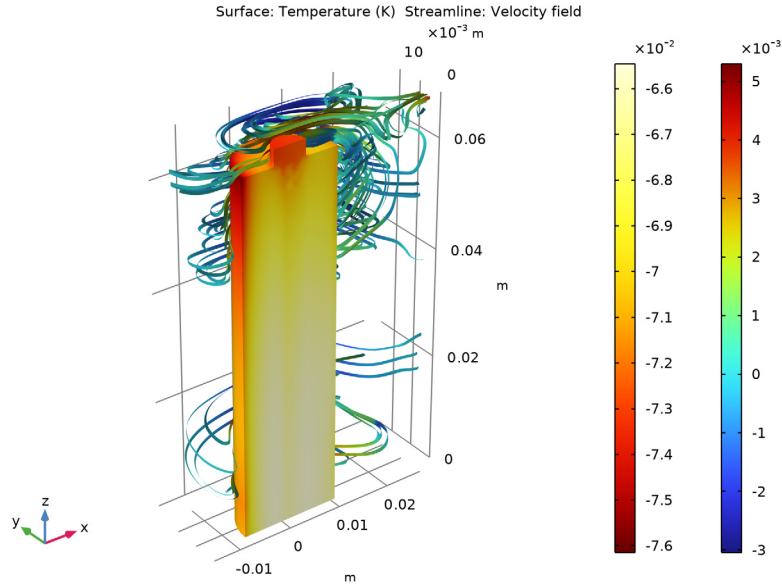

Figure 6: Differences in battery temperature and fluid flow streamlines between the coupled and one-way solutions after 2100 s.

### Notes About the COMSOL Implementation

To improve to convergence of the time-dependent solver, the function `nojac()` is used when setting up the nonlocal couplings for the average temperature and heat source.

**Application Library path:** Battery\_Design\_Module/Thermal\_Management/li\_battery\_thermal\_3d

### Modeling Instructions

#### APPLICATION LIBRARIES

- 1 From the **File** menu, choose **Application Libraries**.
- 2 In the **Application Libraries** window, select **Battery Design Module > Thermal Management > li\_battery\_Id\_for\_thermal\_models** in the tree.

3 Click  **Open**.

## LITHIUM-ION BATTERY (LIION)

### Load Cycle 1

- 1 In the **Model Builder** window, expand the **Component 1 (comp1) > Lithium-Ion Battery (liion)** node.
- 2 Right-click **Lithium-Ion Battery (liion)** and choose **Load Cycle**.
- 3 Select Boundary 4 only.
- 4 In the **Settings** window for **Load Cycle**, locate the **Load Type** section.
- 5 From the list, choose **Galvanostatic**.

### Subloop 1

- 1 In the **Physics** toolbar, click  **Attributes** and choose **Subloop**.
- 2 In the **Settings** window for **Subloop**, locate the **Subloop Break Conditions** section.
- 3 Select the **Number of completed subloop cycles** checkbox.
- 4 In the  $N_{\text{subcycles,max}}$  text field, type 2.

### C Rate 1

- 1 In the **Physics** toolbar, click  **Attributes** and choose **C Rate**.
- 2 Select Boundary 4 only.
- 3 In the **Settings** window for **C Rate**, locate the **C-Rate Multiple** section.
- 4 In the  $C_{\text{set}}$  text field, type 7.5.
- 5 Locate the **Continuation Conditions** section. Select the **Elapsed time** checkbox.
- 6 In the  $t_{\text{max}}$  text field, type  $t_{\text{pulse}}$ .

### Subloop 1

In the **Model Builder** window, click **Subloop 1**.

### C Rate 2

- 1 In the **Physics** toolbar, click  **Attributes** and choose **C Rate**.
- 2 In the **Settings** window for **C Rate**, locate the **C-Rate Multiple** section.
- 3 In the  $C_{\text{set}}$  text field, type -7.5.
- 4 Locate the **Continuation Conditions** section. Select the **Elapsed time** checkbox.
- 5 In the  $t_{\text{max}}$  text field, type  $t_{\text{pulse}}$ .

### *Load Cycle 1*

In the **Model Builder** window, under **Component 1 (comp1) > Lithium-Ion Battery (liion)** click **Load Cycle 1**.

### *C Rate 1*

- 1 In the **Physics** toolbar, click  **Attributes** and choose **C Rate**.
- 2 In the **Settings** window for **C Rate**, locate the **C-Rate Multiple** section.
- 3 In the  $C_{\text{set}}$  text field, type 7.5.
- 4 Locate the **Continuation Conditions** section. Select the **Elapsed time** checkbox.
- 5 In the  $t_{\text{max}}$  text field, type  $t_{\text{pulse}}$ .

### *Load Cycle 1*

In the **Model Builder** window, click **Load Cycle 1**.

### *Rest 1*

- 1 In the **Physics** toolbar, click  **Attributes** and choose **Rest**.
- 2 In the **Settings** window for **Rest**, locate the **Continuation Conditions** section.
- 3 Clear the **Elapsed time** checkbox.



### *Load Cycle 1*

- 1 In the **Model Builder** window, click **Load Cycle 1**.
- 2 In the **Settings** window for **Load Cycle**, locate the **Probes** section.
- 3 Select the **Applied voltage** checkbox.
- 4 Select the **Applied current** checkbox.

## **ADD COMPONENT**

In the **Model Builder** window, right-click the root node and choose **Add Component > 3D**.

## **ADD PHYSICS**

- 1 In the **Home** toolbar, click  **Add Physics** to open the **Add Physics** window.
- 2 Go to the **Add Physics** window.
- 3 In the tree, select **Fluid Flow > Single-Phase Flow > Laminar Flow (spf)**.
- 4 Click the **Add to Component 2** button in the window toolbar.
- 5 In the tree, select **Heat Transfer > Heat Transfer in Solids and Fluids (ht)**.
- 6 Click the **Add to Component 2** button in the window toolbar.
- 7 In the **Home** toolbar, click  **Add Physics** to close the **Add Physics** window.

## MULTIPHYSICS

Add a **Nonisothermal flow** multiphysics node to set up the velocity in heat transfer and to account for the multiphysics stabilization.

### *Nonisothermal Flow 1 (nitf1)*

In the **Physics** toolbar, click  **Multiphysics Couplings** and choose **Domain > Nonisothermal Flow**.

## GLOBAL DEFINITIONS

### *Parameters 2*

- 1 In the **Home** toolbar, click  **Parameters** and choose **Add > Parameters**.
- 2 In the **Settings** window for **Parameters**, locate the **Parameters** section.
- 3 In the table, enter the following settings:

Name	Expression	Value	Description
h_connector	3[mm]	0.003 m	Connector height
r_connector	3[mm]	0.003 m	Connector radius
s_inlet	2*r_batt	0.018 m	Length of inlet flow region
s_matrix	3*r_batt	0.027 m	Battery-battery distance in matrix
V_in	0.1[m/s]	0.1 m/s	Inlet velocity
A_cell	0.1[m^2]	0.1 m <sup>2</sup>	Cell cross-sectional area

## LITHIUM-ION BATTERY (LIION)



- 1 In the **Model Builder** window, under **Component 1 (comp1)** click **Lithium-Ion Battery (liion)**.
- 2 In the **Settings** window for **Lithium-Ion Battery**, locate the **Cross-Sectional Area** section.
- 3 In the  $A_c$  text field, type  $A_{cell}$ .

## GEOMETRY 2

In the **Model Builder** window, under **Component 2 (comp2)** click **Geometry 2**.

### *Cylinder 1 (cyl1)*



- 1 In the **Geometry** toolbar, click  **Cylinder**.
- 2 In the **Settings** window for **Cylinder**, locate the **Size and Shape** section.
- 3 In the **Radius** text field, type  $r_{batt}$ .
- 4 In the **Height** text field, type  $h_{batt}$ .

- 5 Click  **Build Selected**.
- 6 Click the  **Transparency** button in the **Graphics** toolbar.



#### *Cylinder 2 (cyl2)*

- 1 In the **Geometry** toolbar, click  **Cylinder**.
- 2 In the **Settings** window for **Cylinder**, locate the **Size and Shape** section.
- 3 In the **Radius** text field, type `r_mandrel`.
- 4 In the **Height** text field, type `h_batt`.



#### *Cylinder 3 (cyl3)*

- 1 In the **Geometry** toolbar, click  **Cylinder**.
- 2 In the **Settings** window for **Cylinder**, locate the **Size and Shape** section.
- 3 In the **Radius** text field, type `r_connector`.
- 4 In the **Height** text field, type `h_connector`.
- 5 Locate the **Position** section. In the **z** text field, type `h_batt`.
- 6 Click  **Build Selected**.



#### *Union 1 (uni1)*

- 1 In the **Geometry** toolbar, click  **Booleans and Partitions** and choose **Union**.
- 2 Click in the **Graphics** window and then press `Ctrl+A` to select all objects.
- 3 In the **Settings** window for **Union**, click  **Build Selected**.



#### *Block 1 (blk1)*

- 1 In the **Geometry** toolbar, click  **Block**.
- 2 In the **Settings** window for **Block**, locate the **Size and Shape** section.
- 3 In the **Width** text field, type `2*r_batt`.
- 4 In the **Depth** text field, type `r_batt`.
- 5 In the **Height** text field, type `h_batt+h_connector`.
- 6 Locate the **Position** section. In the **x** text field, type `-r_batt`.
- 7 Click  **Build Selected**.



#### *Intersection 1 (int1)*

- 1 In the **Geometry** toolbar, click  **Booleans and Partitions** and choose **Intersection**.
- 2 Click in the **Graphics** window and then press `Ctrl+A` to select both objects.
- 3 In the **Settings** window for **Intersection**, click  **Build Selected**.



### Block 2 (blk2)

- 1 In the **Geometry** toolbar, click  **Block**.
- 2 In the **Settings** window for **Block**, locate the **Size and Shape** section.
- 3 In the **Width** text field, type  $s\_inlet+s\_matrix$ .
- 4 In the **Depth** text field, type  $s\_matrix/2$ .
- 5 In the **Height** text field, type  $h\_batt-5[mm]$ .
- 6 Locate the **Position** section. In the **x** text field, type  $-s\_inlet$ .
- 7 Click  **Build Selected**.

### Block 3 (blk3)

- 1 In the **Geometry** toolbar, click  **Block**.
- 2 In the **Settings** window for **Block**, locate the **Size and Shape** section.
- 3 In the **Width** text field, type  $s\_inlet+s\_matrix$ .
- 4 In the **Depth** text field, type  $s\_matrix/2$ .
- 5 In the **Height** text field, type  $h\_connector+5[mm]$ .
- 6 Locate the **Position** section. In the **x** text field, type  $-s\_inlet$ .
- 7 In the **z** text field, type  $h\_batt-5[mm]$ .
- 8 Click  **Build Selected**.

### Cylinder 4 (cyl4)

- 1 In the **Geometry** toolbar, click  **Cylinder**.
- 2 In the **Settings** window for **Cylinder**, locate the **Size and Shape** section.
- 3 In the **Radius** text field, type  $r\_batt$ .
- 4 In the **Height** text field, type  $h\_batt$ .
- 5 Locate the **Position** section. In the **x** text field, type  $s\_matrix$ .
- 6 In the **y** text field, type  $s\_matrix/2$ .
- 7 Click  **Build Selected**.

### Cylinder 5 (cyl5)

- 1 In the **Geometry** toolbar, click  **Cylinder**.
- 2 In the **Settings** window for **Cylinder**, locate the **Size and Shape** section.
- 3 In the **Radius** text field, type  $r\_connector$ .
- 4 In the **Height** text field, type  $h\_connector$ .
- 5 Locate the **Position** section. In the **x** text field, type  $s\_matrix$ .

6 In the **y** text field, type `s_matrix/2`.

7 In the **z** text field, type `h_batt`.

8 Click  **Build Selected**.

#### *Difference I (dif1)*

1 In the **Geometry** toolbar, click  **Booleans and Partitions** and choose **Difference**.

2 Select the objects **blk2**, **blk3**, and **int1** only.

3 In the **Settings** window for **Difference**, locate the **Difference** section.

4 Click to select the  **Activate Selection** toggle button for **Objects to subtract**.

5 Select the objects **cyl4** and **cyl5** only.

6 Click  **Build Selected**.

#### *Mesh Control Faces I (mcf1)*

1 In the **Geometry** toolbar, click  **Virtual Operations** and choose **Mesh Control Faces**.

2 On the object **fin**, select Boundaries 6, 15, and 26 only.

It might be easier to select the domains by using the **Selection List** window. To open this window, in the **Home** toolbar click **Windows** and choose **Selection List**. (If you are running the cross-platform desktop, you find **Windows** in the main menu.)

3 Click the  **Zoom Extents** button in the **Graphics** toolbar.

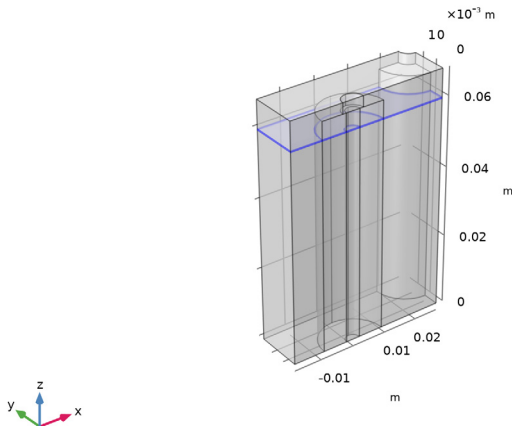

## DEFINITIONS (COMP2)

### *Flow Compartment*

- 1 In the **Definitions** toolbar, click  **Explicit**.
- 2 In the **Settings** window for **Explicit**, type Flow Compartment in the **Label** text field.
- 3 Select Domain 1 only.

### *Active Battery Material*

- 1 In the **Definitions** toolbar, click  **Explicit**.
- 2 In the **Settings** window for **Explicit**, type Active Battery Material in the **Label** text field.
- 3 Select Domain 2 only.

### *Battery Connector*

- 1 In the **Definitions** toolbar, click  **Explicit**.
- 2 In the **Settings** window for **Explicit**, type Battery Connector in the **Label** text field.
- 3 Select Domain 3 only.

### *Mandrel*

- 1 In the **Definitions** toolbar, click  **Explicit**.
- 2 In the **Settings** window for **Explicit**, type Mandrel in the **Label** text field.
- 3 Select Domain 4 only.

### *Inlet*

- 1 In the **Definitions** toolbar, click  **Explicit**.
- 2 In the **Settings** window for **Explicit**, type Inlet in the **Label** text field.
- 3 Locate the **Input Entities** section. From the **Geometric entity level** list, choose **Boundary**.
- 4 Select Boundary 1 only.

### *Outlet*

- 1 In the **Definitions** toolbar, click  **Explicit**.
- 2 In the **Settings** window for **Explicit**, type Outlet in the **Label** text field.
- 3 Locate the **Input Entities** section. From the **Geometric entity level** list, choose **Boundary**.
- 4 Select Boundary 26 only.

### *Symmetry planes*

- 1 In the **Definitions** toolbar, click  **Explicit**.
- 2 In the **Settings** window for **Explicit**, type Symmetry planes in the **Label** text field.

- 3 Locate the **Input Entities** section. From the **Geometric entity level** list, choose **Boundary**.
- 4 Select Boundaries 2, 5, and 22 only.

*Can*

- 1 In the **Definitions** toolbar, click  **Explicit**.
- 2 In the **Settings** window for **Explicit**, type *Can* in the **Label** text field.
- 3 Locate the **Input Entities** section. From the **Geometric entity level** list, choose **Boundary**.
- 4 Select Boundaries 7–9, 12, 16, 17, and 20 only.

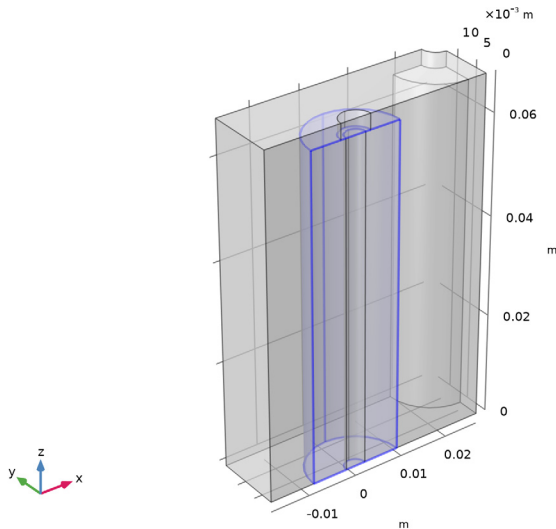

*Average 1 (aveop1)*

Define a nonlocal coupling for the average temperature in the active battery material of the 3D thermal model to use in the 1D battery model.

- 1 In the **Definitions** toolbar, click  **Nonlocal Couplings** and choose **Average**.
- 2 In the **Settings** window for **Average**, locate the **Source Selection** section.
- 3 From the **Selection** list, choose **Active Battery Material**.

### SHARED PROPERTIES

Now go to Component 1 (the 1D battery model) and define a model input for the average temperature from the 3D thermal model. Use `nojac()` to improve the time-dependent solver convergence.

### Model Input 1

- 1 In the **Model Builder** window, under **Component 1 (comp1) > Definitions > Shared Properties** click **Model Input 1**.
- 2 In the **Settings** window for **Model Input**, locate the **Definition** section.
- 3 In the text field, type `nojac(comp2.aveop1(comp2.T))`.

### DEFINITIONS (COMP1)

#### Average 2 (aveop2)

- 1 In the **Definitions** toolbar, click  **Nonlocal Couplings** and choose **Average**.  
This average operator defined in Component 1 for the 1D battery cell model is used for calculating a mean heat source for coupling to the 3D heat transfer model.
- 2 In the **Settings** window for **Average**, locate the **Source Selection** section.
- 3 From the **Selection** list, choose **All domains**.

### DEFINITIONS (COMP2)

Now go to Component 2 (the 3D heat transfer model) and define a variable for the heat source. Use `nojac()` to improve the time-dependent solver convergence.

- 1 In the **Model Builder** window, under **Component 2 (comp2)** click **Definitions**.
- 2 Click the **Component 2** node.

#### Variables 1

- 1 In the **Definitions** toolbar, click  **Local Variables**.
- 2 In the **Settings** window for **Variables**, locate the **Variables** section.
- 3 In the table, enter the following settings:

Name	Expression	Unit	Description
Qh	<code>nojac(comp1.aveop2(comp1.liion.Qh))*(L_neg+L_sep+L_pos)/L_batt*((r_batt-d_can)^2-r_mandrel^2)*(h_batt-d_can^2)/((r_batt^2-r_mandrel^2)*h_batt)</code>	W/m <sup>3</sup>	Average heat source from 1d battery model
r	<code>sqrt(x^2+y^2)</code>	m	Radius

## DEFINITIONS (COMP1)

*Load Cycle Probe (liion\_lcl\_volt)*

- 1 In the **Model Builder** window, under **Component 1 (comp1)** > **Definitions** click **Load Cycle Probe (liion\_lcl\_volt)**.
- 2 In the **Settings** window for **Global Variable Probe**, click to expand the **Table and Window Settings** section.
- 3 Click  **Add Plot Window**.

## DEFINITIONS (COMP2)

In the **Model Builder** window, under **Component 2 (comp2)** click **Definitions**.

*Domain Probe 1 (dom1)*

- 1 In the **Definitions** toolbar, click  **Probes** and choose **Domain Probe**.
- 2 In the **Settings** window for **Domain Probe**, type MeanT in the **Variable name** text field.
- 3 Locate the **Source Selection** section. From the **Selection** list, choose **Active Battery Material**.
- 4 Locate the **Expression** section. In the **Expression** text field, type T-T\_inlet.
- 5 Click to expand the **Table and Window Settings** section. From the **Plot window** list, choose **Probe Plot 1**.

*Domain Probe 2 (dom2)*



- 1 In the **Definitions** toolbar, click  **Probes** and choose **Domain Probe**.
- 2 In the **Settings** window for **Domain Probe**, locate the **Probe Type** section.
- 3 From the **Type** list, choose **Maximum**.
- 4 In the **Variable name** text field, type MaxT.
- 5 Locate the **Source Selection** section. From the **Selection** list, choose **Active Battery Material**.
- 6 Locate the **Expression** section. In the **Expression** text field, type T-T\_inlet.
- 7 Locate the **Table and Window Settings** section. From the **Plot window** list, choose **Probe Plot 1**.

*Domain Probe 3 (dom3)*

- 1 In the **Definitions** toolbar, click  **Probes** and choose **Domain Probe**.
- 2 In the **Settings** window for **Domain Probe**, locate the **Probe Type** section.
- 3 From the **Type** list, choose **Minimum**.
- 4 In the **Variable name** text field, type MinT.

- 5 Locate the **Source Selection** section. From the **Selection** list, choose **Active Battery Material**.
- 6 Locate the **Expression** section. In the **Expression** text field, type T-T\_inlet.
- 7 Locate the **Table and Window Settings** section. From the **Plot window** list, choose **Probe Plot I**.

#### ADD MATERIAL

- 1 In the **Materials** toolbar, click  **Add Material** to open the **Add Material** window.
- 2 Go to the **Add Material** window.
- 3 In the tree, select **Built-in > Steel AISI 4340**.
- 4 Click the **Add to Component** button in the window toolbar.
- 5 In the tree, select **Built-in > Nylon**.
- 6 Click the **Add to Component** button in the window toolbar.
- 7 In the tree, select **Built-in > Air**.
- 8 Click the **Add to Component** button in the window toolbar.
- 9 In the tree, select **Built-in > Steel AISI 4340**.
- 10 Click the **Add to Component** button in the window toolbar.
- 11 In the **Materials** toolbar, click  **Add Material** to close the **Add Material** window.

#### MATERIALS

##### *Steel AISI 4340 (mat4)*

- 1 In the **Settings** window for **Material**, locate the **Geometric Entity Selection** section.
- 2 From the **Selection** list, choose **Battery Connector**.

##### *Nylon (mat5)*

- 1 In the **Model Builder** window, click **Nylon (mat5)**.
- 2 In the **Settings** window for **Material**, locate the **Geometric Entity Selection** section.
- 3 From the **Selection** list, choose **Mandrel**.

##### *Air (mat6)*

- 1 In the **Model Builder** window, click **Air (mat6)**.
- 2 In the **Settings** window for **Material**, locate the **Geometric Entity Selection** section.
- 3 From the **Selection** list, choose **Flow Compartment**.

*Steel AISI 4340.1 (mat7)*

- 1 In the **Model Builder** window, click **Steel AISI 4340.1 (mat7)**.
- 2 In the **Settings** window for **Material**, locate the **Geometric Entity Selection** section.
- 3 From the **Geometric entity level** list, choose **Boundary**.
- 4 From the **Selection** list, choose **Can**.

#### **DEFINITIONS (COMP2)**

Add a cylindrical coordinate system to handle the orthotropic thermal conductivity in the active battery material.

*Cylindrical System 2 (sys2)*

In the **Definitions** toolbar, click  **Coordinate Systems** and choose **Cylindrical System**.

#### **HEAT TRANSFER IN SOLIDS AND FLUIDS (HT)**

*Solid 2*

- 1 In the **Physics** toolbar, click  **Domains** and choose **Solid**.
- 2 In the **Settings** window for **Solid**, locate the **Domain Selection** section.
- 3 From the **Selection** list, choose **Active Battery Material**.
- 4 Locate the **Coordinate System Selection** section. From the **Coordinate system** list, choose **Cylindrical System 2 (sys2)**.
- 5 Locate the **Heat Conduction, Solid** section. From the  $k$  list, choose **User defined**. From the list, choose **Diagonal**.
- 6 Specify the  $k$  matrix as

kT_batt_r	0	0
0	kT_batt_ang	0
0	0	kT_batt_ang

- 7 Locate the **Thermodynamics, Solid** section. From the  $\rho$  list, choose **User defined**. In the associated text field, type rho\_batt.
- 8 From the  $C_p$  list, choose **User defined**. In the associated text field, type Cp\_batt.

*Heat Source 1*

- 1 In the **Physics** toolbar, click  **Domains** and choose **Heat Source**.
- 2 In the **Settings** window for **Heat Source**, locate the **Domain Selection** section.
- 3 From the **Selection** list, choose **Active Battery Material**.

4 Locate the **Heat Source** section. In the  $Q_0$  text field, type  $Qh$ .

#### LAMINAR FLOW (SPF)

1 In the **Model Builder** window, under **Component 2 (comp2)** click **Laminar Flow (spf)**.

2 In the **Settings** window for **Laminar Flow**, locate the **Domain Selection** section.

3 From the **Selection** list, choose **Flow Compartment**.

#### HEAT TRANSFER IN SOLIDS AND FLUIDS (HT)

##### *Fluid 1*

1 In the **Model Builder** window, under **Component 2 (comp2)** > **Heat Transfer in Solids and Fluids (ht)** click **Fluid 1**.

2 In the **Settings** window for **Fluid**, locate the **Domain Selection** section.

3 From the **Selection** list, choose **Flow Compartment**.

##### *Temperature 1*

1 In the **Physics** toolbar, click  **Boundaries** and choose **Temperature**.

2 In the **Settings** window for **Temperature**, locate the **Boundary Selection** section.

3 From the **Selection** list, choose **Inlet**.

4 Locate the **Temperature** section. In the  $T_0$  text field, type  $T_{inlet}$ .

##### *Outflow 1*

1 In the **Physics** toolbar, click  **Boundaries** and choose **Outflow**.

2 In the **Settings** window for **Outflow**, locate the **Boundary Selection** section.

3 From the **Selection** list, choose **Outlet**.

#### LAMINAR FLOW (SPF)

In the **Model Builder** window, under **Component 2 (comp2)** click **Laminar Flow (spf)**.

##### *Outlet 1*

1 In the **Physics** toolbar, click  **Boundaries** and choose **Outlet**.

2 In the **Settings** window for **Outlet**, locate the **Boundary Selection** section.

3 From the **Selection** list, choose **Outlet**.

4 Locate the **Pressure Conditions** section. Select the **Normal flow** checkbox.

##### *Inlet 1*

1 In the **Physics** toolbar, click  **Boundaries** and choose **Inlet**.

2 In the **Settings** window for **Inlet**, locate the **Boundary Selection** section.

- 3 From the **Selection** list, choose **Inlet**.
- 4 Locate the **Velocity** section. In the  $U_0$  text field, type  $V_{in}$ .

#### *Symmetry 1*

- 1 In the **Physics** toolbar, click  **Boundaries** and choose **Symmetry**.
- 2 In the **Settings** window for **Symmetry**, locate the **Boundary Selection** section.
- 3 From the **Selection** list, choose **Symmetry planes**.

### **HEAT TRANSFER IN SOLIDS AND FLUIDS (HT)**

- 1 In the **Model Builder** window, under **Component 2 (comp2)** click **Heat Transfer in Solids and Fluids (ht)**.
- 2 In the **Settings** window for **Heat Transfer in Solids and Fluids**, locate the **Physical Model** section.
- 3 In the  $T_{ref}$  text field, type  $T_{init}$ .

#### *Initial Values 1*

- 1 In the **Model Builder** window, under **Component 2 (comp2)** > **Heat Transfer in Solids and Fluids (ht)** click **Initial Values 1**.
- 2 In the **Settings** window for **Initial Values**, locate the **Initial Values** section.
- 3 In the  $T$  text field, type  $T_{init}$ .

### **MESH 2**

#### *Size 1*

- 1 In the **Model Builder** window, under **Component 2 (comp2)** right-click **Mesh 2** and choose **Size**.
- 2 In the **Settings** window for **Size**, locate the **Geometric Entity Selection** section.
- 3 From the **Geometric entity level** list, choose **Domain**.
- 4 From the **Selection** list, choose **Flow Compartment**.
- 5 Locate the **Element Size** section. From the **Calibrate for** list, choose **Fluid dynamics**.
- 6 From the **Predefined** list, choose **Fine**.

#### *Swept 1*



- 1 In the **Mesh** toolbar, click  **Swept**.
- 2 In the **Settings** window for **Swept**, locate the **Domain Selection** section.
- 3 From the **Geometric entity level** list, choose **Domain**.
- 4 Select Domains 1, 2, and 4 only.

5 Locate the **Mesh Generation** section. From the **Elements** list, choose **Prisms**.

#### *Distribution 1*

- 1 Right-click **Swept 1** and choose **Distribution**.
- 2 In the **Settings** window for **Distribution**, locate the **Distribution** section.
- 3 In the **Number of elements** text field, type 10.
- 4 Click  **Build Selected**.

#### *Free Tetrahedral 1*

- 1 In the **Mesh** toolbar, click  **Free Tetrahedral**.
- 2 In the **Settings** window for **Free Tetrahedral**, click to expand the **Control Entities** section.
- 3 From the **Smooth across removed control entities** list, choose **Off**.
- 4 Click  **Build Selected**.

#### *Boundary Layers 1*

- 1 In the **Mesh** toolbar, click  **Boundary Layers**.
- 2 In the **Settings** window for **Boundary Layers**, locate the **Geometric Entity Selection** section.
- 3 From the **Geometric entity level** list, choose **Domain**.
- 4 From the **Selection** list, choose **Flow Compartment**.

#### *Boundary Layer Properties*

- 1 In the **Model Builder** window, click **Boundary Layer Properties**.

2 Select Boundaries 3, 4, 7, 9, 11, 19, 20, and 23–25 only.

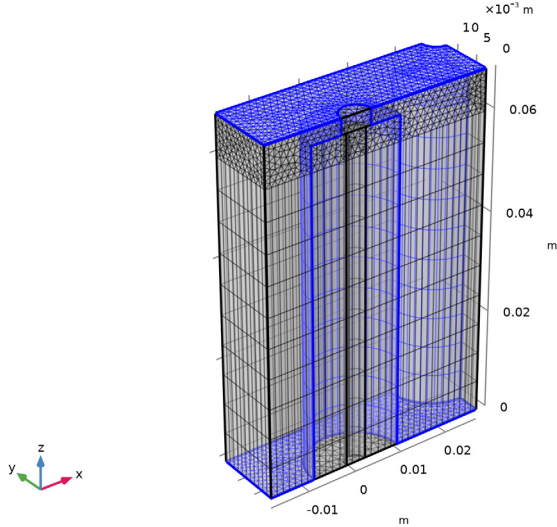

3 In the **Settings** window for **Boundary Layer Properties**, locate the **Layers** section.

4 In the **Number of layers** text field, type 2.

5 From the **Thickness specification** list, choose **First layer**.

6 In the **Thickness** text field, type  $2e-4$ .

#### *Boundary Layers 1*

1 In the **Model Builder** window, click **Boundary Layers 1**.

2 In the **Settings** window for **Boundary Layers**, click to expand the **Transition** section.

3 Clear the **Smooth transition to interior mesh** checkbox.

4 Click  **Build Selected**.

#### **ADD STUDY**

1 In the **Home** toolbar, click  **Add Study** to open the **Add Study** window.

2 Go to the **Add Study** window.

3 Find the **Studies** subsection. In the **Select Study** tree, select **General Studies > Stationary**.

4 Click the **Add Study** button in the window toolbar.

5 In the **Home** toolbar, click  **Add Study** to close the **Add Study** window.

## STUDY 1

### Step 1: Stationary

- 1 In the **Settings** window for **Stationary**, locate the **Physics and Variables Selection** section.
- 2 In the **Solve for** column of the table, under **Component 1 (comp1)**, clear the checkbox for **Lithium-Ion Battery (liion)**.
- 3 In the **Solve for** column of the table, under **Component 2 (comp2)**, clear the checkbox for **Heat Transfer in Solids and Fluids (ht)**.
- 4 In the **Solve for** column of the table, under **Component 2 (comp2) > Multiphysics**, clear the checkbox for **Nonisothermal Flow 1 (nitf1)**.

### Step 2: Current Distribution Initialization

In the **Study** toolbar, click  **More Study Steps** and choose **Other > Current Distribution Initialization**.

### Step 3: Time Dependent

- 1 In the **Study** toolbar, click  **Time Dependent**.
- 2 In the **Settings** window for **Time Dependent**, locate the **Study Settings** section.
- 3 In the **Output times** text field, type 0 2100.
- 4 Locate the **Physics and Variables Selection** section. In the **Solve for** column of the table, under **Component 2 (comp2)**, clear the checkbox for **Laminar Flow (spf)**.

### Solution 1 (sol1)

By making a few further changes to the time-dependent solver, we can improve convergence. The strict time stepping is chosen to allow us to control what times the solver solves for. As we know that the model starts with a step in current density at time 0, manually selecting a small initial step size helps convergence. Without it, the solver will start with a larger step size (the default 0.1% of the end time) where it cannot find convergence. Using the Automatic (Newton) solver is suitable for the nonlinear electrochemistry problem. Moving the segregated step for the electrochemistry problem to the top can also yield a small additional speedup, since the 1D electrochemical component is what yields the heat source.

- 1 In the **Study** toolbar, click  **Show Default Solver**.
- 2 In the **Model Builder** window, expand the **Solution 1 (sol1)** node, then click **Time-Dependent Solver 1**.
- 3 In the **Settings** window for **Time-Dependent Solver**, click to expand the **Time Stepping** section.
- 4 In the **Event tolerance** text field, type 0.001.

- 5 In the **Model Builder** window, expand the **Study 1 > Solver Configurations > Solution 1 (sol1) > Time-Dependent Solver 1 > Segregated 1** node, then click **Battery Current Distribution**.
- 6 In the **Settings** window for **Segregated Step**, click to expand the **Method and Termination** section.
- 7 From the **Nonlinear method** list, choose **Automatic (Newton)**.
- 8 Right-click **Study 1 > Solver Configurations > Solution 1 (sol1) > Time-Dependent Solver 1 > Segregated 1 > Battery Current Distribution** and choose **Move Up**.
- 9 In the **Model Builder** window, click **Study 1**.
- 10 In the **Settings** window for **Study**, locate the **Study Settings** section.
- 11 Clear the **Generate default plots** checkbox.
- 12 In the **Study** toolbar, click  **Compute**.

## RESULTS

### *Probe Plot Group 1*

- 1 In the **Model Builder** window, expand the **Results > Probe Plot Group 1** node, then click **Probe Plot Group 1**.
- 2 In the **Settings** window for **ID Plot Group**, click to expand the **Title** section.
- 3 From the **Title type** list, choose **Manual**.
- 4 In the **Title** text area, type **Cell potential and load**.
- 5 Locate the **Plot Settings** section. Select the **Two y-axes** checkbox.
- 6 Select the **y-axis label** checkbox. In the associated text field, type **Cell potential (V)**.
- 7 Select the **Secondary y-axis label** checkbox. In the associated text field, type **Battery load (1)**.
- 8 Locate the **Legend** section. From the **Position** list, choose **Lower right**.

### *Cell Potential (V)*

- 1 In the **Model Builder** window, under **Results > Probe Plot Group 1** click **Probe Table Graph 1**.
- 2 In the **Settings** window for **Table Graph**, type **Cell Potential (V)** in the **Label** text field.
- 3 Locate the **Data** section. In the **Columns** list box, select **Applied voltage (V)**.
- 4 Click to expand the **Legends** section. Find the **Include** subsection. Select the **Label** checkbox.

5 Clear the **Headers** checkbox.

*Battery load (C-rate)*

- 1 Right-click **Cell Potential (V)** and choose **Duplicate**.
- 2 In the **Settings** window for **Table Graph**, locate the **Data** section.
- 3 In the **Columns** list box, select **Applied current (A)**.
- 4 Locate the **y-Axis** section. Select the **Plot on secondary y-axis** checkbox.
- 5 In the **Label** text field, type Battery load (C-rate).
- 6 In the **Probe Plot Group 1** toolbar, click  **Plot**.

*Probe Plot Group 2*

- 1 In the **Model Builder** window, expand the **Results > Probe Plot Group 2** node, then click **Probe Plot Group 2**.
- 2 In the **Settings** window for **ID Plot Group**, locate the **Title** section.
- 3 From the **Title type** list, choose **Manual**.
- 4 In the **Title** text area, type Temperature change and load.
- 5 Locate the **Plot Settings** section. Select the **Two y-axes** checkbox.
- 6 Select the **y-axis label** checkbox. In the associated text field, type  $\Delta T$  (K).
- 7 Select the **Secondary y-axis label** checkbox. In the associated text field, type Battery load (1).
- 8 Locate the **Legend** section. From the **Position** list, choose **Lower right**.

*Probe Table Graph 1*

- 1 In the **Model Builder** window, click **Probe Table Graph 1**.
- 2 In the **Settings** window for **Table Graph**, locate the **Data** section.
- 3 In the **Columns** list, choose **T-T\_inlet (K)**, **Domain Probe 1**, **T-T\_inlet (K)**, **Domain Probe 2**, and **T-T\_inlet (K)**, **Domain Probe 3**.
- 4 Locate the **Legends** section. From the **Legends** list, choose **Manual**.
- 5 In the table, enter the following settings:



<b>Legends</b>
Mean
Max
Min

- 6 In the **Probe Plot Group 2** toolbar, click  **Plot**.

### *Battery load (C-rate)*



- 1 In the **Model Builder** window, right-click **Probe Plot Group 2** and choose **Table Graph**.
- 2 In the **Settings** window for **Table Graph**, type **Battery Load (C-rate)** in the **Label** text field.
- 3 Locate the **Data** section. From the **Plot columns** list, choose **Manual**.
- 4 In the **Columns** list box, select **Applied current (A)**.
- 5 Locate the **y-Axis** section. Select the **Plot on secondary y-axis** checkbox.
- 6 Locate the **Legends** section. Select the **Show legends** checkbox.
- 7 Find the **Include** subsection. Select the **Label** checkbox.
- 8 Clear the **Headers** checkbox.

### *Temperature*

- 1 In the **Model Builder** window, under **Results > Probe Plot Group 2** click **Probe Table Graph 1**.
- 2 In the **Settings** window for **Table Graph**, type **Temperature** in the **Label** text field.
- 3 In the **Probe Plot Group 2** toolbar, click  **Plot**.
- 4 Click the  **Zoom Extents** button in the **Graphics** toolbar.

## **DEFINITIONS (COMP2)**

### *Battery Surface*

- 1 In the **Definitions** toolbar, click  **Adjacent**.
- 2 In the **Settings** window for **Adjacent**, locate the **Input Entities** section.
- 3 Under **Input selections**, click  **Add**.
- 4 In the **Add** dialog, in the **Input selections** list, choose **Active Battery Material**, **Battery Connector**, and **Mandrel**.
- 5 Click **OK**.
- 6 In the **Settings** window for **Adjacent**, locate the **Output Entities** section.
- 7 Select the **Interior boundaries** checkbox.
- 8 In the **Label** text field, type **Battery Surface**.



## **RESULTS**

### *Study 1/Solution 1 (9) (sol1)*

- 1 In the **Results** toolbar, click  **More Datasets** and choose **Solution**.
- 2 In the **Settings** window for **Solution**, locate the **Solution** section.

- 3 From the **Component** list, choose **Component 2 (comp2)**.

#### *Selection*

- 1 In the **Results** toolbar, click  **Attributes** and choose **Selection**.
- 2 In the **Settings** window for **Selection**, locate the **Geometric Entity Selection** section.
- 3 From the **Geometric entity level** list, choose **Boundary**.
- 4 From the **Selection** list, choose **Battery Surface**.
- 5 Click the  **Transparency** button in the **Graphics** toolbar.

#### *Temperature and flow*

- 1 In the **Results** toolbar, click  **3D Plot Group**.
- 2 In the **Settings** window for **3D Plot Group**, type **Temperature and flow** in the **Label** text field.
- 3 Locate the **Plot Settings** section. Clear the **Plot dataset edges** checkbox.
- 4 Locate the **Data** section. From the **Dataset** list, choose **None**.

#### *Surface 1*



- 1 Right-click **Temperature and flow** and choose **Surface**.
- 2 In the **Settings** window for **Surface**, locate the **Data** section.
- 3 From the **Dataset** list, choose **Study 1/Solution 1 (9) (sol1)**.
- 4 From the **Time (s)** list, choose **1500.4**.
- 5 Locate the **Expression** section. In the **Expression** text field, type **T**.
- 6 Locate the **Coloring and Style** section. From the **Color table** list, choose **Thermal**.
- 7 In the **Temperature and flow** toolbar, click  **Plot**.

#### *Streamline 1*

- 1 In the **Model Builder** window, right-click **Temperature and flow** and choose **Streamline**.
- 2 In the **Settings** window for **Streamline**, locate the **Data** section.
- 3 From the **Dataset** list, choose **Study 1/Solution 1 (9) (sol1)**.
- 4 From the **Time (s)** list, choose **1500.4**.
- 5 Click **Replace Expression** in the upper-right corner of the **Expression** section. From the menu, choose **Component 2 (comp2) > Laminar Flow > Velocity and pressure > u,v,w - Velocity field**.
- 6 Locate the **Streamline Positioning** section. From the **Positioning** list, choose **On selected entities**.
- 7 Locate the **Selection** section. From the **Selection** list, choose **Inlet**.

- 8 Locate the **Coloring and Style** section. Find the **Line style** subsection. From the **Type** list, choose **Ribbon**.

#### *Color Expression 1*

- 1 Right-click **Streamline 1** and choose **Color Expression**.
- 2 In the **Settings** window for **Color Expression**, click **Replace Expression** in the upper-right corner of the **Expression** section. From the menu, choose **Component 2 (comp2) > Laminar Flow > Velocity and pressure > spf.U - Velocity magnitude - m/s**.
- 3 In the **Temperature and flow** toolbar, click  **Plot**.
- 4 Click the  **Zoom Extents** button in the **Graphics** toolbar.

#### *Load cycle*

- 1 In the **Model Builder** window, under **Results** right-click **Probe Plot Group 1** and choose **Rename**.
- 2 In the **Rename ID Plot Group** dialog, type `Load cycle` in the **New label** text field.
- 3 Click **OK**.

#### *Temperature vs. Time*

- 1 In the **Model Builder** window, right-click **Probe Plot Group 2** and choose **Rename**.
- 2 In the **Rename ID Plot Group** dialog, type `Temperature vs. Time` in the **New label** text field.
- 3 Click **OK**.

In order to simulate a bidirectionally coupled approach for flow and temperature computation, a new study can be set up as above, but with **Laminar Flow** being solved for in the **Time Dependent** study step. A plot comparing the bidirectionally and unidirectionally coupled approaches can be created using **Join** datasets to evaluate the difference in battery temperature and airflow streamlines between the two solutions.

For the scenario studied in this model, the solutions obtained with the bidirectionally and unidirectionally coupled approaches are relatively close, while the unidirectionally coupled approach is much faster to solve.