



Model created in COMSOL Multiphysics 6.4

# Thermal Distribution in a Pack of Cylindrical Batteries

## *Introduction*

---

This example demonstrates how to model the temperature distribution in a battery pack during a 4C discharge. The pack is constructed by first coupling two cylindrical batteries in parallel. Six parallel-connected pairs are then connected in series to create the full pack — a configuration also called 6s2p. This configuration for the lithium-ion battery pack is quite common in portable devices like skateboards, toys, drones, and medical equipment. The symmetry of the problem is used twice so that only the temperature distribution for three batteries needs to be solved for.

A Battery Pack interface is used to generate the appropriate heat sources, which is then coupled to one Heat Transfer interface in a 3D geometry.

For a detailed description of the underlying battery model, see the [Parameter Estimation of a Time-Dependent Lumped Battery Model](#) tutorial.

## *Model Definition*

---

[Figure 1](#) shows the model geometry. Three 21,700 battery cylinders (21 mm in diameter, 70 mm high) are placed adjacent to each other. Small electrically conducting strips of aluminum are located at the top and bottom of the cylinders according to the 6s2p configuration. The whole pack is assumed to be wrapped in plastic, forming a domain filled with air. Assuming a nominal charge capacity of 4 Ah for each cell and nominal voltage of 3.7 V, the battery pack has a total nominal capacity of approximately 178 Wh.

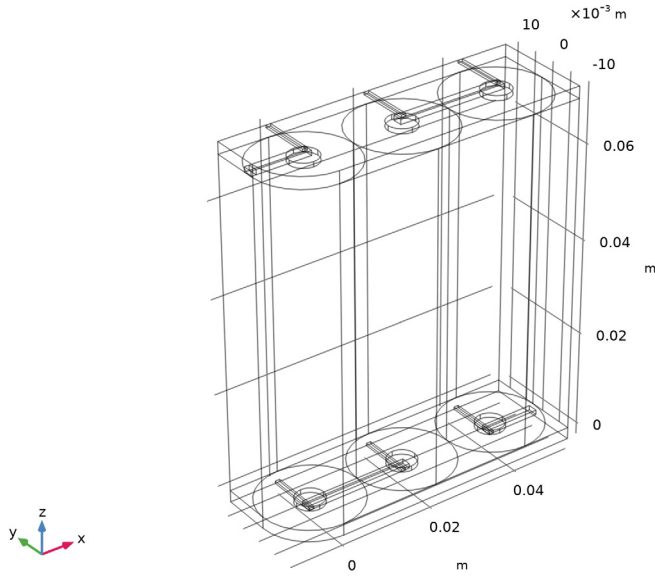

*Figure 1: Model geometry.*

The Battery Pack interface is used to define separate (lumped) battery models for each battery cylinder, with temperature-dependent ohmic, exchange current and diffusion time-constant parameters according to Arrhenius expressions. The Battery Pack interface also models the electric potential in the electric conductors use to connect the batteries.

The temperature profile is modeled using a Heat Transfer interface, where the heat sources stemming from the battery models, and the joule heating in the electric conductors, are included by the use of an Electrochemical Heating multiphysics node. The convection in the air-filled domain enclosing the batteries is neglected, assuming quiescent conditions. The outer boundaries of the pack are cooled using a convective cooling condition. Symmetry (no flux) conditions are used for the interior flat symmetry boundaries facing the rest of the pack.

Anisotropic heat conductivities are used in each battery by the use of the Battery Layers node, which makes use of individual cylindrical coordinate systems for each battery cylinder, with generally lower heat conductivities in the through-layer (radial) direction compared to the in-layer (angular and  $z$ ) directions — a result of the spirally wound metal foils in the jelly roll design of the batteries.

The pack is discharged from 100% to 20% state-of-charge (SOC) using a 4C rate for 12 minutes.

## Results and Discussion

Figure 2 shows the temperature distribution in the pack at the end of the simulation, where the solution data has been mirrored twice to illustrate the temperature of the full 6s2p pack. The innermost parts of the pack experience a temperature about 2°C higher than the outermost parts.

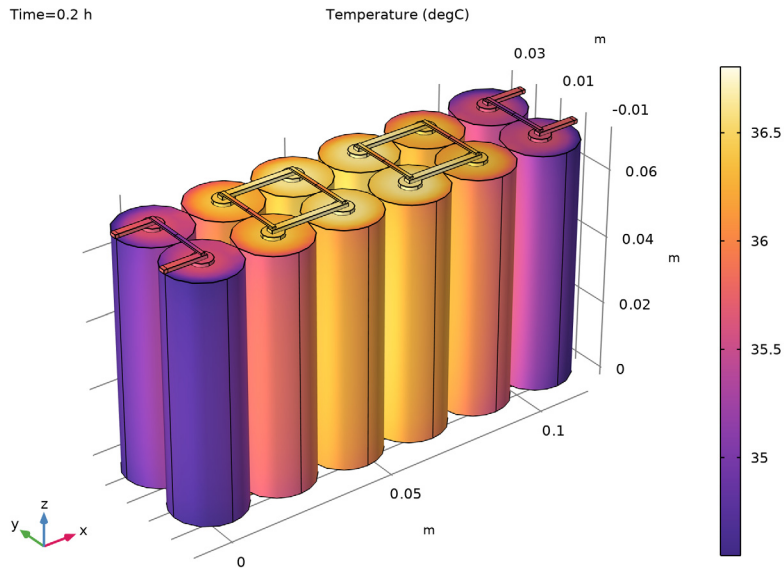

Figure 2: Temperature plot at  $t = 0.2$  h.

Figure 3 shows a plot of the individual cell voltages during the discharge. The outermost cell (Cell 1) exhibits a slightly lower discharge voltage, a result of the ohmic drop and exchange current being slightly lower, and the diffusion time constant slightly higher, for the lower temperature, but the effect is small. The corresponding temperatures are shown in Figure 4.

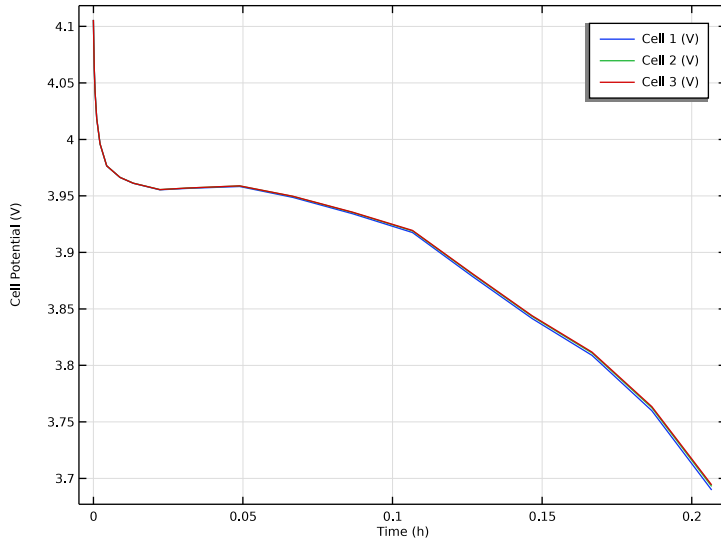

Figure 3: Cell voltages versus time.

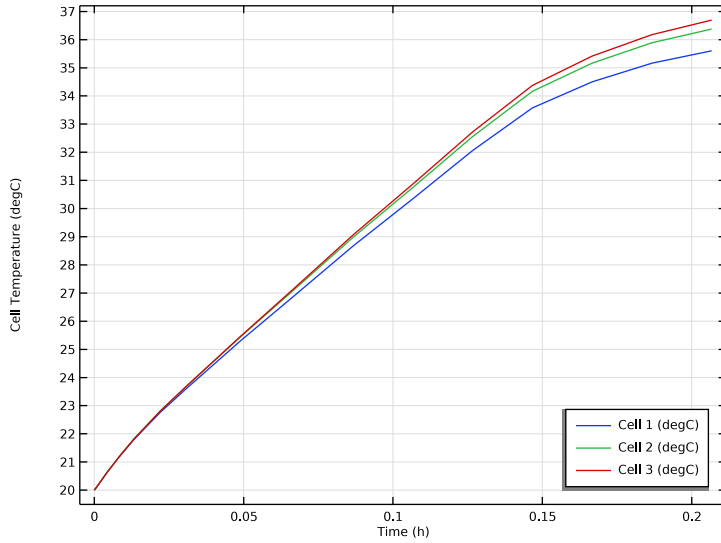

Figure 4: Average cell temperatures versus time.

---

**Application Library path:** Battery\_Design\_Module/Thermal\_Management/  
battery\_pack\_6s2p

---

### *Modeling Instructions*



---

From the **File** menu, choose **New**.

#### **NEW**

In the **New** window, click  **Model Wizard**.

#### **MODEL WIZARD**

- 1 In the **Model Wizard** window, Start with adding a 3D space dimension along with a Heat Transfer in Fluids and a Battery Pack interface.
- 2 click  **3D**.
- 3 In the **Select Physics** tree, select **Electrochemistry > Batteries > Battery Pack (bp)**.
- 4 Click **Add**.
- 5 In the **Select Physics** tree, select **Heat Transfer > Heat Transfer in Fluids (ht)**.
- 6 Click **Add**.
- 7 Click  **Study**.
- 8 In the **Select Study** tree, select **General Studies > Time Dependent**.
- 9 Click  **Done**.

#### **DEFINITIONS**

Add an analytical function to account for the temperature dependent activation energy using the Arrhenius relation.

##### *Analytic 1 (an1)*

- 1 In the **Definitions** toolbar, click  **Analytic**.
- 2 In the **Settings** window for **Analytic**, type Arrh in the **Function name** text field.
- 3 Locate the **Definition** section. In the **Expression** text field, type  $\exp(Ea/R\_const*(1/Temp - 1/T0))$ .
- 4 In the **Arguments** text field, type Ea, Temp.



5 Locate the **Units** section. In the table, enter the following settings:

Argument	Unit
Ea	J/mol
Temp	K

6 In the **Function** text field, type 1.

*E\_OCP*

Next add interpolation functions to define the SOC dependent equilibrium potential and its temperature dependence.



- 1 In the **Definitions** toolbar, click  **Interpolation**.
- 2 In the **Settings** window for **Interpolation**, type E\_OCP in the **Label** text field.
- 3 Locate the **Definition** section. From the **Data source** list, choose **File**.
- 4 In the **Filename** text field, type battery\_pack\_6s2p\_E\_OCP\_data.txt.
- 5 Click  **Import**.
- 6 Locate the **Units** section. In the **Argument** table, enter the following settings:

Argument	Unit
t	1

7 In the **Function** table, enter the following settings:

Function	Unit
intI	V

*dEdT*

- 1 In the **Definitions** toolbar, click  **Interpolation**.
- 2 In the **Settings** window for **Interpolation**, type dEdT in the **Label** text field.
- 3 Locate the **Definition** section. From the **Data source** list, choose **File**.
- 4 In the **Filename** text field, type battery\_pack\_6s2p\_dEdT\_data.txt.
- 5 Click  **Import**.
- 6 Locate the **Units** section. In the **Argument** table, enter the following settings:



Argument	Unit
t	1

7 In the **Function** table, enter the following settings:

Function	Unit
int2	V/K

## GEOMETRY I

The model geometry is available as a parameterized geometry sequence in a separate MPH file. If you want to build it from scratch, follow the instructions in the section [Appendix — Geometry Modeling Instructions](#). Otherwise load it from file with the following steps.

- 1 In the **Geometry** toolbar, click **Insert Sequence** and choose **Insert Sequence**.
- 2 Browse to the model's Application Libraries folder and double-click the file `battery_pack_6s2p_geom_sequence.mph`.
- 3 In the **Geometry** toolbar, click  **Build All**.
- 4 Click the  **Transparency** button in the **Graphics** toolbar.  
Disable the analysis of the geometry as the remaining small geometric details can be kept.
- 5 In the **Model Builder** window, click **Geometry I**.
- 6 In the **Settings** window for **Geometry**, locate the **Cleanup** section.
- 7 Clear the **Automatic detection of small details** checkbox.
- 8 Click the  **Zoom Extents** button in the **Graphics** toolbar.



## GLOBAL DEFINITIONS

### *Geometry Parameters*

- 1 In the **Model Builder** window, under **Global Definitions** click **Parameters I**.
- 2 In the **Settings** window for **Parameters**, type Geometry Parameters in the **Label** text field.

### *Battery Parameters*

Add the parameter file required for setting up the physics of the lumped battery and heat transfer interfaces.



- 1 In the **Home** toolbar, click  **Parameters** and choose **Add > Parameters**.
- 2 In the **Settings** window for **Parameters**, type Battery Parameters in the **Label** text field.
- 3 Locate the **Parameters** section. Click  **Load from File**.

- 4 Browse to the model's Application Libraries folder and double-click the file `battery_pack_6s2p_parameters.txt`.

## MATERIALS

Next, add and define the materials in the different domains: air to the region surrounding the batteries and aluminum to the current collectors.

### ADD MATERIAL

- 1 In the **Materials** toolbar, click  **Add Material** to open the **Add Material** window.
- 2 Go to the **Add Material** window.
- 3 In the tree, select **Built-in > Air**.
- 4 Click the **Add to Component** button in the window toolbar.
- 5 In the tree, select **Built-in > Aluminum**.
- 6 Click the **Add to Component** button in the window toolbar.
- 7 In the **Materials** toolbar, click  **Add Material** to close the **Add Material** window.

## MATERIALS

### *Air (mat1)*

- 1 In the **Settings** window for **Material**, locate the **Geometric Entity Selection** section.
- 2 From the **Selection** list, choose **Air Domain**.

### *Aluminum (mat2)*

- 1 In the **Model Builder** window, click **Aluminum (mat2)**.
- 2 In the **Settings** window for **Material**, locate the **Geometric Entity Selection** section.
- 3 From the **Selection** list, choose **Conductors**.

## BATTERY PACK (BP)

Now define the batteries of the pack.

- 1 In the **Model Builder** window, under **Component 1 (comp1)** click **Battery Pack (bp)**.
- 2 In the **Settings** window for **Battery Pack**, locate the **Domain Selection** section.
- 3 From the **Selection** list, choose **Batteries and Conductors**.

### *Batteries*

- 1 In the **Model Builder** window, under **Component 1 (comp1) > Battery Pack (bp)** click **Batteries**.
- 2 In the **Settings** window for **Batteries**, locate the **Domain Selection** section.

- 3 From the **Selection** list, choose **Batteries**.
- 4 Locate the **Initial Capacity** section. In the  $Q_{\text{cell},0}$  text field, type  $Q_{\text{cell}}$ .
- 5 Locate the **Initial Cell Charge Distribution** section. In the  $\text{SOC}_{\text{cell},0}$  text field, type 1.

#### *Cell Equilibrium Potential I*

- 1 In the **Model Builder** window, click **Cell Equilibrium Potential I**.
- 2 In the **Settings** window for **Cell Equilibrium Potential**, locate the **Open Circuit Voltage** section.
- 3 From the **Open circuit voltage input** list, choose **From definitions**.
- 4 From the  $E_{\text{OCV,ref}}$  list, choose **E\_OCP (int1)**.
- 5 From the  $dE_{\text{OCV}}/dT$  list, choose **dEdT (int2)**.

#### *Voltage Losses I*

- 1 In the **Model Builder** window, click **Voltage Losses I**.
- 2 In the **Settings** window for **Voltage Losses**, locate the **Ohmic Overpotential** section.
- 3 In the  $\eta_{\text{IR},1\text{C}}$  text field, type  $\text{eta}_{1\text{C}}*\text{Arrh}(\text{Ea}_{\text{eta}1\text{C}}, \text{bp.T}_{\text{cell}})$ .
- 4 Locate the **Activation Overpotential** section. In the  $J_0$  text field, type  $J0_0*\text{Arrh}(\text{Ea}_{J0}, \text{bp.T}_{\text{cell}})$ .
- 5 Locate the **Concentration Overpotential** section. Select the **Include concentration overpotential** checkbox.
- 6 In the  $\tau$  text field, type  $\text{tau}_0*\text{Arrh}(\text{Ea}_{\text{Tau}}, \text{bp.T}_{\text{cell}})$ .

#### *Current Conductors*

- 1 In the **Model Builder** window, under **Component 1 (comp1) > Battery Pack (bp)** click **Current Conductors**.
- 2 In the **Settings** window for **Current Conductors**, locate the **Domain Selection** section.
- 3 From the **Selection** list, choose **Conductors**.

#### *Ground I*

- 1 In the **Physics** toolbar, click  **Attributes** and choose **Ground**.
- 2 Select Boundary 1 only.

#### *Current Conductors*

In the **Model Builder** window, click **Current Conductors**.

#### *Current I*

- 1 In the **Physics** toolbar, click  **Attributes** and choose **Current**.
- 2 Select Boundary 167 only.

- 3 In the **Settings** window for **Current**, locate the **Electrode Current** section.
- 4 In the  $I_{s,total}$  text field, type  $-I_{1C}*C\_rate$ .

#### *Negative Connectors*

- 1 In the **Model Builder** window, under **Component 1 (comp1) > Battery Pack (bp)** click **Negative Connectors**.
- 2 Select Boundaries 34, 79, and 128 only.

#### *Positive Connectors*

- 1 In the **Model Builder** window, click **Positive Connectors**.
- 2 Select Boundaries 31, 82, and 125 only.

### **HEAT TRANSFER IN FLUIDS (HT)**

Now define the heat transfer in the battery pack.

#### *Initial Values 1*

- 1 In the **Model Builder** window, under **Component 1 (comp1) > Heat Transfer in Fluids (ht)** click **Initial Values 1**.
- 2 In the **Settings** window for **Initial Values**, locate the **Initial Values** section.
- 3 In the  $T$  text field, type  $T\_init$ .

#### *Heat Flux 1*

- 1 In the **Physics** toolbar, click  **Boundaries** and choose **Heat Flux**.
- 2 In the **Settings** window for **Heat Flux**, locate the **Boundary Selection** section.
- 3 From the **Selection** list, choose **Heat Flux Boundaries**.
- 4 Locate the **Heat Flux** section. From the **Flux type** list, choose **Convective heat flux**.
- 5 In the  $h$  text field, type  $ht$ .
- 6 In the  $T_{ext}$  text field, type  $T\_init$ .

#### *Battery Layers 1*

- 1 In the **Physics** toolbar, click  **Domains** and choose **Battery Layers**.
- 2 In the **Settings** window for **Battery Layers**, locate the **Domain Selection** section.
- 3 From the **Selection** list, choose **Batteries**.

Due to the winding of the layers, the thermal conductivities in the battery domains exhibit anisotropic properties, with higher conductivity values in the in-layer direction compared to the through-layer (radial) direction.

- 4 Locate the **Battery Layers** section. From the **Layer configuration** list, choose **Spirally wound (cylindrical)**.
- 5 In the  $k_{t1}$  text field, type `kT_batt_t1`.
- 6 In the  $k_{i1}$  text field, type `kT_batt_i1`.
- 7 In the  $\rho_{\text{eff}}$  text field, type `rho_batt`.
- 8 In the  $C_{p,\text{eff}}$  text field, type `Cp_batt`.

#### *Solid 1*

- 1 In the **Physics** toolbar, click  **Domains** and choose **Solid**.
- 2 In the **Settings** window for **Solid**, locate the **Domain Selection** section.
- 3 From the **Selection** list, choose **Conductors**.

### **MULTIPHYSICS**

Add a two-way coupling between the **Battery Pack** and the **Heat Transfer** interfaces for the heat sources and the temperature by adding an **Electrochemical Heating** multiphysics node.

#### *Electrochemical Heating 1 (ech1)*

In the **Physics** toolbar, click  **Multiphysics Couplings** and choose **Domain > Electrochemical Heating**.

### **MESH 1**

#### *Swept 1*

- 1 In the **Mesh** toolbar, click  **Swept**.
- 2 In the **Settings** window for **Swept**, locate the **Domain Selection** section.
- 3 From the **Geometric entity level** list, choose **Domain**.
- 4 From the **Selection** list, choose **Mesh Sweep Domains**.
- 5 Locate the **Mesh Generation** section. From the **Elements** list, choose **Prisms**.

#### *Free Tetrahedral 1*

- 1 In the **Mesh** toolbar, click  **Free Tetrahedral**.

2 In the **Model Builder** window, right-click **Mesh 1** and choose **Build All**.

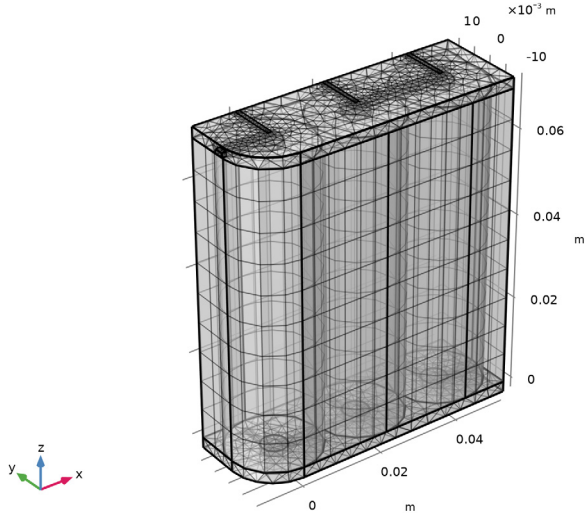

### DEFINITIONS (COMPI)

Adding probes for temperatures and cell potentials allows for visualizing results while solving. The **Battery Pack** interface defines cell potential variables named  $bp.E_{cell\_X}$  and  $bp.T_{cell\_X}$  for the individual cell voltages and volume-averaged cell temperatures, where X represents the cell number. Add probes for these variables as follows:

#### Temperature Cell 1

- 1 In the **Definitions** toolbar, click  **Probes** and choose **Global Variable Probe**.
- 2 In the **Settings** window for **Global Variable Probe**, type Temp1 in the **Variable name** text field.
- 3 In the **Label** text field, type Temperature Cell 1.
- 4 Locate the **Expression** section. In the **Expression** text field, type  $bp.T_{cell\_1}$ .
- 5 In the **Table and plot unit** field, type degC.
- 6 Select the **Description** checkbox. In the associated text field, type Cell 1.
- 7 Click to expand the **Table and Window Settings** section. Click **+ Add Table**.
- 8 From the **Plot window** list, choose **New window**.
- 9 Click **+ Add Plot Window**.

### *Temperature Cell 2*

- 1 Right-click **Temperature Cell 1** and choose **Duplicate**.
- 2 In the **Settings** window for **Global Variable Probe**, type Temperature Cell 2 in the **Label** text field.
- 3 In the **Variable name** text field, type Temp2.
- 4 Locate the **Expression** section. In the **Expression** text field, type  $bp.T\_cell\_2$ .
- 5 In the **Description** text field, type Cell 2.

### *Temperature Cell 3*

- 1 Right-click **Temperature Cell 2** and choose **Duplicate**.
- 2 In the **Settings** window for **Global Variable Probe**, type Temperature Cell 3 in the **Label** text field.
- 3 In the **Variable name** text field, type Temp3.
- 4 Locate the **Expression** section. In the **Expression** text field, type  $bp.T\_cell\_3$ .
- 5 In the **Description** text field, type Cell 3.

### *Cell Potential 1*

- 1 Right-click **Temperature Cell 3** and choose **Duplicate**.
- 2 In the **Settings** window for **Global Variable Probe**, type Cell Potential 1 in the **Label** text field.
- 3 In the **Variable name** text field, type Ecell1.
- 4 Locate the **Expression** section. In the **Expression** text field, type  $bp.E\_cell\_1$ .
- 5 In the **Description** text field, type Cell 1.
- 6 Locate the **Table and Window Settings** section. Click **+ Add Table**.
- 7 From the **Plot window** list, choose **New window**.
- 8 Click **+ Add Plot Window**.

### *Cell Potential 2*

- 1 Right-click **Cell Potential 1** and choose **Duplicate**.
- 2 In the **Settings** window for **Global Variable Probe**, type Cell Potential 2 in the **Label** text field.
- 3 In the **Variable name** text field, type Ecell2.
- 4 Locate the **Expression** section. In the **Expression** text field, type  $bp.E\_cell\_2$ .
- 5 In the **Description** text field, type Cell 2.

### Cell Potential 3

- 1 Right-click **Cell Potential 2** and choose **Duplicate**.
- 2 In the **Settings** window for **Global Variable Probe**, type Cell Potential 3 in the **Label** text field.
- 3 In the **Variable name** text field, type Ecell3.
- 4 Locate the **Expression** section. In the **Expression** text field, type  $bp.E\_cell\_3$ .
- 5 In the **Description** text field, type Cell 3.

## STUDY 1

### Step 1: Time Dependent

- 1 In the **Model Builder** window, under **Study 1** click **Step 1: Time Dependent**.
- 2 In the **Settings** window for **Time Dependent**, locate the **Study Settings** section.
- 3 From the **Time unit** list, choose **h**.
- 4 In the **Output times** text field, type  $0\ 0.8/C\_rate$ .
- 5 In the **Study** toolbar, click  **Compute**.

## RESULTS

Add a dataset with a selection and mirror it twice in order to visualize the temperature of the full 6s2p configuration.

### Study 1/Solution 1 (3) (sol1)

In the **Results** toolbar, click  **More Datasets** and choose **Solution**.

### Selection

- 1 In the **Results** toolbar, click  **Attributes** and choose **Selection**.
- 2 In the **Settings** window for **Selection**, locate the **Geometric Entity Selection** section.
- 3 From the **Geometric entity level** list, choose **Domain**.
- 4 From the **Selection** list, choose **Batteries and Conductors**.

### Mirror 3D 1

- 1 In the **Results** toolbar, click  **More Datasets** and choose **Mirror 3D**.
- 2 In the **Settings** window for **Mirror 3D**, locate the **Data** section.
- 3 From the **Dataset** list, choose **Study 1/Solution 1 (3) (sol1)**.
- 4 Locate the **Plane Data** section. In the **X-coordinate** text field, type  $2.5*(d\_batt)$ .

### Mirror 3D 2

- 1 Right-click **Mirror 3D 1** and choose **Duplicate**.

- 2 In the **Settings** window for **Mirror 3D**, locate the **Data** section.
- 3 From the **Dataset** list, choose **Mirror 3D 1**.
- 4 Locate the **Plane Data** section. From the **Plane** list, choose **zx-planes**.
- 5 In the **y-coordinate** text field, type `d_batt/2`.
- 6 Click  **Plot**.

#### *Cell Temperatures vs. Time*

- 1 In the **Model Builder** window, expand the **Results > Probe Plot Group 1** node, then click **Probe Plot Group 1**.
- 2 In the **Settings** window for **ID Plot Group**, type `Cell Temperatures vs. Time` in the **Label** text field.
- 3 Locate the **Plot Settings** section. Select the **x-axis label** checkbox.
- 4 Select the **y-axis label** checkbox. In the associated text field, type `Cell Temperature (degC)`.
- 5 Locate the **Legend** section. From the **Position** list, choose **Lower right**.
- 6 In the **Cell Temperatures vs. Time** toolbar, click  **Plot**.

#### *Cell Potential vs. Time*



- 1 In the **Model Builder** window, under **Results** click **Probe Plot Group 2**.
- 2 In the **Settings** window for **ID Plot Group**, type `Cell Potential vs. Time` in the **Label** text field.
- 3 Locate the **Plot Settings** section. Select the **x-axis label** checkbox.
- 4 Select the **y-axis label** checkbox. In the associated text field, type `Cell Potential (V)`.
- 5 In the **Cell Potential vs. Time** toolbar, click  **Plot**.

#### *Temperature*

- 1 In the **Results** toolbar, click  **3D Plot Group**.
- 2 In the **Settings** window for **3D Plot Group**, locate the **Data** section.
- 3 From the **Dataset** list, choose **Mirror 3D 2**.
- 4 In the **Label** text field, type `Temperature`.

#### *Surface 1*

- 1 Right-click **Temperature** and choose **Surface**.
- 2 In the **Settings** window for **Surface**, click **Replace Expression** in the upper-right corner of the **Expression** section. From the menu, choose **Component 1 (comp1) > Heat Transfer in Fluids > Temperature > T - Temperature - K**.

- 3 Locate the **Expression** section. In the **Unit** field, type degC.
- 4 Locate the **Coloring and Style** section. From the **Color table** list, choose **HeatCameraLight**.
- 5 In the **Temperature** toolbar, click  **Plot**.
- 6 Click the  **Zoom Extents** button in the **Graphics** toolbar.

*Electric Potential (bp)*

In the **Model Builder** window, under **Results** right-click **Electric Potential (bp)** and choose **Delete**.

## *Appendix — Geometry Modeling Instructions*



---

From the **File** menu, choose **New**.

### **NEW**

In the **New** window, click  **Model Wizard**.

### **MODEL WIZARD**

- 1 In the **Model Wizard** window, click  **3D**.
- 2 Click  **Done**.

### **GLOBAL DEFINITIONS**

*Geometry Parameters*

- 1 In the **Model Builder** window, under **Global Definitions** click **Parameters I**.
- 2 In the **Settings** window for **Parameters**, type Geometry Parameters in the **Label** text field.
- 3 Locate the **Parameters** section. Click  **Load from File**.
- 4 Browse to the model's Application Libraries folder and double-click the file battery\_pack\_6s2p\_geom\_sequence\_parameters.txt.

### **GEOMETRY I**



*Cylinder 1 (cyl1)*

- 1 In the **Geometry** toolbar, click  **Cylinder**.
- 2 In the **Settings** window for **Cylinder**, locate the **Size and Shape** section.
- 3 In the **Radius** text field, type r\_batt.
- 4 In the **Height** text field, type h\_batt.





### *Cylinder 2 (cyl2)*

- 1 Right-click **Cylinder 1 (cyl1)** and choose **Duplicate**.
- 2 In the **Settings** window for **Cylinder**, locate the **Size and Shape** section.
- 3 In the **Radius** text field, type  $r\_term$ .
- 4 In the **Height** text field, type  $h\_term$ .
- 5 Locate the **Position** section. In the **z** text field, type  $-h\_term$ .

### *Array 1 (arr1)*



- 1 In the **Geometry** toolbar, click  **Transforms** and choose **Array**.
- 2 In the **Settings** window for **Array**, locate the **Input** section.
- 3 Click the  **Paste Selection** button for **Input objects**.
- 4 In the **Paste Selection** dialog, type `cy12` in the **Selection** text field.
- 5 Click **OK**.
- 6 In the **Settings** window for **Array**, click to collapse the **Displacement** section.
- 7 Locate the **Size** section. In the **z size** text field, type `2`.
- 8 Click to expand the **Displacement** section. In the **z** text field, type  $h\_batt+h\_term$ .

### *Array 2 (arr2)*

- 1 Right-click **Array 1 (arr1)** and choose **Duplicate**.
- 2 In the **Settings** window for **Array**, locate the **Input** section.
- 3 Click to select the  **Activate Selection** toggle button for **Input objects**.
- 4 Click the  **Paste Selection** button for **Input objects**.
- 5 In the **Paste Selection** dialog, type `cy11` in the **Selection** text field.
- 6 Click **OK**.
- 7 In the **Settings** window for **Array**, locate the **Input** section.
- 8 Click the  **Paste Selection** button for **Input objects**.
- 9 In the **Paste Selection** dialog, type `arr1(1,1,1)` in the **Selection** text field.
- 10 Click **OK**.
- 11 In the **Settings** window for **Array**, locate the **Input** section.
- 12 Click the  **Paste Selection** button for **Input objects**.
- 13 In the **Paste Selection** dialog, type `arr1(1,1,2)` in the **Selection** text field.
- 14 Click **OK**.
- 15 In the **Settings** window for **Array**, locate the **Size** section.

- 16 In the **x size** text field, type 3.
- 17 Locate the **Displacement** section. In the **x** text field, type  $d_{batt}$ .
- 18 In the **z** text field, type 0.
- 19 Click  **Build Selected**.

*Block 1 (blk1)*

- 1 In the **Geometry** toolbar, click  **Block**.
- 2 In the **Settings** window for **Block**, locate the **Size and Shape** section.
- 3 In the **Width** text field, type  $d_{batt}+d_{sc}$ .
- 4 In the **Depth** text field, type  $d_{sc}$ .
- 5 In the **Height** text field, type  $h_{sc}$ .
- 6 Locate the **Position** section. In the **x** text field, type  $-d_{sc}/2$ .
- 7 In the **y** text field, type  $-d_{sc}/2$ .
- 8 In the **z** text field, type  $-h_{sc}-h_{term}$ .
- 9 Click  **Build Selected**.

*Block 2 (blk2)*

- 1 In the **Geometry** toolbar, click  **Block**.
- 2 In the **Settings** window for **Block**, locate the **Size and Shape** section.
- 3 In the **Width** text field, type  $(d_{batt}+d_{sc})/2$ .
- 4 In the **Depth** text field, type  $d_{sc}$ .
- 5 In the **Height** text field, type  $h_{sc}$ .
- 6 Locate the **Position** section. In the **x** text field, type  $-d_{sc}/2+(d_{batt})*2$ .
- 7 In the **y** text field, type  $-d_{sc}/2$ .
- 8 In the **z** text field, type  $-h_{term}-h_{sc}$ .

*Block 3 (blk3)*





- 1 Right-click **Block 2 (blk2)** and choose **Duplicate**.
- 2 In the **Settings** window for **Block**, locate the **Size and Shape** section.
- 3 In the **Width** text field, type  $(d_{batt})/2+d_{sc}$ .
- 4 Locate the **Position** section. In the **x** text field, type  $-d_{sc}/2-d_{batt}/2$ .
- 5 In the **z** text field, type  $h_{batt}+h_{term}$ .

*Block 4 (blk4)*



- 1 Right-click **Block 3 (blk3)** and choose **Duplicate**.

- 2 In the **Settings** window for **Block**, locate the **Size and Shape** section.
- 3 In the **Width** text field, type  $w_{pc}$ .
- 4 In the **Depth** text field, type  $d_{batt}/2+w_{pc}/2$ .
- 5 In the **Height** text field, type  $h_{pc}$ .
- 6 Locate the **Position** section. In the **x** text field, type  $-w_{pc}/2$ .
- 7 In the **y** text field, type  $-w_{pc}/2$ .
- 8 In the **z** text field, type  $-h_{term}-h_{sc}-h_{pc}$ .
- 9 Click  **Build Selected**.

*Move 1 (mov1)*

- 1 In the **Geometry** toolbar, click  **Transforms** and choose **Move**.
- 2 Click the  **Zoom Extents** button in the **Graphics** toolbar.
- 3 Click the  **Transparency** button in the **Graphics** toolbar.
- 4 In the **Settings** window for **Move**, locate the **Input** section.
- 5 Click the  **Paste Selection** button for **Input objects**.
- 6 In the **Paste Selection** dialog, type blk1 in the **Selection** text field.
- 7 Click **OK**.
- 8 In the **Settings** window for **Move**, locate the **Input** section.
- 9 Select the **Keep input objects** checkbox.
- 10 Locate the **Displacement** section. In the **x** text field, type  $d_{batt}$ .
- 11 In the **z** text field, type  $h_{batt}+h_{term}*2+h_{sc}$ .
- 12 Click the  **Zoom Extents** button in the **Graphics** toolbar.

*Array 3 (arr3)*

- 1 In the **Geometry** toolbar, click  **Transforms** and choose **Array**.
- 2 In the **Settings** window for **Array**, locate the **Input** section.
- 3 Click the  **Paste Selection** button for **Input objects**.
- 4 In the **Paste Selection** dialog, type blk4 in the **Selection** text field.
- 5 Click **OK**.
- 6 In the **Settings** window for **Array**, locate the **Size** section.
- 7 In the **x size** text field, type 3.
- 8 In the **z size** text field, type 2.
- 9 Locate the **Displacement** section. In the **x** text field, type  $d_{batt}$ .

10 In the **z** text field, type  $h\_batt+2*(h\_term+h\_sc)+h\_pc$ .

11 Click  **Build Selected**.

*Move 1 (mov1)*

1 In the **Model Builder** window, click **Move 1 (mov1)**.

2 In the **Settings** window for **Move**, click  **Build Selected**.

3 Click  **Build All Objects**.

*Work Plane 1 (wp1)*

1 In the **Geometry** toolbar, click  **Work Plane**.

2 In the **Settings** window for **Work Plane**, locate the **Plane Definition** section.

3 In the **z-coordinate** text field, type  $-(h\_term+h\_sc+h\_pc)$ .

*Work Plane 1 (wp1) > Plane Geometry*

In the **Model Builder** window, click **Plane Geometry**.

*Work Plane 1 (wp1) > Circle 1 (c1)*

1 In the **Work Plane** toolbar, click  **Circle**.

2 In the **Settings** window for **Circle**, locate the **Size and Shape** section.

3 In the **Radius** text field, type  $r\_batt$ .

4 In the **Sector angle** text field, type 90.

5 Locate the **Rotation Angle** section. In the **Rotation** text field, type 180.

*Work Plane 1 (wp1) > Square 1 (sq1)*

1 In the **Work Plane** toolbar, click  **Square**.

2 In the **Settings** window for **Square**, locate the **Size** section.

3 In the **Side length** text field, type  $r\_batt$ .

4 Locate the **Position** section. In the **xw** text field, type  $-r\_batt$ .

5 In the **yw** text field, type  $-r\_batt$ .

*Work Plane 1 (wp1) > Difference 1 (dif1)*

1 In the **Work Plane** toolbar, click  **Booleans and Partitions** and choose **Difference**.

2 Click the  **Zoom Extents** button in the **Graphics** toolbar.

3 Select the object **sq1** only.



4 In the **Settings** window for **Difference**, locate the **Difference** section.

5 Click to select the  **Activate Selection** toggle button for **Objects to subtract**.





6 Click the  **Paste Selection** button for **Objects to subtract**.

- 7 In the **Paste Selection** dialog, type c1 in the **Selection** text field.
- 8 Click **OK**.
- 9 In the **Settings** window for **Difference**, click  **Build Selected**.

*Work Plane 1 (wp1) > Rectangle 1 (r1)*

- 1 In the **Work Plane** toolbar, click  **Rectangle**.
- 2 In the **Settings** window for **Rectangle**, locate the **Size and Shape** section.
- 3 In the **Width** text field, type  $3*(d\_batt)$ .
- 4 In the **Height** text field, type  $d\_batt$ .
- 5 Click  **Build Selected**.
- 6 Locate the **Position** section. In the **xw** text field, type  $-r\_batt$ .
- 7 In the **yw** text field, type  $-r\_batt$ .

*Work Plane 1 (wp1) > Difference 2 (dif2)*

- 1 In the **Work Plane** toolbar, click  **Booleans and Partitions** and choose **Difference**.
- 2 Select the object **r1** only.
- 3 In the **Settings** window for **Difference**, locate the **Difference** section.
- 4 Click to select the  **Activate Selection** toggle button for **Objects to subtract**.
- 5 Click the  **Zoom Extents** button in the **Graphics** toolbar.
- 6 Select the object **dif1** only.
- 7 Click  **Build Selected**.

*Extrude 1 (ext1)*

- 1 In the **Model Builder** window, right-click **Geometry 1** and choose **Extrude**.
- 2 In the **Settings** window for **Extrude**, locate the **Distances** section.
- 3 In the table, enter the following settings:

<b>Distances (m)</b>
$h\_term+h\_sc+h\_pc$
$h\_batt+h\_term+h\_sc+h\_pc$
$h\_batt+2*(h\_term+h\_sc+h\_pc)$

- 4 Click  **Build Selected**.

*Form Union (fin)*

In the **Geometry** toolbar, click  **Build All**.

### *Battery 1*

- 1 In the **Geometry** toolbar, click  **Selections** and choose **Explicit Selection**.
- 2 On the object **fin**, select Domain 4 only.
- 3 In the **Settings** window for **Explicit Selection**, type Battery 1 in the **Label** text field.

### *Battery 2*

- 1 In the **Geometry** toolbar, click  **Selections** and choose **Explicit Selection**.
- 2 On the object **fin**, select Domain 14 only.
- 3 In the **Settings** window for **Explicit Selection**, type Battery 2 in the **Label** text field.



### *Battery 3*

- 1 In the **Geometry** toolbar, click  **Selections** and choose **Explicit Selection**.
- 2 On the object **fin**, select Domain 22 only.
- 3 In the **Settings** window for **Explicit Selection**, type Battery 3 in the **Label** text field.



### *Air Domain*

- 1 In the **Geometry** toolbar, click  **Selections** and choose **Explicit Selection**.
- 2 On the object **fin**, select Domains 2, 3, 5, 12, 13, 20, 21, 28, and 29 only.
- 3 In the **Settings** window for **Explicit Selection**, type Air Domain in the **Label** text field.

### *Conductors*

- 1 In the **Geometry** toolbar, click  **Selections** and choose **Complement Selection**.
- 2 In the **Settings** window for **Complement Selection**, locate the **Input Entities** section.
- 3 Click  **Add**.
- 4 In the **Add** dialog, in the **Selections to invert** list, choose **Battery 1**, **Battery 2**, **Battery 3**, and **Air Domain**.
- 5 Click **OK**.
- 6 In the **Settings** window for **Complement Selection**, type Conductors in the **Label** text field.
- 7 In the **Geometry** toolbar, click  **Build All**.

### *Batteries*

- 1 In the **Geometry** toolbar, click  **Selections** and choose **Union Selection**.
- 2 In the **Settings** window for **Union Selection**, locate the **Input Entities** section.
- 3 Click  **Add**.
- 4 In the **Add** dialog, in the **Selections to add** list, choose **Battery 1**, **Battery 2**, and **Battery 3**.

5 Click **OK**.

6 In the **Settings** window for **Union Selection**, type Batteries in the **Label** text field.

#### *Batteries and Conductors*

1 In the **Geometry** toolbar, click  **Selections** and choose **Union Selection**.

2 In the **Settings** window for **Union Selection**, locate the **Input Entities** section.

3 Click **+ Add**.

4 In the **Add** dialog, in the **Selections to add** list, choose **Conductors** and **Batteries**.

5 Click **OK**.

6 In the **Settings** window for **Union Selection**, type Batteries and Conductors in the **Label** text field.

#### *Heat Flux Boundaries*

1 In the **Geometry** toolbar, click  **Selections** and choose **Explicit Selection**.

2 In the **Settings** window for **Explicit Selection**, locate the **Entities to Select** section.

3 From the **Geometric entity level** list, choose **Boundary**.

4 In the **Label** text field, type Heat Flux Boundaries.

5 Locate the **Entities to Select** section. Click the  **Paste Selection** button for **Entities to select**.

6 In the **Paste Selection** dialog, type fin: 2-10, 14, 15, 22, 44, 49, 54, 56, 58, 92, 97, 103, 138, 143, 148 in the **Selection** text field.

7 Click **OK**.

8 Click the  **Wireframe Rendering** button in the **Graphics** toolbar.

9 Click the  **Zoom Extents** button in the **Graphics** toolbar.

10 In the **Geometry** toolbar, click  **Build All**.

#### *Mesh Sweep Domains*

1 In the **Geometry** toolbar, click  **Selections** and choose **Box Selection**.

2 In the **Settings** window for **Box Selection**, type Mesh Sweep Domains in the **Label** text field.

3 Locate the **Box Limits** section. In the **z minimum** text field, type  $-h_{pc}/2$ .

4 In the **z maximum** text field, type  $h_{batt}+h_{pc}/2$ .

5 Locate the **Output Entities** section. From the **Include entity if** list, choose **Entity inside box**.