



Model created in COMSOL Multiphysics 6.4

Shape Optimization of a Rectangular Loudspeaker Horn in 3D

Introduction

This model shows how shape optimization can be used to design an acoustic loudspeaker horn. The horn is rectangular and this property can be maintained throughout the optimization by scaling the horn differently for different values of the z -coordinate. The scaling is performed isotropically in the x and y directions using a Bernstein polynomial. The objective function is computed using the built-in exterior field optimization function evaluated on-axis. The resulting design is exported to a second component for optimization with an objective function defined as the exterior field pressure evaluated off-axis. For this second optimization, the boundary of the horn is allowed to vary freely for, while only translation and rotation is allowed for the speaker boundary.

Problem Definition

The initial geometry of the horn is a pyramid, as shown in [Figure 1](#). The horn and speaker are placed in an infinite baffle configuration. Symmetry is exploited, so only half of the horn is modeled.

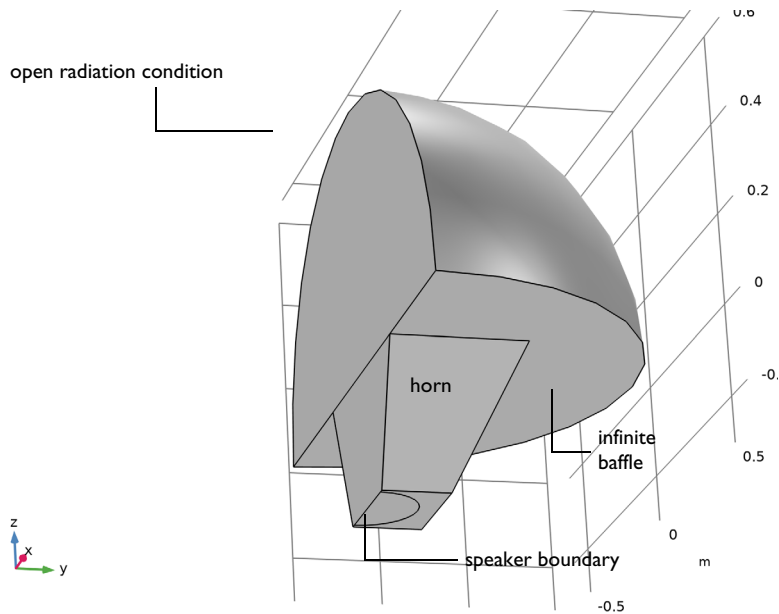

Figure 1: The initial geometry consists of a sphere outside the horn. The horn is placed in an infinite baffle and has the shape of a pyramid. A circle at the bottom of the horn is used for the idealized loudspeaker speaker driver.

ACOUSTIC PROBLEM

The horn and baffle boundaries are modeled as sound hard. The loudspeaker driver is represented with a simplified circular piston and a lumped model; see [Lumped Loudspeaker Driver](#). The lumped **Electrical Circuit** model is coupled to the acoustic domain using the **Lumped Speaker Boundary** feature. The **Exterior Field Calculation** feature is used to compute the radiated field at a distance of 1.2 m in front of the horn. The problem is only computed for a single frequency.

FIRST SHAPE OPTIMIZATION

The **Control Function** feature is used to scale the horn based on a Bernstein polynomial. The z -coordinate is used as argument for the function, and boundary condition are applied, so that no scaling is performed for the minimum and maximum value of the argument. The function is used in a **Prescribed Deformation** feature to scale the horn isotropically in the x and y directions.

The dedicated built-in optimization function for the exterior-field sound pressure level is evaluated on axis and used as objective function (the expression `Lp_pext_opt(0,0,R0)`). To limit the effects of impedance matching a constraint is imposed on the power of the speaker (the expression `acpr.lsb1.P_front`). The optimization problem is solved with the MMA optimization solver with an iteration limit of 20 and a move limit of 0.1 (to limit the design change between any two iterations)

The resulting design is exported to a new component using a **Filter** dataset.

SECOND SHAPE OPTIMIZATION

The design is now allow to change more freely in the sense that a **Free Shape Boundary** feature is used for the sides of the horn, while a **Transformation** feature is used on the speaker boundary. The latter is set up to allow translation and rotation around the y -axis.

The solver settings and objective function are recycled from the first optimization, but the objective function is changed such that the exterior field SPL is evaluated off-axis using the expression `comp2.Lp_pext_opt(R0*sin(theta0),0,R0*cos(theta0))`. The evaluation point is rotated by an angle `theta0` in the xz -plane. There is still a constraint on the speaker power, similar to the first on-axis optimization.

Results and Discussion

Figure 2 compares the radiation pattern for the initial design with the two optimized designs. The design optimized for off axis performance has the highest pressure both on- and off-axis, which can probably be attributed to the higher degree of design freedom.

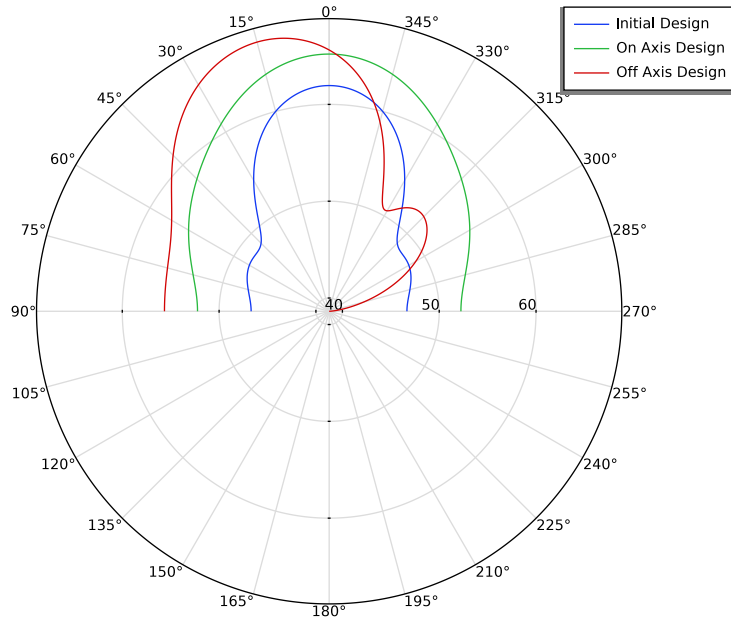

Figure 2: The exterior-field sound pressure level is evaluated at different angles for the three designs.

Looking at the actual designs one can see that the last optimization essentially rotates the horn, as shown in Figure 3.

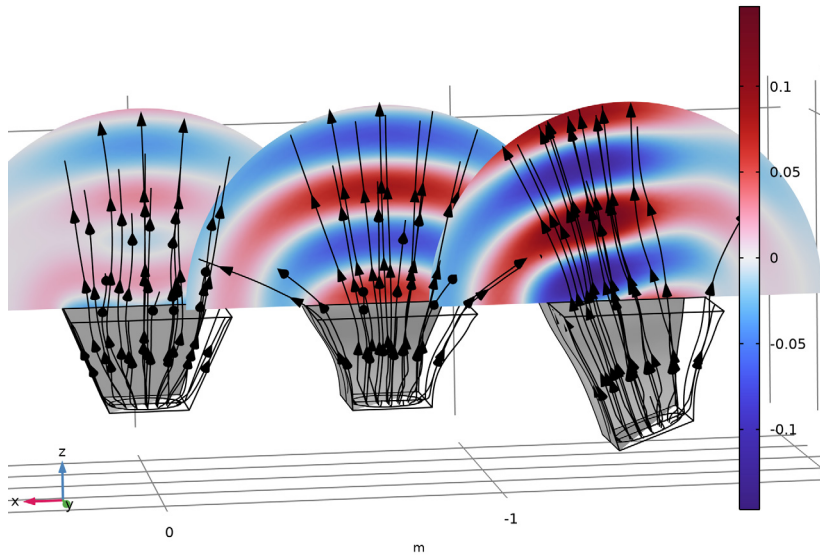



Figure 3: The total acoustic pressure is evaluated in a slice for the three designs. The intensity is plotted with streamlines, while half the speaker boundary is shown in gray.

Application Library path: Acoustics_Module/Optimization/
rectangular_horn_shape_optimization

Modeling Instructions



From the **File** menu, choose **New**.

NEW

In the **New** window, click  **Model Wizard**.

MODEL WIZARD

- 1 In the **Model Wizard** window, click  **3D**.
- 2 In the **Select Physics** tree, select **Acoustics** > **Pressure Acoustics** > **Pressure Acoustics, Frequency Domain (acpr)**.

- 3 Click **Add**.
- 4 In the **Select Physics** tree, select **AC/DC > Electrical Circuit (cir)**.
- 5 Click **Add**.
- 6 Click  **Study**.
- 7 In the **Select Study** tree, select **General Studies > Frequency Domain**.
- 8 Click  **Done**.



GLOBAL DEFINITIONS

Parameters I

- 1 In the **Model Builder** window, under **Global Definitions** click **Parameters I**.
- 2 In the **Settings** window for **Parameters**, locate the **Parameters** section.
- 3 Click  **Load from File**.
- 4 Browse to the model's Application Libraries folder and double-click the file `rectangular_horn_shape_optimization_parameters.txt`.

GEOMETRY I

Create the geometry. To simplify this step, insert a prepared geometry sequence.

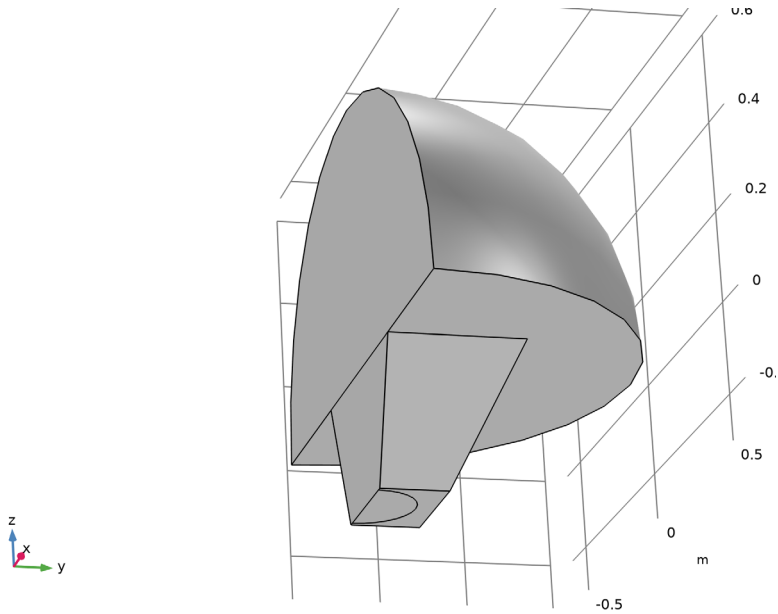

- 1 In the **Geometry** toolbar, click **Insert Sequence** and choose **Insert Sequence I**.
- 2 Browse to the model's Application Libraries folder and double-click the file `rectangular_horn_shape_optimization_geom_sequence.mph`.
- 3 In the **Geometry** toolbar, click  **Build All**.
- 4 Click the  **Zoom Extents** button in the **Graphics** toolbar.

- 5 In the **Model Builder** window, under **Component 1 (comp1)** click **Geometry 1**.



The geometry should now look like that in [Figure 1](#). Note that the inserted geometry is parameterized and that the parameters used are automatically added to the list of global parameters in the model.

ADD MATERIAL

- 1 In the **Materials** toolbar, click  **Add Material** to open the **Add Material** window.
- 2 Go to the **Add Material** window.
- 3 In the tree, select **Built-in > Air**.
- 4 Click the **Add to Component** button in the window toolbar.
- 5 In the **Materials** toolbar, click  **Add Material** to close the **Add Material** window.

PRESSURE ACOUSTICS, FREQUENCY DOMAIN (ACPR)

Exterior Field Calculation 1

- 1 In the **Physics** toolbar, click  **Boundaries** and choose **Exterior Field Calculation**.
- 2 In the **Settings** window for **Exterior Field Calculation**, locate the **Boundary Selection** section.
- 3 From the **Selection** list, choose **Exterior Field Boundary**.

- 4 Locate the **Exterior Field Calculation** section. From the **Condition in the $y = y_0$ plane** list, choose **Symmetric/Infinite sound hard boundary**.
- 5 From the **Condition in the $z = z_0$ plane** list, choose **Symmetric/Infinite sound hard boundary**.

Lumped Speaker Boundary I

- 1 In the **Physics** toolbar, click  **Boundaries** and choose **Lumped Speaker Boundary**.
- 2 In the **Settings** window for **Lumped Speaker Boundary**, locate the **Boundary Selection** section.
- 3 From the **Selection** list, choose **Speaker Driver**.
- 4 Locate the **Speaker Geometry** section. From the **Speaker area** list, choose **Use symmetries**.
- 5 Specify the vector as

0	x
0	y
1	z

- 6 Locate the **Back Volume Correction** section. In the V_{back} text field, type backV.

Perfectly Matched Boundary I

- 1 In the **Physics** toolbar, click  **Boundaries** and choose **Perfectly Matched Boundary**.
- 2 In the **Settings** window for **Perfectly Matched Boundary**, locate the **Boundary Selection** section.
- 3 From the **Selection** list, choose **Exterior Field Boundary**.

Symmetry I

- 1 In the **Physics** toolbar, click  **Boundaries** and choose **Symmetry**.
- 2 In the **Settings** window for **Symmetry**, locate the **Boundary Selection** section.
- 3 From the **Selection** list, choose **Symmetry Boundary**.

Refer to the loudspeaker_driver model for details on the lumped model for the driver.

ELECTRICAL CIRCUIT (CIR)

Voltage Source I (VI)

- 1 In the **Electrical Circuit** toolbar, click  **Voltage Source**.
- 2 In the **Settings** window for **Voltage Source**, locate the **Node Connections** section.

3 In the table, enter the following settings:

Label	Node names
n	0

4 Locate the **Device Parameters** section. In the v_{src} text field, type V0.

Resistor 1 (R1)

1 In the **Electrical Circuit** toolbar, click  **Resistor**.

2 In the **Settings** window for **Resistor**, locate the **Node Connections** section.

3 In the table, enter the following settings:

Label	Node names
p	1
n	2

4 Locate the **Device Parameters** section. In the R text field, type 3[ohm].

Inductor 1 (L1)

1 In the **Electrical Circuit** toolbar, click  **Inductor**.

2 In the **Settings** window for **Inductor**, locate the **Node Connections** section.

3 In the table, enter the following settings:

Label	Node names
p	2
n	3

4 Locate the **Device Parameters** section. In the L text field, type 0.25[mH].

Inductor 2 (L2)

1 Right-click **Inductor 1 (L1)** and choose **Duplicate**.

2 In the **Settings** window for **Inductor**, locate the **Node Connections** section.

3 In the table, enter the following settings:

Label	Node names
p	6
n	7

4 Locate the **Device Parameters** section. In the L text field, type 6[g]*1[H/kg].

Current-Controlled Voltage Source 1 (H1)

- 1 In the **Electrical Circuit** toolbar, click  **Current-Controlled Voltage Source**.
- 2 In the **Settings** window for **Current-Controlled Voltage Source**, locate the **Node Connections** section.
- 3 In the table, enter the following settings:

Label	Node names
p	3
n	0

- 4 Locate the **Current Measurement** section. From the **Measure current for device** list, choose **Inductor 2 (L2)**.
- 5 In the **Gain** text field, type $5[T*m]/1[T*m/ohm]$.

Current-Controlled Voltage Source 2 (H2)

- 1 Right-click **Current-Controlled Voltage Source 1 (H1)** and choose **Duplicate**.
- 2 In the **Settings** window for **Current-Controlled Voltage Source**, locate the **Node Connections** section.
- 3 In the table, enter the following settings:

Label	Node names
p	6
n	0

- 4 Locate the **Current Measurement** section. From the **Measure current for device** list, choose **Resistor 1 (R1)**.

Resistor 2 (R2)

- 1 In the **Electrical Circuit** toolbar, click  **Resistor**.
- 2 In the **Settings** window for **Resistor**, locate the **Node Connections** section.
- 3 In the table, enter the following settings:

Label	Node names
p	7
n	8

- 4 Locate the **Device Parameters** section. In the R text field, type $0.7[kg/s]*1[ohm/kg*s]$.

Capacitor 1 (C1)

- 1 In the **Electrical Circuit** toolbar, click  **Capacitor**.
- 2 In the **Settings** window for **Capacitor**, locate the **Node Connections** section.
- 3 In the table, enter the following settings:

Label	Node names
p	8
n	9

- 4 Locate the **Device Parameters** section. In the C text field, type $0.4[\text{mm/N}]*1[\text{F*N/m}]$.

External I vs. U 1 (IvsU1)

- 1 In the **Electrical Circuit** toolbar, click  **External I vs. U**.
- 2 In the **Settings** window for **External I vs. U**, locate the **Node Connections** section.
- 3 In the table, enter the following settings:

Label	Node names
p	9
n	0

- 4 Locate the **External Device** section. From the V list, choose **Voltage from lumped speaker boundary (acpr/lsb1)**.

MESH 1

Free Triangular 1

- 1 In the **Mesh** toolbar, click  **More Generators** and choose **Free Triangular**.
- 2 In the **Settings** window for **Free Triangular**, locate the **Boundary Selection** section.
- 3 From the **Selection** list, choose **Speaker Boundary**.

Size

- 1 In the **Model Builder** window, click **Size**.
- 2 In the **Settings** window for **Size**, click to expand the **Element Size Parameters** section.
- 3 In the **Maximum element size** text field, type meshsz.

Swept 1

- 1 In the **Mesh** toolbar, click  **Swept**.
- 2 In the **Settings** window for **Swept**, locate the **Domain Selection** section.
- 3 From the **Geometric entity level** list, choose **Domain**.

4 From the **Selection** list, choose **Pyramid I**.

Free Tetrahedral I

- 1 In the **Mesh** toolbar, click  **Free Tetrahedral**.
- 2 In the **Settings** window for **Free Tetrahedral**, locate the **Domain Selection** section.
- 3 From the **Geometric entity level** list, choose **Domain**.
- 4 From the **Selection** list, choose **Sphere I**.

Boundary Layers I

- 1 In the **Mesh** toolbar, click  **Boundary Layers**.
- 2 In the **Settings** window for **Boundary Layers**, locate the **Geometric Entity Selection** section.
- 3 From the **Geometric entity level** list, choose **Domain**.
- 4 From the **Selection** list, choose **Sphere I**.
- 5 Click to expand the **Transition** section. Clear the **Smooth transition to interior mesh** checkbox.

Boundary Layer Properties

- 1 In the **Model Builder** window, click **Boundary Layer Properties**.
- 2 In the **Settings** window for **Boundary Layer Properties**, locate the **Boundary Selection** section.
- 3 From the **Selection** list, choose **Exterior Field Boundary**.
- 4 Locate the **Layers** section. In the **Number of layers** text field, type 1.

STUDY I

Step 1: Frequency Domain

- 1 In the **Model Builder** window, under **Study I** click **Step 1: Frequency Domain**.
- 2 In the **Settings** window for **Frequency Domain**, locate the **Study Settings** section.
- 3 In the **Frequencies** text field, type f0.
- 4 In the **Model Builder** window, click **Study I**.
- 5 In the **Settings** window for **Study**, type Study 1: Initial Design in the **Label** text field.
- 6 In the **Study** toolbar, click  **Compute**.

RESULTS

Acoustic Pressure (acpr), Acoustic Pressure, Isosurfaces (acpr), Exterior-Field Pressure (acpr), Exterior-Field Sound Pressure Level (acpr), Exterior-Field Sound Pressure Level xy-plane (acpr), Sound Pressure Level (acpr)

Right-click and choose **Group**.

Initial Design

In the **Settings** window for **Group**, type **Initial Design** in the **Label** text field.

Add an **Evaluation Group** to compute the initial radiated power as well as the objectives.

Objective Function

1 In the **Results** toolbar, click  **Evaluation Group**.

2 In the **Settings** window for **Evaluation Group**, type **Objective Function** in the **Label** text field.

Global Evaluation 1

1 Right-click **Objective Function** and choose **Global Evaluation**.

2 In the **Settings** window for **Global Evaluation**, locate the **Expressions** section.

3 In the table, enter the following settings:

Expression	Unit	Description
Lp_pext_opt(0,0,R0)	dB	

4 Click **Add Expression** in the upper-right corner of the **Expressions** section. From the menu, choose **Component 1 (comp1) > Pressure Acoustics, Frequency Domain > Lumped Speaker Boundary 1 > acpr.lsbl.P_front - Radiated power (front) - W**.

5 In the **Objective Function** toolbar, click  **Evaluate**.

GLOBAL DEFINITIONS

Parameters 1

Define a parameter for the initial value of the radiated power, so that this can be used in a constraint.

1 In the **Model Builder** window, under **Global Definitions** click **Parameters 1**.

2 In the **Settings** window for **Parameters**, locate the **Parameters** section.

3 In the table, enter the following settings:

Name	Expression	Value	Description
P0	2.25[uW]	2.25E-6 W	Initial radiated power

COMPONENT 1 (COMP1)

Maximize the on-axis pressure by scaling the x- and y-coordinates using a **Control Function** feature.

DEFINITIONS (COMP1)

Control Function 1 (cfuncl)

1 In the **Definitions** toolbar, click  **Control Variables** and choose **Control Function**.

2 In the **Settings** window for **Control Function**, locate the **Control Variable Discretization** section.

3 In the **Order** text field, type 7.

4 Locate the **Output** section. In the f_{\min} text field, type -scaleMax.

5 In the f_{\max} text field, type scaleMax.

6 From the **Start boundary condition** list, choose **Dirichlet**.

7 From the **End boundary condition** list, choose **Dirichlet**.

8 In the e_0 text field, type 0.

9 Locate the **Units** section. Click  **Define Input Unit**.

10 In the **Argument quantity** table, enter the following settings:

Argument quantity	Argument unit
Custom unit	1

COMPONENT 1 (COMP1)

Prescribed Deformation 1

1 In the **Model Builder** window, right-click **Component 1 (comp1)** and choose **Deformed Geometry > Prescribed Deformation**.



2 In the **Settings** window for **Prescribed Deformation**, locate the **Geometric Entity Selection** section.

3 From the **Selection** list, choose **Pyramid 1**.

4 Locate the **Prescribed Deformation** section. Specify the dx vector as

$cfunc1((h0+Zg)/h0)*Xg$	X
$cfunc1((h0+Zg)/h0)*Yg$	Y
0	Z

ADD STUDY

- 1 In the **Home** toolbar, click  **Add Study** to open the **Add Study** window.
- 2 Go to the **Add Study** window.
- 3 Find the **Studies** subsection. In the **Select Study** tree, select **General Studies** > **Frequency Domain**.
- 4 Click the **Add Study** button in the window toolbar.
- 5 In the **Home** toolbar, click  **Add Study** to close the **Add Study** window.

STUDY 2

Step 1: Frequency Domain

- 1 In the **Settings** window for **Frequency Domain**, locate the **Study Settings** section.
- 2 In the **Frequencies** text field, type $f0$.
- 3 In the **Model Builder** window, click **Study 2**.
- 4 In the **Settings** window for **Study**, type **Study 2: Shape Optimization - On Axis** in the **Label** text field.

Shape Optimization

- 1 In the **Study** toolbar, click  **Optimization** and choose **Shape Optimization**.
- 2 In the **Settings** window for **Shape Optimization**, locate the **Optimization Solver** section.
- 3 From the **Method** list, choose **MMA**.
- 4 In the **Maximum number of iterations** text field, type 20.
Normalize the exterior-field pressure with the input power.
- 5 Click **Add Expression** in the upper-right corner of the **Objective Function** section. From the menu, choose **Component 1 (comp1)** > **Pressure Acoustics, Frequency Domain** > **Lumped Speaker Boundary 1** > **comp1.acpr.lsb1.P_front - Radiated power (front) - W**.
- 6 Locate the **Objective Function** section. In the table, enter the following settings:

Expression	Description
$comp1.Lp_pext_opt(0,0,R0)$	On axis objective

- 7 From the **Type** list, choose **Maximization**.
- 8 Find the **Objective settings** subsection. From the **Objective scaling** list, choose **Initial solution based**.
- 9 Click **Add Expression** in the upper-right corner of the **Constraints** section. From the menu, choose **Component 1 (comp1) > Pressure Acoustics, Frequency Domain > Lumped Speaker Boundary 1 > comp1.acpr.lsb1.P_front - Radiated power (front) - W**.
- 10 Locate the **Constraints** section. In the table, enter the following settings:

Expression	Lower bound	Upper bound
$\log_{10}(\text{comp1.acpr.lsb1.P_front}/P_0)$		0

- 11 In the **Study** toolbar, click  **Get Initial Value**.

RESULTS

Acoustic Pressure (acpr) 1, Acoustic Pressure, Isosurfaces (acpr) 1, Deformed Geometry, Exterior-Field Pressure (acpr) 1, Exterior-Field Sound Pressure Level (acpr) 1, Exterior-Field Sound Pressure Level xy-plane (acpr) 1, Sound Pressure Level (acpr) 1

- 1 In the **Model Builder** window, under **Results**, Ctrl-click to select **Acoustic Pressure (acpr) 1, Sound Pressure Level (acpr) 1, Acoustic Pressure, Isosurfaces (acpr) 1, Exterior-Field Sound Pressure Level (acpr) 1, Exterior-Field Pressure (acpr) 1, Exterior-Field Sound Pressure Level xy-plane (acpr) 1, and Deformed Geometry**.

- 2 Right-click and choose **Group**.

Shape Optimization - On Axis

In the **Settings** window for **Group**, type *Shape Optimization - On Axis* in the **Label** text field.

STUDY 2: SHAPE OPTIMIZATION - ON AXIS

Shape Optimization

- 1 In the **Model Builder** window, under **Study 2: Shape Optimization - On Axis** click **Shape Optimization**.
- 2 In the **Settings** window for **Shape Optimization**, click to expand the **Output** section.
- 3 Select the **Plot** checkbox.
- 4 From the **Plot group** list, choose **Acoustic Pressure (acpr) 1**.
- 5 In the **Study** toolbar, click  **Compute**.

RESULTS

Use a **Filter** dataset to transfer the optimization result to a new component via a **Mesh Part**.

Filter 1

- 1 In the **Results** toolbar, click  **More Datasets** and choose **Filter**.
- 2 In the **Settings** window for **Filter**, locate the **Data** section.
- 3 From the **Dataset** list, choose **Study 2: Shape Optimization - On Axis/Solution 2 (sol2)**.
- 4 Locate the **Expression** section. In the **Expression** text field, type 1.
- 5 Right-click **Filter 1** and choose **Create Mesh Part**.

ADD COMPONENT

In the **Model Builder** window, right-click the root node and choose **Add Component > 3D**.

COMPONENT 1: ON-AXIS OPTIMIZATION

In the **Settings** window for **Component**, type Component 1: On-Axis Optimization in the **Label** text field.

COMPONENT 2: OFF-AXIS OPTIMIZATION

- 1 In the **Model Builder** window, click **Component 2 (comp2)**.
- 2 In the **Settings** window for **Component**, type Component 2: Off-Axis Optimization in the **Label** text field.

GEOMETRY 2

Create the geometry. To simplify this step, recycle the prepared geometry sequence.

- 1 In the **Geometry** toolbar, click **Insert Sequence** and choose **Insert Sequence**.
- 2 Browse to the model's Application Libraries folder and double-click the file `rectangular_horn_shape_optimization_geom_sequence.mph`.

Moving Boundaries (boxsel2), Pyramid 1 (pyr1), Speaker Boundary (boxsel1), Speaker Driver (cylsel1), Work Plane 2 (wp2)

- 1 In the **Model Builder** window, under **Component 2: Off-Axis Optimization (comp2) > Geometry 2**, Ctrl-click to select **Pyramid 1 (pyr1)**, **Work Plane 2 (wp2)**, **Speaker Boundary (boxsel1)**, **Speaker Driver (cylsel1)**, and **Moving Boundaries (boxsel2)**.
- 2 Right-click and choose **Delete**.

Delete Entities 1 (dell)

- 1 In the **Model Builder** window, under **Component 2: Off-Axis Optimization (comp2) > Geometry 2** click **Delete Entities 1 (dell)**.

2 In the **Settings** window for **Delete Entities**, click  **Build Selected**.

Import 1 (imp1)

1 In the **Geometry** toolbar, click  **Import**.

2 In the **Settings** window for **Import**, locate the **Source** section.

3 From the **Source** list, choose **Mesh or 3D printing file (STL, 3MF, PLY)**.

4 From the **Mesh** list, choose **Mesh Part 1**.

5 Locate the **Simplify and Repair** section. Clear the **Simplify mesh** checkbox.

Form Union (fin)

1 In the **Model Builder** window, click **Form Union (fin)**.

2 In the **Settings** window for **Form Union/Assembly**, locate the **Form Union/Assembly** section.

3 From the **Repair tolerance** list, choose **Relative**.

4 In the **Relative repair tolerance** text field, type $1.0E-3$.

5 Click  **Build Selected**.

6 Click the  **Zoom Extents** button in the **Graphics** toolbar.

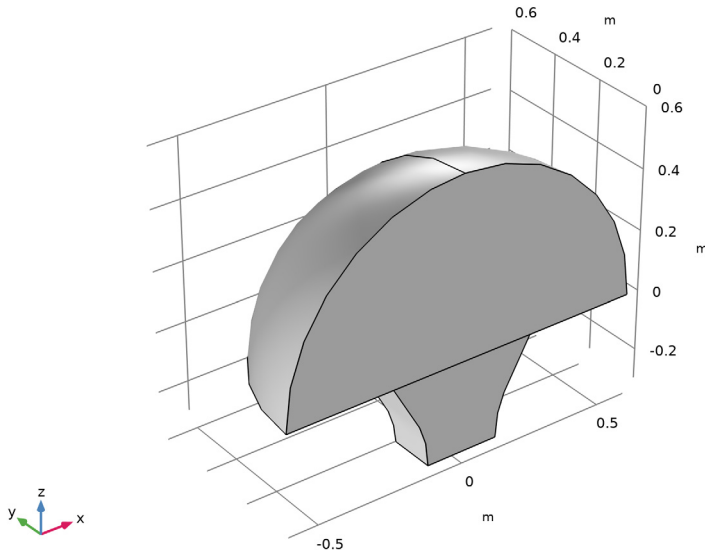

The geometry should now look like that in [Figure 2](#).

ELECTRICAL CIRCUIT (CIR), PRESSURE ACOUSTICS, FREQUENCY DOMAIN (ACPR)

- 1 In the **Model Builder** window, under **Component 1: On-Axis Optimization (comp1)**, Ctrl-click to select **Pressure Acoustics, Frequency Domain (acpr)** and **Electrical Circuit (cir)**.
- 2 Right-click and choose **Copy**.

PRESSURE ACOUSTICS, FREQUENCY DOMAIN (ACPR2)

In the **Model Builder** window, right-click **Component 2: Off-Axis Optimization (comp2)** and choose **Paste Multiple Items**.

ELECTRICAL CIRCUIT (CIR2), PRESSURE ACOUSTICS, FREQUENCY DOMAIN (ACPR2)

In the **Messages from Paste** dialog, click **OK**.

Exterior Field Calculation 1

- 1 In the **Model Builder** window, expand the **Component 2: Off-Axis Optimization (comp2)** > **Pressure Acoustics, Frequency Domain (acpr2)** node, then click **Exterior Field Calculation 1**.
- 2 In the **Settings** window for **Exterior Field Calculation**, locate the **Boundary Selection** section.
- 3 From the **Selection** list, choose **Exterior Field Boundary**.

Lumped Speaker Boundary 1

- 1 In the **Model Builder** window, click **Lumped Speaker Boundary 1**.
- 2 In the **Settings** window for **Lumped Speaker Boundary**, locate the **Boundary Selection** section.
- 3 From the **Selection** list, choose **Speaker Driver (Import 1)**.
- 4 Locate the **Speaker Geometry** section. Specify the vector as

-nx	x
-ny	y
-nz	z

Perfectly Matched Boundary 1

- 1 In the **Model Builder** window, click **Perfectly Matched Boundary 1**.
- 2 In the **Settings** window for **Perfectly Matched Boundary**, locate the **Boundary Selection** section.
- 3 From the **Selection** list, choose **Exterior Field Boundary**.

Symmetry I



- 1 In the **Model Builder** window, click **Symmetry I**.
- 2 In the **Settings** window for **Symmetry**, locate the **Boundary Selection** section.
- 3 From the **Selection** list, choose **Symmetry Boundary (Import I)**.

ELECTRICAL CIRCUIT (CIR2)

External I vs. U I (IvsUI)

- 1 In the **Model Builder** window, under **Component 2: Off-Axis Optimization (comp2)** > **Electrical Circuit (cir2)** click **External I vs. U I (IvsUI)**.
- 2 In the **Settings** window for **External I vs. U**, locate the **External Device** section.
- 3 From the **V** list, choose **Voltage from lumped speaker boundary (acpr2/lsb1)**.

ADD MATERIAL

- 1 In the **Materials** toolbar, click  **Add Material** to open the **Add Material** window.
- 2 Go to the **Add Material** window.
- 3 In the tree, select **Built-in** > **Air**.
- 4 Click the **Add to Component** button in the window toolbar.
- 5 In the **Materials** toolbar, click  **Add Material** to close the **Add Material** window.

COMPONENT 2: OFF-AXIS OPTIMIZATION (COMP2)

Free Shape Domain I

- 1 In the **Model Builder** window, right-click **Component 2: Off-Axis Optimization (comp2)** and choose **Shape Optimization** > **Shape Optimization**.
- 2 In the **Settings** window for **Free Shape Domain**, locate the **Domain Selection** section.
- 3 From the **Selection** list, choose **Pyramid I (Import I)**.

Free Shape Boundary I

- 1 In the **Shape Optimization** toolbar, click  **Free Shape Boundary**.
- 2 In the **Settings** window for **Free Shape Boundary**, locate the **Boundary Selection** section.
- 3 From the **Selection** list, choose **Moving Boundaries (Import I)**.
- 4 Locate the **Control Variable Settings** section. In the text field, type 0.2.
- 5 Locate the **Filtering** section. From the R_{\min} list, choose **Medium**.

Transformation I

- 1 In the **Shape Optimization** toolbar, click  **Transformation**.

- 2 In the **Settings** window for **Transformation**, locate the **Geometric Entity Selection** section.
- 3 From the **Geometric entity level** list, choose **Boundary**.
- 4 From the **Selection** list, choose **Speaker Boundary (Import 1)**.
- 5 Locate the **Translation** section. In the table, enter the following settings:

	Lock	Lower bound (m)	Upper bound (m)
X		-0.1	0.1
Y	√	-0.1	0.1
Z		-0.1	0.1

- 6 Locate the **Scaling** section. From the **Scaling type** list, choose **No scaling**.
- 7 Locate the **Rotation** section. From the **Rotation type** list, choose **Prescribed axis**.
- 8 From the **Axis** list, choose **y-axis**.
- 9 In the table, enter the following settings:

Lower bound (rad)	Upper bound (rad)
-20[deg]	20[deg]

Symmetry/Roller 1

- 1 In the **Shape Optimization** toolbar, click  **Symmetry/Roller**.
- 2 In the **Settings** window for **Symmetry/Roller**, locate the **Geometric Entity Selection** section.
- 3 From the **Selection** list, choose **Symmetry Boundary (Import 1)**.

MESH 2

Free Triangular 1

- 1 In the **Mesh** toolbar, click  **More Generators** and choose **Free Triangular**.
- 2 In the **Settings** window for **Free Triangular**, locate the **Boundary Selection** section.
- 3 From the **Selection** list, choose **Speaker Boundary (Import 1)**.

Size

- 1 In the **Model Builder** window, click **Size**.
- 2 In the **Settings** window for **Size**, locate the **Element Size Parameters** section.
- 3 In the **Maximum element size** text field, type meshsz.

Swept 1

- 1 In the **Mesh** toolbar, click  **Swept**.

- 2 In the **Settings** window for **Swept**, locate the **Domain Selection** section.
- 3 From the **Geometric entity level** list, choose **Domain**.
- 4 From the **Selection** list, choose **Pyramid I (Import I)**.

Free Tetrahedral I

- 1 In the **Mesh** toolbar, click  **Free Tetrahedral**.
- 2 In the **Settings** window for **Free Tetrahedral**, locate the **Domain Selection** section.
- 3 From the **Geometric entity level** list, choose **Domain**.
- 4 From the **Selection** list, choose **Sphere I**.



Boundary Layers I

- 1 In the **Mesh** toolbar, click  **Boundary Layers**.
- 2 In the **Settings** window for **Boundary Layers**, locate the **Geometric Entity Selection** section.
- 3 From the **Geometric entity level** list, choose **Domain**.
- 4 From the **Selection** list, choose **Sphere I**.
- 5 Locate the **Transition** section. Clear the **Smooth transition to interior mesh** checkbox.

Boundary Layer Properties

- 1 In the **Model Builder** window, click **Boundary Layer Properties**.
- 2 In the **Settings** window for **Boundary Layer Properties**, locate the **Boundary Selection** section.
- 3 From the **Selection** list, choose **Exterior Field Boundary**.
- 4 Locate the **Layers** section. In the **Number of layers** text field, type 1.

ADD STUDY

- 1 In the **Home** toolbar, click  **Add Study** to open the **Add Study** window.
- 2 Go to the **Add Study** window.
- 3 Find the **Physics interfaces in study** subsection. In the table, clear the **Solve** checkboxes for **Pressure Acoustics**, **Frequency Domain (acpr)** and **Electrical Circuit (cir)**.
- 4 Find the **Studies** subsection. In the **Select Study** tree, select **General Studies > Frequency Domain**.
- 5 Click the **Add Study** button in the window toolbar.
- 6 In the **Home** toolbar, click  **Add Study** to close the **Add Study** window.

STUDY 3

Step 1: Frequency Domain

- 1 In the **Settings** window for **Frequency Domain**, locate the **Study Settings** section.
- 2 In the **Frequencies** text field, type f_0 .

STUDY 2: SHAPE OPTIMIZATION - ON AXIS

Shape Optimization

- 1 In the **Model Builder** window, under **Study 2: Shape Optimization - On Axis** click **Shape Optimization**.
- 2 In the **Settings** window for **Shape Optimization**, locate the **Control Variables** section.
- 3 In the table, enter the following settings:

Control variable field	Solve for
Control Function I (cfuncl)	√
Free Shape Boundary I	
Transformation I	

- 4 Right-click **Study 2: Shape Optimization - On Axis** > **Shape Optimization** and choose **Copy**.

STUDY 3: SHAPE OPTIMIZATION - OFF AXIS

In the **Model Builder** window, right-click **Study 3** and choose **Paste Shape Optimization**.

- 1 In the **Settings** window for **Shape Optimization**, locate the **Objective Function** section.
- 2 In the table, enter the following settings:

Expression	Description
$\text{comp2.Lp_pext_opt}(R_0 \cdot \sin(\text{theta}_0), 0, R_0 \cdot \cos(\text{theta}_0))$	Off axis objective

- 3 Locate the **Control Variables** section. In the table, enter the following settings:

Control variable field	Solve for
Control Function I (cfuncl)	
Free Shape Boundary I	√
Transformation I	√

4 Locate the **Constraints** section. In the table, enter the following settings:

Expression	Lower bound	Upper bound
$\log_{10}(\text{comp2.acpr2.lsb1.P_front}/P_0)$		0

5 Locate the **Output** section. From the **Output table** list, choose **New**.

6 In the **Model Builder** window, click **Study 3**.

7 In the **Settings** window for **Study**, type Study 3: Shape Optimization - Off Axis in the **Label** text field.

8 In the **Study** toolbar, click  **Get Initial Value**.

RESULTS

Acoustic Pressure (acpr2), Acoustic Pressure, Isosurfaces (acpr2), Deformed Geometry I, Exterior-Field Pressure (acpr2), Exterior-Field Sound Pressure Level (acpr2), Exterior-Field Sound Pressure Level xy-plane (acpr2), Shape Optimization, Sound Pressure Level (acpr2)

Right-click and choose **Group**.

Shape Optimization - Off Axis

In the **Settings** window for **Group**, type Shape Optimization - Off Axis in the **Label** text field.

STUDY 2: SHAPE OPTIMIZATION - ON AXIS

Step 1: Frequency Domain

1 In the **Model Builder** window, under **Study 2: Shape Optimization - On Axis** click **Step 1: Frequency Domain**.

2 In the **Settings** window for **Frequency Domain**, locate the **Physics and Variables Selection** section.

3 In the **Solve for** column of the table, under **Component 2: Off-Axis Optimization (comp2)**, clear the checkboxes for **Pressure Acoustics, Frequency Domain (acpr2), Electrical Circuit (cir2),** and **Deformed Geometry**.

STUDY 1: INITIAL DESIGN

1 In the **Model Builder** window, under **Study 1: Initial Design** click **Step 1: Frequency Domain**.

2 In the **Settings** window for **Frequency Domain**, locate the **Physics and Variables Selection** section.

- In the **Solve for** column of the table, under **Component 2: Off-Axis Optimization (comp2)**, clear the checkboxes for **Pressure Acoustics, Frequency Domain (acpr2)**, **Electrical Circuit (cir2)**, and **Deformed Geometry**.

STUDY 3: SHAPE OPTIMIZATION - OFF AXIS

Shape Optimization

- In the **Model Builder** window, under **Study 3: Shape Optimization - Off Axis** click **Shape Optimization**.
- In the **Settings** window for **Shape Optimization**, locate the **Optimization Solver** section.
- From the **Method** list, choose **MMA**.
- Locate the **Output** section. From the **Plot group** list, choose **Shape Optimization**.
- In the **Study** toolbar, click  **Compute**.

RESULTS

Global Evaluation 2

- In the **Model Builder** window, under **Results > Objective Function** right-click **Global Evaluation 1** and choose **Duplicate**, so the objectives can be compared.
- In the **Settings** window for **Global Evaluation**, locate the **Data** section.
- From the **Dataset** list, choose **Study 2: Shape Optimization - On Axis/Solution 2 (sol2)**.

Global Evaluation 3

- Right-click **Global Evaluation 2** and choose **Duplicate**.
- In the **Settings** window for **Global Evaluation**, locate the **Data** section.
- From the **Dataset** list, choose **Study 3: Shape Optimization - Off Axis/Solution 3 (4) (sol3)**.
- Locate the **Expressions** section. In the table, enter the following settings:

Expression	Unit	Description
$Lp_pext_opt(R0*\cos(\theta_0), 0, R0*\sin(\theta_0))$	dB	
acpr2.lsb1.P_front	W	Radiated power (front)

- In the **Objective Function** toolbar, click  **Evaluate**.

Use a **Polar Plot Group** to compare the radiation pattern of the designs.

Radiation Comparison

- In the **Results** toolbar, click  **Polar Plot Group**.

- 2 In the **Settings** window for **Polar Plot Group**, type Radiation Comparison in the **Label** text field.
- 3 Click to expand the **Title** section. From the **Title type** list, choose **None**.
- 4 Locate the **Axis** section. From the **Zero angle** list, choose **Up**.

Radiation Pattern 1

- 1 In the **Radiation Comparison** toolbar, click  **More Plots** and choose **Radiation Pattern**.
- 2 In the **Settings** window for **Radiation Pattern**, locate the **Evaluation** section.
- 3 Find the **Angles** subsection. In the **Number of angles** text field, type 500.
- 4 From the **Restriction** list, choose **Manual**.
- 5 In the ϕ **start** text field, type -90.
- 6 In the ϕ **range** text field, type 180.
- 7 Find the **Normal vector** subsection. In the **y** text field, type 1.
- 8 In the **z** text field, type 0.
- 9 Find the **Reference direction** subsection. In the **x** text field, type 0.
- 10 In the **z** text field, type 1.

The other **Radiation Pattern** plots should be updated in the same way.

- 11 Click to expand the **Legends** section. Select the **Show legends** checkbox.
- 12 From the **Legends** list, choose **Manual**.
- 13 In the table, enter the following settings:

Legends
Initial Design

Radiation Pattern 2

Right-click **Radiation Pattern 1** and choose **Duplicate**.

Radiation Pattern 2

- 1 In the **Model Builder** window, expand the **Results > Initial Design > Exterior-Field Sound Pressure Level xy-plane (acpr)** node, then click **Results > Radiation Comparison > Radiation Pattern 2**.
- 2 In the **Settings** window for **Radiation Pattern**, locate the **Data** section.
- 3 From the **Dataset** list, choose **Study 2: Shape Optimization - On Axis/Solution 2 (sol2)**.



4 Locate the **Legends** section. In the table, enter the following settings:

Legends
On Axis Design

Radiation Pattern 3

- 1 Right-click **Results** > **Radiation Comparison** > **Radiation Pattern 2** and choose **Duplicate**.
- 2 In the **Settings** window for **Radiation Pattern**, locate the **Data** section.
- 3 From the **Dataset** list, choose **Study 3: Shape Optimization - Off Axis/Solution 3 (4) (sol3)**.
- 4 Click **Replace Expression** in the upper-right corner of the **Expression** section. From the menu, choose **Component 2: Off-Axis Optimization (comp2) > Pressure Acoustics, Frequency Domain > Exterior field > acpr2.efcl.Lp_pext - Exterior-field sound pressure level - dB**.
- 5 Locate the **Legends** section. In the table, enter the following settings:

Legends
Off Axis Design

- 6 In the **Radiation Comparison** toolbar, click  **Plot**.
- 7 Click the  **Zoom Extents** button in the **Graphics** toolbar.

The off-axis optimization does not lose any on-axis performance. Note that this would not be possible, if the on-axis optimization had the same amount of design freedom as the off-axis optimization.

Use **Mirror> 3D** datasets and a **3D Plot Group** to compare the designs.

Mirror 3D 1

- 1 In the **Results** toolbar, click  **More Datasets** and choose **Mirror 3D**.
- 2 In the **Settings** window for **Mirror 3D**, locate the **Plane Data** section.
- 3 From the **Plane** list, choose **zx-planes**.

Mirror 3D 2

- 1 Right-click **Mirror 3D 1** and choose **Duplicate**.
- 2 In the **Settings** window for **Mirror 3D**, locate the **Data** section.
- 3 From the **Dataset** list, choose **Study 2: Shape Optimization - On Axis/Solution 2 (sol2)**.

Mirror 3D 3

- 1 Right-click **Mirror 3D 2** and choose **Duplicate**.
- 2 In the **Settings** window for **Mirror 3D**, locate the **Data** section.

3 From the **Dataset** list, choose **Study 3: Shape Optimization - Off Axis/Solution 3 (4) (sol3)**.

Design Comparison

- 1 In the **Results** toolbar, click  **3D Plot Group**.
- 2 In the **Settings** window for **3D Plot Group**, type **Design Comparison** in the **Label** text field.
- 3 Locate the **Data** section. From the **Dataset** list, choose **Mirror 3D 1**.
- 4 Click to expand the **Title** section. From the **Title type** list, choose **None**.
- 5 Locate the **Plot Settings** section. Clear the **Plot dataset edges** checkbox.

Line 1

- 1 Right-click **Design Comparison** and choose **Line**.
- 2 In the **Settings** window for **Line**, locate the **Expression** section.
- 3 In the **Expression** text field, type 1.
- 4 Locate the **Coloring and Style** section. From the **Line type** list, choose **Tube**.
- 5 In the **Tube radius expression** text field, type $2e-3$.
- 6 Select the **Radius scale factor** checkbox.
- 7 From the **Coloring** list, choose **Uniform**.
- 8 From the **Color** list, choose **Black**.

Filter 1

- 1 Right-click **Line 1** and choose **Filter**.
- 2 In the **Settings** window for **Filter**, locate the **Element Selection** section.
- 3 In the **Logical expression for inclusion** text field, type $\text{mir1z} < \text{eps} \ \&\& \ \text{abs}(\text{mir1x}) < \text{L0} * 1.01 \ \&\& \ \text{abs}(\text{mir1y}) < \text{w0} * 1.01$.

Slice 1

- 1 In the **Model Builder** window, right-click **Design Comparison** and choose **Slice**.
- 2 In the **Settings** window for **Slice**, locate the **Plane Data** section.
- 3 From the **Plane** list, choose **zx-planes**.
- 4 In the **Planes** text field, type 1.

Filter 1

- 1 Right-click **Slice 1** and choose **Filter**.
- 2 In the **Settings** window for **Filter**, locate the **Element Selection** section.
- 3 In the **Logical expression for inclusion** text field, type $0 < \text{mir1z}$.

Surface 1

- 1 In the **Model Builder** window, right-click **Design Comparison** and choose **Surface**.
- 2 In the **Settings** window for **Surface**, locate the **Expression** section.
- 3 In the **Expression** text field, type 1.
- 4 Locate the **Coloring and Style** section. From the **Coloring** list, choose **Uniform**.
- 5 From the **Color** list, choose **Gray**.

Filter 1

- 1 Right-click **Surface 1** and choose **Filter**.
- 2 In the **Settings** window for **Filter**, locate the **Element Selection** section.
- 3 In the **Logical expression for inclusion** text field, type $Yg * \text{sign}(\text{mir1side} - 0.5) * L0 / w0 < Xg \ \&\& \ \text{mir1z} < -\text{eps} \ \&\& \ \text{eps} < \text{abs}(\text{mir1y})$.

Streamline 1

- 1 In the **Model Builder** window, right-click **Design Comparison** and choose **Streamline**.
- 2 In the **Settings** window for **Streamline**, locate the **Data** section.
- 3 From the **Dataset** list, choose **Study 1: Initial Design/Solution 1 (sol1)**.
- 4 Click **Replace Expression** in the upper-right corner of the **Expression** section. From the menu, choose **Component 1 (comp1) > Pressure Acoustics, Frequency Domain > Intensity > acpr.lx,acpr.ly,acpr.lz - Intensity**.
- 5 Locate the **Streamline Positioning** section. From the **Positioning** list, choose **On selected entities**.
- 6 Locate the **Selection** section. From the **Selection** list, choose **Speaker Driver**.
- 7 Locate the **Coloring and Style** section. Find the **Line style** subsection. From the **Type** list, choose **Tube**.
- 8 In the **Tube radius expression** text field, type $2e-3$.
- 9 Select the **Radius scale factor** checkbox.
- 10 Find the **Point style** subsection. From the **Type** list, choose **Arrow**.
- 11 From the **Color** list, choose **Black**.

Line 2

- 1 In the **Model Builder** window, under **Results > Design Comparison** right-click **Line 1** and choose **Duplicate**.
- 2 In the **Settings** window for **Line**, locate the **Data** section.
- 3 From the **Dataset** list, choose **Mirror 3D 2**.

Transformation 1

- 1 Right-click **Line 2** and choose **Transformation**.
- 2 In the **Settings** window for **Transformation**, locate the **Transformation** section.
- 3 In the **x** text field, type $-1.2 \cdot R_{air}$.
- 4 In the **y** text field, type $0.2 \cdot R_{air}$.

Slice 2

- 1 In the **Model Builder** window, under **Results > Design Comparison** right-click **Slice 1** and choose **Duplicate**.
- 2 In the **Settings** window for **Slice**, locate the **Data** section.
- 3 From the **Dataset** list, choose **Mirror 3D 2**.

Transformation 1

In the **Model Builder** window, under **Results > Design Comparison > Line 2** right-click **Transformation 1** and choose **Copy**.

Slice 2

- 1 In the **Model Builder** window, under **Results > Design Comparison** click **Slice 2**.
- 2 In the **Settings** window for **Slice**, click to expand the **Inherit Style** section.
- 3 From the **Plot** list, choose **Slice 1**.

Transformation 1

Right-click **Slice 2** and choose **Paste Transformation**.

Surface 2

- 1 In the **Model Builder** window, under **Results > Design Comparison** right-click **Surface 1** and choose **Duplicate**.
- 2 In the **Settings** window for **Surface**, locate the **Data** section.
- 3 From the **Dataset** list, choose **Mirror 3D 2**.

Transformation 1

Right-click **Surface 2** and choose **Paste Transformation**.

Streamline 2

- 1 In the **Model Builder** window, under **Results > Design Comparison** right-click **Streamline 1** and choose **Duplicate**.
- 2 In the **Settings** window for **Streamline**, locate the **Data** section.
- 3 From the **Dataset** list, choose **Study 2: Shape Optimization - On Axis/Solution 2 (sol2)**.

Transformation 1

Right-click **Streamline 2** and choose **Paste Transformation**.

Line 3

- 1 In the **Model Builder** window, under **Results > Design Comparison** right-click **Line 2** and choose **Duplicate**.
- 2 In the **Settings** window for **Line**, locate the **Data** section.
- 3 From the **Dataset** list, choose **Mirror 3D 3**.

Transformation 1

- 1 In the **Model Builder** window, expand the **Line 3** node, then click **Transformation 1**.
- 2 In the **Settings** window for **Transformation**, locate the **Transformation** section.
- 3 In the **x** text field, type $-2.4 \cdot R_{air}$.
- 4 In the **y** text field, type $0.4 \cdot R_{air}$.

Slice 3

- 1 In the **Model Builder** window, under **Results > Design Comparison** right-click **Slice 2** and choose **Duplicate**.
- 2 In the **Settings** window for **Slice**, locate the **Data** section.
- 3 From the **Dataset** list, choose **Mirror 3D 3**.
- 4 Click **Replace Expression** in the upper-right corner of the **Expression** section. From the menu, choose **Component 2: Off-Axis Optimization (comp2) > Pressure Acoustics, Frequency Domain > Pressure and sound pressure level > acpr2.p_t - Total acoustic pressure - Pa**.

Transformation 1

- 1 In the **Model Builder** window, expand the **Slice 3** node, then click **Transformation 1**.
- 2 In the **Settings** window for **Transformation**, locate the **Transformation** section.
- 3 In the **x** text field, type $-2.4 \cdot R_{air}$.
- 4 In the **y** text field, type $0.4 \cdot R_{air}$.

Surface 3

- 1 In the **Model Builder** window, under **Results > Design Comparison** right-click **Surface 2** and choose **Duplicate**.
- 2 In the **Model Builder** window, click **Surface 3**.
- 3 In the **Settings** window for **Surface**, locate the **Data** section.
- 4 From the **Dataset** list, choose **Mirror 3D 3**.



Transformation 1

- 1 In the **Model Builder** window, click **Transformation 1**.
- 2 In the **Settings** window for **Transformation**, locate the **Transformation** section.
- 3 In the **x** text field, type $-2.4 * R_{air}$.
- 4 In the **y** text field, type $0.4 * R_{air}$.

Streamline 3

- 1 In the **Model Builder** window, under **Results > Design Comparison** right-click **Streamline 2** and choose **Duplicate**.
- 2 In the **Settings** window for **Streamline**, locate the **Data** section.
- 3 From the **Dataset** list, choose **Study 3: Shape Optimization - Off Axis/Solution 3 (4) (sol3)**.
- 4 Click **Replace Expression** in the upper-right corner of the **Expression** section. From the menu, choose **Component 2: Off-Axis Optimization (comp2) > Pressure Acoustics, Frequency Domain > Intensity > acpr2.lx, ..., acpr2.lz - Intensity (spatial and material frames)**.
- 5 Locate the **Selection** section. From the **Selection** list, choose **Speaker Driver (Import 1)**.

Transformation 1

- 1 In the **Model Builder** window, expand the **Streamline 3** node, then click **Transformation 1**.
- 2 In the **Settings** window for **Transformation**, locate the **Transformation** section.
- 3 In the **x** text field, type $-2.4 * R_{air}$.
- 4 In the **y** text field, type $0.4 * R_{air}$.
- 5 In the **Design Comparison** toolbar, click  **Plot**.
- 6 Click the  **Zoom Extents** button in the **Graphics** toolbar.

Geometry Modeling Instructions

If you want to create the geometry yourself, follow these steps.

GLOBAL DEFINITIONS

Parameters 1

- 1 In the **Model Builder** window, under **Global Definitions** click **Parameters 1**.
- 2 In the **Settings** window for **Parameters**, locate the **Parameters** section.
- 3 Click  **Load from File**.

- 4 Browse to the model's Application Libraries folder and double-click the file `rectangular_horn_shape_optimization_parameters.txt`.

ADD COMPONENT

In the **Home** toolbar, click  **Add Component** and choose **3D**.

GEOMETRY I

Sphere 1 (sph1)

- 1 In the **Geometry** toolbar, click  **Sphere**.
- 2 In the **Settings** window for **Sphere**, locate the **Size** section.
- 3 In the **Radius** text field, type `Rair`.
- 4 Locate the **Selections of Resulting Entities** section. Select the **Resulting objects selection** checkbox.

Work Plane 1 (wp1)

In the **Geometry** toolbar, click  **Work Plane**.

Partition Objects 1 (par1)

- 1 In the **Geometry** toolbar, click  **Booleans and Partitions** and choose **Partition Objects**.
- 2 In the **Settings** window for **Partition Objects**, locate the **Partition Objects** section.
- 3 From the **Objects to partition** list, choose **Sphere 1**.
- 4 From the **Partition with** list, choose **Work plane**.

Delete Entities 1 (del1)



- 1 In the **Model Builder** window, right-click **Geometry I** and choose **Delete Entities**.
- 2 In the **Settings** window for **Delete Entities**, locate the **Entities or Objects to Delete** section.
- 3 From the **Geometric entity level** list, choose **Domain**.
- 4 Click to select the  **Activate Selection** toggle button for **Selection**.
- 5 On the object **par1**, select Domain 1 only.

Pyramid 1 (pyr1)

- 1 In the **Geometry** toolbar, click  **More Primitives** and choose **Pyramid**.
- 2 In the **Settings** window for **Pyramid**, locate the **Size and Shape** section.
- 3 In the **Base length 1** text field, type `L0`.
- 4 In the **Base length 2** text field, type `w0`.
- 5 In the **Height** text field, type `h0`.

- 6 In the **Ratio** text field, type 2.
- 7 Locate the **Position** section. In the **z** text field, type $-h_0$.
- 8 Locate the **Selections of Resulting Entities** section. Select the **Resulting objects selection** checkbox.

Sphere and Pyramid

- 1 In the **Geometry** toolbar, click  **Selections** and choose **Union Selection**.
- 2 In the **Settings** window for **Union Selection**, type Sphere and Pyramid in the **Label** text field.
- 3 Locate the **Geometric Entity Level** section. From the **Level** list, choose **Object**.
- 4 Locate the **Input Entities** section. Click  **Add**.
- 5 In the **Add** dialog, in the **Selections to add** list, choose **Sphere I** and **Pyramid I**.
- 6 Click **OK**.

Work Plane 2 (wp2)

- 1 In the **Geometry** toolbar, click  **Work Plane**.
- 2 In the **Settings** window for **Work Plane**, locate the **Plane Definition** section.
- 3 In the **z-coordinate** text field, type $-h_0$.

Work Plane 2 (wp2) > Plane Geometry

In the **Model Builder** window, click **Plane Geometry**.

Work Plane 2 (wp2) > Circle 1 (c1)

- 1 In the **Work Plane** toolbar, click  **Circle**.
- 2 In the **Settings** window for **Circle**, locate the **Size and Shape** section.
- 3 In the **Radius** text field, type r_{Speaker} .
- 4 In the **Sector angle** text field, type 180.

Box to Subtract

- 1 In the **Model Builder** window, right-click **Geometry 1** and choose **Block**.
- 2 In the **Settings** window for **Block**, type Box to Subtract in the **Label** text field.
- 3 Locate the **Size and Shape** section. In the **Width** text field, type $2 \cdot R_{\text{air}}$.
- 4 In the **Depth** text field, type R_{air} .
- 5 In the **Height** text field, type $R_{\text{air}} + h_0$.
- 6 Locate the **Position** section. In the **x** text field, type $-R_{\text{air}}$.
- 7 In the **y** text field, type $-R_{\text{air}}$.

- 8 In the **z** text field, type $-h_0$.
- 9 Locate the **Selections of Resulting Entities** section. Select the **Resulting objects selection** checkbox.

Difference 1 (dif1)

- 1 In the **Geometry** toolbar, click  **Booleans and Partitions** and choose **Difference**.
- 2 In the **Settings** window for **Difference**, locate the **Difference** section.
- 3 From the **Objects to add** list, choose **Sphere and Pyramid**.
- 4 From the **Objects to subtract** list, choose **Box to Subtract**.

Form Union (fin)

- 1 In the **Model Builder** window, click **Form Union (fin)**.
- 2 In the **Settings** window for **Form Union/Assembly**, click  **Build Selected**.

Exterior Field Boundary

- 1 In the **Geometry** toolbar, click  **Selections** and choose **Ball Selection**.
- 2 In the **Settings** window for **Ball Selection**, type Exterior Field Boundary in the **Label** text field.
- 3 Locate the **Geometric Entity Level** section. From the **Level** list, choose **Boundary**.
- 4 Locate the **Ball Center** section. In the **y** text field, type $R_{air} * 0.02$.
- 5 In the **z** text field, type R_{air} .
- 6 Locate the **Ball Radius** section. In the **Radius** text field, type $R_{air} * 0.01$.

Speaker Boundary

- 1 In the **Geometry** toolbar, click  **Selections** and choose **Box Selection**.
- 2 In the **Settings** window for **Box Selection**, type Speaker Boundary in the **Label** text field.
- 3 Locate the **Geometric Entity Level** section. From the **Level** list, choose **Boundary**.
- 4 Locate the **Box Limits** section. In the **z maximum** text field, type $-h_0 * 0.9$.
- 5 Locate the **Output Entities** section. From the **Include entity if** list, choose **Entity inside box**.

Speaker Driver



- 1 In the **Geometry** toolbar, click  **Selections** and choose **Cylinder Selection**.
- 2 In the **Settings** window for **Cylinder Selection**, type Speaker Driver in the **Label** text field.
- 3 Locate the **Geometric Entity Level** section. From the **Level** list, choose **Boundary**.
- 4 Locate the **Size and Shape** section. In the **Outer radius** text field, type $r_{Speaker} * 1.01$.

- 5 Locate the **Output Entities** section. From the **Include entity if** list, choose **Entity inside cylinder**.

Moving Boundaries

- 1 In the **Geometry** toolbar, click  **Selections** and choose **Box Selection**.
- 2 In the **Settings** window for **Box Selection**, type *Moving Boundaries* in the **Label** text field.
- 3 Locate the **Geometric Entity Level** section. From the **Level** list, choose **Boundary**.
- 4 Locate the **Box Limits** section. In the **z minimum** text field, type $-h_0 \cdot 0.9$.
- 5 In the **z maximum** text field, type $-h_0 \cdot 0.8$.

Symmetry Boundary

- 1 In the **Geometry** toolbar, click  **Selections** and choose **Box Selection**.
- 2 In the **Settings** window for **Box Selection**, type *Symmetry Boundary* in the **Label** text field.
- 3 Locate the **Geometric Entity Level** section. From the **Level** list, choose **Boundary**.
- 4 Locate the **Box Limits** section. In the **y maximum** text field, type *eps*.
- 5 Locate the **Output Entities** section. From the **Include entity if** list, choose **Entity inside box**.
- 6 In the **Geometry** toolbar, click  **Build All**.

The model geometry is now complete.