



Model created in COMSOL Multiphysics 6.4

Probe Tube Microphone

Introduction

It is often not possible to insert a normal microphone directly into the sound field being measured. The microphone may be too big to fit inside the measured system, such as for in-the-ear measurements for hearing aid fitting. The size of the microphone may also be too large compared to the wavelength, so that it disturbs the acoustic field. In these cases, a probe tube may be attached to the microphone case (see the sketch in [Figure 1](#)) in order to distance the microphone from the measurement point. In this model, the microphone sensitivity changes, due to the addition of this small probe, are investigated, see [Ref. 1](#) (Chapter 4, pp. 160–162) for further details.

This is a time-dependent model of a generic probe tube microphone setup consisting of an external acoustic domain, an elastic probe tube, and the cavity in front of the microphone diaphragm; see the sketch in [Figure 1](#). The probe tube, modeled using the Pipe Acoustics, Transient interface, is connected to two separate 3D pressure acoustics domains, leading to a fully coupled acoustics simulation.

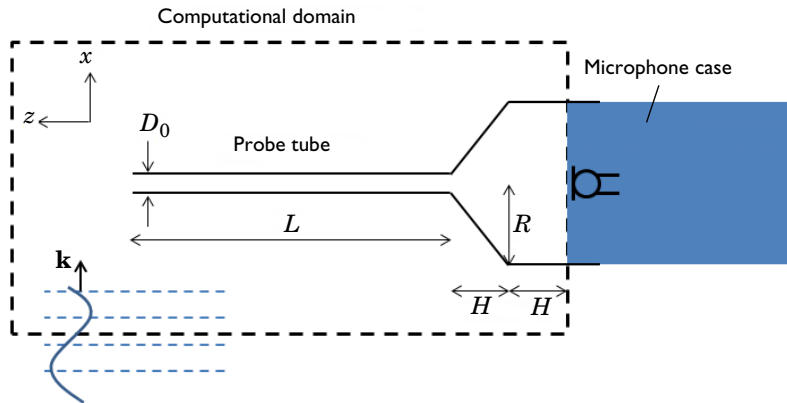

Figure 1: Sketch of the probe tube microphone setup, consisting of a probe tube of length L and outer diameter D_0 . The tube is connected to a cavity (with the indicated dimensions) in front of the microphone diaphragm. An external sound field hits the probe tube with wave vector \mathbf{k} .

Note: This model requires the Acoustics Module.

Model Definition

The probe tube microphone geometry and the computational domain considered in this model are shown schematically in [Figure 1](#). From right to left, the model consists of the cavity in front of the microphone, which takes the form of a cylinder of radius R and height H connected to a cone of bottom radius R and top radius D_0 . D_0 is also the outer diameter of the probe tube of length L . The probe is made of an elastic material with inner diameter $2d_r = 2$ mm and wall thickness $d_w = 0.3$ mm. The tube material is set to have a Young's modulus of 0.1 GPa and a Poisson's ratio of 0.4.

[Table 1](#) lists the model parameters,

TABLE 1: MODEL PARAMETERS.

VARIABLE	VALUE	DESCRIPTION
f	500 Hz	Incident wave frequency
T	$1/f$	Incident wave period
ω	$2\pi f$	Angular frequency
λ_{\min}	c_0/f	Minimum wavelength
c_0	343 m/s	Speed of sound
k	$2\pi/\lambda_{\min}$	Wave number
D_0	$2d_r + 2d_w = 2.6$ mm	Total pipe diameter
kD_0	$kD_0 = 0.02$	Wave number times tube diameter
d_{visc}	0.1 mm	Viscous boundary layer thickness at 500 Hz
L	20 mm	Probe tube length
R	5 mm	Microphone casing radius
H	5 mm	Probe tube volume height
d_r	1 mm	Pipe inner radius
d_w	0.3 mm	Pipe wall thickness

A sinusoidal wave moving in the positive x direction is incident on the probe tube microphone. The wave with an amplitude of 1 Pa is given by

$$p_{\text{in}} = 1 \text{ Pa} \cdot \sin(\omega t - kx) \quad (1)$$

where ω is the angular frequency, and k is the wave number (these are given in [Table 1](#)). Such a plane monochromatic wave exists as a built-in option for the **Incident Pressure Field** feature in the interface. In the transient analysis, a ramp is automatically added to smoothly increase the background pressure field amplitude over the first period $T = 1/f_0$. This is

done to ensure numerical stability and can be deactivated under the **Incident Pressure Field** with the **Advanced Physics Options** turned on.

Modeled using the Pipe Acoustics, Transient interface, the long probe tube is treated as a 1D structure. This assumption is valid as long as the interaction between the probe tube and the incoming sound field can be neglected. This, in turn, requires that $kD_0 \ll 1$, which is true for the current choice of parameters because $kD_0 = 0.02$; see [Table 1](#).

Another important assumption is that there are no significant thermal and viscous boundary losses inside the probe tube. Also this assumption holds for the current setup, where the incident field is a monochromatic wave. At a driving frequency of 500 Hz, the viscous boundary layer thickness inside the probe tube is of the order 0.1 mm, which is 10 times smaller than the internal radius d_T . The thickness of the boundary layer is proportional to $1/\sqrt{f}$.

Because the diaphragm is not a fully rigid structure, assume it to have a resistive loss given by the impedance $Z = 100 \cdot 10^6 \text{ Ns/m}^5$. This value is of the order of magnitude observed in common condenser microphones.

Results and Discussion

An important parameter of a probe tube extension to a microphone is the relation between the pressure at the tip and the pressure at the diaphragm (as measured by the microphone). This transfer function is necessary to calibrate the measurement system. The pressure at the tip of the probe and the pressure at the diaphragm are shown in [Figure 2](#). After an initial transient, the solution becomes periodic after about 4 ms. Hereafter, the system has a gain of about 1.4 and a phase shift equal to $\phi = \Delta t \cdot \omega = 0.1 \text{ ms} \cdot 2\pi f = 9^\circ$. The gain and phase shift depend on the frequency content of the applied signal — in this case a pure harmonic tone of 500 Hz.

A full transfer function could be obtained, for example, by using a Gaussian pulse as the incident signal and then performing a Fourier transform of the signal. This requires resolving the frequency content with an appropriate mesh that would become very dense. Moreover, the model assumptions might not hold for the full range of frequencies.

[Figure 3](#) depicts the pressure distribution in the xz -plane at the end of the time interval shown in [Figure 2](#).

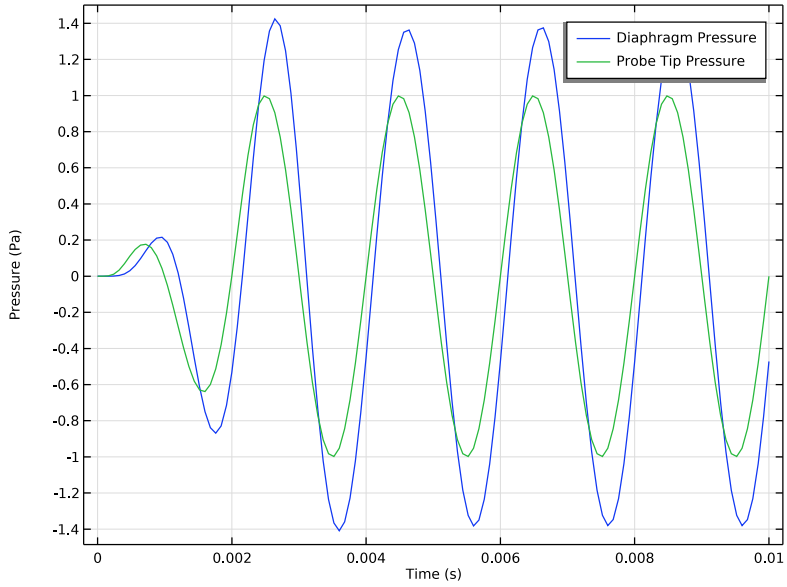

Figure 2: Pressure as a function of time at the probe tip (green line) and at the microphone diaphragm (blue line).

Time=0.01 s Slice: Acoustic pressure (Pa) Slice: Acoustic pressure (Pa) Line: Acoustic pressure (Pa)

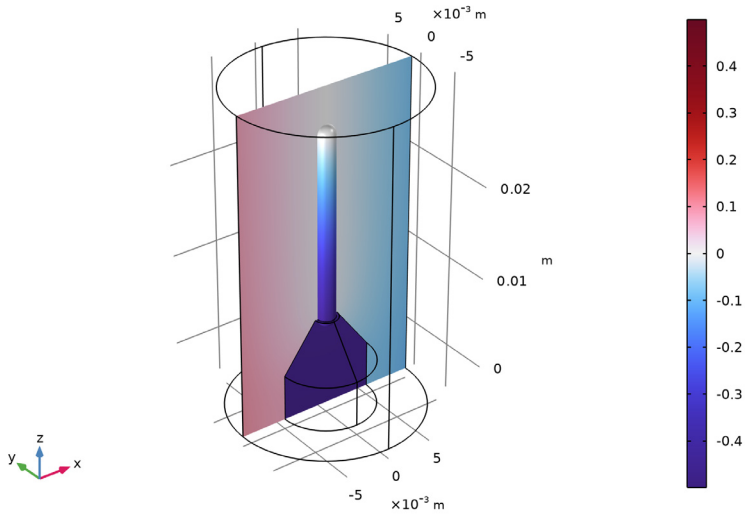

Figure 3: Pressure distribution in the xz -plane at time $t = 10$ ms.

COUPLING BETWEEN 1D AND 3D

The Pipe Acoustics interface used to model the probe tube is defined on edges, while the Pressure Acoustics interfaces are defined on 3D domains. At the probe tip, a pressure condition is used to connect the pressure in the exterior Pressure Acoustics domain to the probe tube. This manual coupling ensures continuity of pressure between the probe tube and the incident pressure field in the exterior domain.

The probe tube is connected to the second Pressure Acoustics domain (diaphragm cavity domain) through the Acoustics–Pipe Acoustics Connection multiphysics coupling. This coupling guarantees continuity of pressure and velocity through the equations

$$p_{\text{pipe}} = \frac{1}{A} \int p_t dS \quad (2)$$

$$-\mathbf{n} \cdot \left(-\frac{1}{\rho} (\nabla p_t - \mathbf{q}_d) \right) = \frac{\partial u_{\text{pipe}}}{\partial t} \quad (3)$$

where p_{pipe} is the pipe pressure at the connection point, A is the total area of the connected acoustic boundary, p_t is the total pressure in the acoustic domain, and S is the connected acoustic boundary. Furthermore, \mathbf{n} is the vector normal to the boundary, \mathbf{q}_d is a dipole source, and u_{pipe} is the pipe velocity at the connection point.

Note: Further examples of coupling between 1D pipes and 3D domains are found in the tutorial model [Acoustics of a Pipe System with 3D Bend and Junction](http://www.comsol.com/model/acoustics-of-a-pipe-system-with-3d-bend-and-junction-40831), also available in the Application Gallery: www.comsol.com/model/acoustics-of-a-pipe-system-with-3d-bend-and-junction-40831.

SOLVER SETUP

The only adjustment needed to be done to the solver is to change it from using a segregated approach to using a fully coupled approach. The default logic in the study is to use segregated groups for physics that do not have a built-in multiphysics coupling. Here, the coupling is set up manually in one of the ends of the pipe. The settings for the transient solver are handled automatically by setting the **Maximum frequency to resolve** in the **Transient Solver Settings** section (as done in the instructions below.)

Reference

1. D.T. Blackstock, *Fundamentals of Physical Acoustics*, John Wiley & Sons, 2000.
-

Application Library path: Acoustics_Module/Tutorials,_Pipe_Acoustics/
probe_tube_microphone



Modeling Instructions

From the **File** menu, choose **New**.

NEW

In the **New** window, click  **Model Wizard**.

MODEL WIZARD

- 1 In the **Model Wizard** window, click  **3D**.
- 2 In the **Select Physics** tree, select **Acoustics** > **Pipe Acoustics** > **Pipe Acoustics, Transient (patd)**.
- 3 Click **Add**.
- 4 In the **Select Physics** tree, select **Acoustics** > **Pressure Acoustics** > **Pressure Acoustics, Transient (actd)**.
- 5 Click **Add**.
- 6 In the **Select Physics** tree, select **Acoustics** > **Pressure Acoustics** > **Pressure Acoustics, Transient (actd)**.
- 7 Click **Add**.
- 8 Click  **Study**.
- 9 In the **Select Study** tree, select **General Studies** > **Time Dependent**.
- 10 Click  **Done**.

GLOBAL DEFINITIONS

Parameters 1

- 1 In the **Model Builder** window, under **Global Definitions** click **Parameters 1**.
- 2 In the **Settings** window for **Parameters**, locate the **Parameters** section.
- 3 Click  **Load from File**.



- 4 Browse to the model's Application Libraries folder and double-click the file `probe_tube_microphone_parameters.txt`.

GEOMETRY I

Next, define the geometry of the model. Either build the geometry by following the instructions at the end of the document or import the geometry from a sequence, and then jump to the **Materials** section. To import the geometry sequence, click **Insert Sequence** in the **Geometry** toolbar. Browse to the model's Application Libraries folder and open the file `probe_tube_microphone_geom_sequence.mph`.

- 1 In the **Geometry** toolbar, click **Insert Sequence** and choose **Insert Sequence**.
- 2 Browse to the model's Application Libraries folder and double-click the file `probe_tube_microphone_geom_sequence.mph`.
- 3 In the **Geometry** toolbar, click  **Build All**.

Use the wireframe rendering to more easily see and access faces and lines inside the geometry.



- 4 Click the  **Wireframe Rendering** button in the **Graphics** toolbar.
- 5 Click the  **Zoom Extents** button in the **Graphics** toolbar.

The geometry should look like the figure below.

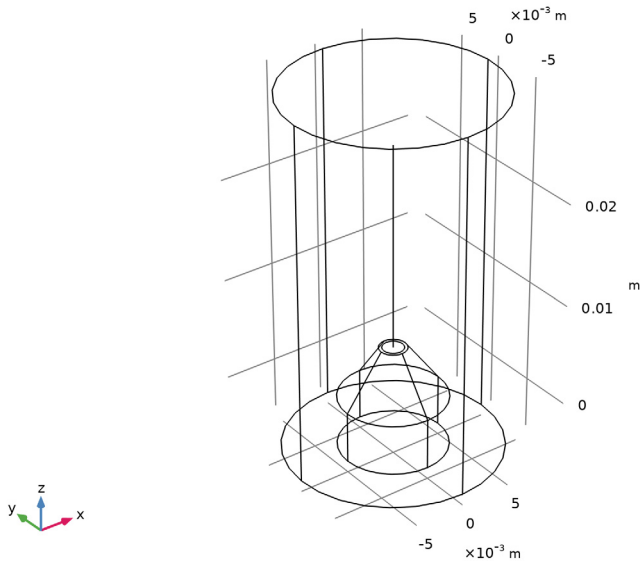
6 In the **Model Builder** window, under **Component 1 (comp1)** click **Geometry 1**.



ADD MATERIAL

- 1 In the **Materials** toolbar, click  **Add Material** to open the **Add Material** window.
- 2 Go to the **Add Material** window.
- 3 In the tree, select **Built-in > Air**.
- 4 Click the **Add to Component** button in the window toolbar.
- 5 In the tree, select **Built-in > Air**.
- 6 Click the **Add to Component** button in the window toolbar.
- 7 In the **Materials** toolbar, click  **Add Material** to close the **Add Material** window.

MATERIALS

Air 1 (mat2)

- 1 In the **Settings** window for **Material**, locate the **Geometric Entity Selection** section.
- 2 From the **Geometric entity level** list, choose **Edge**.
- 3 Select Edge 25 only.

DEFINITIONS

Average 1 (aveop1)

- 1 In the **Definitions** toolbar, click  **Nonlocal Couplings** and choose **Average**.
- 2 In the **Settings** window for **Average**, type aveop_mic in the **Operator name** text field.
- 3 Locate the **Source Selection** section. From the **Geometric entity level** list, choose **Boundary**.
- 4 Select Boundary 12 only.

Integration 1 (intop1)

- 1 In the **Definitions** toolbar, click  **Nonlocal Couplings** and choose **Integration**.
- 2 In the **Settings** window for **Integration**, type intop_tip in the **Operator name** text field.
- 3 Locate the **Source Selection** section. From the **Geometric entity level** list, choose **Point**.
- 4 Select Point 14 only.

PIPE ACOUSTICS, TRANSIENT (PATD)

Proceed to set up the physics of the problem. Select the domains where the different physics are applied and add the appropriate boundary conditions to couple these.

- 1 In the **Model Builder** window, under **Component 1 (comp1)** click **Pipe Acoustics, Transient (patd)**.
- 2 In the **Settings** window for **Pipe Acoustics, Transient**, locate the **Edge Selection** section.
- 3 Click  **Clear Selection**.
- 4 Select Edge 25 only.

Pipe Properties 1

- 1 In the **Model Builder** window, under **Component 1 (comp1)** > **Pipe Acoustics, Transient (patd)** click **Pipe Properties 1**.
- 2 In the **Settings** window for **Pipe Properties**, locate the **Pipe Shape** section.
- 3 From the list, choose **Circular**.
- 4 In the d_i text field, type $2 \cdot dr$.
- 5 Locate the **Pipe Model** section. From the **Pipe model** list, choose **Anchored at one end**.
- 6 From the E list, choose **User defined**. In the associated text field, type $0.1[\text{GPa}]$.
- 7 From the ν list, choose **User defined**. In the associated text field, type 0.4 .
- 8 In the Δw text field, type dw .
- 9 In the **Model Builder** window, click **Pipe Acoustics, Transient (patd)**.

10 In the **Settings** window for **Pipe Acoustics, Transient**, locate the **Transient Solver Settings** section.

11 In the $f_{\max, \text{sol}}$ text field, type f .

Pressure 1

1 In the **Physics** toolbar, click  **Points** and choose **Pressure**.

2 Select Point 14 only.

3 In the **Settings** window for **Pressure**, locate the **Pressure** section.

4 In the p_{in} text field, type p_2 .

This couples the exterior pressure to the probe tip.

PRESSURE ACOUSTICS, TRANSIENT (ACTD)

1 In the **Model Builder** window, under **Component 1 (comp1)** click **Pressure Acoustics, Transient (actd)**.

2 In the **Settings** window for **Pressure Acoustics, Transient**, locate the **Domain Selection** section.

3 Click  **Clear Selection**.

4 Select Domain 1 only.

5 Locate the **Transient Solver and Mesh Settings** section. In the f_{\max} text field, type f .

Cylindrical Wave Radiation 1

1 In the **Physics** toolbar, click  **Boundaries** and choose **Cylindrical Wave Radiation**.

2 Select Boundaries 1, 2, 13, and 18 only.

3 In the **Settings** window for **Cylindrical Wave Radiation**, locate the **Cylindrical Wave Radiation** section.

4 Specify the \mathbf{r}_{axis} vector as

0	x
0	y
1	z

Add an incident plane wave as defined in [Equation 1](#) using the built-in **Plane wave (monochromatic)** option. The wave is automatically multiplied with a smoothing ramp function over the first period. This option can be seen by enabling the **Advanced Physics Options** view.

Incident Pressure Field 1

- 1 In the **Physics** toolbar, click  **Attributes** and choose **Incident Pressure Field**.
- 2 In the **Settings** window for **Incident Pressure Field**, locate the **Incident Pressure Field** section.
- 3 In the p_0 text field, type 1.
- 4 From the c list, choose **From material**.
- 5 From the **Material** list, choose **Air (mat1)**.
- 6 Specify the \mathbf{e}_k vector as

1	x
0	y
0	z

- 7 In the f_0 text field, type f.

PRESSURE ACOUSTICS, TRANSIENT 2 (ACTD2)

- 1 In the **Model Builder** window, under **Component 1 (comp1)** click **Pressure Acoustics, Transient 2 (actd2)**.
- 2 In the **Settings** window for **Pressure Acoustics, Transient**, locate the **Domain Selection** section.
- 3 Click  **Clear Selection**.
- 4 Select Domains 2 and 3 only.
- 5 Locate the **Transient Solver and Mesh Settings** section. In the f_{\max} text field, type f.

Impedance 1

- 1 In the **Physics** toolbar, click  **Boundaries** and choose **Impedance**.
- 2 Select Boundary 7 only.
- 3 In the **Settings** window for **Impedance**, locate the **Impedance** section.
- 4 In the Z_n text field, type $100\text{e}6[\text{N}\cdot\text{s}/\text{m}^5]\cdot R^2\cdot\pi$.

MULTIPHYSICS

Acoustic–Pipe Acoustic Connection 1 (apc1)

- 1 In the **Physics** toolbar, click  **Multiphysics Couplings** and choose **Global > Acoustic–Pipe Acoustic Connection**.
- 2 In the **Settings** window for **Acoustic–Pipe Acoustic Connection**, locate the **Coupled Interfaces** section.

- 3 From the **Acoustics** list, choose **Pressure Acoustics, Transient 2 (actd2)**.

Selecting this second **Pressure Acoustics** interface is important, as otherwise the probe will have both ends connected to the exterior domain.

MESH 1

Proceed and generate the mesh based on the **Physics-controlled mesh** suggestion. The frequency controlling the maximum element size is per default taken **From study**, that is, from the **Maximum frequency to resolve**. In general, 5 to 6 second-order elements per wavelength are needed to resolve the waves. For more details, see *Meshing (Resolving the Waves)* in the *Acoustics Module User's Guide*. In this model, use 10 elements per wavelength; the default **Automatic** is to have 5.

- 1 In the **Model Builder** window, under **Component 1 (comp1)** click **Mesh 1**.
- 2 In the **Settings** window for **Mesh**, locate the **Pressure Acoustics, Transient (actd)** section.
- 3 From the **Number of mesh elements per wavelength** list, choose **User defined**.
- 4 In the text field, type 10.
- 5 Locate the **Pressure Acoustics, Transient 2 (actd2)** section. From the **Number of mesh elements per wavelength** list, choose **User defined**.
- 6 In the text field, type 10.
- 7 Locate the **Physics-Controlled Mesh** section. From the **Element size** list, choose **Coarse**.
- 8 Locate the **Sequence Type** section. From the list, choose **User-controlled mesh**.

Size 1

- 1 In the **Model Builder** window, right-click **Free Tetrahedral 1** and choose **Size**.
- 2 In the **Settings** window for **Size**, locate the **Geometric Entity Selection** section.
- 3 From the **Geometric entity level** list, choose **Edge**.
- 4 Select Edge 25 only.
- 5 Locate the **Element Size** section. Click the **Custom** button.
- 6 Locate the **Element Size Parameters** section.
- 7 Select the **Maximum element size** checkbox. In the associated text field, type L/10.

Size 2

- 1 Right-click **Free Tetrahedral 1** and choose **Size**.
- 2 In the **Settings** window for **Size**, locate the **Geometric Entity Selection** section.
- 3 From the **Geometric entity level** list, choose **Boundary**.
- 4 Select Boundary 12 only.

- 5 Locate the **Element Size** section. Click the **Custom** button.
- 6 Locate the **Element Size Parameters** section.
- 7 Select the **Maximum element size** checkbox. In the associated text field, type $dr/2$.
- 8 Click  **Build All**.

STUDY 1

Step 1: Time Dependent

- 1 In the **Model Builder** window, under **Study 1** click **Step 1: Time Dependent**.
- 2 In the **Settings** window for **Time Dependent**, locate the **Study Settings** section.
- 3 In the **Output times** text field, type range $(0, T/25, 5*T)$.
The data will be recorded for 5 periods ($5*T$) with a sampling of 25 points per period (increase the number of points to get better resolution in the stored solution).

Solution 1 (sol1)

- 1 In the **Study** toolbar, click  **Show Default Solver**.
- 2 In the **Model Builder** window, expand the **Solution 1 (sol1)** node.
- 3 In the **Model Builder** window, expand the **Study 1 > Solver Configurations > Solution 1 (sol1) > Time-Dependent Solver 1** node.
- 4 Right-click **Study 1 > Solver Configurations > Solution 1 (sol1) > Time-Dependent Solver 1** and choose **Fully Coupled**.

In this model, the coupling between the exterior **Pressure Acoustics** domain and the **Pipe Acoustics** interface is set up manually. The default behavior in the study is for COMSOL to generate solver suggestions for the individual constituting physics interfaces (notice the tags) and set up a segregated solver suggestion. However, this model is best solved using the fully coupled approach.

Now, solve the model and proceed to look at the results. First, look at the default plots and then create two custom plot groups. The model only takes a few seconds to solve.

- 5 In the **Model Builder** window, under **Study 1 > Solver Configurations > Solution 1 (sol1) > Time-Dependent Solver 1** click **Fully Coupled 1**.
- 6 In the **Settings** window for **Fully Coupled**, click  **Run**.

RESULTS

Acoustic Pressure (patd)

Time=0.01 s

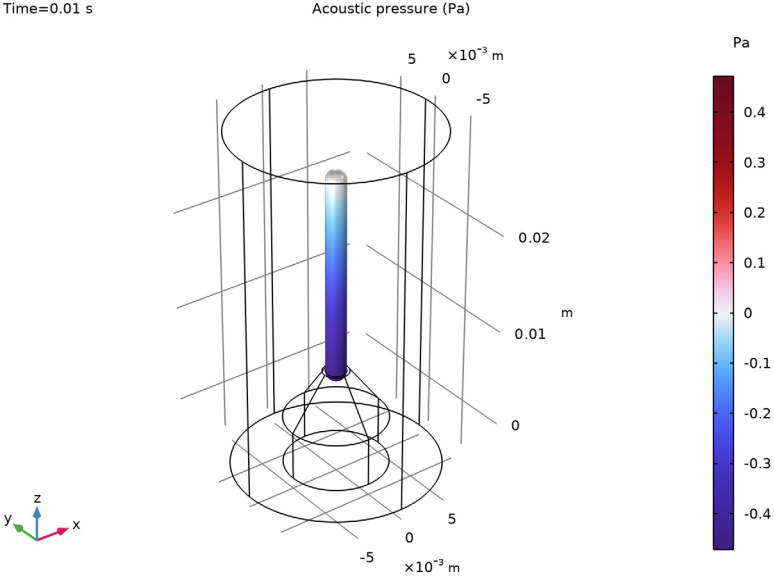

Acoustic Pressure (actd)

In the **Model Builder** window, click **Acoustic Pressure (actd)**.

Time=0.01 s

Total acoustic pressure (Pa)

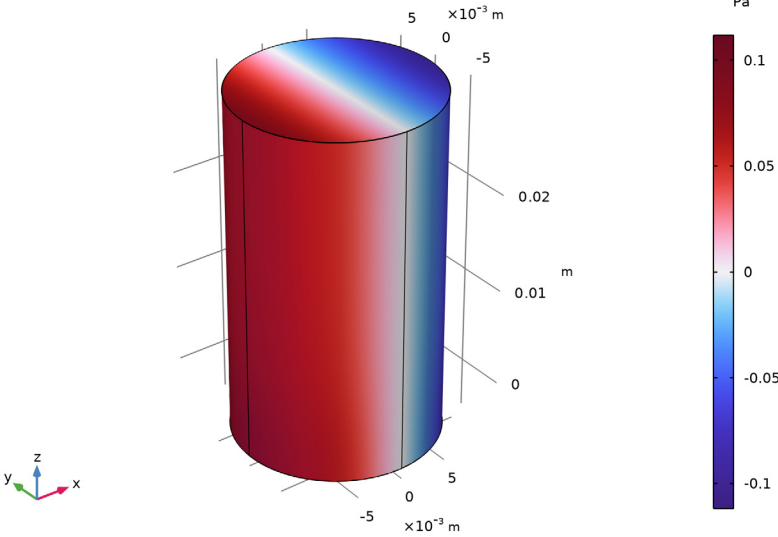

Acoustic Pressure, Isosurfaces (actd)

In the **Model Builder** window, click **Acoustic Pressure, Isosurfaces (actd)**.

Time=0.01 s

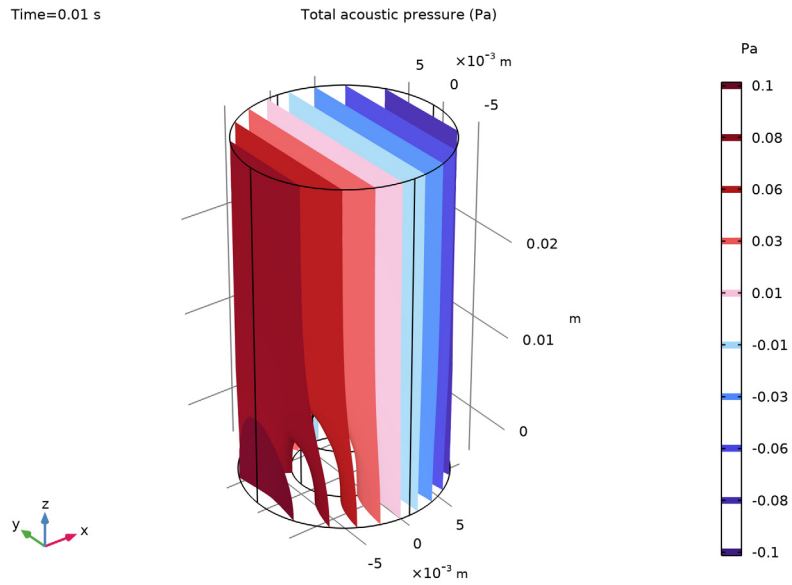

Acoustic Pressure (actd2)

In the **Model Builder** window, click **Acoustic Pressure (actd2)**.

Time=0.01 s

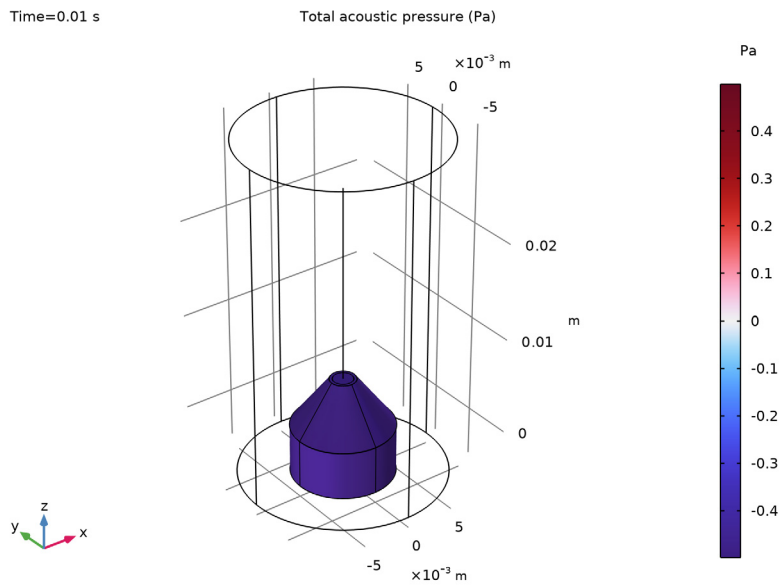

Acoustic Pressure, Isosurfaces (actd2)

1 In the **Model Builder** window, click **Acoustic Pressure, Isosurfaces (actd2)**.

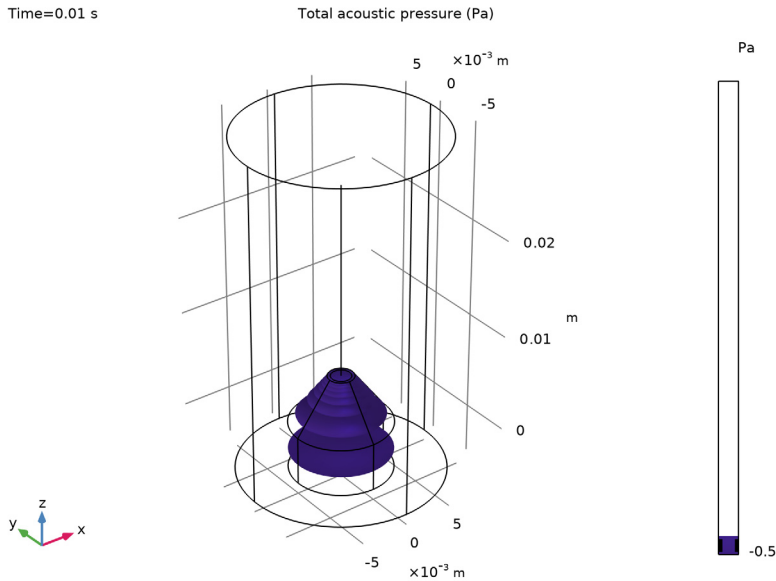

Follow the steps below to reproduce the plot in [Figure 3](#).

3D Plot Group 7

In the **Results** toolbar, click  **3D Plot Group**.

Slice 1

- 1 Right-click **3D Plot Group 7** and choose **Slice**.
- 2 In the **Settings** window for **Slice**, locate the **Expression** section.
- 3 In the **Expression** text field, type p_2 .
- 4 Locate the **Plane Data** section. From the **Plane** list, choose **ZX-planes**.
- 5 In the **Planes** text field, type 1.
- 6 Locate the **Coloring and Style** section. From the **Color table** list, choose **Wave**.
- 7 From the **Scale** list, choose **Linear symmetric**.

Slice 2

- 1 In the **Model Builder** window, right-click **3D Plot Group 7** and choose **Slice**.
- 2 In the **Settings** window for **Slice**, locate the **Expression** section.
- 3 In the **Expression** text field, type p_3 .

- 4 Locate the **Plane Data** section. From the **Plane** list, choose **ZX-planes**.
- 5 In the **Planes** text field, type 1.
- 6 Click to expand the **Inherit Style** section. From the **Plot** list, choose **Slice 1**.

Line 1

- 1 Right-click **3D Plot Group 7** and choose **Line**.
- 2 In the **Settings** window for **Line**, locate the **Coloring and Style** section.
- 3 From the **Line type** list, choose **Tube**.
- 4 In the **Tube radius expression** text field, type $0.5 \cdot \text{patd} \cdot \text{dh}$.
- 5 Select the **Radius scale factor** checkbox.
- 6 Click to expand the **Inherit Style** section. From the **Plot** list, choose **Slice 1**.
- 7 In the **3D Plot Group 7** toolbar, click  **Plot**.

Cross Sections

- 1 In the **Model Builder** window, under **Results** click **3D Plot Group 7**.
- 2 In the **Settings** window for **3D Plot Group**, type **Cross Sections** in the **Label** text field.
The figure should look like the one depicted in [Figure 3](#).

ID Plot Group 8

In the **Results** toolbar, click  **ID Plot Group**.

Global 1

- 1 Right-click **ID Plot Group 8** and choose **Global**.
- 2 In the **Settings** window for **Global**, locate the **y-Axis Data** section.
- 3 In the table, enter the following settings:

Expression	Unit	Description
aveop_mic(p3)	Pa	Diaphragm Pressure
intop_tip(p)	Pa	Probe Tip Pressure

Pressure Profiles

- 1 In the **Model Builder** window, click **ID Plot Group 8**.
- 2 In the **Settings** window for **ID Plot Group**, locate the **Plot Settings** section.
- 3 Select the **x-axis label** checkbox.
- 4 Select the **y-axis label** checkbox. In the associated text field, type **Pressure (Pa)**.
- 5 In the **ID Plot Group 8** toolbar, click  **Plot**.

6 In the **Label** text field, type Pressure Profiles.

The figure should look like the one in [Figure 2](#).

Appendix: Geometry Sequence Instructions

If you want to create the geometry yourself, follow these steps.

From the **File** menu, choose **New**.

NEW

In the **New** window, click  **Model Wizard**.

MODEL WIZARD

1 In the **Model Wizard** window, click  **3D**.

2 Click **Done**.

GLOBAL DEFINITIONS

Parameters I

1 In the **Model Builder** window, under **Global Definitions** click **Parameters I**.

2 In the **Settings** window for **Parameters**, locate the **Parameters** section.

3 In the table, enter the following settings:

Name	Expression	Value	Description
L	20[mm]	0.02 m	Probe tube length
R	5[mm]	0.005 m	Microphone casing radius
H	5[mm]	0.005 m	Probe tube volume height
dr	1[mm]	0.001 m	Pipe inner radius
dw	0.3[mm]	3E-4 m	Pipe wall thickness

GEOMETRY I

Cone I (cone1)

1 In the **Geometry** toolbar, click  **Cone**.

2 In the **Settings** window for **Cone**, locate the **Size and Shape** section.

3 In the **Bottom radius** text field, type R.

4 In the **Height** text field, type H.

5 In the **Top radius** text field, type dr+dw.

Cylinder 1 (cyl1)

- 1 In the **Geometry** toolbar, click  **Cylinder**.
- 2 In the **Settings** window for **Cylinder**, locate the **Size and Shape** section.
- 3 In the **Radius** text field, type R.
- 4 In the **Height** text field, type H.
- 5 Locate the **Position** section. In the **z** text field, type -H.

Polygon 1 (pol1)

- 1 In the **Geometry** toolbar, click  **More Primitives** and choose **Polygon**.
- 2 In the **Settings** window for **Polygon**, locate the **Coordinates** section.
- 3 From the **Data source** list, choose **Vectors**.
- 4 In the **x** text field, type 0 0.
- 5 In the **y** text field, type 0 0.
- 6 In the **z** text field, type H H+L.

Cylinder 2 (cyl2)

- 1 In the **Geometry** toolbar, click  **Cylinder**.
- 2 In the **Settings** window for **Cylinder**, locate the **Size and Shape** section.
- 3 In the **Radius** text field, type 10 [mm].
- 4 In the **Height** text field, type 35 [mm].
- 5 Locate the **Position** section. In the **z** text field, type -H.

Work Plane 1 (wp1)

- 1 In the **Geometry** toolbar, click  **Work Plane**.
- 2 In the **Settings** window for **Work Plane**, locate the **Plane Definition** section.
- 3 From the **Plane type** list, choose **Face parallel**.
- 4 On the object **cone1**, select Boundary 4 only.

Work Plane 1 (wp1) > Plane Geometry

In the **Model Builder** window, click **Plane Geometry**.

Work Plane 1 (wp1) > Circle 1 (c1)

- 1 In the **Work Plane** toolbar, click  **Circle**.
- 2 In the **Settings** window for **Circle**, locate the **Size and Shape** section.
- 3 In the **Radius** text field, type dr.

Form Union (fin)

In the **Home** toolbar, click  **Build All**.