

Model created in COMSOL Multiphysics 6.4

Acoustics in a Single-Family Home

Introduction

The study of acoustics over several floors in a building can give essential information for industrial settings with machinery but also for dwellings. Especially, the noise level caused by constant sources is a valuable quantity to evaluate whether an environment is acoustically comfortable or not. Problems with such a large geometry scale are best modeled with the acoustic diffusion equation, which makes use of the high-frequency limit to assume a perfectly diffuse sound field (see [Ref. 1](#) and [Ref. 2](#)).

This tutorial model shows the basic steps and principles used when setting up a model using the *Acoustic Diffusion Equation* physics interface. In the model, the acoustics of a single-family home is investigated. The model setup includes studies for steady state, eigenvalue, and transient analyses. This allows to derive the sound pressure level distribution and reverberation times in the different rooms. The sound pressure level radiated outside the house is also determined with a manual coupling to the *Ray Acoustics* physics interface.

Model Definition

In this model the acoustics of a generic single-family home is analyzed over broadband frequency. It is a two-story house consisting of 10 rooms, as depicted in [Figure 1](#). The rooms are coupled with each other either by defining the transmission loss of the partition between them or by forcing continuity in the sound field. Two types of partitions are defined in this model, namely light and heavy, with transmission losses of 5 dB and 10 dB respectively. Wall boundary conditions are entered as absorption coefficients, with values assumed to be realistic for the materials in the model ([Ref. 3](#)). The acoustic mean free path in each room is also calculated with a simple equation based on the room volume and surface area from [Ref. 4](#). For complex geometries, however, the mean free path should be measured or estimated from a separate detailed model. A monopole point source is located in the living room at the coordinates (x_s, y_s, z_s) and radiates with a power P_s . These are parameters found under **Global Definitions > Parameters I - Source**.

Three studies with the *Acoustic Diffusion Equation* physics interface are performed to assess the acoustic conditions inside the house. The first one is a stationary study, returning sound field properties caused by constant emission from the source. The second study investigates the eigenvalues in the problem to analyze the modal behavior of the model. The last study looks into the transient decay of sound when the constant source is turned off. Following these, a fourth study investigates the sound field outside the house thanks

to the *Ray Acoustics* physics interface. The outdoor area on one side of the house adjacent to the living room is considered.

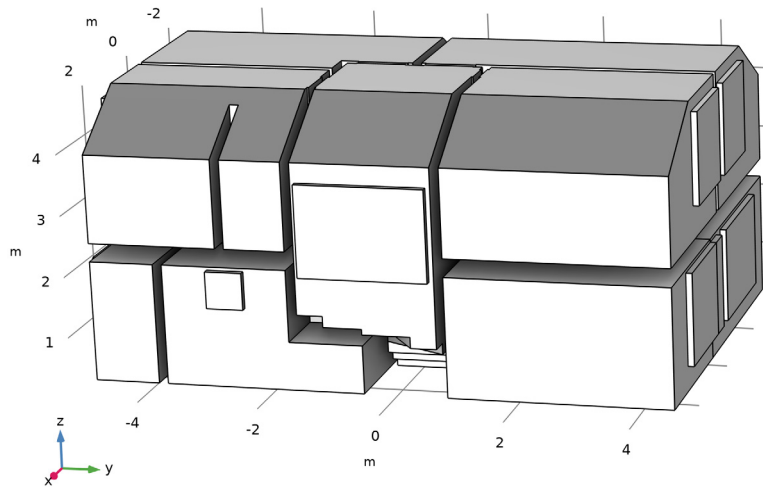

Figure 1: Geometry of the single-family home.

The coupling between the *Acoustic Diffusion Equation* and the *Ray Acoustics* interfaces is done manually. Sound is assumed to be radiated uniformly from the two windows closest to the source. The sound power incident on each window is then calculated from the stationary study and used as input to the Release from Boundary feature in *Ray Acoustics*. Transmission loss through the windows is also applied to obtain the correct total power radiated.

Results and Discussion

The sound pressure level (SPL) caused by a constant source is depicted in [Figure 2](#) on slices and in [Figure 3](#) on the boundaries of the model. It is naturally seen that the highest SPL is found in the rooms closest to the source, especially the living room and the staircase which were coupled together with a continuous sound field. The decrease in SPL as rooms get further from the source is due both to transmission loss through partitions and to absorption within rooms.

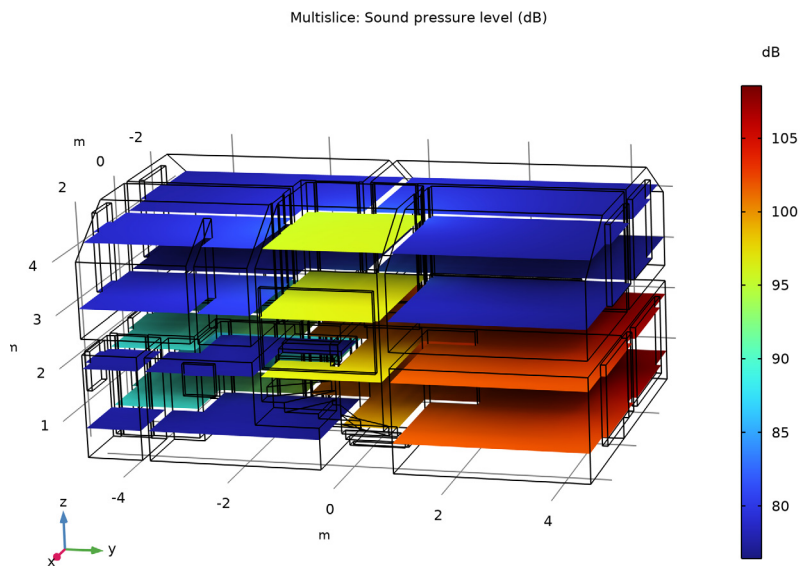

Figure 2: SPL on horizontal slices of the model.

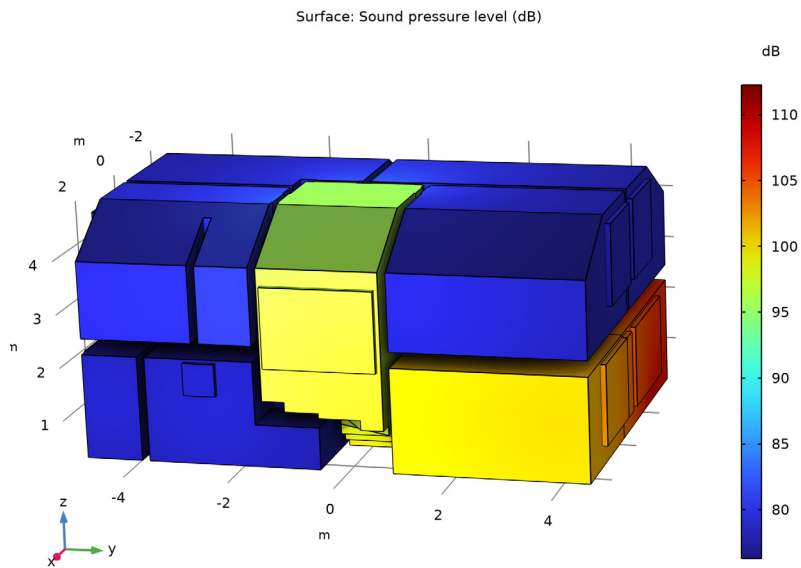

Figure 3: SPL on the boundaries of the model.

The energy distribution in the house can also be studied by means of sound energy density as plotted in Figure 4. The linear scale of this quantity makes it more suited to analyze the direct surroundings of the source, as opposed to the logarithmic scale of the SPL. Due to its location close to a corner, the radiation pattern appears as if the source was broader than a single monopole point.

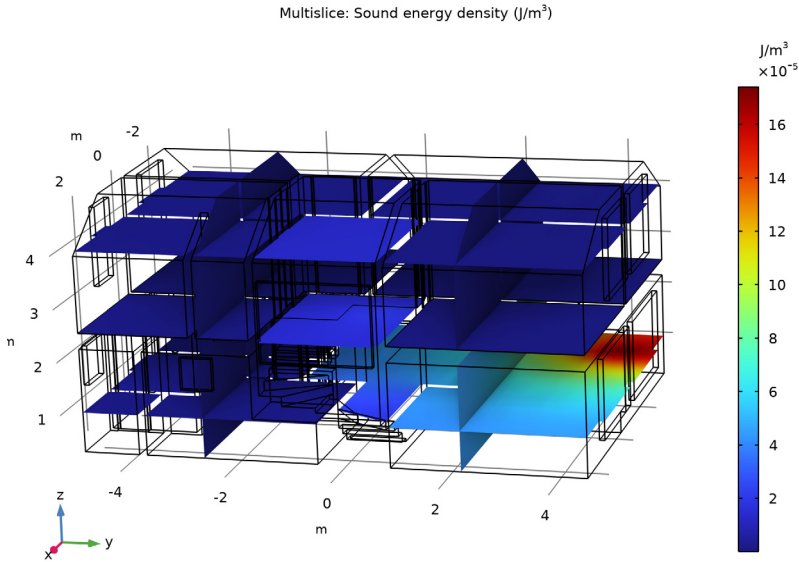

Figure 4: Sound energy density in the house with a constant source.

In addition to energy distribution, the local energy flux through the house is represented in Figure 5. The location of the point source is naturally seen as the origin of the energy flux, and the propagation to adjacent rooms and up the staircase is clearly visible. While

this result could easily be anticipated given the simplicity of the study case, such an analysis can give valuable information in a more complex setting.

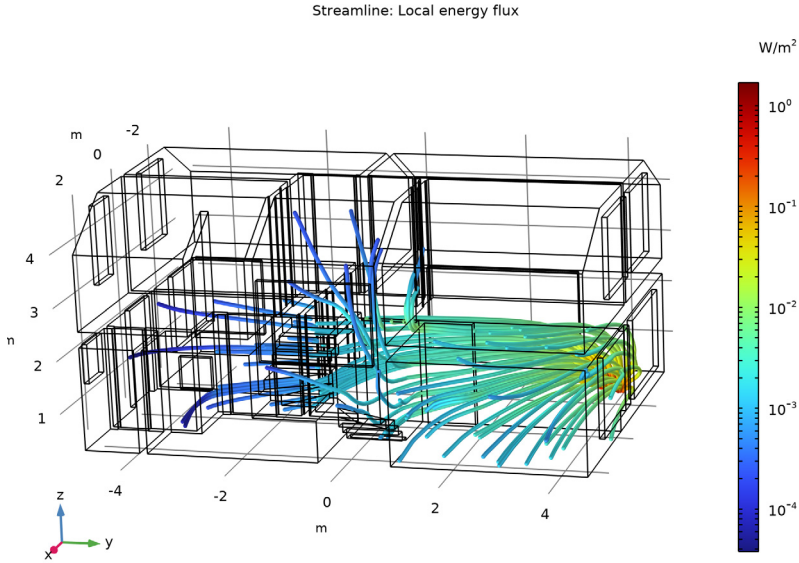

Figure 5: Energy flux through the house caused by a point source.

The reverberation times T_{60} shown in Figure 6 were obtained from Eyring–Norris formula

$$T_{60} = \frac{55.3V}{cA + 4m_aV} \quad (1)$$

with V the volume of the given room, c the speed of sound, A the absorption area of the room, and m_a the air absorption constant. The study was carried out for broadband frequency, resulting in one value for each room. The reverberation times found lie between

0.3 s and 0.65 s. These are coherent values given the small volumes of the rooms in the house.

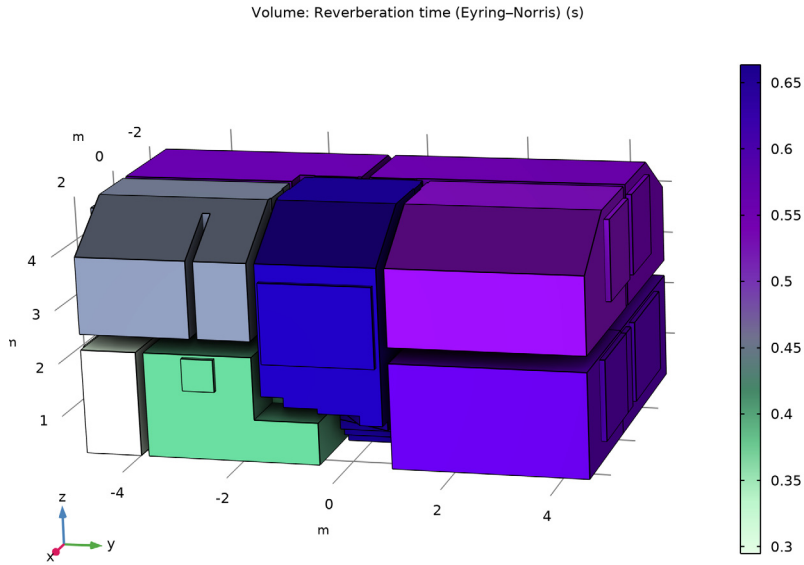

Figure 6: Eyring–Norris reverberation times of the rooms.

The eigenvalue study allows to investigate the modes in the building. For example, the third sound energy density mode is displayed in [Figure 7](#). It shows that two adjacent rooms on the first floor are excited together at the eigenvalue $\lambda = 23.45$ rad/s. The eigenvalues describe the exponential decays of the modes, they are therefore directly linked to the reverberation times of the rooms or groups of coupled rooms through the formula $T_{60} = 55.3/4\lambda$. The relation between the first ten eigenvalues and reverberation times is

given in Table 1. Use the table in combination with the figure to identify the reverberation times of the different spaces.

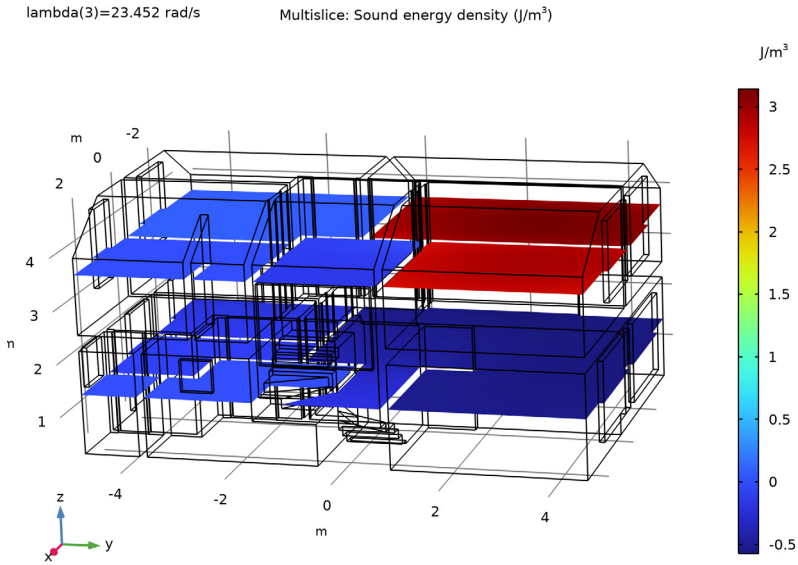

Figure 7: Sound energy density mode at $\lambda = 23.45 \text{ rad/s}$.

TABLE 1: FIRST TEN EIGENVALUES WITH THEIR ASSOCIATED REVERBERATION TIMES.

Eigenvalues (rad/s)	Reverberation times (s)
21.66	0.638
22.89	0.604
23.45	0.589
26.95	0.513
28.35	0.487
31.85	0.434
32.75	0.422
35.91	0.385
36.58	0.378
46.59	0.297

The transient behavior of the house can be investigated by modeling the constant source being turned off. With this technique, the normalized SPL in a room becomes a measure

of the sound energy decay, as represented in Figure 8. The decay curves appear as straight lines due to the underlying assumption of a perfectly diffuse sound field.

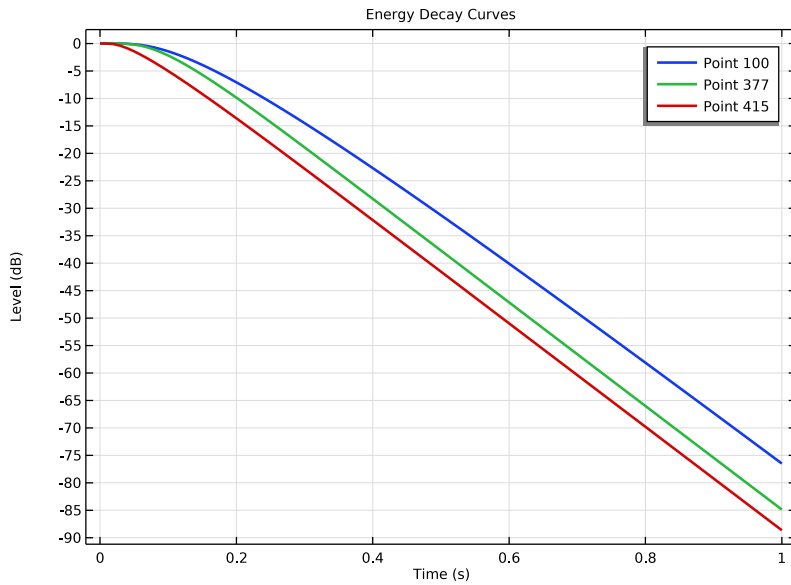

Figure 8: Energy decay curves from three different rooms.

The rays emitted from the two radiating windows are depicted in Figure 9 after 3 ms. This type of plot can be helpful to visually inspect radiation and reflection patterns. In the present case, the hemisphere radiated into appears to be sufficiently sampled. Moreover, the total source power of each window was calculated from the incident power on their inner surface. It is then logical to find that the window closest to the source emits the largest power. The analysis of reflections is, however, limited. The outdoor area next to the

house was modeled as a domain bounded by air and without any obstacle. Therefore, only few reflections at most can happen before a ray disappears into an air boundary.

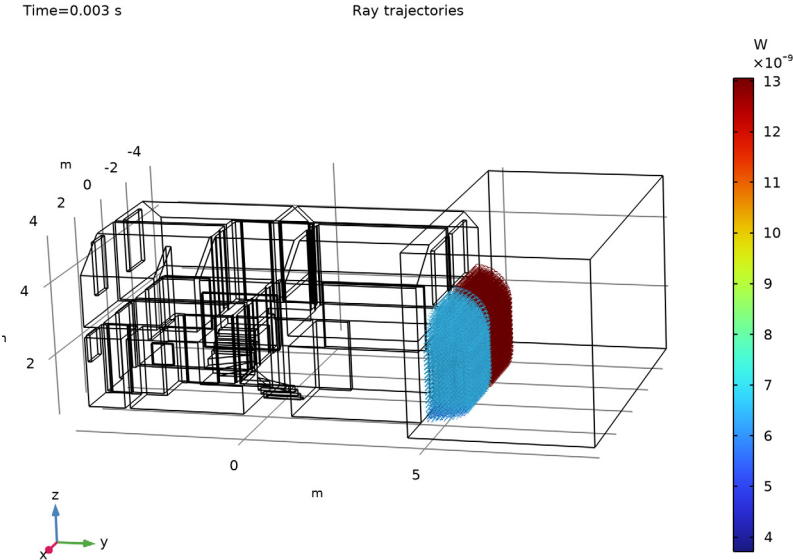

Figure 9: Ray location and power after 3 ms.

The SPL on the ground surface resulting from the window radiation is shown in Figure 10. The SPL on the inner boundaries of the house is also represented for comparison. With the lack of reflections from obstacles, the highest SPL is found in front

of the house at 87 dB. The effect of the transmission loss through the windows is also clearly seen from the large drop between the interior and the exterior of the living room.

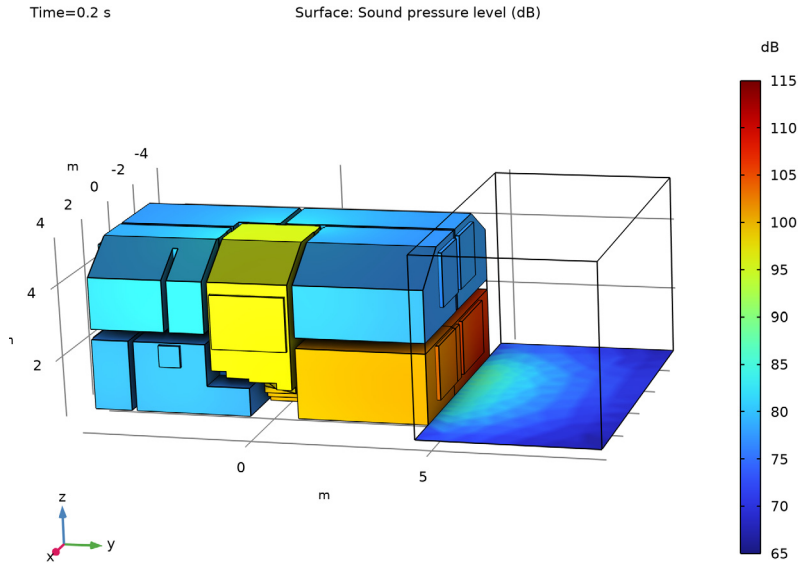

Figure 10: SPL on the house boundaries and on the ground surface outside the house.

Notes About the COMSOL Implementation

The studies in this tutorial were performed for broadband frequency. Nevertheless, the *Acoustic Diffusion Equation* interface allows to set up models in octave bands, 1/3 octave bands, as well as custom bands defined by the user.

The stationary solution computed first was later used as input to a time dependent study and to a ray tracing study. This process is done under **Values of Dependent Variables > Values of variables not solved for** in the study steps by selecting **Settings > User controlled, Method > Solution**, and **Study > Study 1 - Stationary**. Remember to disable all sources in the time-dependent study step by enabling the **Modify physics tree and variables for study step** option, and to disable the *Acoustic Diffusion Equation* interface in the ray tracing study step.

The Release from Boundary feature requires two numbers to determine the emission of rays. The **Number of rays per release** controls the number of points created to discretize the radiating surface. Rays are released from every of these points. Then, the **Number of rays in wave vector space** dictates the number of rays released by each point. As a consequence,

the total number of rays in the feature is the product of these two numbers. For a detailed guide on how to set up the *Ray Acoustics* physics interface in the context of room acoustics see the [Small Concert Hall Acoustics](#) model, also included in the Acoustics Module Application Library.

References

1. R. Schroeder, “New method of measuring reverberation time,” *J. Acoust. Soc. Am.*, vol. 37, pp. 409–412, 1965.
 2. V. Valeau, J. Picaut, and M. Hodgson, “On the use of a diffusion equation for room acoustic prediction,” *J. Acoust. Soc. Am.*, vol. 119, p. 1504, 2006.
 3. T.J. Cox and P. D’Antonio, *Acoustic Absorbers and Diffusers: Theory, design and application*, 2nd ed., Taylor and Francis, 2009.
 4. J. Pujolle, “Les différentes définitions du libre parcours moyen du son dans une salle,” *Revue d’Acoustique*, vol. 36, pp. 44–50, 1976 (in French).
-

Application Library path: Acoustics_Module/Building_and_Room_Acoustics/one_family_house

Modeling Instructions



This section contains the modeling instructions for the model. They are followed by the [Geometry Modeling Instructions](#) section.

From the **File** menu, choose **New**.

NEW

In the **New** window, click  **Model Wizard**.

MODEL WIZARD

- 1 In the **Model Wizard** window, click  **3D**.
- 2 In the **Select Physics** tree, select **Acoustics** > **Geometrical Acoustics** > **Acoustic Diffusion Equation (ade)**.
- 3 Click **Add**.
- 4 Click  **Study**.

5 In the **Select Study** tree, select **General Studies > Stationary**.

6 Click  **Done**.

The geometry is set up by importing a geometry sequence. The sequence imports the one-family house geometry, including parameters for source location and power, and sets up several selections. The predefined selections simplify the rest of the model setup.

GEOMETRY I

1 In the **Geometry** toolbar, click **Insert Sequence** and choose **Insert Sequence**.

2 Browse to the model's Application Libraries folder and double-click the file `one_family_house_geom_sequence.mph`.

Import 1 (impl)

1 In the **Model Builder** window, under **Component 1 (comp1) > Geometry 1** click **Import 1 (impl)**.

2 In the **Settings** window for **Import**, click  **Build Selected**.

3 Click the  **Zoom Extents** button in the **Graphics** toolbar.

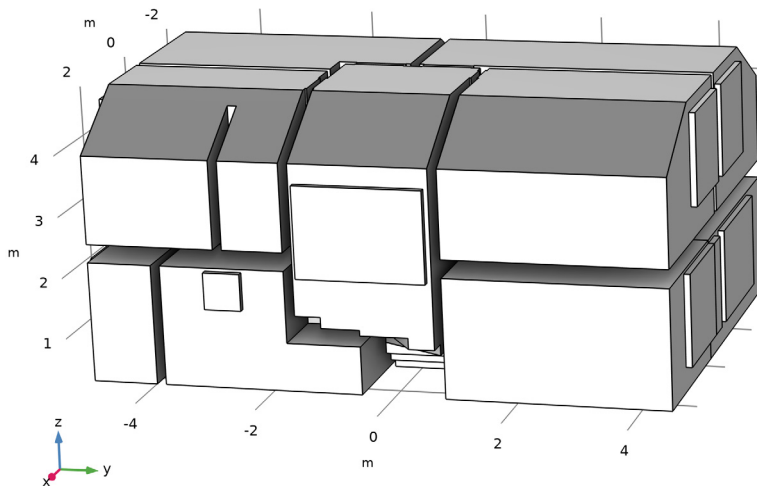

4 In the **Geometry** toolbar, click  **Build All**.

5 Click the  **Wireframe Rendering** button in the **Graphics** toolbar.

GLOBAL DEFINITIONS

Import the model parameters from text files. The parameters include the source location and power, as well as boundary conditions for the surfaces and partitions.



Parameters 1 - Source

The parameters for the source location were defined in the geometry-sequence file. Add a parameter for the source power.



- 1 In the **Model Builder** window, under **Global Definitions** click **Parameters 1**.
- 2 In the **Settings** window for **Parameters**, type Parameters 1 - Source in the **Label** text field.
- 3 Locate the **Parameters** section. In the table, enter the following settings:

Name	Expression	Value	Description
P_s	0.1 [W]	0.1 W	Source power

Parameters 2 - Indoor Boundaries

- 1 In the **Home** toolbar, click  **Parameters** and choose **Add > Parameters**.
- 2 In the **Settings** window for **Parameters**, type Parameters 2 - Indoor Boundaries in the **Label** text field.
- 3 Locate the **Parameters** section. Click  **Load from File**.
- 4 Browse to the model's Application Libraries folder and double-click the file `one_family_house_parameters_indoor.txt`.

ADD MATERIAL

- 1 In the **Materials** toolbar, click  **Add Material** to open the **Add Material** window.
- 2 Go to the **Add Material** window.
- 3 In the tree, select **Built-in > Air**.
- 4 Click the right end of the **Add to Component** split button in the window toolbar.
- 5 From the menu, choose **Add to Component**.
- 6 In the **Materials** toolbar, click  **Add Material** to close the **Add Material** window.

Proceed to set up the physics of the model. Broadband frequency is considered in this case, which is also equivalent to single frequency. Each room is defined with absorption coefficients on its boundaries and a mean free path. The rooms are then coupled with each other by applying transmission loss or sound field continuity on the partitions they have in common.

ACOUSTIC DIFFUSION EQUATION (ADE)

Select Domains 2–12 only.

Room 1

- 1 In the **Model Builder** window, expand the **Acoustic Diffusion Equation (ade)** node, then click **Room 1**.
- 2 In the **Settings** window for **Room**, locate the **Domain Selection** section.
- 3 Click  **Clear Selection**.
- 4 Select Domain 5 only.

Wall 1

- 1 In the **Model Builder** window, expand the **Room 1** node, then click **Wall 1**.
- 2 In the **Settings** window for **Wall**, locate the **Boundary Selection** section.
- 3 From the **Selection** list, choose **All boundaries**.
- 4 Locate the **Wall Absorption Properties** section. In the α text field, type a_wall.

Room 1

In the **Model Builder** window, click **Room 1**.

Wall 2

- 1 In the **Physics** toolbar, click  **Attributes** and choose **Wall**.
- 2 In the **Settings** window for **Wall**, locate the **Boundary Selection** section.
- 3 From the **Selection** list, choose **Windows**.
- 4 Locate the **Wall Absorption Properties** section. In the α text field, type a_window.

Room 1

In the **Model Builder** window, click **Room 1**.

Wall 3

- 1 In the **Physics** toolbar, click  **Attributes** and choose **Wall**.
- 2 In the **Settings** window for **Wall**, locate the **Boundary Selection** section.
- 3 From the **Selection** list, choose **Wooden Floors**.
- 4 Locate the **Wall Absorption Properties** section. In the α text field, type a_floor.

Room 1

In the **Model Builder** window, click **Room 1**.

Wall 4

- 1 In the **Physics** toolbar, click  **Attributes** and choose **Wall**.

- 2 In the **Settings** window for **Wall**, locate the **Boundary Selection** section.
- 3 From the **Selection** list, choose **Ceilings**.
- 4 Locate the **Wall Absorption Properties** section. In the α text field, type `a_ceiling`.

Room 2

- 1 Right-click **Room 1** and choose **Duplicate**.
- 2 In the **Settings** window for **Room**, locate the **Domain Selection** section.
- 3 Click  **Clear Selection**.
- 4 Select Domain 8 only.

Room 3

- 1 Right-click **Room 1** and choose **Duplicate**.
- 2 In the **Settings** window for **Room**, locate the **Domain Selection** section.
- 3 Click  **Clear Selection**.
- 4 Select Domain 7 only.

Wall 3

- 1 In the **Model Builder** window, expand the **Room 3** node, then click **Wall 3**.
- 2 In the **Settings** window for **Wall**, locate the **Boundary Selection** section.
- 3 From the **Selection** list, choose **Stairs**.
- 4 Locate the **Wall Absorption Properties** section. In the α text field, type `a_stairs`.

Room 4

- 1 In the **Model Builder** window, under **Component 1 (comp1) > Acoustic Diffusion Equation (ade)** right-click **Room 1** and choose **Duplicate**.
- 2 In the **Settings** window for **Room**, locate the **Domain Selection** section.
- 3 Click  **Clear Selection**.
- 4 Select Domain 9 only.

Room 5

- 1 Right-click **Room 1** and choose **Duplicate**.
- 2 In the **Settings** window for **Room**, locate the **Domain Selection** section.
- 3 Click  **Clear Selection**.
- 4 Select Domain 4 only.

Room 6

- 1 Right-click **Room 1** and choose **Duplicate**.

- 2 In the **Settings** window for **Room**, locate the **Domain Selection** section.
- 3 Click  **Clear Selection**.
- 4 Select Domains 3 and 10 only.

Room 7

- 1 Right-click **Room 1** and choose **Duplicate**.
- 2 In the **Settings** window for **Room**, locate the **Domain Selection** section.
- 3 Click  **Clear Selection**.
- 4 Select Domain 2 only.

Room 8

- 1 Right-click **Room 1** and choose **Duplicate**.
- 2 In the **Settings** window for **Room**, locate the **Domain Selection** section.
- 3 Click  **Clear Selection**.
- 4 Select Domain 6 only.

Room 9

- 1 Right-click **Room 1** and choose **Duplicate**.
- 2 In the **Settings** window for **Room**, locate the **Domain Selection** section.
- 3 Click  **Clear Selection**.
- 4 Select Domain 12 only.

Room 10

- 1 Right-click **Room 1** and choose **Duplicate**.
- 2 In the **Settings** window for **Room**, locate the **Domain Selection** section.
- 3 Click  **Clear Selection**.
- 4 Select Domain 11 only.

Mapped Room Coupling 1

- 1 In the **Physics** toolbar, click  **Boundaries** and choose **Mapped Room Coupling**.
- 2 In the **Settings** window for **Mapped Room Coupling**, locate the **Boundary Selection** section.
- 3 From the **Selection** list, choose **Door 1**.
- 4 Locate the **Transmission Loss** section. In the **TL** text field, type **TL_heavy**.

Mapped Room Coupling 2

- 1 Right-click **Mapped Room Coupling 1** and choose **Duplicate**.
- 2 In the **Settings** window for **Mapped Room Coupling**, locate the **Boundary Selection** section.

3 From the **Selection** list, choose **Door 2**.

Mapped Room Coupling 3

1 Right-click **Mapped Room Coupling 2** and choose **Duplicate**.

2 In the **Settings** window for **Mapped Room Coupling**, locate the **Boundary Selection** section.

3 From the **Selection** list, choose **Door 3**.

Mapped Room Coupling 4

1 Right-click **Mapped Room Coupling 3** and choose **Duplicate**.

2 In the **Settings** window for **Mapped Room Coupling**, locate the **Boundary Selection** section.

3 From the **Selection** list, choose **Door 4**.

Mapped Room Coupling 5

1 Right-click **Mapped Room Coupling 4** and choose **Duplicate**.

2 In the **Settings** window for **Mapped Room Coupling**, locate the **Boundary Selection** section.

3 From the **Selection** list, choose **Door 5**.

Mapped Room Coupling 6

1 Right-click **Mapped Room Coupling 5** and choose **Duplicate**.

2 In the **Settings** window for **Mapped Room Coupling**, locate the **Boundary Selection** section.

3 From the **Selection** list, choose **Door 6**.

Mapped Room Coupling 7

1 Right-click **Mapped Room Coupling 6** and choose **Duplicate**.

2 In the **Settings** window for **Mapped Room Coupling**, locate the **Boundary Selection** section.

3 From the **Selection** list, choose **Door 7**.

Mapped Room Coupling 8

1 Right-click **Mapped Room Coupling 7** and choose **Duplicate**.

2 In the **Settings** window for **Mapped Room Coupling**, locate the **Boundary Selection** section.

3 From the **Selection** list, choose **Door 8**.

4 Locate the **Transmission Loss** section. In the TL text field, type TL_light.

Mapped Room Coupling 9

1 Right-click **Mapped Room Coupling 8** and choose **Duplicate**.

2 In the **Settings** window for **Mapped Room Coupling**, locate the **Boundary Selection** section.

3 From the **Selection** list, choose **Wall Partition**.

Room Coupling 1

- 1 In the **Physics** toolbar, click  **Boundaries** and choose **Room Coupling**.
- 2 In the **Settings** window for **Room Coupling**, locate the **Boundary Selection** section.
- 3 From the **Selection** list, choose **Door 9**.
- 4 Locate the **Transmission Loss** section. In the TL text field, type TL_light.
- 5 Click to expand the **Continuity** section. Select the **Force continuity** checkbox.

Point Source 1

- 1 In the **Physics** toolbar, click  **Points** and choose **Point Source**.
- 2 Select Point 49 only.
- 3 In the **Settings** window for **Point Source**, locate the **Point Source** section.
- 4 In the q_p text field, type P_s.

Now create a mesh for the model. Geometrical acoustics methods do not require a fine mesh to perform accurately; however, in order to study the sound-pressure level on the different surfaces the element sizes should remain reasonably small.

MESH 1

In the **Model Builder** window, under **Component 1 (comp1)** right-click **Mesh 1** and choose **Build All**.

Proceed to compute the stationary study. Solving the model takes a few seconds.

STUDY 1 - STATIONARY

- 1 In the **Model Builder** window, click **Study 1**.
- 2 In the **Settings** window for **Study**, type Study 1 - Stationary in the **Label** text field.
- 3 In the **Study** toolbar, click  **Compute**.

RESULTS

Sound Pressure Level (ade) - Slices

In the **Settings** window for **3D Plot Group**, type Sound Pressure Level (ade) - Slices in the **Label** text field.

Multislice

- 1 In the **Model Builder** window, expand the **Sound Pressure Level (ade) - Slices** node, then click **Multislice**.
- 2 In the **Settings** window for **Multislice**, locate the **Multiplane Data** section.
- 3 Find the **X-planes** subsection. In the **Planes** text field, type 0.

- 4 Find the **Y-planes** subsection. In the **Planes** text field, type 0.
- 5 Find the **Z-planes** subsection. In the **Planes** text field, type 4.
- 6 In the **Sound Pressure Level (ade) - Slices** toolbar, click  **Plot**.

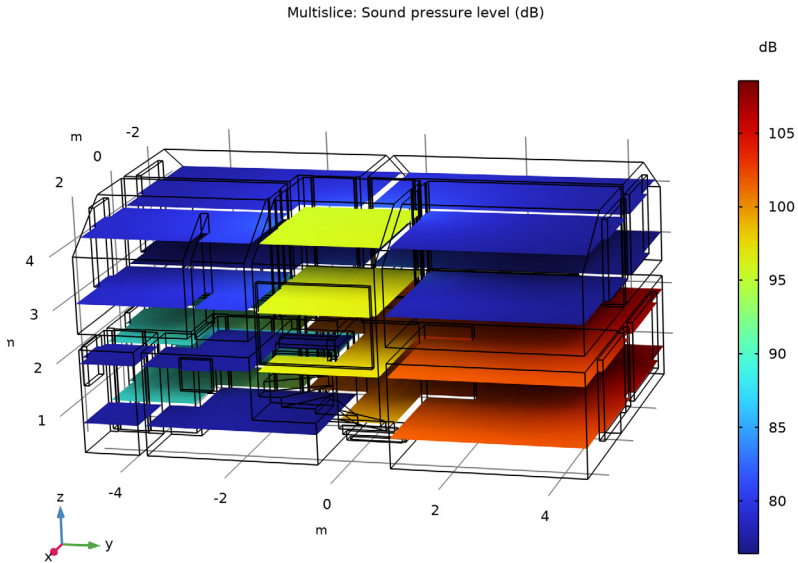

Sound Pressure Level (ade) - Boundaries

- 1 In the **Results** toolbar, click  **3D Plot Group**.
- 2 In the **Settings** window for **3D Plot Group**, type Sound Pressure Level (ade) - Boundaries in the **Label** text field.
- 3 Locate the **Color Legend** section. Select the **Show units** checkbox.

Surface 1

- 1 Right-click **Sound Pressure Level (ade) - Boundaries** and choose **Surface**.
- 2 In the **Settings** window for **Surface**, locate the **Expression** section.
- 3 In the **Expression** text field, type `ade.Lp`.

- 4 In the **Sound Pressure Level (ade) - Boundaries** toolbar, click  **Plot**.

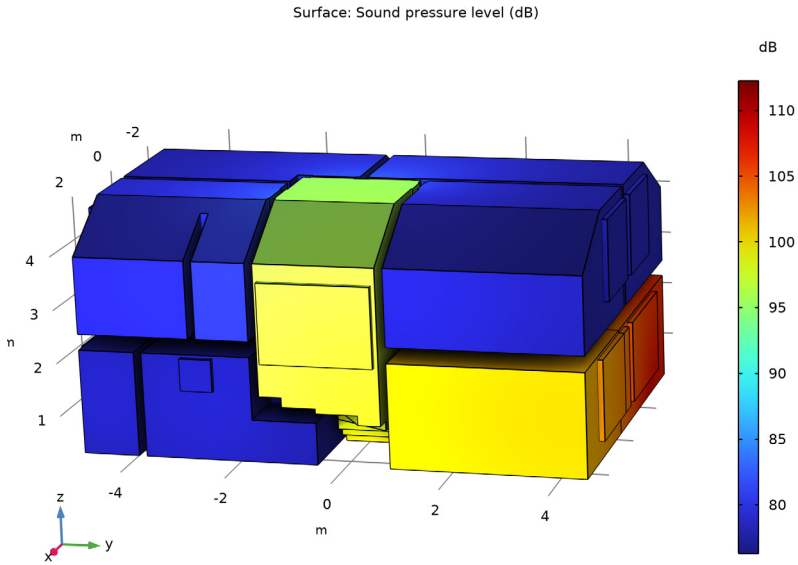

Multislice

- 1 In the **Model Builder** window, expand the **Sound Energy Density (ade)** node, then click **Multislice**.
- 2 In the **Settings** window for **Multislice**, locate the **Multipane Data** section.
- 3 Find the **X-planes** subsection. In the **Planes** text field, type 0.
- 4 Find the **Y-planes** subsection. In the **Planes** text field, type 2.
- 5 Find the **Z-planes** subsection. In the **Planes** text field, type 3.

- 6 In the **Sound Energy Density (ade)** toolbar, click  **Plot**.

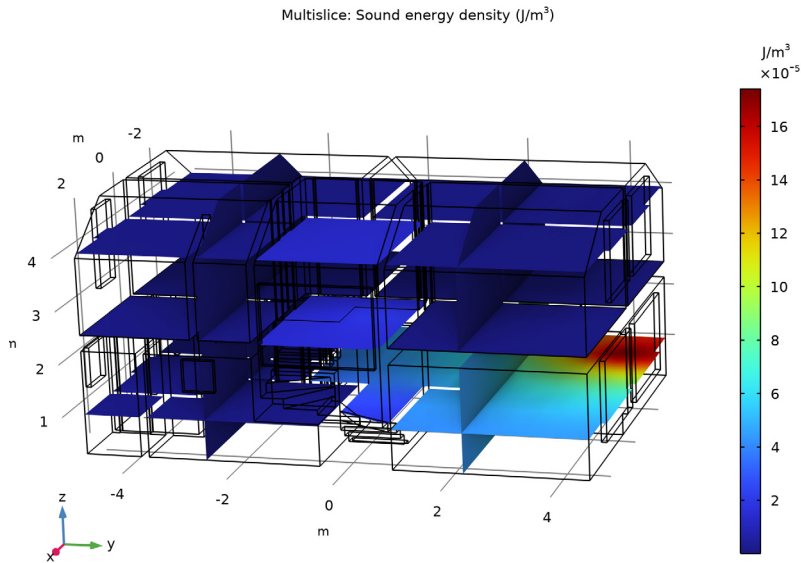

Arrow Volume

- 1 In the **Model Builder** window, expand the **Local Energy Flux (ade)** node.
- 2 Right-click **Arrow Volume** and choose **Disable**.

Streamline I

- 1 In the **Model Builder** window, right-click **Local Energy Flux (ade)** and choose **Streamline**.
- 2 In the **Settings** window for **Streamline**, locate the **Streamline Positioning** section.
- 3 In the **Number** text field, type 100.
- 4 Select Boundaries 66, 68, 133, and 139 only.
- 5 Locate the **Coloring and Style** section. Find the **Line style** subsection. From the **Type** list, choose **Tube**.

Color Expression I

- 1 Right-click **Streamline I** and choose **Color Expression**.
- 2 In the **Settings** window for **Color Expression**, locate the **Expression** section.
- 3 In the **Expression** text field, type $\sqrt{\text{ade} \cdot J_x^2 + \text{ade} \cdot J_y^2 + \text{ade} \cdot J_z^2}$.
- 4 Locate the **Coloring and Style** section. From the **Scale** list, choose **Logarithmic**.

- 5 In the **Local Energy Flux (ade)** toolbar, click  **Plot**.

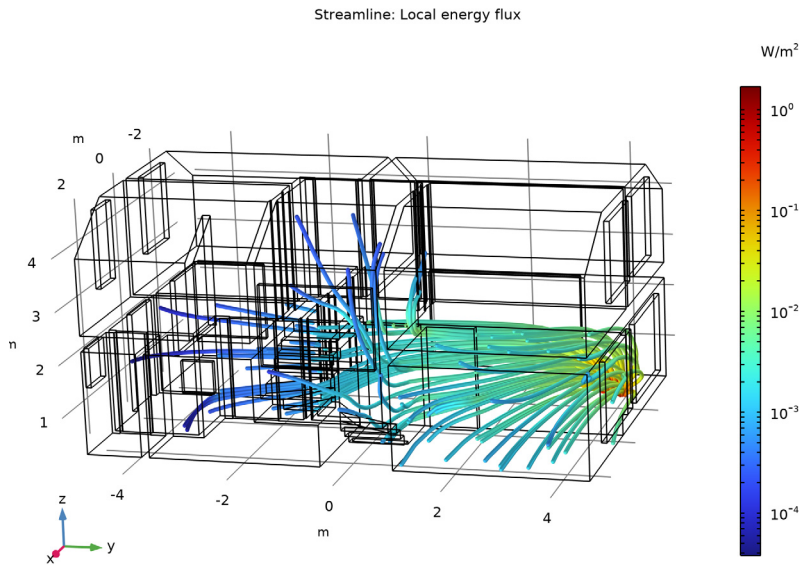

Reverberation Time

- 1 In the **Home** toolbar, click  **Add Plot Group** and choose **3D Plot Group**.
- 2 In the **Settings** window for **3D Plot Group**, type Reverberation Time in the **Label** text field.

Volume I

- 1 Right-click **Reverberation Time** and choose **Volume**.
- 2 In the **Settings** window for **Volume**, locate the **Expression** section.
- 3 In the **Expression** text field, type `ade.T60_EN`.
- 4 Locate the **Coloring and Style** section. From the **Color table** list, choose **AuroraBorealis**.

- 5 In the **Reverberation Time** toolbar, click  **Plot**.

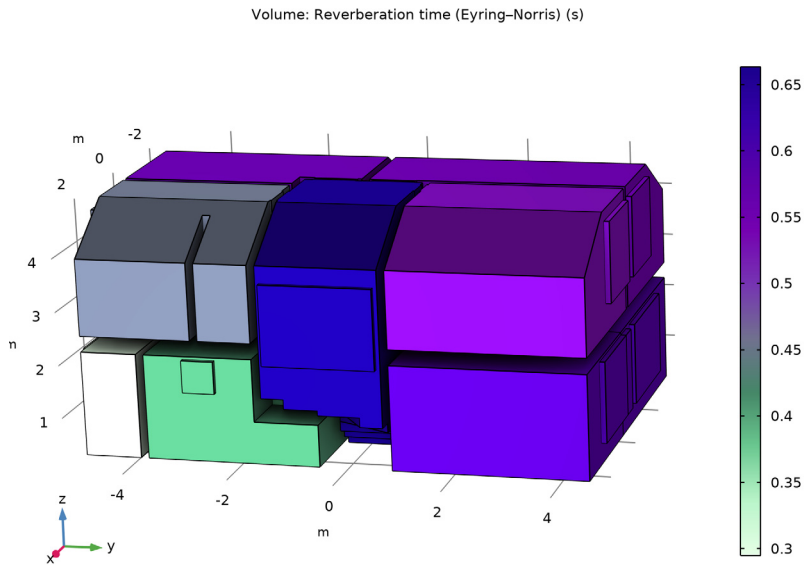

Model Thumbnail

- 1 In the **Results** toolbar, click  **3D Plot Group**.
- 2 In the **Settings** window for **3D Plot Group**, type Model Thumbnail in the **Label** text field.

Streamline 1

- In the **Model Builder** window, under **Results > Local Energy Flux (ade)** right-click **Streamline 1** and choose **Copy**.

Streamline 1

- 1 In the **Model Builder** window, right-click **Model Thumbnail** and choose **Paste Streamline**.
- 2 In the **Settings** window for **Streamline**, locate the **Streamline Positioning** section.
- 3 In the **Number** text field, type 50.

Color Expression 1

- 1 In the **Model Builder** window, expand the **Streamline 1** node, then click **Color Expression 1**.
- 2 In the **Settings** window for **Color Expression**, locate the **Coloring and Style** section.
- 3 Clear the **Color legend** checkbox.

Slice 1

- 1 In the **Model Builder** window, right-click **Model Thumbnail** and choose **Slice**.
- 2 In the **Settings** window for **Slice**, locate the **Expression** section.
- 3 In the **Expression** text field, type `ade.Lp`.
- 4 Locate the **Plane Data** section. From the **Plane** list, choose **XY-planes**.
- 5 From the **Entry method** list, choose **Coordinates**.
- 6 In the **Z-coordinates** text field, type `0.3`.
- 7 Locate the **Coloring and Style** section. Clear the **Color legend** checkbox.

Surface 1

Right-click **Model Thumbnail** and choose **Surface**.

Selection 1

- 1 In the **Model Builder** window, right-click **Surface 1** and choose **Selection**.
- 2 In the **Settings** window for **Selection**, locate the **Selection** section.
- 3 From the **Selection** list, choose **Stairs**.



Surface 1

- 1 In the **Model Builder** window, click **Surface 1**.
- 2 In the **Settings** window for **Surface**, locate the **Expression** section.
- 3 In the **Expression** text field, type `1`.
- 4 Locate the **Coloring and Style** section. Clear the **Color legend** checkbox.
- 5 From the **Coloring** list, choose **Uniform**.
- 6 From the **Color** list, choose **Gray**.

Surface 2

Right-click **Results > Model Thumbnail > Surface 1** and choose **Duplicate**.



Selection 1

- 1 In the **Model Builder** window, expand the **Surface 2** node, then click **Selection 1**.
- 2 In the **Settings** window for **Selection**, locate the **Selection** section.
- 3 Click  **Clear Selection**.
- 4 Click  **Paste Selection**.
- 5 In the **Paste Selection** dialog, type `16, 17, 20, 21, 23, 25, 29, 32, 45, 61, 123, 201` in the **Selection** text field.
- 6 Click **OK**.

7 In the **Model Thumbnail** toolbar, click  **Plot**.

Add and compute an eigenvalue study to investigate the modes in the house and derive associated reverberation times.

ADD STUDY

- 1 In the **Home** toolbar, click  **Add Study** to open the **Add Study** window.
- 2 Go to the **Add Study** window.
- 3 Find the **Studies** subsection. In the **Select Study** tree, select **General Studies** > **Eigenvalue**.
- 4 Click the **Add Study** button in the window toolbar.
- 5 In the **Home** toolbar, click  **Add Study** to close the **Add Study** window.

STUDY 2

Step 1: Eigenvalue

- 1 In the **Settings** window for **Eigenvalue**, locate the **Study Settings** section.
- 2 Select the **Desired number of eigenvalues** checkbox. In the associated text field, type 10.
- 3 Select the **Search for eigenvalues around shift** checkbox.
- 4 From the **Search method around shift** list, choose **Larger real part**.
- 5 In the **Model Builder** window, click **Study 2**.
- 6 In the **Settings** window for **Study**, type Study 2 - Eigenvalue in the **Label** text field.
- 7 In the **Study** toolbar, click  **Compute**.

RESULTS

Sound Energy Density Modes (ade)

- 1 In the **Settings** window for **3D Plot Group**, locate the **Data** section.
- 2 From the **Eigenvalue (rad/s)** list, choose **23.452**.

Multislice

- 1 In the **Model Builder** window, expand the **Sound Energy Density Modes (ade)** node, then click **Multislice**.
- 2 In the **Settings** window for **Multislice**, locate the **Multiplane Data** section.
- 3 Find the **X-planes** subsection. In the **Planes** text field, type 0.
- 4 Find the **Y-planes** subsection. In the **Planes** text field, type 0.
- 5 Find the **Z-planes** subsection. In the **Planes** text field, type 2.

6 In the **Sound Energy Density Modes (ade)** toolbar, click  **Plot**.

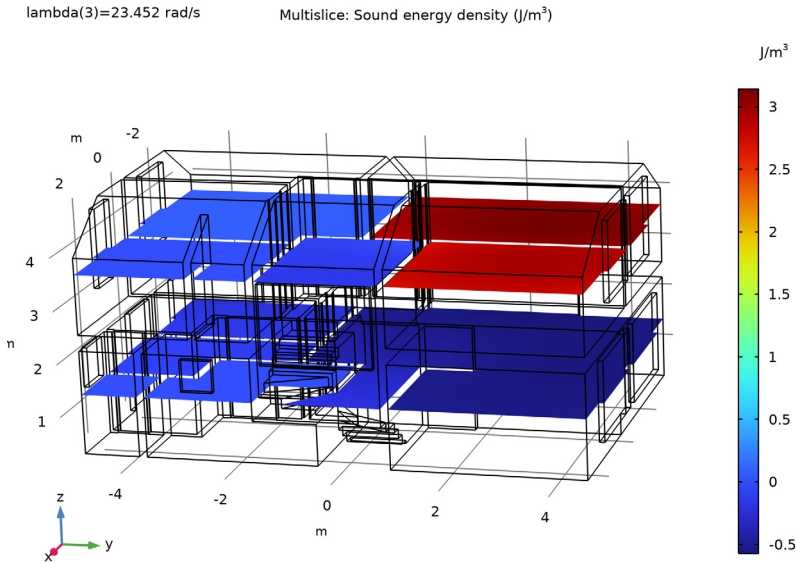



Reverberation Time

- 1 In the **Model Builder** window, under **Results** click **Evaluation Group 1**.
- 2 In the **Settings** window for **Evaluation Group**, type Reverberation Time in the **Label** text field.
- 3 In the **Reverberation Time** toolbar, click  **Evaluate**.

Add a transient study to calculate the energy decay in the different rooms. The solution from Study 1 serves as input to represent a stationary source being turned off at the initial time of the transient study.

ADD STUDY

- 1 In the **Home** toolbar, click  **Add Study** to open the **Add Study** window.
- 2 Go to the **Add Study** window.
- 3 Find the **Studies** subsection. In the **Select Study** tree, select **General Studies** > **Time Dependent**.
- 4 Click the **Add Study** button in the window toolbar.
- 5 In the **Home** toolbar, click  **Add Study** to close the **Add Study** window.

STUDY 3

Step 1: Time Dependent

- 1 In the **Settings** window for **Time Dependent**, locate the **Study Settings** section.
- 2 In the **Output times** text field, type range(0,0.01,1).
- 3 Locate the **Physics and Variables Selection** section. Select the **Modify model configuration for study step** checkbox.
- 4 In the tree, select **Component 1 (comp1) > Acoustic Diffusion Equation (ade) > Point Source 1**.
- 5 Right-click and choose **Disable**.
- 6 Click to expand the **Values of Dependent Variables** section. Find the **Initial values of variables solved for** subsection. From the **Settings** list, choose **User controlled**.
- 7 From the **Method** list, choose **Solution**.
- 8 From the **Study** list, choose **Study 1 - Stationary, Stationary**.
- 9 In the **Model Builder** window, click **Study 3**.
- 10 In the **Settings** window for **Study**, type Study 3 - Transient in the **Label** text field.
- 11 Locate the **Study Settings** section. Clear the **Generate default plots** checkbox.
- 12 In the **Study** toolbar, click  **Compute**.

RESULTS

Energy Decay Curves (normalized)

- 1 In the **Results** toolbar, click  **ID Plot Group**.
- 2 In the **Settings** window for **ID Plot Group**, type Energy Decay Curves (normalized) in the **Label** text field.
- 3 Locate the **Data** section. From the **Dataset** list, choose **Study 3 - Transient/Solution 3 (sol3)**.
- 4 Click to expand the **Title** section. From the **Title type** list, choose **Manual**.
- 5 In the **Title** text area, type Energy Decay Curves.
- 6 Locate the **Plot Settings** section.
- 7 Select the **y-axis label** checkbox. In the associated text field, type Level (dB).

Point Graph 1

- 1 Right-click **Energy Decay Curves (normalized)** and choose **Point Graph**.
- 2 Select Points 100, 377, and 415 only.

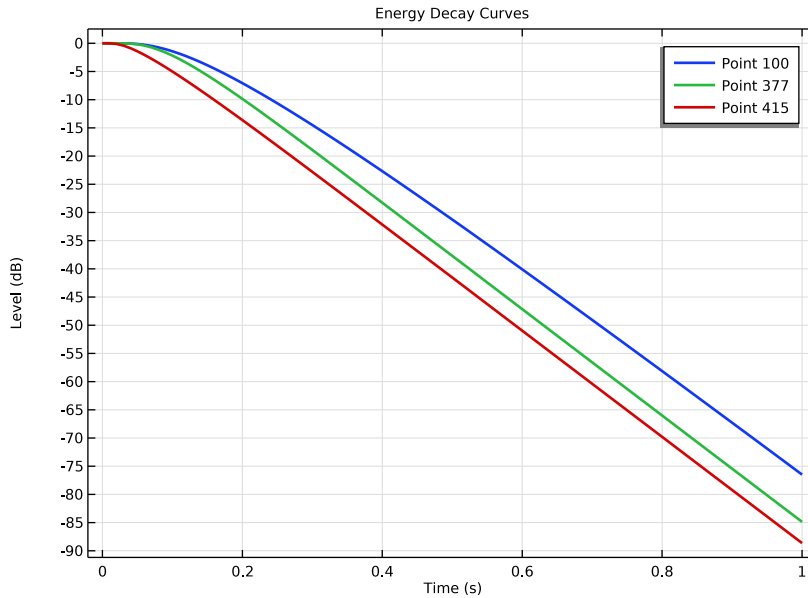

- 3 In the **Settings** window for **Point Graph**, locate the **y-Axis Data** section.
- 4 In the **Expression** text field, type `ade.Lp-with('first',ade.Lp)`.
- 5 Click to expand the **Coloring and Style** section. From the **Width** list, choose **2**.
- 6 Click to expand the **Legends** section. Select the **Show legends** checkbox.
- 7 Find the **Prefix and suffix** subsection. In the **Prefix** text field, type `Point .`
- 8 In the **Energy Decay Curves (normalized)** toolbar, click  **Plot**.



The sound field radiated outside the house can be investigated with the *Ray Acoustics* interface. Start by importing parameters to represent absorption and scattering coefficients in the outdoor domain.

GLOBAL DEFINITIONS

Parameters 3 - Outdoor Boundaries

- 1 In the **Home** toolbar, click  **Parameters** and choose **Add > Parameters**.
- 2 In the **Settings** window for **Parameters**, type `Parameters 3 - Outdoor Boundaries` in the **Label** text field.
- 3 Locate the **Parameters** section. Click  **Load from File**.
- 4 Browse to the model's Application Libraries folder and double-click the file `one_family_house_parameters_outdoor.txt`.

Define the surfaces radiating outward and import the variables to set up the manual coupling between the *Acoustics Diffusion Equation* and *Ray Acoustics* interfaces.

DEFINITIONS

Radiating Window 1

- 1 In the **Definitions** toolbar, click  **Explicit**.
- 2 In the **Settings** window for **Explicit**, type Radiating Window 1 in the **Label** text field.
- 3 Locate the **Input Entities** section. From the **Geometric entity level** list, choose **Boundary**.
- 4 Select Boundary 43 only.

Radiating Window 2

- 1 Right-click **Radiating Window 1** and choose **Duplicate**.
- 2 In the **Settings** window for **Explicit**, type Radiating Window 2 in the **Label** text field.
- 3 Locate the **Input Entities** section. Click  **Clear Selection**.
- 4 Select Boundaries 110 and 146 only.

Integration 1 (intop1)

- 1 In the **Definitions** toolbar, click  **Nonlocal Couplings** and choose **Integration**.
- 2 In the **Settings** window for **Integration**, locate the **Source Selection** section.
- 3 From the **Geometric entity level** list, choose **Boundary**.
- 4 From the **Selection** list, choose **Radiating Window 1**.

Integration 2 (intop2)



- 1 Right-click **Integration 1 (intop1)** and choose **Duplicate**.
- 2 In the **Settings** window for **Integration**, locate the **Source Selection** section.
- 3 From the **Selection** list, choose **Radiating Window 2**.

Variables 1 - Outdoor Radiation

- 1 In the **Model Builder** window, right-click **Definitions** and choose **Variables**.
- 2 In the **Settings** window for **Variables**, type Variables 1 - Outdoor Radiation in the **Label** text field.
- 3 Locate the **Variables** section. Click  **Load from File**.
- 4 Browse to the model's Application Libraries folder and double-click the file `one_family_house_variables_radiation.txt`.

Proceed to set up the physics model. To compute the sound pressure level on surfaces, it is necessary to model the power along the rays.

ADD PHYSICS

- 1 In the **Home** toolbar, click  **Add Physics** to open the **Add Physics** window.
- 2 Go to the **Add Physics** window.
- 3 In the tree, select **Acoustics** > **Geometrical Acoustics** > **Ray Acoustics (rac)**.
- 4 Find the **Physics interfaces in study** subsection. In the table, clear the **Solve** checkboxes for **Study 1 - Stationary**, **Study 2 - Eigenvalue**, and **Study 3 - Transient**.
- 5 Click the **Add to Component 1** button in the window toolbar.
- 6 In the **Home** toolbar, click  **Add Physics** to close the **Add Physics** window.

RAY ACOUSTICS (RAC)

- 1 In the **Settings** window for **Ray Acoustics**, locate the **Domain Selection** section.
- 2 Click  **Clear Selection**.
- 3 Select Domain 1 only.

Medium Properties 1

- 1 In the **Model Builder** window, under **Component 1 (comp1)** > **Ray Acoustics (rac)** click **Medium Properties 1**.
- 2 In the **Settings** window for **Medium Properties**, locate the **Pressure Acoustics Model** section.
- 3 From the **Fluid model** list, choose **Atmosphere attenuation**.
- 4 Locate the **Model Input** section. In the ϕ_w text field, type 0.45.

Set up the sources as radiating surfaces based on the sound power calculated in Study 1.

Release from Boundary 1

- 1 In the **Physics** toolbar, click  **Boundaries** and choose **Release from Boundary**.
Start by selecting the desired surface and defining its discretization. Rays will be released from every point on the surface.
- 2 In the **Settings** window for **Release from Boundary**, locate the **Boundary Selection** section.
- 3 From the **Selection** list, choose **Radiating Window 1**.
- 4 Locate the **Initial Position** section. In the N text field, type 200.
Continue with the radiation direction and the number of rays released by each point.
- 5 Locate the **Ray Direction Vector** section. From the **Ray direction vector** list, choose **Hemispherical**.
- 6 Select the **Specify tangential and normal vector components** checkbox.
- 7 In the N_w text field, type 500.

8 Specify the \mathbf{r} vector as

0	$t1$
0	$t2$
1	n

Finally, enter the source power previously defined in variables.

9 Locate the **Total Source Power** section. In the P_{src} text field, type Prad1.

Release from Boundary 2

- 1 Right-click **Release from Boundary 1** and choose **Duplicate**.
- 2 In the **Settings** window for **Release from Boundary**, locate the **Boundary Selection** section.
- 3 From the **Selection** list, choose **Radiating Window 2**.
- 4 Locate the **Total Source Power** section. In the P_{src} text field, type Prad2.

Wall 2 - Ground

- 1 In the **Physics** toolbar, click  **Boundaries** and choose **Wall**.
- 2 In the **Settings** window for **Wall**, type Wall 2 - Ground in the **Label** text field.
- 3 Select Boundary 3 only.
- 4 Locate the **Wall Condition** section. In the s text field, type 1-s_ground.
- 5 In the α text field, type a_ground.

Sound Pressure Level Calculation 1

In the **Physics** toolbar, click  **Attributes** and choose **Sound Pressure Level Calculation**.

Wall 3 - Exterior Wall

- 1 In the **Physics** toolbar, click  **Boundaries** and choose **Wall**.
- 2 In the **Settings** window for **Wall**, type Wall 3 - Exterior Wall in the **Label** text field.
- 3 Select Boundaries 33–35, 40–42, 51–53, 73, 74, 103–109, 143–145, 175, and 226 only.
- 4 Locate the **Wall Condition** section. In the s text field, type s_extwall.
- 5 In the α text field, type a_extwall.

Wall 4 - Windows

- 1 Right-click **Wall 3 - Exterior Wall** and choose **Duplicate**.
- 2 In the **Settings** window for **Wall**, type Wall 4 - Windows in the **Label** text field.
- 3 Locate the **Boundary Selection** section. Click  **Clear Selection**.



- 4 Select Boundaries 43, 54, 110, 111, and 146 only.
- 5 Locate the **Wall Condition** section. In the *s* text field, type *s_window*.
- 6 In the α text field, type *a_window*.

General Wall 1 - Air

- 1 In the **Physics** toolbar, click  **Boundaries** and choose **General Wall**.
- 2 In the **Settings** window for **General Wall**, type *General Wall 1 - Air* in the **Label** text field.
- 3 Select Boundaries 1, 2, 4, 5, and 259 only.
- 4 Locate the **Wall Condition** section. From the **Wall condition** list, choose **Disappear**.

Proceed with the ray tracing study, setting the results from Study 1 as input.

ADD STUDY

- 1 In the **Home** toolbar, click  **Add Study** to open the **Add Study** window.
- 2 Go to the **Add Study** window.
- 3 Find the **Studies** subsection. In the **Select Study** tree, select **Preset Studies for Selected Physics Interfaces > Ray Acoustics > Ray Tracing**.
- 4 Find the **Physics interfaces in study** subsection. In the table, clear the **Solve** checkbox for **Acoustic Diffusion Equation (ade)**.
- 5 Click the **Add Study** button in the window toolbar.
- 6 In the **Home** toolbar, click  **Add Study** to close the **Add Study** window.

STUDY 4

Step 1: Ray Tracing

- 1 In the **Settings** window for **Ray Tracing**, locate the **Study Settings** section.
- 2 From the **Time unit** list, choose *s*.
- 3 In the **Output times** text field, type *0 0.2*.
- 4 Click to expand the **Values of Dependent Variables** section. Find the **Values of variables not solved for** subsection. From the **Settings** list, choose **User controlled**.
- 5 From the **Method** list, choose **Solution**.
- 6 From the **Study** list, choose **Study 1 - Stationary, Stationary**.
- 7 In the **Model Builder** window, click **Study 4**.
- 8 In the **Settings** window for **Study**, type *Study 4 - Ray Acoustics* in the **Label** text field.

9 In the **Study** toolbar, click  **Compute**.

RESULTS

Ray Trajectories (rac)

- 1 Click the  **Zoom Extents** button in the **Graphics** toolbar.
- 2 In the **Settings** window for **3D Plot Group**, locate the **Data** section.
- 3 From the **Time (s)** list, choose **Interpolation**.
- 4 In the **Time** text field, type 0.003.

Ray Trajectories I

- 1 Click the  **Zoom Extents** button in the **Graphics** toolbar.
- 2 In the **Model Builder** window, expand the **Ray Trajectories (rac)** node, then click **Ray Trajectories I**.
- 3 In the **Settings** window for **Ray Trajectories**, locate the **Coloring and Style** section.
- 4 Find the **Line style** subsection. From the **Type** list, choose **None**.
- 5 Find the **Point style** subsection. From the **Type** list, choose **Point**.

Color Expression I

- 1 In the **Model Builder** window, expand the **Ray Trajectories I** node, then click **Color Expression I**.
- 2 In the **Settings** window for **Color Expression**, locate the **Expression** section.
- 3 In the **Expression** text field, type `rac.Q`.

- 4 In the **Ray Trajectories (rac)** toolbar, click  **Plot**.

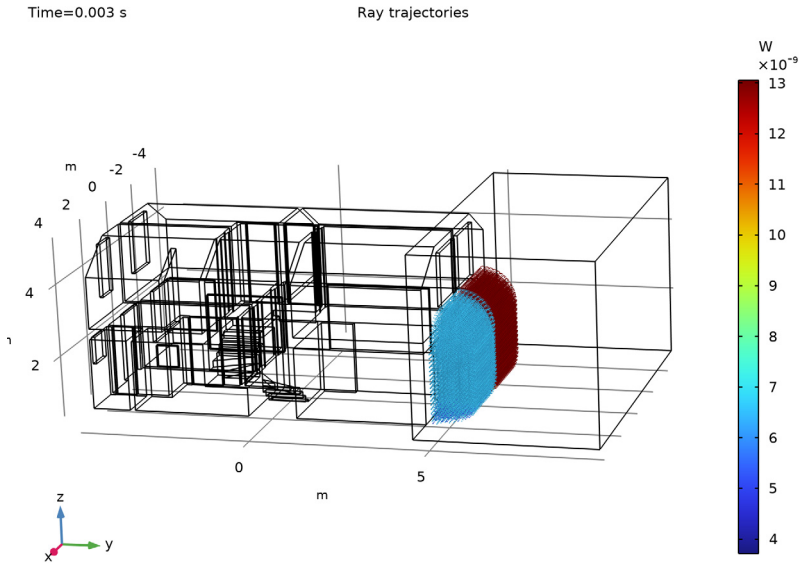

Outdoor SPL

- 1 In the **Results** toolbar, click  **3D Plot Group**.
- 2 In the **Settings** window for **3D Plot Group**, type Outdoor SPL in the **Label** text field.
- 3 Locate the **Data** section. From the **Dataset** list, choose **Study 4 - Ray Acoustics/ Solution 4 (sol4)**.
- 4 Locate the **Color Legend** section. Select the **Show units** checkbox.

Surface 1

- 1 Right-click **Outdoor SPL** and choose **Surface**.
- 2 In the **Settings** window for **Surface**, locate the **Expression** section.
- 3 In the **Expression** text field, type `rac.wall12.sp11.Lp`.
- 4 Click to expand the **Range** section. Select the **Manual color range** checkbox.
- 5 In the **Minimum** text field, type 65.
- 6 In the **Maximum** text field, type 115.

Surface 2

- 1 Right-click **Surface 1** and choose **Duplicate**.
- 2 In the **Settings** window for **Surface**, locate the **Data** section.

- 3 From the **Dataset** list, choose **Study I - Stationary/Solution I (sol1)**.
- 4 Locate the **Expression** section. In the **Expression** text field, type `ade.Lp`.
- 5 Click to expand the **Title** section. From the **Title type** list, choose **None**.
- 6 Locate the **Coloring and Style** section. Clear the **Color legend** checkbox.
- 7 In the **Outdoor SPL** toolbar, click  **Plot**.

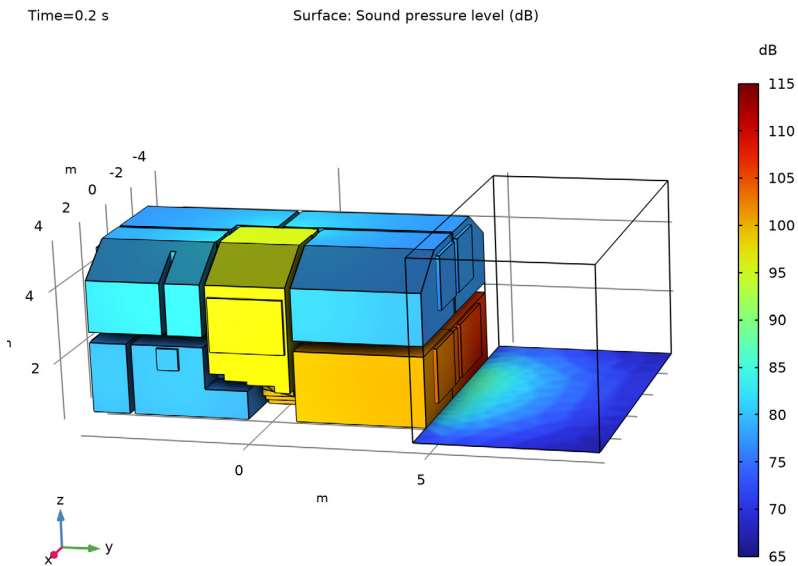

Geometry Modeling Instructions

From the **File** menu, choose **New**.

NEW

In the **New** window, click  **Blank Model**.

GLOBAL DEFINITIONS

Parameters 1

- 1 In the **Model Builder** window, under **Global Definitions** click **Parameters 1**.
- 2 In the **Settings** window for **Parameters**, locate the **Parameters** section.
- 3 Click  **Load from File**.



- 4 Browse to the model's Application Libraries folder and double-click the file `one_family_house_parameters_source.txt`.

ADD COMPONENT

In the **Home** toolbar, click  **Add Component** and choose **3D**.

GEOMETRY I

Import 1 (imp1)

- 1 In the **Geometry** toolbar, click  **Import**.
- 2 In the **Settings** window for **Import**, locate the **Source** section.
- 3 In the **Filename** text field, type `one_family_house.mphbin`.
- 4 Click  **null**.
- 5 Click the  **Wireframe Rendering** button in the **Graphics** toolbar.

Point 1 (pt1)

- 1 In the **Geometry** toolbar, click  **More Primitives** and choose **Point**.
- 2 In the **Settings** window for **Point**, locate the **Point** section.
- 3 In the **x** text field, type `x_s`.
- 4 In the **y** text field, type `y_s`.
- 5 In the **z** text field, type `z_s`.

Block 1 (blk1)



- 1 In the **Geometry** toolbar, click  **Block**.
- 2 In the **Settings** window for **Block**, locate the **Size and Shape** section.
- 3 In the **Width** text field, type 9.
- 4 In the **Depth** text field, type 5.
- 5 In the **Height** text field, type 5.
- 6 Locate the **Position** section. In the **x** text field, type `-4.5`.
- 7 In the **y** text field, type `4.695`.
- 8 In the **z** text field, type `0.3`.

Difference 1 (dif1)



- 1 In the **Geometry** toolbar, click  **Booleans and Partitions** and choose **Difference**.
- 2 Select the object **blk1** only.
- 3 In the **Settings** window for **Difference**, locate the **Difference** section.

- 4 Click to select the  **Activate Selection** toggle button for **Objects to subtract**.
- 5 Select the object **imp1** only.
- 6 Select the **Keep objects to subtract** checkbox.
- 7 Clear the **Keep interior boundaries** checkbox.



Line Segment 1 (Is1)

- 1 In the **Geometry** toolbar, click  **More Primitives** and choose **Line Segment**.
- 2 On the object **dif1**, select Point 6 only.
- 3 In the **Settings** window for **Line Segment**, locate the **Endpoint** section.
- 4 Click to select the  **Activate Selection** toggle button for **End vertex**.
- 5 On the object **dif1**, select Point 7 only.



Line Segment 2 (Is2)

- 1 In the **Geometry** toolbar, click  **More Primitives** and choose **Line Segment**.
- 2 On the object **dif1**, select Point 27 only.
- 3 In the **Settings** window for **Line Segment**, locate the **Endpoint** section.
- 4 Click to select the  **Activate Selection** toggle button for **End vertex**.
- 5 On the object **dif1**, select Point 29 only.



Line Segment 3 (Is3)

- 1 In the **Geometry** toolbar, click  **More Primitives** and choose **Line Segment**.
- 2 On the object **dif1**, select Point 54 only.
- 3 In the **Settings** window for **Line Segment**, locate the **Endpoint** section.
- 4 Click to select the  **Activate Selection** toggle button for **End vertex**.
- 5 On the object **dif1**, select Point 55 only.



Windows

- 1 In the **Geometry** toolbar, click  **Selections** and choose **Explicit Selection**.
- 2 In the **Settings** window for **Explicit Selection**, type Windows in the **Label** text field.
- 3 Locate the **Entities to Select** section. From the **Geometric entity level** list, choose **Boundary**.
- 4 Click the  **Paste Selection** button for **Entities to select**.
- 5 In the **Paste Selection** dialog, type imp1: 1 2 6 37 42 48 104 105 140 156 208 251 252 in the **Selection** text field.
- 6 Click **OK**.



Wooden Floors

- 1 In the **Geometry** toolbar, click  **Selections** and choose **Explicit Selection**.
- 2 In the **Settings** window for **Explicit Selection**, type Wooden Floors in the **Label** text field.
- 3 Locate the **Entities to Select** section. From the **Geometric entity level** list, choose **Boundary**.
- 4 Click the  **Paste Selection** button for **Entities to select**.
- 5 In the **Paste Selection** dialog, type imp1: 8 13 17 26 56 95 118 135 144 191 in the **Selection** text field.
- 6 Click **OK**.



Stairs

- 1 In the **Geometry** toolbar, click  **Selections** and choose **Explicit Selection**.
- 2 In the **Settings** window for **Explicit Selection**, type Stairs in the **Label** text field.
- 3 Locate the **Entities to Select** section. From the **Geometric entity level** list, choose **Boundary**.
- 4 Click the  **Paste Selection** button for **Entities to select**.
- 5 In the **Paste Selection** dialog, type imp1: 82 128-130 153-155 170 171 177 179 180 200 201-203 213-216 221-224 226-234 in the **Selection** text field.
- 6 Click **OK**.

Ceilings

- 1 In the **Geometry** toolbar, click  **Selections** and choose **Explicit Selection**.
- 2 In the **Settings** window for **Explicit Selection**, type Ceilings in the **Label** text field.
- 3 Locate the **Entities to Select** section. From the **Geometric entity level** list, choose **Boundary**.
- 4 Click the  **Paste Selection** button for **Entities to select**.
- 5 In the **Paste Selection** dialog, type imp1: 14 18 22 27 39 40 57 83 96 119 136 145 186-188 192 in the **Selection** text field.
- 6 Click **OK**.

Door 1



- 1 In the **Geometry** toolbar, click  **Selections** and choose **Explicit Selection**.
- 2 In the **Settings** window for **Explicit Selection**, type Door 1 in the **Label** text field.
- 3 Locate the **Entities to Select** section. From the **Geometric entity level** list, choose **Boundary**.
- 4 Click the  **Paste Selection** button for **Entities to select**.

- 5 In the **Paste Selection** dialog, type imp1: 107 109 in the **Selection** text field.
- 6 Click **OK**.
- 7 Right-click **Door 1** and choose **Group**.



Room Separations

In the **Settings** window for **Group**, type Room Separations in the **Label** text field.



Door 2

- 1 In the **Geometry** toolbar, click  **Selections** and choose **Explicit Selection**.
- 2 In the **Settings** window for **Explicit Selection**, type Door 2 in the **Label** text field.
- 3 Locate the **Entities to Select** section. From the **Geometric entity level** list, choose **Boundary**.
- 4 Click the  **Paste Selection** button for **Entities to select**.
- 5 In the **Paste Selection** dialog, type imp1: 79 85 in the **Selection** text field.
- 6 Click **OK**.

Door 3

- 1 In the **Geometry** toolbar, click  **Selections** and choose **Explicit Selection**.
- 2 In the **Settings** window for **Explicit Selection**, type Door 3 in the **Label** text field.
- 3 Locate the **Entities to Select** section. From the **Geometric entity level** list, choose **Boundary**.
- 4 Click the  **Paste Selection** button for **Entities to select**.
- 5 In the **Paste Selection** dialog, type imp1: 78 80 in the **Selection** text field.
- 6 Click **OK**.

Door 4



- 1 In the **Geometry** toolbar, click  **Selections** and choose **Explicit Selection**.
- 2 In the **Settings** window for **Explicit Selection**, type Door 4 in the **Label** text field.
- 3 Locate the **Entities to Select** section. From the **Geometric entity level** list, choose **Boundary**.
- 4 Click the  **Paste Selection** button for **Entities to select**.
- 5 In the **Paste Selection** dialog, type imp1: 162 164 in the **Selection** text field.
- 6 Click **OK**.

Door 5



- 1 In the **Geometry** toolbar, click  **Selections** and choose **Explicit Selection**.

- 2 In the **Settings** window for **Explicit Selection**, type Door 5 in the **Label** text field.
- 3 Locate the **Entities to Select** section. From the **Geometric entity level** list, choose **Boundary**.
- 4 Click the  **Paste Selection** button for **Entities to select**.
- 5 In the **Paste Selection** dialog, type imp1: 141 142 in the **Selection** text field.
- 6 Click **OK**.



Door 6

- 1 In the **Geometry** toolbar, click  **Selections** and choose **Explicit Selection**.
- 2 In the **Settings** window for **Explicit Selection**, type Door 6 in the **Label** text field.
- 3 Locate the **Entities to Select** section. From the **Geometric entity level** list, choose **Boundary**.
- 4 Click the  **Paste Selection** button for **Entities to select**.
- 5 In the **Paste Selection** dialog, type imp1: 31 33 in the **Selection** text field.
- 6 Click **OK**.

Door 7

- 1 In the **Geometry** toolbar, click  **Selections** and choose **Explicit Selection**.
- 2 In the **Settings** window for **Explicit Selection**, type Door 7 in the **Label** text field.
- 3 Locate the **Entities to Select** section. From the **Geometric entity level** list, choose **Boundary**.
- 4 Click the  **Paste Selection** button for **Entities to select**.
- 5 In the **Paste Selection** dialog, type imp1: 185 189 in the **Selection** text field.
- 6 Click **OK**.

Door 8



- 1 In the **Geometry** toolbar, click  **Selections** and choose **Explicit Selection**.
- 2 In the **Settings** window for **Explicit Selection**, type Door 8 in the **Label** text field.
- 3 Locate the **Entities to Select** section. From the **Geometric entity level** list, choose **Boundary**.
- 4 Click the  **Paste Selection** button for **Entities to select**.
- 5 In the **Paste Selection** dialog, type imp1: 60 62 in the **Selection** text field.
- 6 Click **OK**.

Door 9

- 1 In the **Geometry** toolbar, click  **Selections** and choose **Explicit Selection**.

- 2 In the **Settings** window for **Explicit Selection**, type Door 9 in the **Label** text field.
- 3 Locate the **Entities to Select** section. From the **Geometric entity level** list, choose **Boundary**.
- 4 Click the  **Paste Selection** button for **Entities to select**.
- 5 In the **Paste Selection** dialog, type imp1: 127 in the **Selection** text field.
- 6 Click **OK**.

Wall Partition

- 1 In the **Geometry** toolbar, click  **Selections** and choose **Explicit Selection**.
- 2 In the **Settings** window for **Explicit Selection**, type Wall Partition in the **Label** text field.
- 3 Locate the **Entities to Select** section. From the **Geometric entity level** list, choose **Boundary**.
- 4 Click the  **Paste Selection** button for **Entities to select**.
- 5 In the **Paste Selection** dialog, type imp1: 76 93 in the **Selection** text field.
- 6 Click **OK**.
- 7 In the **Geometry** toolbar, click  **Build All**.