



Model created in COMSOL Multiphysics 6.4

Ultrasonic Flowmeter with Piezoelectric Transducers

Introduction

Ultrasonic flowmeters are used to determine the velocity of the fluid flowing through a pipe. The principle is to send an ultrasonic signal across the flow at a skew angle. In case of no flow, the transmitting time between the transmitter and the receiver is the same for the signals sent in the upstream and the downstream directions. Otherwise, the downstream traveling wave moves faster than the one traveling upstream. In many cases piezoelectric transducers are used to send and receive the ultrasonic wave.

This tutorial shows how to simulate an ultrasonic flowmeter with piezoelectric transducers in the presence of a background flow. The simulation approach is based on the discontinuous Galerkin (dG) method which is well suited for acoustically large transient problems. The model is a true multiphysics problem that involves acoustic-structure interaction in moving fluids and piezoelectric effect. The former is modeled with the Elastic Waves, Time Explicit and the Convected Wave Equation, Time Explicit physics interfaces coupled through the Pair Convected Acoustic–Structure Boundary, Time Explicit multiphysics feature. The latter is handled with the Piezoelectric Effect, Time Explicit multiphysics feature that couples the Elastic Waves, Time Explicit and the Electrostatics physics interfaces. The model takes advantage of a geometry assembly and a nonconforming mesh.

Model Definition

The flowmeter consists of a main pipe and a signal pipe of a smaller diameter. The signal tube is tilted to the main pipe at the angle $\alpha = 45^\circ$. The dimensions of the pipes used in this tutorial are the same as the ones given in the model [Ultrasound Flowmeter with Generic Time-of-Flight Configuration](#). The pipe walls are considered rigid. There are two transducers placed at either end of the signal pipe. They operate as a transmitter and a receiver. Both transducers are identical and consist of a piezoelectric unit, a matching layer, and a damping block. An input voltage signal applied to the transmitter results in the mechanical deformation of the piezoelectric transducer, which is due to the inverse piezoelectric effect. The mechanical deformation in its turn generates an acoustic wave in the fluid. When the acoustic wave reaches the receiver, the inverse process takes place: the mechanical load is being converted into an electric signal because of the direct piezoelectric effect.

As previously mentioned, this model studies the propagation of the acoustic wave in the presence of a background flow. The details of the background flow computation and the flow speed estimation using the time-of-flight method are given in the model [Ultrasound Flowmeter with Generic Time-of-Flight Configuration](#) and thus not repeated here. The

focus of this tutorial lies on the acoustic interaction between the fluid and the solid and the conversion *input electric signal – acoustic wave in moving fluid – output electric signal*. This model solves the full three-dimensional problem with the symmetry condition imposed on the sagittal plane of the structure.

The transmitter and the receiver can be used interchangeably; therefore, the principles of their construction are the same. The main part is a disk made of a piezoelectric material (here, PZT-5H) that is used for the conversion between the electric and the mechanical waves. Its thickness is taken to be 1/2 of the wavelength.

A direct propagation of the acoustic wave from the piezoelectric material to the fluid will result in significant reflections from the solid/fluid interface and, consequently, losses. This is due to the impedance mismatch: for water, the characteristic acoustic impedance $Z_{\text{water}} \approx 1.5$ MRayl, and for PZT-5H, $Z_{\text{PZT}} \approx 34,5$ MRayl. Therefore, a 1/4 wavelength thick matching layer is required to minimize the losses. Its impedance should be close to the geometric mean of those of the piezoelectric and the fluid materials, that is

$$Z_{\text{match}} = \sqrt{Z_{\text{water}} Z_{\text{PZT}}} \approx 7,2 \text{ MRayl.}$$

The piezoelectric element is surrounded by a backing layer block (also called damping block) at the back. The damping block absorbs the waves radiated from the back face of the piezoelectric element. The properties of the used matching and damping materials are shown in [Table 1](#).

TABLE 1: MATCHING AND DAMPING MATERIAL PROPERTIES.

Part	Material	Density, kg/m ³	Longitudinal wave speed, m/s	Shear wave speed, m/s
Matching layer	Alumina/Epoxy	2280	3400	1920
Damping block	Tungsten/Epoxy	6580	1500	775

The input signal applied to the transmitter is a harmonic voltage pulse of the amplitude $V_0 = 50$ V, the frequency $f_0 = 2.5$ MHz, and duration of 2 μ s. The voltage profile is depicted in [Figure 1](#).

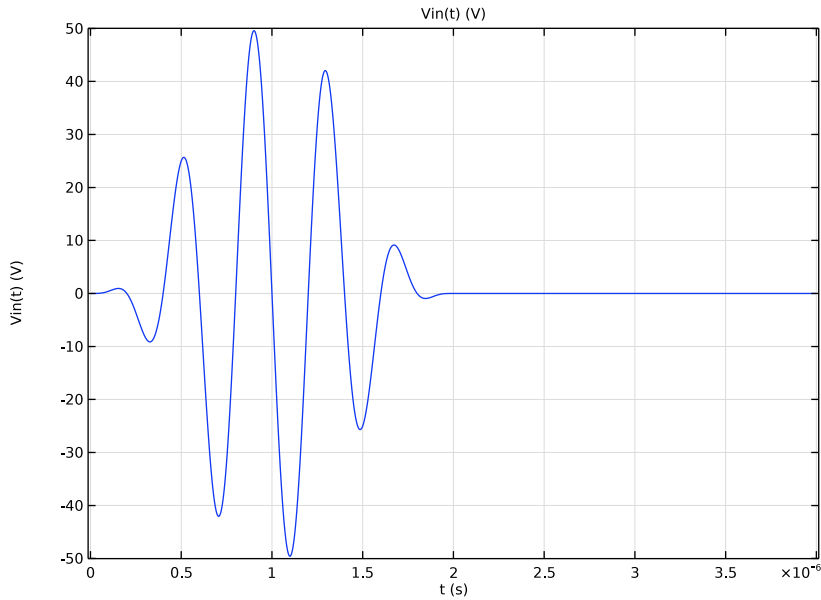

Figure 1: Input voltage applied to the transmitter.

Results and Discussion

The computed background fluid flow and the profiles of the acoustic pressure wave in solid and fluid domains are shown in [Figure 2](#) and [Figure 3](#). The signal emitted by the transmitter propagates into the fluid at $t = 4 \mu\text{s}$ (upper-left corner). The signal reaches the upper wall of the main pipe at $t = 6 \mu\text{s}$ (upper-right corner) and propagates further in the signal pipe to the receiver at $t = 8 \mu\text{s}$ (lower-left corner). The signal reaches the end of the signal tube and generates an elastic wave in the receiver at $t = 10 \mu\text{s}$ (lower-right corner).

The elastic wave in the receiver piezoelectric element is converted into an electric signal. In [Figure 4](#) you can see the profiles of the input voltage applied to the transducer and the output electric signal read on the receiver.

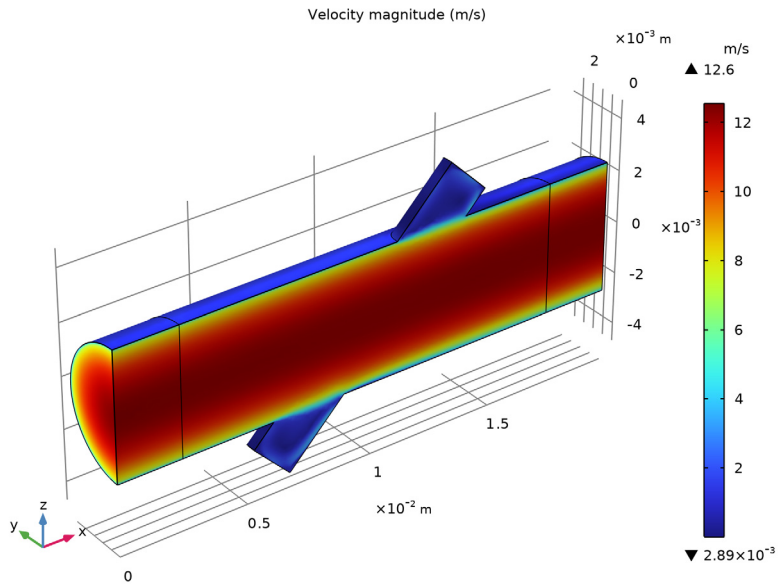

Figure 2: Background mean flow magnitude in the flowmeter.

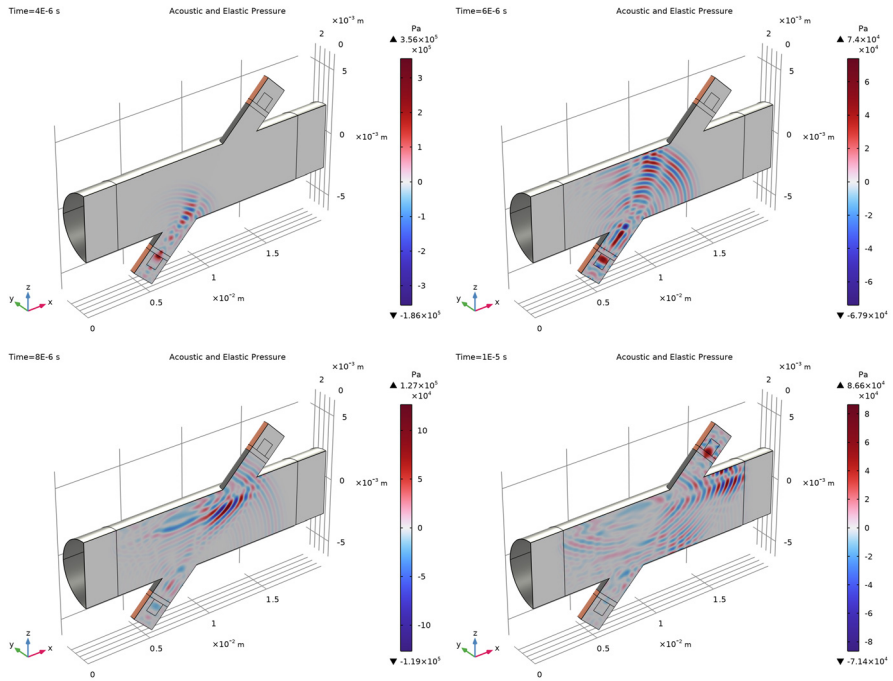

Figure 3: Propagation of the acoustic pressure signal at four time steps.

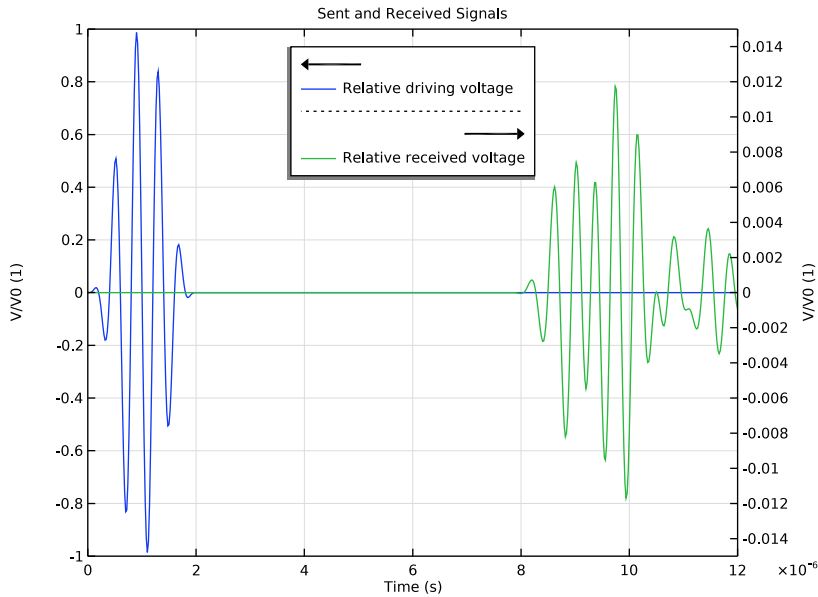

Figure 4: Input and output electric signals as functions of time.

Notes About the COMSOL Implementation

GEOMETRY AND MESH

The model geometry is an assembly and therefore parts of the geometry are separated from one another and connected via *Identity Boundary Pairs*. The nodes of the generated mesh elements do not have to match on either side for the pairs thus making the mesh nonconformal. For wave propagation problems, feasible results are achieved when the mesh resolves the wavelengths of the propagating waves. In the solid domains, the minimal wavelength is given by the shear wave speed. Thus materials with lower speed of sound require finer mesh than those with higher speed of sound (compare the shear wave speeds for the matching and the damping material given in Table 1). The use of a nonconformal mesh in this tutorial makes it possible to reduce the number of DOFs solved for in the model.

Application Library path: Acoustics_Module/Ultrasound/
flow_meter_piezoelectric_transducers



Modeling Instructions

From the **File** menu, choose **New**.

NEW

In the **New** window, click  **Model Wizard**.

MODEL WIZARD

- 1 In the **Model Wizard** window, click .
- 2 Click  **Done**.

GEOMETRY I



Load the parameters that define the geometry and the physical properties of the system.

GLOBAL DEFINITIONS

Geometry Parameters



- 1 In the **Model Builder** window, under **Global Definitions** click **Parameters I**.
- 2 In the **Settings** window for **Parameters**, locate the **Parameters** section.
- 3 Click  **Load from File**.
- 4 Browse to the model's Application Libraries folder and double-click the file `flow_meter_piezoelectric_transducers_geometry_parameters.txt`.
- 5 In the **Label** text field, type Geometry Parameters.

Model Parameters

- 1 In the **Home** toolbar, click  **Parameters** and choose **Add > Parameters**.
- 2 In the **Settings** window for **Parameters**, locate the **Parameters** section.
- 3 Click  **Load from File**.
- 4 Browse to the model's Application Libraries folder and double-click the file `flow_meter_piezoelectric_transducers_model_parameters.txt`.
- 5 In the **Label** text field, type Model Parameters.

Import the model geometry sequence from the geometry file. The instructions to the geometry are found in the appendix at the end of this document.

GEOMETRY I

- 1 In the **Geometry** toolbar, click  **Insert Sequence**.
- 2 Browse to the model's Application Libraries folder and double-click the file `flow_meter_piezoelectric_transducers_geom_sequence.mph`.
- 3 In the **Geometry** toolbar, click  **Build All**.
- 4 In the **Model Builder** window, under **Component 1 (comp1)** click **Geometry 1**.

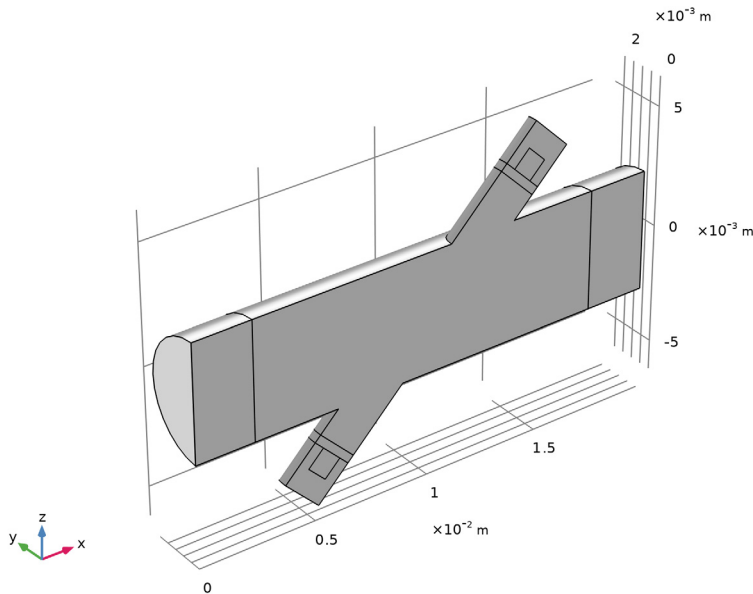

Specify the driving voltage signal applied to the transmitter.

GLOBAL DEFINITIONS

Rectangle 1 (rect1)

- 1 In the **Home** toolbar, click  **Functions** and choose **Global > Rectangle**.
- 2 In the **Settings** window for **Rectangle**, locate the **Parameters** section.
- 3 In the **Lower limit** text field, type `0.5e-6`.
- 4 In the **Upper limit** text field, type `1.5e-6`.

5 Click to expand the **Smoothing** section. In the **Size of transition zone** text field, type 1e-6.

6 Click  **Plot**.

Analytic 1 (an1)

1 In the **Home** toolbar, click  **Functions** and choose **Global > Analytic**.

2 In the **Settings** window for **Analytic**, type *V* in the **Function name** text field.

3 Locate the **Definition** section. In the **Expression** text field, type $V0*\sin(2*\pi*f0*t)*\text{rect1}(t)$.

4 In the **Arguments** text field, type *t*.

5 Locate the **Units** section. In the **Function** text field, type *V*.

6 In the table, enter the following settings:

Argument	Unit
<i>t</i>	s

7 Locate the **Plot Parameters** section. In the table, enter the following settings:

Plot	Argument	Lower limit	Upper limit	Fixed value	Unit
$\sqrt{\quad}$	<i>t</i>	0	10*T0	0	s

8 Click  **Plot**.

The input electric signal should look like the one in [Figure 1](#).

Create selections to simplify the model setup.

DEFINITIONS

Water

1 In the **Definitions** toolbar, click  **Explicit**.

2 Select Domains 1–3 only.

3 In the **Settings** window for **Explicit**, type *Water* in the **Label** text field.

PZT

1 In the **Definitions** toolbar, click  **Explicit**.

2 Select Domains 5 and 9 only.

3 In the **Settings** window for **Explicit**, type *PZT* in the **Label** text field.

Matching

- 1 In the **Definitions** toolbar, click  **Explicit**.
- 2 Select Domains 6 and 7 only.
- 3 In the **Settings** window for **Explicit**, type Matching in the **Label** text field.

Backing

- 1 In the **Definitions** toolbar, click  **Explicit**.
- 2 Select Domains 4 and 8 only.
- 3 In the **Settings** window for **Explicit**, type Backing in the **Label** text field.

Symmetry

- 1 In the **Definitions** toolbar, click  **Explicit**.
- 2 In the **Settings** window for **Explicit**, locate the **Input Entities** section.
- 3 From the **Geometric entity level** list, choose **Boundary**.
- 4 Select Boundaries 2, 6, 16, 22, 30, 33, 40, 46, and 55 only.
- 5 In the **Label** text field, type Symmetry.

Flow Inlet

- 1 In the **Definitions** toolbar, click  **Explicit**.
- 2 In the **Settings** window for **Explicit**, locate the **Input Entities** section.
- 3 From the **Geometric entity level** list, choose **Boundary**.
- 4 Select Boundary 1 only.
- 5 In the **Label** text field, type Flow Inlet.

Flow Outlet

- 1 In the **Definitions** toolbar, click  **Explicit**.
- 2 In the **Settings** window for **Explicit**, locate the **Input Entities** section.
- 3 From the **Geometric entity level** list, choose **Boundary**.
- 4 Select Boundary 19 only.
- 5 In the **Label** text field, type Flow Outlet.

Solid

- 1 In the **Definitions** toolbar, click  **Union**.
- 2 In the **Settings** window for **Union**, type Solid in the **Label** text field.
- 3 Locate the **Input Entities** section. Under **Selections to add**, click **+** **Add**.
- 4 In the **Add** dialog, in the **Selections to add** list, choose **PZT**, **Matching**, and **Backing**.

5 Click **OK**.

Define a coordinate system that corresponds to the piezoelectric material orientation: the *Z*-axis of the piezoelectric crystal points along the signal tube axis.

Transducer Coordinate System

- 1 In the **Definitions** toolbar, click  **Coordinate Systems** and choose **Base Vector System**.
- 2 In the **Settings** window for **Base Vector System**, locate the **Base Vectors** section.
- 3 In the table, enter the following settings:

	x	y	z
x1	cos(alpha)	0	-sin(alpha)
x3	sin(alpha)	0	cos(alpha)

- 4 Find the **Simplifications** subsection. Select the **Assume orthonormal** checkbox.
- 5 In the **Label** text field, type *Transducer Coordinate System*.

Now, proceed to setting up the physics. Note that the model geometry is an assembly and therefore each physics interface automatically imposes the **Continuity** boundary condition on all boundary pairs.

ADD PHYSICS

- 1 In the **Home** toolbar, click  **Add Physics** to open the **Add Physics** window.
- 2 Go to the **Add Physics** window.
- 3 In the tree, select **Fluid Flow** > **Single-Phase Flow** > **Turbulent Flow** > **Turbulent Flow, k- ω (spf)**.
- 4 Click the **Add to Selection** button in the window toolbar.

TURBULENT FLOW, K- ω (SPF)

- 1 In the **Settings** window for **Turbulent Flow, k- ω** , locate the **Domain Selection** section.
- 2 From the **Selection** list, choose **Water**.

Inlet 1

- 1 In the **Physics** toolbar, click  **Boundaries** and choose **Inlet**.
- 2 In the **Settings** window for **Inlet**, locate the **Boundary Selection** section.
- 3 From the **Selection** list, choose **Flow Inlet**.
- 4 Locate the **Boundary Condition** section. From the list, choose **Fully developed flow**.

- 5 Locate the **Fully Developed Flow** section. In the U_{av} text field, type U_{in} .
This boundary condition ensures a fully developed turbulent flow profile at the inlet.

Outlet 1

- 1 In the **Physics** toolbar, click  **Boundaries** and choose **Outlet**.
- 2 In the **Settings** window for **Outlet**, locate the **Boundary Selection** section.
- 3 From the **Selection** list, choose **Flow Outlet**.

Symmetry 1

- 1 In the **Physics** toolbar, click  **Boundaries** and choose **Symmetry**.
- 2 In the **Settings** window for **Symmetry**, locate the **Boundary Selection** section.
- 3 From the **Selection** list, choose **Symmetry**.

Flow Continuity 1

- 1 In the **Model Builder** window, click **Flow Continuity 1**.
- 2 In the **Settings** window for **Flow Continuity**, locate the **Advanced** section.
- 3 Select the **Disconnect pair** checkbox.

ADD PHYSICS

- 1 Go to the **Add Physics** window.
- 2 In the tree, select **Acoustics** > **Ultrasound** > **Convected Wave Equation, Time Explicit (cwe)**.
- 3 Click the **Add to Selection** button in the window toolbar.

CONVECTED WAVE EQUATION, TIME EXPLICIT (CWE)

- 1 In the **Settings** window for **Convected Wave Equation, Time Explicit**, locate the **Domain Selection** section.
- 2 From the **Selection** list, choose **Water**.
- 3 In the **Model Builder** window, click **Convected Wave Equation, Time Explicit (cwe)**.

Specific Acoustic Impedance (Isentropic) 1

- 1 In the **Physics** toolbar, click  **Boundaries** and choose **Specific Acoustic Impedance (Isentropic)**.
- 2 Select Boundaries 1 and 19 only.

Symmetry 1

- 1 In the **Physics** toolbar, click  **Boundaries** and choose **Symmetry**.
- 2 In the **Settings** window for **Symmetry**, locate the **Boundary Selection** section.
- 3 From the **Selection** list, choose **Symmetry**.

ADD PHYSICS

- 1 Go to the **Add Physics** window.
- 2 In the tree, select **Acoustics > Elastic Waves > Elastic Waves, Time Explicit (elte)**.
- 3 Click the **Add to Selection** button in the window toolbar.

ELASTIC WAVES, TIME EXPLICIT (ELTE)

- 1 In the **Settings** window for **Elastic Waves, Time Explicit**, locate the **Domain Selection** section.
- 2 From the **Selection** list, choose **Solid**.

Piezoelectric Material I

Right-click **Component 1 (comp1) > Elastic Waves, Time Explicit (elte)** and choose **Piezoelectric Material**.

Elastic Waves, Time Explicit Model I

- 1 In the **Settings** window for **Elastic Waves, Time Explicit Model**, locate the **Linear Elastic Material** section.
- 2 From the **Specify** list, choose **Pressure-wave and shear-wave speeds**.

Piezoelectric Material I

- 1 In the **Model Builder** window, click **Piezoelectric Material I**.
- 2 In the **Settings** window for **Piezoelectric Material**, locate the **Domain Selection** section.
- 3 From the **Selection** list, choose **PZT**.
- 4 Locate the **Coordinate System Selection** section. From the **Coordinate system** list, choose **Transducer Coordinate System (sys2)**.

Low-Reflecting Boundary I

- 1 In the **Physics** toolbar, click  **Boundaries** and choose **Low-Reflecting Boundary**.
- 2 Select Boundaries 21 and 52 only.

Symmetry I

- 1 In the **Physics** toolbar, click  **Boundaries** and choose **Symmetry**.
- 2 In the **Settings** window for **Symmetry**, locate the **Boundary Selection** section.
- 3 From the **Selection** list, choose **Symmetry**.

Elastic Waves, Time Explicit Model I

In the **Model Builder** window, click **Elastic Waves, Time Explicit Model I**.

Damping 1

- 1 In the **Physics** toolbar, click  **Attributes** and choose **Damping**.
- 2 In the **Settings** window for **Damping**, locate the **Domain Selection** section.
- 3 From the **Selection** list, choose **Matching**.
- 4 Locate the **Damping Settings** section. From the **Input parameters** list, choose **Damping ratios**.
- 5 In the f_1 text field, type $0.99*f_0$.
- 6 In the ζ_1 text field, type 0.01 .
- 7 In the f_2 text field, type $1.01*f_0$.
- 8 In the ζ_2 text field, type 0.01 .

Elastic Waves, Time Explicit Model 1

In the **Model Builder** window, click **Elastic Waves, Time Explicit Model 1**.

Damping 2

- 1 In the **Physics** toolbar, click  **Attributes** and choose **Damping**.
- 2 In the **Settings** window for **Damping**, locate the **Domain Selection** section.
- 3 From the **Selection** list, choose **Backing**.
- 4 Locate the **Damping Settings** section. From the **Input parameters** list, choose **Damping ratios**.
- 5 In the f_1 text field, type $0.99*f_0$.
- 6 In the ζ_1 text field, type 0.025 .
- 7 In the f_2 text field, type $1.01*f_0$.
- 8 In the ζ_2 text field, type 0.025 .

Piezoelectric Material 1

In the **Model Builder** window, under **Component 1 (comp1) > Elastic Waves, Time Explicit (elte)** click **Piezoelectric Material 1**.

Mechanical Damping 1

- 1 In the **Physics** toolbar, click  **Attributes** and choose **Mechanical Damping**.
- 2 In the **Settings** window for **Mechanical Damping**, locate the **Damping Settings** section.
- 3 From the **Input parameters** list, choose **Damping ratios**.
- 4 In the f_1 text field, type $0.99*f_0$.
- 5 In the ζ_1 text field, type 0.005 .
- 6 In the f_2 text field, type $1.01*f_0$.

7 In the ζ_2 text field, type 0.005.

ADD PHYSICS

- 1 Go to the **Add Physics** window.
- 2 In the tree, select **AC/DC > Electric Fields and Currents > Electrostatics (es)**.
- 3 Click the **Add to Selection** button in the window toolbar.
- 4 In the **Physics** toolbar, click  **Add Physics** to close the **Add Physics** window.

ELECTROSTATIC (ES)

- 1 In the **Settings** window for **Electrostatics**, locate the **Domain Selection** section.
- 2 From the **Selection** list, choose **PZT**.

Charge Conservation, Piezoelectric I

- 1 In the **Physics** toolbar, click  **Domains** and choose **Charge Conservation, Piezoelectric**.
- 2 In the **Settings** window for **Charge Conservation, Piezoelectric**, locate the **Domain Selection** section.
- 3 From the **Selection** list, choose **PZT**.

Ground I

- 1 In the **Physics** toolbar, click  **Boundaries** and choose **Ground**.
- 2 Select Boundaries 29 and 57 only.

Electric Potential I

- 1 In the **Physics** toolbar, click  **Boundaries** and choose **Electric Potential**.
- 2 Select Boundary 32 only.
- 3 In the **Settings** window for **Electric Potential**, locate the **Electric Potential** section.
- 4 In the V_0 text field, type $V_{in}(t)$.

Floating Potential I

- 1 In the **Physics** toolbar, click  **Boundaries** and choose **Floating Potential**.
- 2 Select Boundary 54 only.
- 3 In the **Settings** window for **Floating Potential**, locate the **Floating Potential** section.
- 4 Select the **Floating potential group** checkbox.

Symmetry Plane I

- 1 In the **Physics** toolbar, click  **Boundaries** and choose **Symmetry Plane**.
- 2 In the **Settings** window for **Symmetry Plane**, locate the **Boundary Selection** section.

3 From the **Selection** list, choose **Symmetry**.

Add multiphysics coupling features.

MULTIPHYSICS

Piezoelectricity, Time Explicit I (pzete1)

1 In the **Physics** toolbar, click  **Multiphysics Couplings** and choose **Domain** > **Piezoelectricity, Time Explicit**.

Pair Convected Acoustic–Structure Boundary, Time Explicit I (cspte1)

1 In the **Physics** toolbar, click  **Multiphysics Couplings** and choose **Boundary** > **Pair Convected Acoustic–Structure Boundary, Time Explicit**.

2 In the **Settings** window for **Pair Convected Acoustic–Structure Boundary, Time Explicit**, locate the **Pair Selection** section.

3 Click  **Add**.

4 In the **Add** dialog, in the **Pairs** list, choose **Identity Boundary Pair 1 (ap1)** and **Identity Boundary Pair 2 (ap2)**.

5 Click **OK**.

Background Fluid Flow Coupling I (bffc1)

1 In the **Physics** toolbar, click  **Multiphysics Couplings** and choose **Domain** > **Background Fluid Flow Coupling**.

2 In the **Settings** window for **Background Fluid Flow Coupling**, locate the **Domain Selection** section.

3 From the **Selection** list, choose **Water**.

Now, set up the materials.

ADD MATERIAL

1 In the **Materials** toolbar, click  **Add Material** to open the **Add Material** window.

2 Go to the **Add Material** window.

3 In the tree, select **Built-in** > **Water, liquid**.

4 Click the **Add to Component** button in the window toolbar.

5 In the tree, select **Built-in** > **Lead Zirconate Titanate (PZT-5H)**.

6 Click the **Add to Component** button in the window toolbar.

7 In the **Materials** toolbar, click  **Add Material** to close the **Add Material** window.

MATERIALS

Lead Zirconate Titanate (PZT-5H) (mat2)

- 1 In the **Settings** window for **Material**, locate the **Geometric Entity Selection** section.
- 2 From the **Selection** list, choose **PZT**.

Matching Material

- 1 In the **Model Builder** window, right-click **Materials** and choose **Blank Material**.
- 2 In the **Settings** window for **Material**, locate the **Geometric Entity Selection** section.
- 3 From the **Selection** list, choose **Matching**.
- 4 In the **Label** text field, type Matching Material.
- 5 Locate the **Material Contents** section. In the table, enter the following settings:

Property	Variable	Value	Unit	Property group
Pressure-wave speed	cp	cp_match	m/s	Pressure-wave and shear-wave speeds
Shear-wave speed	cs	cs_match	m/s	Pressure-wave and shear-wave speeds
Density	rho	rho_match	kg/m ³	Basic

Damping Material

- 1 Right-click **Materials** and choose **Blank Material**.
- 2 In the **Settings** window for **Material**, locate the **Geometric Entity Selection** section.
- 3 From the **Selection** list, choose **Backing**.
- 4 In the **Label** text field, type Damping Material.
- 5 Locate the **Material Contents** section. In the table, enter the following settings:

Property	Variable	Value	Unit	Property group
Pressure-wave speed	cp	cp_damp	m/s	Pressure-wave and shear-wave speeds
Shear-wave speed	cs	cs_damp	m/s	Pressure-wave and shear-wave speeds
Density	rho	rho_damp	kg/m ³	Basic



Create a mesh for the CFD simulation.

MESH 1 - CFD

- 1 In the **Model Builder** window, under **Component 1 (comp1)** click **Mesh 1**.

- 2 In the **Settings** window for **Mesh**, locate the **Physics-Controlled Mesh** section.
- 3 In the table, clear the **Use** checkboxes for **Convected Wave Equation, Time Explicit (cwe)**, **Elastic Waves, Time Explicit (elte)**, **Electrostatics (es)**, **Piezoelectricity, Time Explicit I (pzetel)**, **Pair Convected Acoustic–Structure Boundary, Time Explicit I (csptel)**, and **Background Fluid Flow Coupling I (bffcl)**.
- 4 Click  **Build All**.
- 5 In the **Model Builder** window, click **Mesh I**.
- 6 In the **Label** text field, type Mesh 1 - CFD.

ADD STUDY

- 1 In the **Home** toolbar, click  **Add Study** to open the **Add Study** window.
- 2 Go to the **Add Study** window.
- 3 Find the **Physics interfaces in study** subsection. In the table, clear the **Solve** checkboxes for **Convected Wave Equation, Time Explicit (cwe)**, **Elastic Waves, Time Explicit (elte)**, and **Electrostatics (es)**.
- 4 Find the **Multiphysics couplings in study** subsection. In the table, clear the **Solve** checkboxes for **Piezoelectricity, Time Explicit I (pzetel)**, **Pair Convected Acoustic–Structure Boundary, Time Explicit I (csptel)**, and **Background Fluid Flow Coupling I (bffcl)**.
- 5 Find the **Studies** subsection. In the **Select Study** tree, select **General Studies > Stationary**.
- 6 Click the **Add Study** button in the window toolbar.
- 7 In the **Home** toolbar, click  **Add Study** to close the **Add Study** window.

STUDY I

Step 1: Stationary

- 1 In the **Model Builder** window, click **Study I**.
- 2 In the **Settings** window for **Study**, locate the **Study Settings** section.
- 3 Clear the **Generate default plots** checkbox.
- 4 In the **Label** text field, type Study 1 - CFD.
- 5 In the **Study** toolbar, click  **Compute**.

The turbulent flow interface uses linear discretization for the dependent variables. This affects the order of the geometry shape approximation which is by default the same as the discretization order chosen in the first physics interface present in the model tree. On the other hand, a higher order discretization (quartic per default) is used for the acoustics

simulation. The mismatch between the geometry and the dependent variables discretization can cause instabilities in the solution. Therefore, it is recommended that you manually increase the geometry shape approximation order to **Quadratic Lagrange**. Note that, if this change is not done a warning message is given when solving the model. In the present case, not changing the geometry shape order will also lead to numerical instabilities and incorrect results.

COMPONENT 1 (COMP1)

- 1 In the **Model Builder** window, click **Component 1 (comp1)**.
- 2 In the **Settings** window for **Component**, locate the **Curved Mesh Elements** section.
- 3 From the **Geometry shape function** list, choose **Quadratic Lagrange**.

Add absorbing layers (sponge layers) to truncate the computational domain.

DEFINITIONS

Absorbing Layer 1 (abl)

- 1 In the **Model Builder** window, expand the **Component 1 (comp1)** node.
- 2 Right-click **Component 1 (comp1) > Definitions** and choose **Absorbing Layer**.
- 3 Select Domains 1 and 3 only.

Create an acoustic mesh. The mesh should be fine enough to resolve the shortest wavelength in each material. Note that the mesh element nodes on one side of the boundary pairs do not match with those on the other side. As a result, the mesh elements adjacent to the pairs have different size, which helps to reduce the number of DOFs in the model.

MESH 2 - ACOUSTICS

- 1 In the **Mesh** toolbar, click **Add Mesh** and choose **Add Mesh**.
- 2 In the **Settings** window for **Mesh**, type Mesh 2 - Acoustics in the **Label** text field.

Free Triangular 1

- 1 In the **Mesh** toolbar, click  **More Generators** and choose **Free Triangular**.
- 2 Select Boundaries 32, 35, 37, 42, 43, and 54 only.

Size 1

- 1 Right-click **Free Triangular 1** and choose **Size**.
- 2 Select Boundaries 32 and 54 only.
- 3 In the **Settings** window for **Size**, locate the **Element Size** section.

- 4 Click the **Custom** button.
- 5 Locate the **Element Size Parameters** section.
- 6 Select the **Maximum element size** checkbox. In the associated text field, type $cs_pzt / f0/2$.

Size 2

- 1 In the **Model Builder** window, right-click **Free Triangular 1** and choose **Size**.
- 2 Select Boundaries 35, 37, 42, and 43 only.
- 3 In the **Settings** window for **Size**, locate the **Element Size** section.
- 4 Click the **Custom** button.
- 5 Locate the **Element Size Parameters** section.
- 6 Select the **Maximum element size** checkbox. In the associated text field, type $cs_match / f0/2$.

Swept 1

- 1 In the **Mesh** toolbar, click  **Swept**.
- 2 In the **Settings** window for **Swept**, locate the **Domain Selection** section.
- 3 From the **Geometric entity level** list, choose **Domain**.
- 4 From the **Selection** list, choose **PZT**.

Distribution 1

- 1 Right-click **Swept 1** and choose **Distribution**.
- 2 In the **Settings** window for **Distribution**, locate the **Distribution** section.
- 3 In the **Number of elements** text field, type 4.

Swept 2

- 1 In the **Mesh** toolbar, click  **Swept**.
- 2 In the **Settings** window for **Swept**, locate the **Domain Selection** section.
- 3 From the **Geometric entity level** list, choose **Domain**.
- 4 From the **Selection** list, choose **Matching**.

Distribution 1

- 1 Right-click **Swept 2** and choose **Distribution**.
- 2 In the **Settings** window for **Distribution**, locate the **Distribution** section.
- 3 In the **Number of elements** text field, type 2.

Free Tetrahedral 1

- 1 In the **Mesh** toolbar, click  **Free Tetrahedral**.

When modeling using physics interfaces that are based on the DG method, it is important to avoid small mesh elements, since they control the time steps taken by the solver. Use the **Element Quality Optimization** functionality available for the tetrahedral mesh to avoid this. This step is very important.

- 2 In the **Settings** window for **Free Tetrahedral**, click to expand the **Element Quality Optimization** section.
- 3 From the **Optimization level** list, choose **High**.
- 4 Select the **Avoid elements that are too small** checkbox.

Size 1

- 1 Right-click **Free Tetrahedral 1** and choose **Size**.
- 2 In the **Settings** window for **Size**, locate the **Geometric Entity Selection** section.
- 3 From the **Geometric entity level** list, choose **Domain**.
- 4 From the **Selection** list, choose **Water**.
- 5 Locate the **Element Size** section. Click the **Custom** button.
- 6 Locate the **Element Size Parameters** section.
- 7 Select the **Maximum element size** checkbox. In the associated text field, type $1\text{m}0/1.5$.
- 8 Select the **Minimum element size** checkbox. In the associated text field, type $1\text{m}0/3$.



Size 2

- 1 In the **Model Builder** window, right-click **Free Tetrahedral 1** and choose **Size**.
- 2 In the **Settings** window for **Size**, locate the **Geometric Entity Selection** section.
- 3 From the **Geometric entity level** list, choose **Domain**.
- 4 From the **Selection** list, choose **Backing**.
- 5 Locate the **Element Size** section. Click the **Custom** button.
- 6 Locate the **Element Size Parameters** section.
- 7 Select the **Maximum element size** checkbox. In the associated text field, type $\text{cs_damp}/\text{f}0/1.5$.

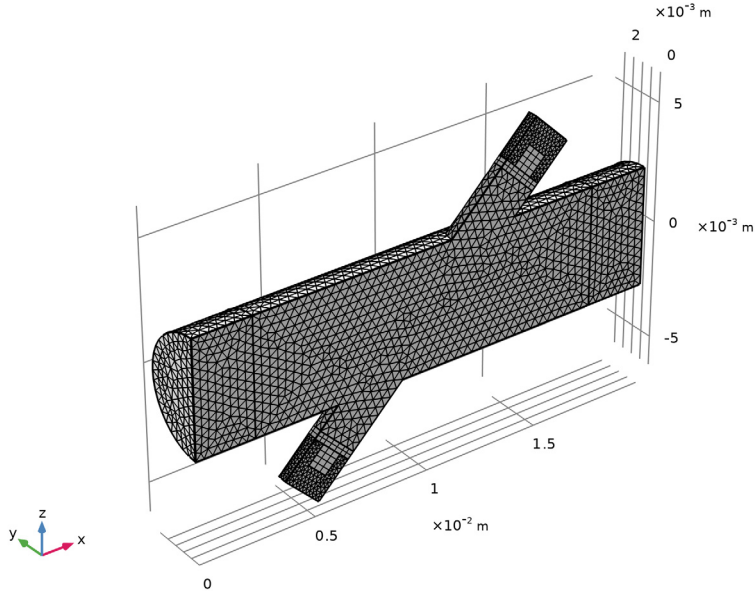
8 In the **Model Builder** window, right-click **Mesh 2 - Acoustics** and choose **Build All**.



ADD STUDY

- 1 In the **Home** toolbar, click  **Add Study** to open the **Add Study** window.
- 2 Go to the **Add Study** window.
- 3 Find the **Physics interfaces in study** subsection. In the table, clear the **Solve** checkboxes for **Turbulent Flow, k- ω (spf)**, **Convected Wave Equation, Time Explicit (cwe)**, **Elastic Waves, Time Explicit (elte)**, and **Electrostatics (es)**.
- 4 Find the **Multiphysics couplings in study** subsection. In the table, clear the **Solve** checkboxes for **Piezoelectricity, Time Explicit I (pzetel)** and **Pair Convected Acoustic-Structure Boundary, Time Explicit I (cspteI)**.
- 5 Find the **Studies** subsection. In the **Select Study** tree, select **Preset Studies for Selected Multiphysics > Mapping**.
- 6 Click the **Add Study** button in the window toolbar.
- 7 In the **Home** toolbar, click  **Add Study** to close the **Add Study** window.



STUDY 2 - MAPPING

- 1 In the **Settings** window for **Study**, type Study 2 - Mapping in the **Label** text field.
- 2 Locate the **Study Settings** section. Clear the **Generate default plots** checkbox.

Step 1: Mapping

- 1 In the **Model Builder** window, under **Study 2 - Mapping** click **Step 1: Mapping**.
- 2 In the **Settings** window for **Mapping**, locate the **Data to Map** section.
- 3 From the **Source** list, choose **Study 1 - CFD, Stationary**.
- 4 Click to expand the **Destination Mesh Selection** section. In the **Study** toolbar, click  **Compute**.

ADD STUDY

- 1 In the **Home** toolbar, click  **Add Study** to open the **Add Study** window.
- 2 Go to the **Add Study** window.
- 3 Find the **Physics interfaces in study** subsection. In the table, clear the **Solve** checkbox for **Turbulent Flow, k- ω (spf)**.
- 4 Find the **Multiphysics couplings in study** subsection. In the table, clear the **Solve** checkbox for **Background Fluid Flow Coupling 1 (bffc1)**.
- 5 Find the **Studies** subsection. In the **Select Study** tree, select **General Studies > Time Dependent**.
- 6 Click the **Add Study** button in the window toolbar.
- 7 In the **Home** toolbar, click  **Add Study** to close the **Add Study** window.

STUDY 3 - ACOUSTICS

- 1 In the **Settings** window for **Study**, locate the **Study Settings** section.
- 2 Clear the **Generate default plots** checkbox.
- 3 In the **Label** text field, type **Study 3 - Acoustics**.

Step 1: Time Dependent

- 1 In the **Model Builder** window, under **Study 3 - Acoustics** click **Step 1: Time Dependent**.
- 2 In the **Settings** window for **Time Dependent**, locate the **Study Settings** section.
- 3 In the **Output times** text field, type range (0, T0/5, 30*T0).
- 4 Click to expand the **Values of Dependent Variables** section. Find the **Values of variables not solved for** subsection. From the **Settings** list, choose **User controlled**.
- 5 From the **Method** list, choose **Solution**.
- 6 From the **Study** list, choose **Study 2 - Mapping, Mapping**.

7 Click to expand the **Store in Output** section. In the table, enter the following settings:

Interface	Output
Turbulent Flow, k- ω (spf)	Selection

8 Click to select row number 1 in the table.

9 Under **Selections**, click **+ Add** to store the results on the symmetry plane only.

10 In the **Add** dialog, select **Symmetry** in the **Selections** list.

11 Click **OK**.

12 In the **Settings** window for **Time Dependent**, locate the **Store in Output** section.

13 In the table, enter the following settings:

Interface	Output
Convected Wave Equation, Time Explicit (cwe)	Selection

14 Click to select row number 2 in the table.

15 Under **Selections**, click **+ Add**.

16 In the **Add** dialog, select **Symmetry** in the **Selections** list.

17 Click **OK**.

18 In the **Settings** window for **Time Dependent**, locate the **Store in Output** section.

19 In the table, enter the following settings:

Interface	Output
Elastic Waves, Time Explicit (elte)	Selection

20 Click to select row number 3 in the table.

21 Under **Selections**, click **+ Add**.

22 In the **Add** dialog, select **Symmetry** in the **Selections** list.

23 Click **OK**.

24 In the **Settings** window for **Time Dependent**, locate the **Store in Output** section.

25 In the table, enter the following settings:

Interface	Output
Electrostatics (es)	Selection

26 Click to select row number 4 in the table.

27 Under **Selections**, click **+ Add**.

28 In the **Add** dialog, select **Symmetry** in the **Selections** list.

29 Click **OK**.

30 In the **Study** toolbar, click  **Compute**.

In the following postprocessing the **Resolution** is increased under the **Quality** section in all acoustics plots. This is due to the discretization used for the acoustics interfaces, which is 4th order per default. So in order to properly represent the solution, the resolution needs to be increased.

RESULTS

Background Flow Velocity

1 In the **Home** toolbar, click  **Add Plot Group** and choose **3D Plot Group**.

2 In the **Settings** window for **3D Plot Group**, type Background Flow Velocity in the **Label** text field.

3 Locate the **Color Legend** section. Select the **Show maximum and minimum values** checkbox.

4 Select the **Show units** checkbox.

Surface 1

1 Right-click **Background Flow Velocity** and choose **Surface**.

2 In the **Background Flow Velocity** toolbar, click  **Plot**.

The background mean flow velocity amplitude plotted on the surface of the geometry should look like [Figure 2](#).

Acoustic and Elastic Pressure

In the **Results** toolbar, click  **3D Plot Group**.

Plot the pressure in the fluid and solid domains and inspect the propagating acoustic signal at different times to get the results like the ones in [Figure 3](#).

1 In the **Settings** window for **3D Plot Group**, type Acoustic and Elastic Pressure in the **Label** text field.

2 Click to expand the **Title** section. From the **Title type** list, choose **Label**.

3 Locate the **Data** section. From the **Dataset** list, choose **Study 3 - Acoustics/Solution 3 (sol3)**.

4 Locate the **Color Legend** section. Select the **Show maximum and minimum values** checkbox.

5 Select the **Show units** checkbox.

Surface 1

Right-click **Acoustic and Elastic Pressure** and choose **Surface**.

Surface 1

- 1 In the **Model Builder** window, expand the **Results > Acoustic and Elastic Pressure** node, then click **Surface 1**.
- 2 In the **Settings** window for **Surface**, locate the **Expression** section.
- 3 In the **Expression** text field, type p_2 .
- 4 Locate the **Coloring and Style** section. From the **Color table** list, choose **Wave**.
- 5 From the **Scale** list, choose **Linear symmetric**.
- 6 Click to expand the **Quality** section. From the **Evaluation settings** list, choose **Manual**.
- 7 From the **Resolution** list, choose **Custom**.
- 8 In the **Element refinement** text field, type 6.
- 9 From the **Smoothing** list, choose **Inside geometry domains**.

Selection 1

- 1 Right-click **Surface 1** and choose **Selection**.
- 2 In the **Settings** window for **Selection**, locate the **Selection** section.
- 3 From the **Selection** list, choose **Symmetry**.

Surface 2

- 1 Right-click **Surface 1** and choose **Duplicate**.
- 2 In the **Settings** window for **Surface**, click **Replace Expression** in the upper-right corner of the **Expression** section. From the menu, choose **Component 1 (comp1) > Elastic Waves, Time Explicit > Stress > elte.p - Pressure - Pa**.
- 3 Click to expand the **Inherit Style** section. From the **Plot** list, choose **Surface 1**.

Acoustic and Elastic Pressure

Right-click **Surface 2** and choose **Surface**.

Surface 3

- 1 In the **Settings** window for **Surface**, locate the **Expression** section.
- 2 In the **Expression** text field, type 1.

Selection 1

- 1 Right-click **Surface 3** and choose **Selection**.
- 2 Select Boundaries 3, 4, 7–9, 11–13, 17, and 18 only.

Material Appearance 1

- 1 Right-click **Surface 3** and choose **Material Appearance**.
- 2 In the **Settings** window for **Material Appearance**, locate the **Appearance** section.
- 3 From the **Appearance** list, choose **Custom**.
- 4 From the **Material type** list, choose **Steel**.

Acoustic and Elastic Pressure

Right-click **Material Appearance 1** and choose **Surface**.

Surface 4

- 1 In the **Settings** window for **Surface**, locate the **Expression** section.
- 2 In the **Expression** text field, type 1.

Selection 1

Right-click **Surface 4** and choose **Selection**.

Selection 1

- 1 In the **Model Builder** window, expand the **Results > Acoustic and Elastic Pressure > Surface 4** node, then click **Selection 1**.
- 2 Select Boundaries 20, 23, 34, 38, 39, 44, 47, and 50 only.

Material Appearance 1

- 1 In the **Model Builder** window, right-click **Surface 4** and choose **Material Appearance**.
- 2 In the **Settings** window for **Material Appearance**, locate the **Appearance** section.
- 3 From the **Appearance** list, choose **Custom**.
- 4 From the **Color** list, choose **Custom**.
- 5 On Windows, click the colored bar underneath, or — if you are running the cross-platform desktop — the **Color** button.
- 6 Click **Define custom colors**.
- 7 Set the RGB values to 255, 160, and 122, respectively.
- 8 Click **Add to custom colors**.
- 9 Click **Show color palette only** or **OK** on the cross-platform desktop.

Plot the driving voltage applied to the transmitter and the voltage signal read on the receiver. The result should look like the one in [Figure 4](#).

Sent and Received Signals

- 1 In the **Results** toolbar, click  **ID Plot Group**.

- 2 In the **Settings** window for **ID Plot Group**, type Sent and Received Signals in the **Label** text field.
- 3 Locate the **Data** section. From the **Dataset** list, choose **Study 3 - Acoustics/ Solution 3 (sol3)**.
- 4 From the **Time selection** list, choose **Interpolated**.
- 5 In the **Times (s)** text field, type range (0, T0/20, 30*T0).
- 6 Click to expand the **Title** section. From the **Title type** list, choose **Label**.

Point Graph 1

- 1 Right-click **Sent and Received Signals** and choose **Point Graph**.
- 2 Select Point 39 only.
- 3 In the **Settings** window for **Point Graph**, locate the **y-Axis Data** section.
- 4 In the **Expression** text field, type $V/V0$.
- 5 Click to expand the **Quality** section. Click to expand the **Legends** section. Select the **Show legends** checkbox.
- 6 From the **Legends** list, choose **Manual**.
- 7 In the table, enter the following settings:

Legends

Relative driving voltage

Point Graph 2

- 1 Right-click **Point Graph 1** and choose **Duplicate**.
- 2 In the **Settings** window for **Point Graph**, locate the **Selection** section.
- 3 Click  **Clear Selection**.
- 4 Select Point 73 only.
- 5 Locate the **Legends** section. In the table, enter the following settings:

Legends

Relative received voltage

Sent and Received Signals

- 1 In the **Model Builder** window, click **Sent and Received Signals**.
- 2 In the **Settings** window for **ID Plot Group**, locate the **Plot Settings** section.
- 3 Select the **Two y-axes** checkbox.
- 4 In the table, select the **Plot on secondary y-axis** checkbox for **Point Graph 2**.

- 5 Locate the **Axis** section. Select the **Manual axis limits** checkbox.
- 6 In the **x minimum** text field, type 0.
- 7 In the **x maximum** text field, type $30 \cdot T_0$.
- 8 In the **y minimum** text field, type -1.
- 9 In the **y maximum** text field, type 1.
- 10 In the **Secondary y minimum** text field, type -0.015.
- 11 In the **Secondary y maximum** text field, type 0.015.
- 12 Locate the **Legend** section. From the **Position** list, choose **Upper middle**.
- 13 In the **Sent and Received Signals** toolbar, click  **Plot**.



Appendix — Geometry Modeling Instructions

From the **File** menu, choose **New**.

NEW

In the **New** window, click  **Model Wizard**.

MODEL WIZARD



- 1 In the **Model Wizard** window, click  **3D**.
- 2 Click  **Done**.

GLOBAL DEFINITIONS

Geometry Parameters

- 1 In the **Model Builder** window, under **Global Definitions** click **Parameters I**.
- 2 In the **Settings** window for **Parameters**, locate the **Parameters** section.
- 3 Click  **Load from File**.
- 4 Browse to the model's Application Libraries folder and double-click the file `flow_meter_piezoelectric_transducers_geometry_parameters.txt`.
- 5 In the **Label** text field, type `Geometry Parameters`.

Model Parameters

- 1 In the **Home** toolbar, click  **Parameters** and choose **Add > Parameters**.
- 2 In the **Settings** window for **Parameters**, locate the **Parameters** section.
- 3 Click  **Load from File**.

- 4 Browse to the model's Application Libraries folder and double-click the file `flow_meter_piezoelectric_transducers_model_parameters.txt`.
- 5 In the **Label** text field, type `Model Parameters`.

GEOMETRY 1

Cylinder 1 (cyl1)

- 1 In the **Geometry** toolbar, click  **Cylinder**.
- 2 In the **Settings** window for **Cylinder**, locate the **Axis** section.
- 3 From the **Axis type** list, choose **x-axis**.
- 4 Locate the **Size and Shape** section. In the **Radius** text field, type $D/2$.
- 5 In the **Height** text field, type L .
- 6 Click to expand the **Layers** section. In the table, enter the following settings:

Layer name	Thickness (m)
Layer 1	$0.5*D$

- 7 Clear the **Layers on side** checkbox.
- 8 Select the **Layers on bottom** checkbox.
- 9 Select the **Layers on top** checkbox.

Cylinder 2 (cyl2)

- 1 In the **Geometry** toolbar, click  **Cylinder**.
- 2 In the **Settings** window for **Cylinder**, locate the **Size and Shape** section.
- 3 In the **Radius** text field, type $D_transducer/2$.
- 4 In the **Height** text field, type $L_transducer$.
- 5 Locate the **Position** section. In the **x** text field, type $L/2$.
- 6 In the **z** text field, type $-L_transducer/2$.

Cylinder 3 (cyl3)

- 1 In the **Geometry** toolbar, click  **Cylinder**.
- 2 In the **Settings** window for **Cylinder**, locate the **Size and Shape** section.
- 3 In the **Radius** text field, type $D_transducer/2$.
- 4 In the **Height** text field, type $L_matching$.
- 5 Locate the **Position** section. In the **x** text field, type $L/2$.
- 6 In the **z** text field, type $L_transducer/2$.



Cylinder 4 (cyl4)

- 1 In the **Geometry** toolbar, click  **Cylinder**.
- 2 In the **Settings** window for **Cylinder**, locate the **Size and Shape** section.
- 3 In the **Radius** text field, type $D_transducer/4$.
- 4 In the **Height** text field, type L_piezo .
- 5 Locate the **Position** section. In the **x** text field, type $L/2$.
- 6 In the **z** text field, type $L_transducer/2+L_matching$.

Cylinder 5 (cyl5)

- 1 In the **Geometry** toolbar, click  **Cylinder**.
- 2 In the **Settings** window for **Cylinder**, locate the **Size and Shape** section.
- 3 In the **Radius** text field, type $D_transducer/2$.
- 4 In the **Height** text field, type $2*L_piezo$.
- 5 Locate the **Position** section. In the **x** text field, type $L/2$.
- 6 In the **z** text field, type $L_transducer/2+L_matching$.

Difference 1 (dif1)

- 1 In the **Geometry** toolbar, click  **Booleans and Partitions** and choose **Difference**.
- 2 Select the object **cyl5** only.
- 3 In the **Settings** window for **Difference**, locate the **Difference** section.
- 4 Click to select the  **Activate Selection** toggle button for **Objects to subtract**.
- 5 Select the object **cyl4** only.
- 6 Select the **Keep objects to subtract** checkbox.

Copy 1 (copy1)

- 1 In the **Geometry** toolbar, click  **Transforms** and choose **Copy**.
- 2 Select the objects **cyl3**, **cyl4**, and **dif1** only.
- 3 In the **Settings** window for **Copy**, locate the **Displacement** section.
- 4 In the **z** text field, type $-L_transducer$.

Mirror 1 (mir1)

- 1 In the **Geometry** toolbar, click  **Transforms** and choose **Mirror**.
- 2 Select the objects **copy1(1)**, **copy1(2)**, and **copy1(3)** only.
- 3 In the **Settings** window for **Mirror**, locate the **Point on Plane of Reflection** section.
- 4 In the **z** text field, type $-L_transducer/2$.



Rotate 1 (rot1)

- 1 In the **Geometry** toolbar, click  **Transforms** and choose **Rotate**.
- 2 Select the objects **cyl2**, **cyl3**, **cyl4**, **dif1**, **mir1(1)**, **mir1(2)**, and **mir1(3)** only.
- 3 In the **Settings** window for **Rotate**, locate the **Rotation** section.
- 4 From the **Axis type** list, choose **y-axis**.
- 5 In the **Angle** text field, type α .
- 6 Locate the **Point on Axis of Rotation** section. In the **x** text field, type $L/2$.

Work Plane 1 (wpl)

- 1 In the **Geometry** toolbar, click  **Work Plane**.
- 2 In the **Settings** window for **Work Plane**, locate the **Plane Definition** section.
- 3 From the **Plane** list, choose **xz-plane**.

Partition Objects 1 (par1)

- 1 In the **Geometry** toolbar, click  **Booleans and Partitions** and choose **Partition Objects**.
- 2 Click the  **Select Box** button in the **Graphics** toolbar.
- 3 Click in the **Graphics** window and then press Ctrl+A to select all objects.
- 4 In the **Settings** window for **Partition Objects**, locate the **Partition Objects** section.
- 5 From the **Partition with** list, choose **Work plane**.

Delete Entities 1 (dell)

- 1 In the **Model Builder** window, right-click **Geometry 1** and choose **Delete Entities**.
- 2 In the **Settings** window for **Delete Entities**, locate the **Entities or Objects to Delete** section.
- 3 From the **Geometric entity level** list, choose **Domain**.
- 4 On the object **par1(1)**, select Domains 1, 3, and 5 only.
- 5 On the object **par1(2)**, select Domain 1 only.
- 6 On the object **par1(3)**, select Domain 1 only.
- 7 On the object **par1(4)**, select Domain 1 only.
- 8 On the object **par1(5)**, select Domain 1 only.
- 9 On the object **par1(6)**, select Domain 1 only.
- 10 On the object **par1(7)**, select Domain 1 only.
- 11 On the object **par1(8)**, select Domain 1 only.

Union 1 (uni1)

- 1 In the **Geometry** toolbar, click  **Booleans and Partitions** and choose **Union**.
- 2 Select the objects **dell(1)** and **dell(2)** only.

Delete Entities 2 (del2)



- 1 Right-click **Geometry I** and choose **Delete Entities**.
- 2 On the object **uni1**, select Boundaries 13, 14, 16, and 19 only.

Form Union (fin)

- 1 In the **Model Builder** window, under **Component 1 (comp1) > Geometry I** click **Form Union (fin)**.
- 2 In the **Settings** window for **Form Union/Assembly**, locate the **Form Union/Assembly** section.
- 3 From the **Action** list, choose **Form an assembly**.
Make sure to select the **Create imprints** checkbox to create an assembly with still matching surface pairs. This will eliminate the use of fallback and thus increase the performance.
- 4 Select the **Create imprints** checkbox.

- 5 Click  **Build Selected**.

Ignore Edges 1 (ige1)

- 1 In the **Geometry** toolbar, click  **Virtual Operations** and choose **Ignore Edges**.
- 2 On the object **fin**, select Edges 19, 20, 23, and 27 only.
- 3 In the **Settings** window for **Ignore Edges**, click  **Build Selected**.