



Model created in COMSOL Multiphysics 6.4

Quadrupole Lens

Introduction

Just like optical lenses focus light, electric and magnetic lenses can focus beams of charged particles. Systems of magnetic quadrupole lenses find a common use in focusing both ion and particle beams in accelerators at nuclear and particle physics centers such as CERN, SLAC, and ISIS. This COMSOL Multiphysics model shows the path of B^{5+} ions going through three consecutive magnetic quadrupole lenses. This 3D model takes fringing fields into account, and the calculation of the forces on the ions uses all components of their velocities.

Model Definition

The quadrupole consists of an assembly of four permanent magnets, as seen in [Figure 1](#), where the magnets work together to give a good approximation of a quadrupole field. To strengthen the field and keep it contained within the system, the magnets are set in an iron cylinder.

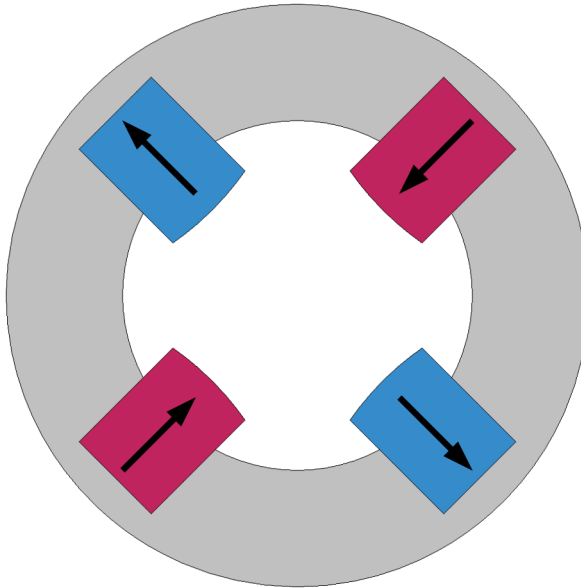

Figure 1: Cross-sectional view of one of the magnetic quadrupoles used in the lens. The arrows show the direction of the magnetization.

The ions are sent through a system of three consecutive quadrupole assemblies. The middle one is twice as long as the other ones, and is rotated by 90 degrees around the central axis. This means the polarity of its magnets is reversed. [Figure 2](#) gives a full view of the magnetic quadrupole lens.

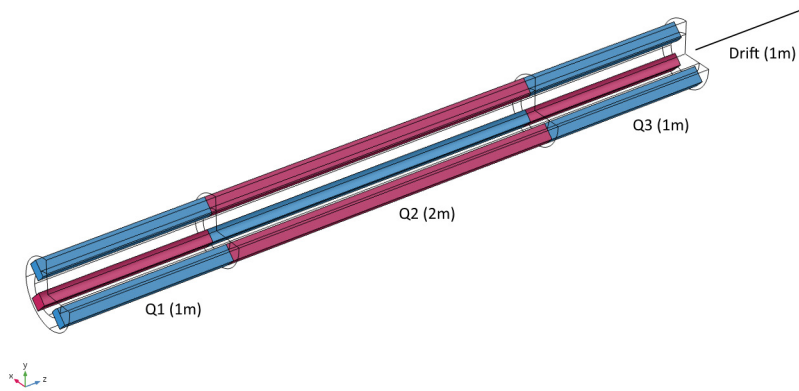

Figure 2: Cutout of the quadrupole lens. The second quadrupole (Q2) has its polarities reversed compared to Q1 and Q3. After traveling through the lens, the ions are left to drift 1 m.

An accelerator feeds the system with ions traveling with the velocity $0.01c$ along the central axis. To study the focusing effect of the quadrupoles, track a number of ions starting out from a distance of 3 cm from the central axis, evenly distributed along the circumference of a circle in the transverse plane. They are all assumed to have a zero initial transverse velocity. Each quadrupole focuses the ion beam along one of the transverse axes and defocuses it along the other one. The net effect after traveling through the system of the three quadrupoles and the drift length is focusing in all directions. As the ions exit the system, they are all contained within a 1 cm radius in the transverse plane.

The geometry of the quadrupole lens is composed of three quadrupoles in a row, followed by 1 m of empty space, where the ions are left to drift. The AC/DC Module features a physics interface for magnetostatics in absence of currents. The formulation used in this physics interface reduces the memory usage considerably compared to the formulation including currents.

DOMAIN EQUATIONS

The magnetic field is described using a static magnetic equation solving for the magnetic scalar potential V_m (Wb/m):

$$-\nabla \cdot (\mu_0 \mu_{\text{rec}} \nabla V_m - \mathbf{B}_r) = 0$$

where $\mu_0 = 4\pi \cdot 10^{-7}$ H/m denotes the permeability of vacuum and \mathbf{B}_r is the remanent flux density (T). In the iron domain

$$-\nabla \cdot (\mu_0 \mu_r \nabla V_m) = 0$$

where $\mu_r = 4000$ is the relative permeability. The magnetic scalar potential is everywhere defined so that $\mathbf{H} = \nabla V_m$.

BOUNDARY CONDITIONS

The *magnetic insulation* boundary condition, reading $\mathbf{n} \cdot \mathbf{B} = 0$, is used all around the iron cylinder, and at the lateral surfaces of the air domain that encloses the drift length.

Results

The x -component of the magnetic field density and arrows showing its local direction are shown in the figure below.

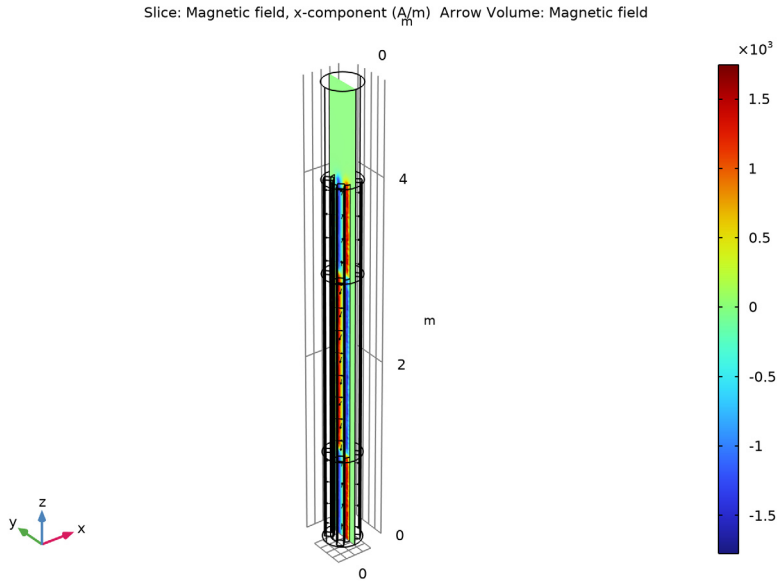

Figure 3: Arrows of the magnetic field and slices of its x -component in the quadrupole lens.

Each ion passing through the assembly experiences Maxwell forces equal to $\mathbf{F} = q\mathbf{v} \times \mathbf{B}$, where \mathbf{v} (SI unit: m/s) is the velocity of the ion. To find the transverse position as a function of time, solve Newton's second law for each ion: $q\mathbf{v} \times \mathbf{B} = m\mathbf{a}$. This particle tracing operation can be performed in postprocessing (in a Plot Group) and does not

require the Particle Tracing Module. Figure 4 shows the traces of the ions as they fly through the quadrupole lens.

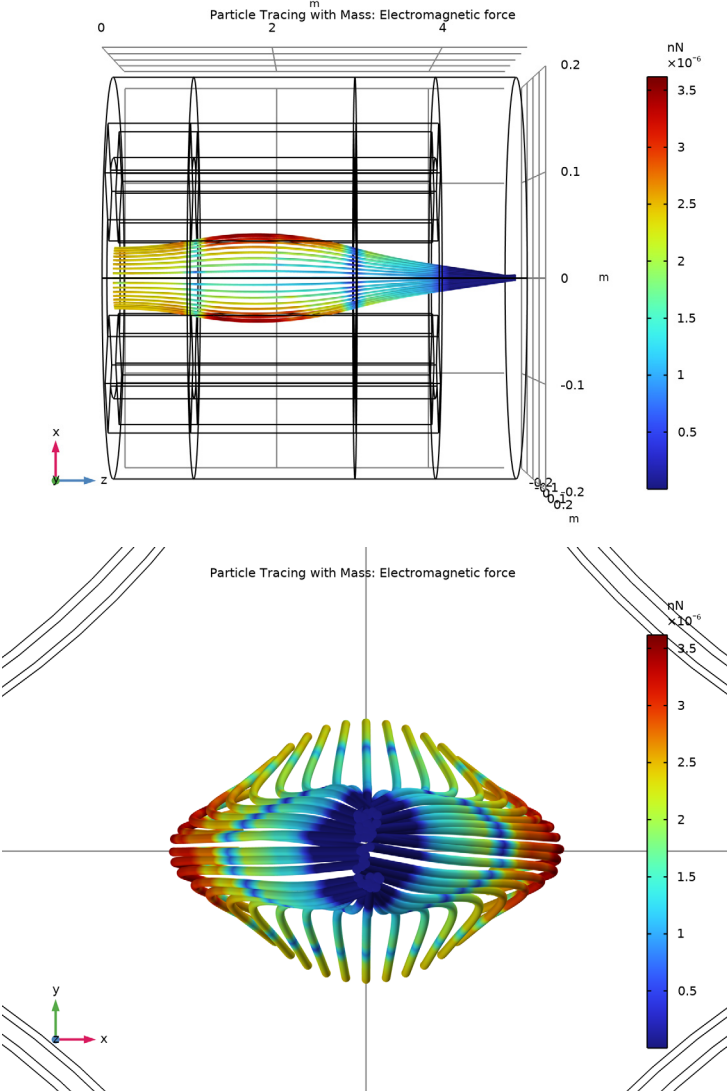



Figure 4: Particle tracing plots of the ions. Two cross-sections of the geometry are shown. The line colors show the local force acting on each ion. The force grows larger (red) far away from the center of the beam line and smaller (blue) where two oppositely polarized quadrupoles join. The z-axis is rescaled in the top figure.

Application Library path: ACDC_Module/
Electromagnetics_and_Particle_Tracing/quadrupole_lens



Modeling Instructions

From the **File** menu, choose **New**.

NEW

In the **New** window, click  **Model Wizard**.

MODEL WIZARD

- 1 In the **Model Wizard** window, click  **3D**.
- 2 In the **Select Physics** tree, select **AC/DC > Magnetic Fields, No Currents > Magnetic Fields, No Currents (mfnc)**.
- 3 Click **Add**.
- 4 Click  **Study**.
- 5 In the **Select Study** tree, select **General Studies > Stationary**.
- 6 Click  **Done**.

GEOMETRY I

Import 1 (impl)

- 1 In the **Geometry** toolbar, click  **Import**.
- 2 In the **Settings** window for **Import**, locate the **Source** section.
- 3 Click  **Browse**.
- 4 Browse to the model's Application Libraries folder and double-click the file `quadrupole_lens.mphbin`.
- 5 Click  **Import**.

GLOBAL DEFINITIONS

Parameters 1

- 1 In the **Model Builder** window, under **Global Definitions** click **Parameters 1**.
- 2 In the **Settings** window for **Parameters**, locate the **Parameters** section.
- 3 Click  **Load from File**.

- 4 Browse to the model's Application Libraries folder and double-click the file `quadrupole_lens_parameters.txt`.
- 5 Click the  **Wireframe Rendering** button in the **Graphics** toolbar.

MAGNETIC FIELDS, NO CURRENTS (MFNC)

Magnetic Flux Conservation in Solids I

- 1 In the **Physics** toolbar, click  **Domains** and choose **Magnetic Flux Conservation in Solids**.
- 2 Select Domains 1–3, 5–10, and 14–19 only.



MATERIALS

Iron

- 1 In the **Model Builder** window, under **Component 1 (comp1)** right-click **Materials** and choose **Blank Material**.
- 2 In the **Settings** window for **Material**, type Iron in the **Label** text field.
- 3 Select Domains 1–3 only.
- 4 Locate the **Material Contents** section. In the table, enter the following settings:

Property	Variable	Value	Unit	Property group
Relative permeability	mur_iso ; murii = mur_iso, murij = 0	4000		Basic

Magnets

- 1 In the **Materials** toolbar, click  **Blank Material**.
- 2 In the **Settings** window for **Material**, type Magnets in the **Label** text field.
- 3 Locate the **Geometric Entity Selection** section. Click  **Paste Selection**.
- 4 In the **Paste Selection** dialog, type 5-10, 14-19 in the **Selection** text field.
- 5 Click **OK**.
- 6 In the **Settings** window for **Material**, click to expand the **Material Properties** section.
- 7 In the **Material properties** tree, select **Electromagnetic Models > Remanent Flux Density > Recoil permeability (murec)**.
- 8 Click  **Add to Material**.

9 In the **Material properties** tree, select **Electromagnetic Models > Remanent Flux Density > Remanent flux density norm (normBr)**.

10 Locate the **Material Contents** section. In the table, enter the following settings:

Property	Variable	Value	Unit	Property group
Recoil permeability	murec_iso ; murecii = murec_iso, murecij = 0	1.05	I	Remanent flux density
Remanent flux density norm	normBr	Br	T	Remanent flux density

MAGNETIC FIELDS, NO CURRENTS (MFNC)

Magnet 1

- 1 In the **Physics** toolbar, click  **Domains** and choose **Magnet**.
- 2 Select Domains 5–10 and 14–19 only.
- 3 In the **Settings** window for **Magnet**, locate the **Magnet** section.
- 4 From the **Pattern type** list, choose **Circular pattern**.
- 5 From the **Type of periodicity** list, choose **Alternating**.

North 1

- 1 In the **Model Builder** window, click **North 1**.
- 2 Select Boundaries 18, 56, and 58 only.

South 1

- 1 In the **Model Builder** window, click **South 1**.
- 2 Select Boundaries 15, 21, and 57 only.

Add a zero potential point condition to fix the magnetic scalar potential. Without it, the solution would be determined only up to a constant.

Zero Magnetic Scalar Potential 1

- 1 In the **Physics** toolbar, click  **Points** and choose **Zero Magnetic Scalar Potential**.
- 2 Select Point 1 only.

MESH 1

- 1 In the **Model Builder** window, under **Component 1 (comp1)** click **Mesh 1**.
- 2 In the **Settings** window for **Mesh**, locate the **Physics-Controlled Mesh** section.

3 From the **Element size** list, choose **Fine**.

4 Click  **Build All**.

STUDY I

1 In the **Model Builder** window, click **Study I**.

2 In the **Settings** window for **Study**, locate the **Study Settings** section.

3 Clear the **Generate default plots** checkbox.

4 In the **Study** toolbar, click  **Compute**.

RESULTS

Magnetic Field

1 In the **Results** toolbar, click  **3D Plot Group**.

2 In the **Settings** window for **3D Plot Group**, type **Magnetic Field** in the **Label** text field.

Slice I

1 Right-click **Magnetic Field** and choose **Slice**.

2 In the **Settings** window for **Slice**, locate the **Plane Data** section.

3 In the **Planes** text field, type 1.

4 Click **Replace Expression** in the upper-right corner of the **Expression** section. From the menu, choose **Component I (comp1) > Magnetic Fields, No Currents > Magnetic > Magnetic field - A/m > mfnc.Hx - Magnetic field, x-component**.

5 In the **Magnetic Field** toolbar, click  **Plot**.

The plot now shows the x -component of the magnetic field.

Arrow Volume I

1 In the **Model Builder** window, right-click **Magnetic Field** and choose **Arrow Volume**.

2 In the **Settings** window for **Arrow Volume**, click **Replace Expression** in the upper-right corner of the **Expression** section. From the menu, choose **Component I (comp1) > Magnetic Fields, No Currents > Magnetic > mfnc.Hx,mfnc.Hy,mfnc.Hz - Magnetic field**.

3 Locate the **Arrow Positioning** section. Find the **x grid points** subsection. In the **Points** text field, type 4.

4 Find the **y grid points** subsection. In the **Points** text field, type 4.



5 Find the **z grid points** subsection. In the **Points** text field, type 20.

6 Locate the **Coloring and Style** section. From the **Color** list, choose **Black**.

7 In the **Magnetic Field** toolbar, click  **Plot**.

Add a new plot group to trace the ions as they travel through the system of quadrupoles.

Ion Tracing

- 1 In the **Results** toolbar, click  **3D Plot Group**.
- 2 Click the  **Show More Options** button in the **Model Builder** toolbar.
- 3 In the **Show More Options** dialog, in the tree, select the checkbox for the node **Results > All Plot Types**.
- 4 Click **OK**.
- 5 In the **Settings** window for **3D Plot Group**, type **Ion Tracing** in the **Label** text field.
- 6 Locate the **Color Legend** section. Select the **Show units** checkbox.

Particle Tracing with Mass

- 1 In the **Ion Tracing** toolbar, click  **More Plots** and choose **Particle Tracing with Mass**.
The default expression for the force is the magnetic force acting on the ions. Enter the values of the parameters.
- 2 In the **Settings** window for **Particle Tracing with Mass**, locate the **Total Force** section.
- 3 Find the **Parameters** subsection. In the table, enter the following settings:

Name	Value	Unit	Description
partq	q	C	Electric charge

- 4 Click to expand the **Mass and Velocity** section. In the **Mass** text field, type **m**.
- 5 Find the **Initial velocity** subsection. In the **z-component** text field, type **vz**.
- 6 Locate the **Particle Positioning** section. In the **x** text field, type $0.03 \cdot \cos(\text{range}(0, 0.05 \cdot \pi, 2 \cdot \pi))$.
- 7 In the **y** text field, type $0.03 \cdot \sin(\text{range}(0, 0.05 \cdot \pi, 2 \cdot \pi))$.
- 8 In the **z** text field, type **0.01**.
- 9 Click to expand the **Coloring and Style** section. Find the **Line style** subsection. From the **Type** list, choose **Tube**.
- 10 Select the **Radius scale factor** checkbox.
- 11 In the **Tube radius expression** text field, type **0.001**.
- 12 Click to expand the **Quality** section. Find the **ODE solver settings** subsection. In the **Relative tolerance** text field, type **1e-6**.
- 13 In the **Ion Tracing** toolbar, click  **Plot**.

Color the traces using the magnitude of the local force acting on each ion.

Color Expression 1

- 1 Right-click **Particle Tracing with Mass 1** and choose **Color Expression**.
- 2 In the **Settings** window for **Color Expression**, locate the **Expression** section.
- 3 In the **Expression** text field, type $q*vz*mfnc.normB$.
- 4 From the **Unit** list, choose **nN**.
- 5 In the **Ion Tracing** toolbar, click  **Plot**.

Create a new View with a rescaled geometry to better visualize the trajectory of the ions.

DEFINITIONS

Default View

- 1 In the **Model Builder** window, expand the **Component 1 (comp1) > Definitions** node, then click **View 1**.
- 2 In the **Settings** window for **View**, type **Default View** in the **Label** text field.

Scaled View

- 1 In the **Definitions** toolbar, click  **View**.
- 2 In the **Settings** window for **View**, type **Scaled View** in the **Label** text field.

Camera

- 1 In the **Model Builder** window, expand the **Scaled View** node, then click **Camera**.
- 2 In the **Settings** window for **Camera**, locate the **Camera** section.
- 3 From the **View scale** list, choose **Automatic**.

Use the new View in the tracing plot.

RESULTS

Ion Tracing

- 1 In the **Model Builder** window, under **Results** click **Ion Tracing**.
- 2 In the **Settings** window for **3D Plot Group**, locate the **Plot Settings** section.
- 3 From the **View** list, choose **Scaled View**.
- 4 In the **Ion Tracing** toolbar, click  **Plot**.
- 5 Use the **Go to XY View** and **Zoom In** buttons to reproduce the plots in [Figure 4](#).

Finally, specify that the magnetic field plot must use the default view.

Magnetic Field

- 1 In the **Model Builder** window, click **Magnetic Field**.

- 2 In the **Settings** window for **3D Plot Group**, locate the **Plot Settings** section.
- 3 From the **View** list, choose **Default View**.
- 4 In the **Magnetic Field** toolbar, click  **Plot**.