



Model created in COMSOL Multiphysics 6.4

# Deformation of an Iron Plate by Magnetic Force

## *Introduction*

---

A strong permanent magnet is placed close to a clamped thin plate made of iron. The magnetic force causes the plate to be deflected. This example studies the elastic deformation and stress of the plate. The deformation of the plate has an influence on the distribution of the magnetic field. This effect is accounted for using a moving mesh in the air surrounding the plate. The model is set up using the Magnetomechanics, No Currents multiphysics interface.

## *Model Definition*

---

The geometry consists of a permanent magnet and a metal plate surrounded by air.

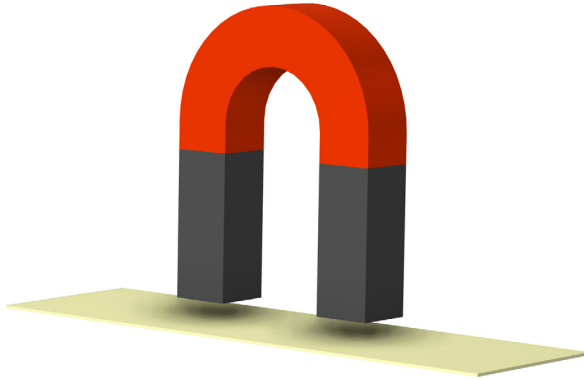
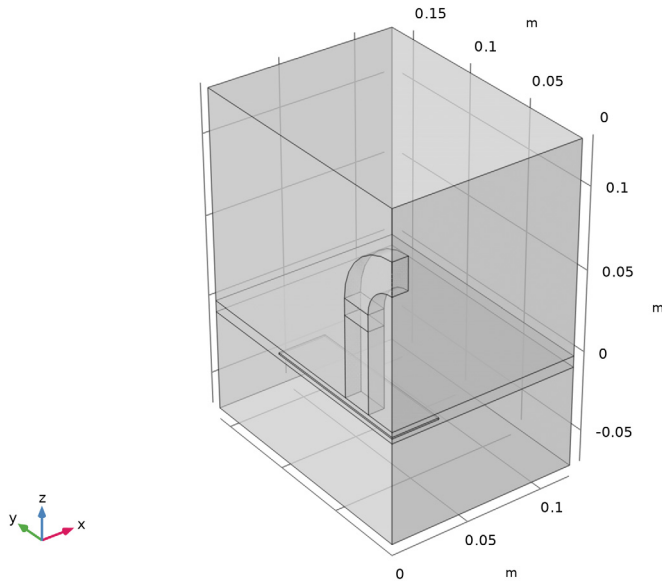

*Figure 1: Full 3D geometry.*

The plate is elastic and made of soft iron with the nonlinear magnetization properties specified as the BH curve shown in [Figure 3](#). The plate initial thickness is 1 mm. Two shorter side boundaries of the plate are fixed and all the other boundaries are free.

The magnet consists of two rectangular N35 magnets connected by a curved piece of iron as shown in [Figure 1](#). The magnet is fixed in space and is not part of the structural analysis.

Because of the symmetry, you can model only one quarter of the magnet and plate. In addition, the magnetic field needs to be computed in the surrounding air using a bounding box shown in [Figure 2](#)



*Figure 2: Model geometry.*

To include the effect of the change of the distance when the plate is deflected by the magnetic field, you set up a moving mesh in a thin layer surrounding the plate, as can be seen in [Figure 2](#). The mesh is free to deform inside the layer, and it can slide on the symmetry cut boundaries.

For the structural problem and the moving mesh, symmetry conditions are used at both symmetry cut planes. However, the magnetic problem needs a symmetry condition on one of the cut planes (on the left in [Figure 2](#)) and an antisymmetry condition on the other one (on the right in [Figure 2](#)).

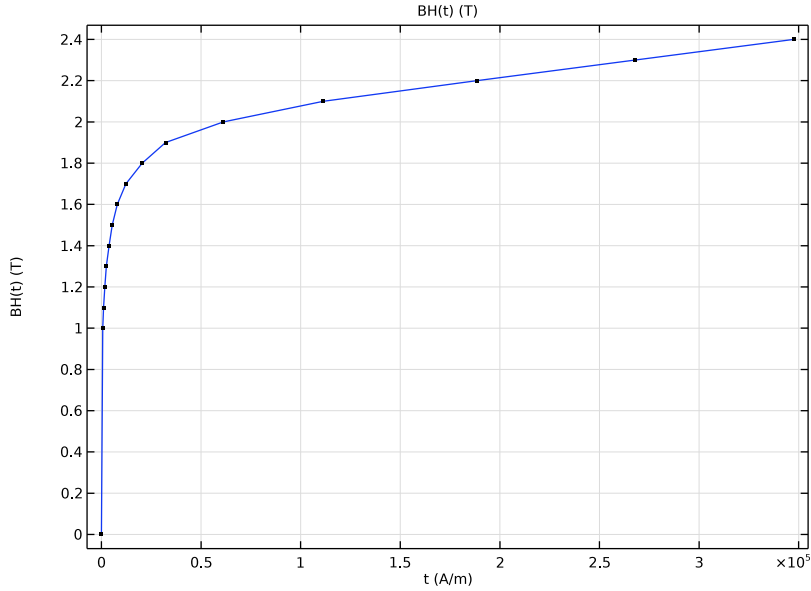

Figure 3: BH curve for soft iron.

## Results and Discussion

---

The magnetic field and plate displacement have been computed for several values of the initial distance,  $d_m$ , between the plate and the magnet poles.

The computation results are visualized for  $d_m = 3$  mm for the full geometry in [Figure 4](#)–[Figure 7](#) by using mirror datasets.

[Figure 4](#) shows that the stress level in the deformed plate is moderate, and it is far below the yield strengths of the material. [Figure 6](#) and [Figure 7](#) show that the magnetic flux density can reach quite significant values, so that certain parts of the plate will be in a magnetization state near the material saturation.

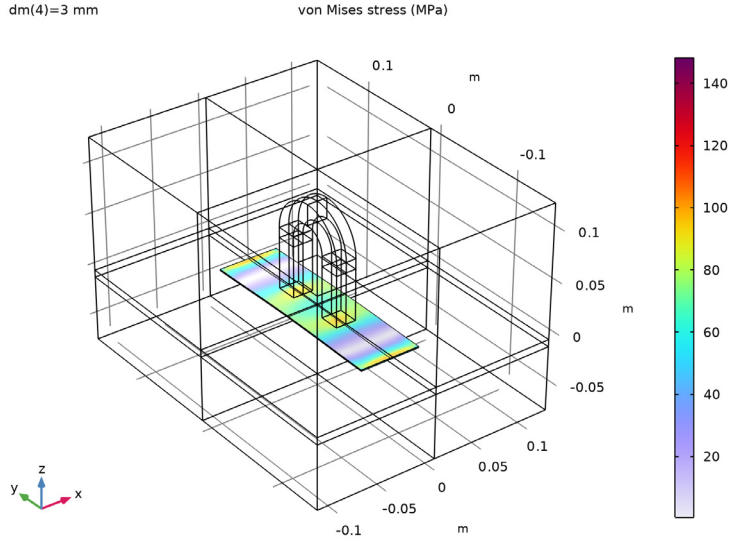

*Figure 4: Stress distribution in the plate for the initial distance of 3 mm to the magnet.*

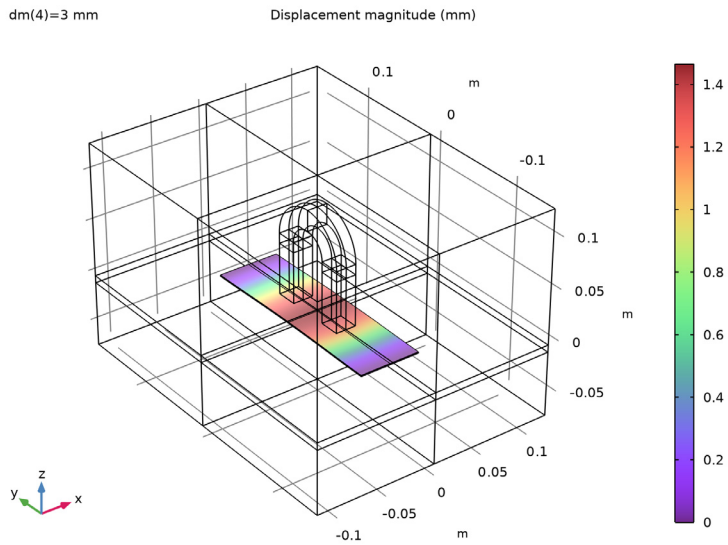

*Figure 5: Displacement of the plate for the initial distance of 3 mm to the magnet.*

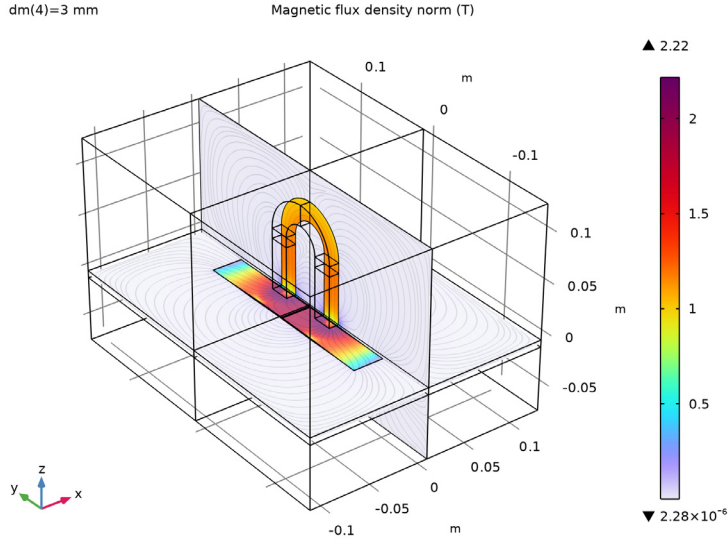

*Figure 6: Magnetic flux density for the initial distance of 3 mm between the plate and magnet.*

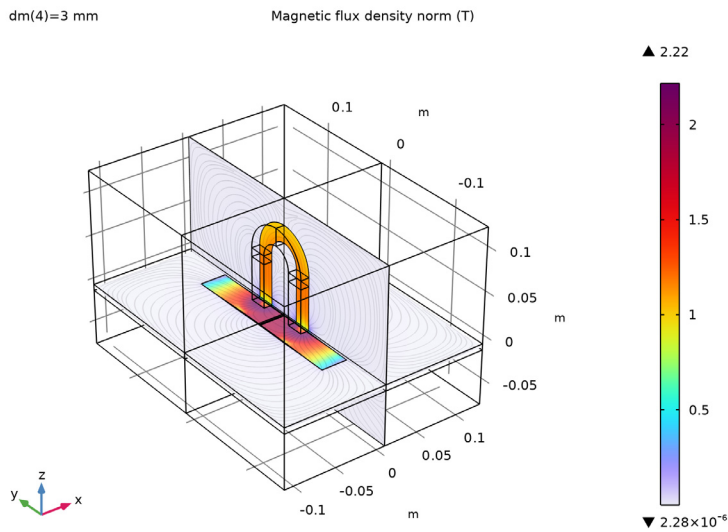

*Figure 7: Magnetic flux density and magnetic flux streamlines in a slice parallel to the plate upper surface for the initial distance of 3 mm between the plate and magnet.*

Figure 8 shows that the relative deflection of the plate can be significant, which justifies the need to use the moving mesh when computing the magnetic field in the surrounding air.

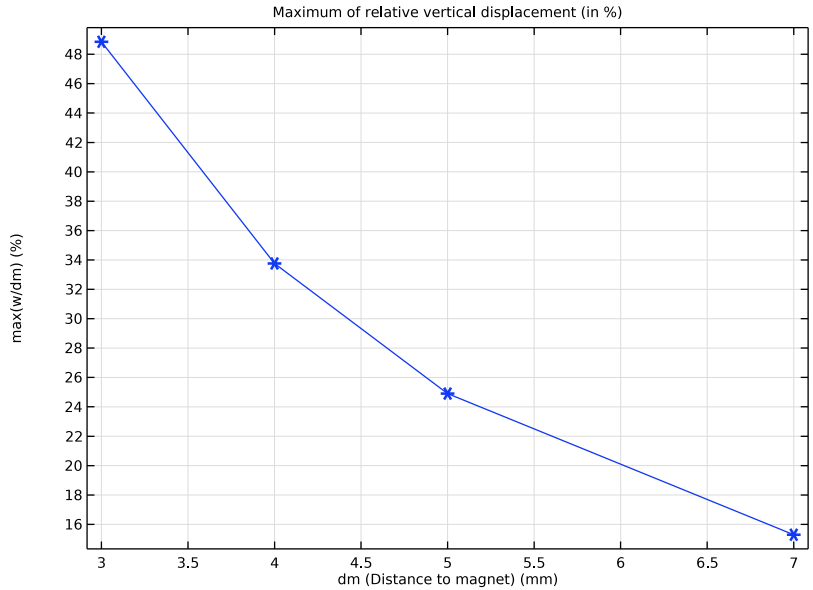
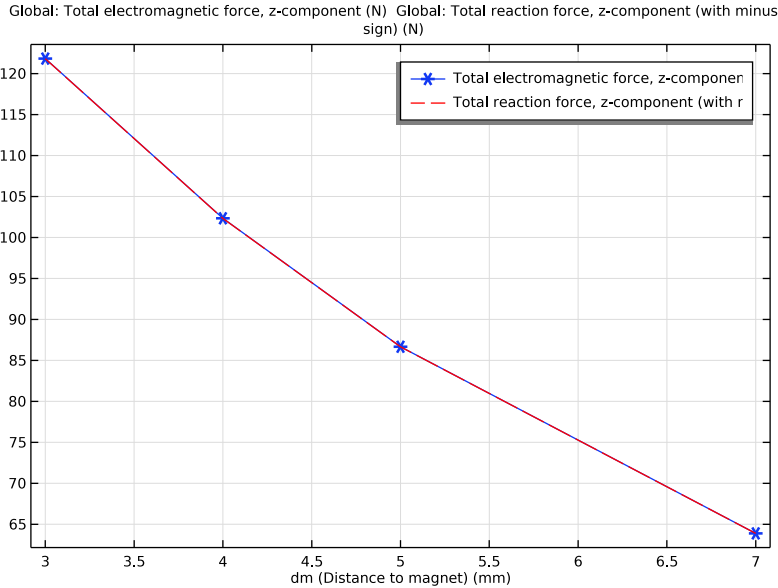

Figure 8: Maximum displacement of the plate in percent of the initial distance between the plate and the magnet poles.

Figure 9 shows very good agreement between the total magnetic pulling force and the total structural reaction force for all studied values of the initial distance between the plate and the magnet poles.



*Figure 9: The total pulling magnetic force and the total structural reaction force (re-computed for the full geometry).*

### *Notes About the COMSOL Implementation*

---

The model is set up using the Magnetomechanics, No Currents multiphysics interface. When this interface is added to a model, one Solid Mechanics and one Magnetic Fields, No Currents physics interface are added automatically together with a Magnetomechanics multiphysics coupling feature. Two moving-mesh-related nodes are also added automatically: a Deforming Domain and a Symmetry/Roller boundary condition.

The magnetic body and surface forces acting on the plate are applied automatically by the coupling feature on its selection. Later on in the modeling, you will also add a Force Calculation node under the Magnetic Fields, No Currents physics interface. The node is only used in postprocessing for computing the total force acting on the plate.

---

**Application Library path:** ACDC\_Module/Electromagnetics\_and\_Mechanics/plate\_deflected\_by\_magnet

---

## Modeling Instructions



---

From the **File** menu, choose **New**.

### NEW

In the **New** window, click  **Model Wizard**.

### MODEL WIZARD

- 1 In the **Model Wizard** window, click .
- 2 In the **Select Physics** tree, select **Structural Mechanics > Electromagnetics–Structure Interaction > Magnetomechanics > Magnetomechanics, No Currents, Solid**.
- 3 Click **Add**.
- 4 Click  **Study**.
- 5 In the **Select Study** tree, select **General Studies > Stationary**.
- 6 Click  **Done**.

### GLOBAL DEFINITIONS

*Parameters, geometry*

- 1 In the **Model Builder** window, under **Global Definitions** click **Parameters I**.
- 2 In the **Settings** window for **Parameters**, type Parameters, geometry in the **Label** text field.
- 3 Locate the **Parameters** section. In the table, enter the following settings:

Name	Expression	Value	Description
dm	3[mm]	0.003 m	Distance to magnet
hp	1[mm]	0.001 m	Plate thickness
lp	20[cm]	0.2 m	Plate length
wp	6[cm]	0.06 m	Plate width
H	7[cm]	0.07 m	Distance to bottom wall

### GEOMETRY I

*Work Plane I (wp1)*

- 1 In the **Geometry** toolbar, click  **Work Plane**.

Use the work plane to set up one quarter of the magnet geometry.

- 2 In the **Settings** window for **Work Plane**, locate the **Plane Definition** section.

- 3 From the **Plane** list, choose **zy-plane**.
- 4 In the **x-coordinate** text field, type 0.01.

*Work Plane 1 (wp1) > Plane Geometry*

In the **Model Builder** window, click **Plane Geometry**.



*Work Plane 1 (wp1) > Circle 1 (c1)*

- 1 In the **Work Plane** toolbar, click  **Circle**.
- 2 In the **Settings** window for **Circle**, locate the **Size and Shape** section.
- 3 In the **Radius** text field, type 0.04.
- 4 In the **Sector angle** text field, type 90.
- 5 Locate the **Position** section. In the **xw** text field, type 0.06.

*Work Plane 1 (wp1) > Circle 2 (c2)*

- 1 Right-click **Component 1 (comp1) > Geometry 1 > Work Plane 1 (wp1) > Plane Geometry > Circle 1 (c1)** and choose **Duplicate**.
- 2 In the **Settings** window for **Circle**, locate the **Size and Shape** section.
- 3 In the **Radius** text field, type 0.02.

*Work Plane 1 (wp1) > Difference 1 (dif1)*

- 1 In the **Work Plane** toolbar, click  **Booleans and Partitions** and choose **Difference**.
- 2 Select the object **c1** only.
- 3 In the **Settings** window for **Difference**, locate the **Difference** section.
- 4 Click to select the  **Activate Selection** toggle button for **Objects to subtract**.
- 5 Select the object **c2** only.

*Work Plane 1 (wp1) > Rectangle 1 (r1)*

- 1 In the **Work Plane** toolbar, click  **Rectangle**.
- 2 In the **Settings** window for **Rectangle**, locate the **Size and Shape** section.
- 3 In the **Width** text field, type 0.05.
- 4 In the **Height** text field, type 0.02.
- 5 Locate the **Position** section. In the **yw** text field, type 0.02.

*Work Plane 1 (wp1) > Rectangle 2 (r2)*

- 1 Right-click **Component 1 (comp1) > Geometry 1 > Work Plane 1 (wp1) > Plane Geometry > Rectangle 1 (r1)** and choose **Duplicate**.
- 2 In the **Settings** window for **Rectangle**, locate the **Size and Shape** section.

- 3 In the **Width** text field, type 0.01.
- 4 Locate the **Position** section. In the **xw** text field, type 0.05.
- 5 Click  **Build Selected**.

*Extrude 1 (ext1)*

- 1 In the **Model Builder** window, under **Component 1 (comp1) > Geometry 1** right-click **Work Plane 1 (wp1)** and choose **Extrude**.
- 2 In the **Settings** window for **Extrude**, locate the **Distances** section.
- 3 In the table, enter the following settings:

<b>Distances (m)</b>
0.01

Add a block representing one quarter of the plate.

*Block 1 (blk1)*

- 1 In the **Geometry** toolbar, click  **Block**.
- 2 In the **Settings** window for **Block**, locate the **Size and Shape** section.
- 3 In the **Width** text field, type  $wp/2$ .
- 4 In the **Depth** text field, type  $lp/2$ .
- 5 In the **Height** text field, type  $hp$ .
- 6 Locate the **Position** section. In the **z** text field, type  $-(dm+hp)$ .

Finally, set up a bounding box for the geometry, which will define the surrounding air domains.

*Block 2 (blk2)*

- 1 In the **Geometry** toolbar, click  **Block**.
- 2 In the **Settings** window for **Block**, locate the **Size and Shape** section.
- 3 In the **Width** text field, type  $2*wp$ .
- 4 In the **Depth** text field, type  $lp/2+wp$ .
- 5 In the **Height** text field, type 0.2.
- 6 Locate the **Position** section. In the **z** text field, type  $-H$ .
- 7 Click to expand the **Layers** section. Specify two layers to define the domain, where a moving mesh will be used.

8 In the table, enter the following settings:

Layer name	Thickness (m)
Layer 1	$H - 2 * d_m - h_p$
Layer 2	$2 * d_m + h_p$

9 Click  **Build All Objects**.

10 Click the  **Transparency** button in the **Graphics** toolbar.

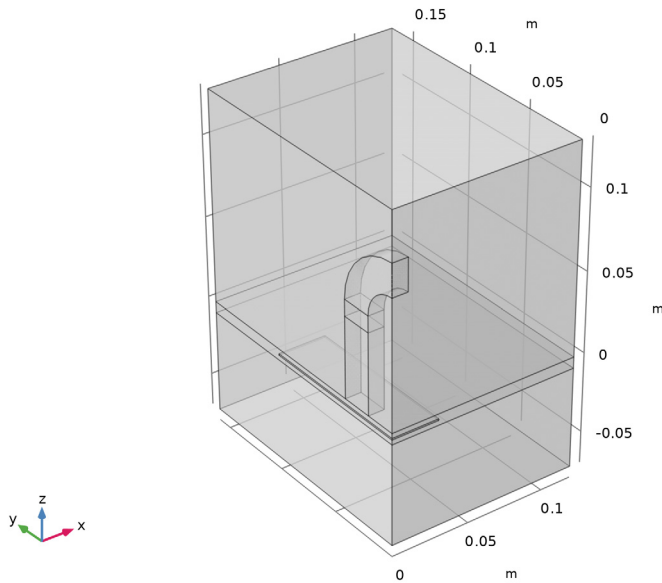

#### ADD MATERIAL

1 In the **Materials** toolbar, click  **Add Material** to open the **Add Material** window.

2 Go to the **Add Material** window.

Add the plate and magnet materials. The plate and the curved handle of the magnet are made of soft iron. The rectangular magnet is made of N35 (Sintered NdFeB).

3 In the tree, select **AC/DC > Soft Iron (Without Losses)**.

4 Right-click and choose **Add to Component 1 (comp1)**.

## MATERIALS

*Soft Iron (Without Losses) (mat1)*

- 1 In the **Model Builder** window, under **Component 1 (comp1) > Materials** click **Soft Iron (Without Losses) (mat1)**.
- 2 In the **Settings** window for **Material**, locate the **Geometric Entity Selection** section.
- 3 From the **Selection** list, choose **Manual**.
- 4 Click  **Clear Selection**.
- 5 Select Domains 3, 5, and 7 only.

## ADD MATERIAL

- 1 Go to the **Add Material** window.
- 2 In the tree, select **AC/DC > Hard Magnetic Materials > Sintered NdFeB Grades (Chinese Standard) > N35 (Sintered NdFeB)**.
- 3 Right-click and choose **Add to Component 1 (comp1)**.

## MATERIALS

*N35 (Sintered NdFeB) (mat2)*

- 1 In the **Model Builder** window, under **Component 1 (comp1) > Materials** click **N35 (Sintered NdFeB) (mat2)**.
- 2 Select Domain 6 only.

Use air in the surrounding domains.

## ADD MATERIAL

- 1 Go to the **Add Material** window.
- 2 In the tree, select **Built-in > Air**.
- 3 Right-click and choose **Add to Component 1 (comp1)**.
- 4 In the **Materials** toolbar, click  **Add Material** to close the **Add Material** window.

## MATERIALS

*Air (mat3)*

Select Domains 1, 2, and 4 only.

Set up moving mesh in the air domain surrounding the plate.

## MOVING MESH

### *Deforming Domain 1*

- 1 In the **Model Builder** window, under **Component 1 (comp1) > Moving Mesh** click **Deforming Domain 1**.
- 2 Select Domain 2 only.

Allow the mesh to slide on the boundaries representing the symmetry cuts.

### *Symmetry/Roller 1*

- 1 In the **Model Builder** window, click **Symmetry/Roller 1**.
- 2 Select Boundaries 4 and 5 only.

Perform the structural analysis only in the domain representing the plate.

## SOLID MECHANICS (SOLID)

- 1 In the **Model Builder** window, under **Component 1 (comp1)** click **Solid Mechanics (solid)**.
- 2 Select Domain 3 only.

### *Fixed Constraint 1*

- 1 In the **Physics** toolbar, click  **Boundaries** and choose **Fixed Constraint**.

One side boundary of the plate is fixed.

- 2 Select Boundary 29 only.

Two external side boundaries represent the symmetry cuts.

### *Symmetry 1*

- 1 In the **Physics** toolbar, click  **Boundaries** and choose **Symmetry**.

- 2 Select Boundaries 7 and 8 only.

## MAGNETIC FIELDS, NO CURRENTS (MFNC)

### *Magnetic Flux Conservation in Solids 1*

The plate and the curved part connecting the magnet poles are made of iron that has nonlinear magnetization properties, including possible saturation.

- 1 In the **Model Builder** window, under **Component 1 (comp1) > Magnetic Fields, No Currents (mfnc)** click **Magnetic Flux Conservation in Solids 1**.
- 2 Select Domains 3, 5, and 7 only.
- 3 In the **Settings** window for **Magnetic Flux Conservation in Solids**, locate the **Constitutive Relation B-H** section.

- 4 From the **Magnetization model** list, choose **B-H curve**.

*Magnetic Flux Conservation, Magnet*

- 1 In the **Physics** toolbar, click  **Domains** and choose **Magnetic Flux Conservation in Solids**.



You model the magnet using the remanent flux density defined by the material.

- 2 In the **Settings** window for **Magnetic Flux Conservation in Solids**, type Magnetic Flux Conservation, Magnet in the **Label** text field.
- 3 Select Domain 6 only.
- 4 Locate the **Constitutive Relation B-H** section. From the **Magnetization model** list, choose **Remanent flux density**.
- 5 Specify the **e** vector as

0	X
0	Y
1	Z

Next, define the conditions on the boundaries representing the symmetry cuts. Note that two different types of conditions are needed.



*Symmetry Plane, Symmetry*

- 1 In the **Physics** toolbar, click  **Boundaries** and choose **Symmetry Plane**.
- 2 In the **Settings** window for **Symmetry Plane**, type Symmetry Plane, Symmetry in the **Label** text field.
- 3 Locate the **Boundary Selection** section. Click  **Paste Selection**.
- 4 In the **Paste Selection** dialog, You can use the *Paste Selection* dialog to manually specify your selections.
- 5 type 1, 4, 7, 11, 14, 17, 20, 23 in the **Selection** text field.

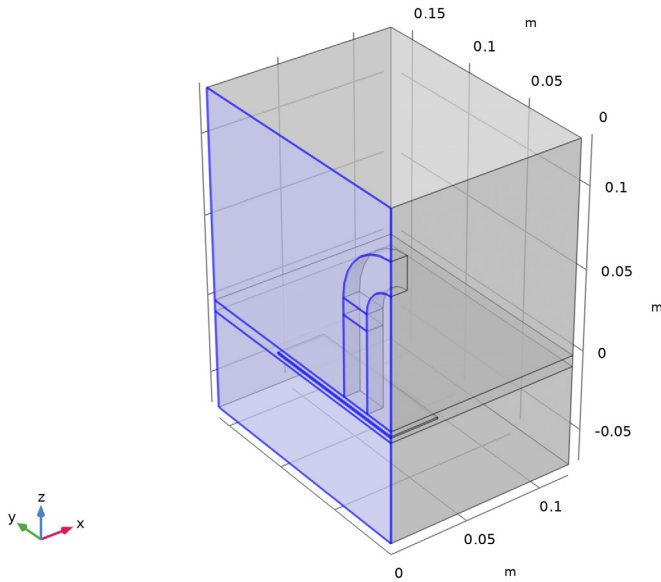
6 Click **OK**.



#### *Symmetry Plane, Antisymmetry*

- 1 In the **Physics** toolbar, click  **Boundaries** and choose **Symmetry Plane**.
- 2 In the **Settings** window for **Symmetry Plane**, type Symmetry Plane, Antisymmetry in the **Label** text field.
- 3 Locate the **Symmetry Plane** section. From the **Symmetry type for the magnetic field** list, choose **Antisymmetry**.
- 4 Locate the **Boundary Selection** section. Click  **Paste Selection**.
- 5 In the **Paste Selection** dialog, type 2, 5, 8, 12, 15 in the **Selection** text field.

6 Click **OK**.

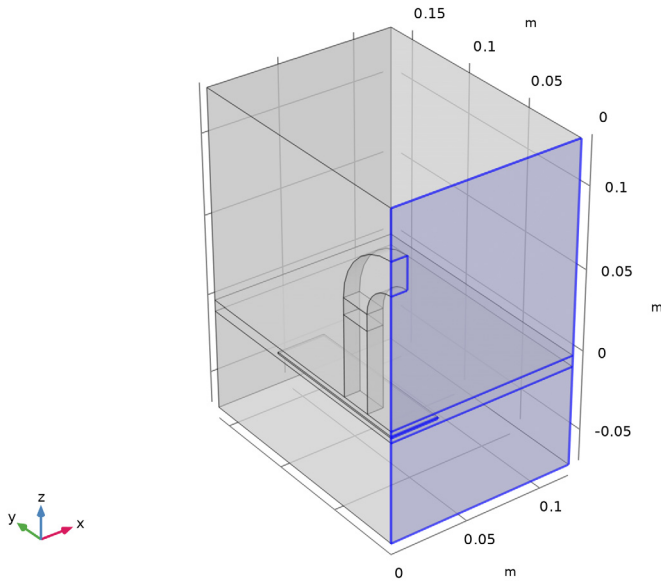

## MATERIALS

*Soft Iron (Without Losses) (mat1)*

- 1 In the **Model Builder** window, under **Component 1 (comp1) > Materials** click **Soft Iron (Without Losses) (mat1)**.
- 2 In the **Settings** window for **Material**, locate the **Material Contents** section.
- 3 In the table, enter the following settings:

Property	Variable	Value	Unit	Property group
Young's modulus	E	200 [GPa]	Pa	Young's modulus and Poisson's ratio
Poisson's ratio	nu	0.29	l	Young's modulus and Poisson's ratio
Density	rho	7870 [kg/m <sup>3</sup> ]	kg/m <sup>3</sup>	Basic

Define a few parameters to control the meshing of the geometry.

## GLOBAL DEFINITIONS

*Parameters, accuracy*



- 1 In the **Home** toolbar, click  **Parameters** and choose **Add > Parameters**.
- 2 In the **Settings** window for **Parameters**, type Parameters, accuracy in the **Label** text field.
- 3 Locate the **Parameters** section. In the table, enter the following settings:

Name	Expression	Value	Description
ap	0	0	Accuracy parameter: 0 - normal, 1 - high
hmax1	$5[\text{mm}] - 2.6[\text{mm}] * \text{ap}$	0.005 m	Meshing parameter
hmax2	$20[\text{mm}] - 10[\text{mm}] * \text{ap}$	0.02 m	Meshing parameter

Use swept meshes in the domains representing the plate and magnet. Start by meshing two respective adjacent surfaces.

## MESH I

*Free Triangular I*

- 1 In the **Mesh** toolbar, click  **More Generators** and choose **Free Triangular**.
- 2 In the **Settings** window for **Free Triangular**, locate the **Boundary Selection** section.
- 3 Click  **Paste Selection**.
- 4 In the **Paste Selection** dialog, type 10, 22 in the **Selection** text field.

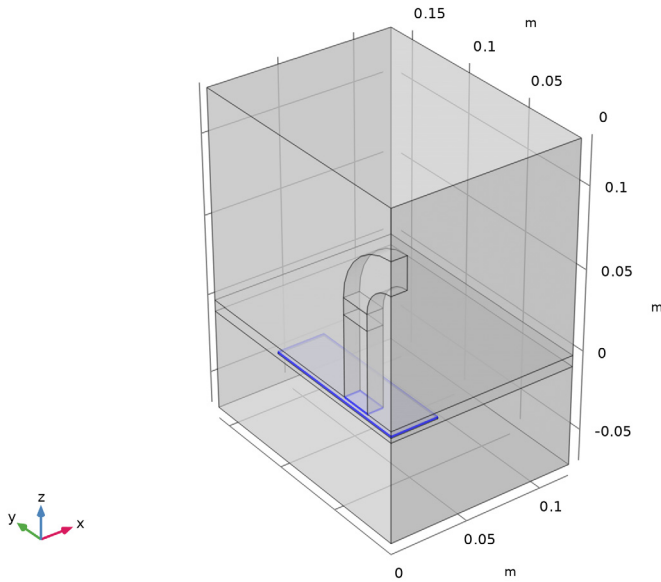

5 Click **OK**.



#### *Size 1*

- 1 Right-click **Free Triangular 1** and choose **Size**.
- 2 In the **Settings** window for **Size**, locate the **Element Size** section.
- 3 Click the **Custom** button.
- 4 Locate the **Element Size Parameters** section.
- 5 Select the **Maximum element size** checkbox. In the associated text field, type `hmax1`.

#### *Swept 1*

- 1 In the **Mesh** toolbar, click  **Swept**.  
The first swept mesh will be applied to the magnet. This will then be adjusted using two distributions applied to the different domains of the magnet.
- 2 In the **Settings** window for **Swept**, locate the **Domain Selection** section.
- 3 From the **Geometric entity level** list, choose **Domain**.
- 4 Click  **Paste Selection**.
- 5 In the **Paste Selection** dialog, type `5-7` in the **Selection** text field.

6 Click **OK**.

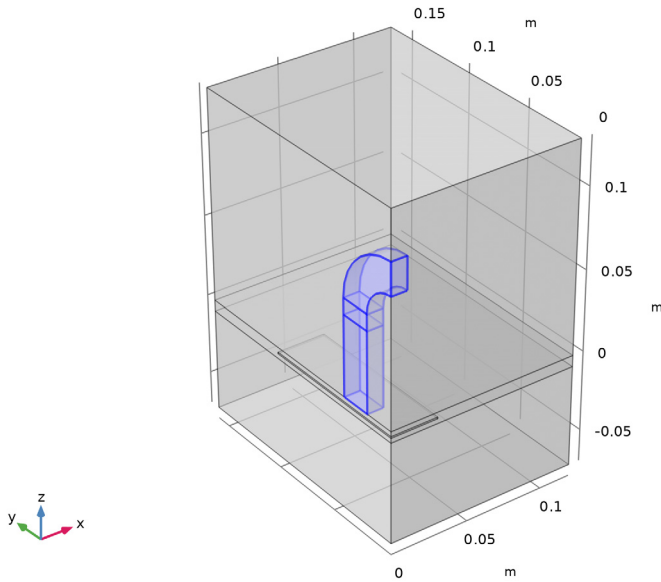

#### *Distribution 1*

- 1 Right-click **Swept 1** and choose **Distribution**.
- 2 In the **Settings** window for **Distribution**, locate the **Domain Selection** section.
- 3 In the list box, select **7**.
- 4 Click **Remove from Selection**.  
Only domains 5 and 6 are used for this distribution.
- 5 Locate the **Distribution** section. In the **Number of elements** text field, type 10.

#### *Distribution 2*

- 1 In the **Model Builder** window, right-click **Swept 1** and choose **Distribution**.
- 2 Select Domain 7 only.
- 3 In the **Settings** window for **Distribution**, locate the **Distribution** section.
- 4 In the **Number of elements** text field, type 2.

#### *Swept 2*

- 1 In the **Mesh** toolbar, click **Swept**.  
A second swept mesh is then applied to the metal plate.

- 2 In the **Settings** window for **Swept**, locate the **Domain Selection** section.
- 3 From the **Geometric entity level** list, choose **Domain**.
- 4 Select Domain 3 only.

#### *Distribution 1*

- 1 Right-click **Swept 2** and choose **Distribution**.
- 2 In the **Settings** window for **Distribution**, locate the **Distribution** section.
- 3 In the **Number of elements** text field, type 3.

Mesh the rest of the geometry using a free tetrahedral mesh.

#### *Free Tetrahedral 1*

In the **Mesh** toolbar, click  **Free Tetrahedral**.

#### *Size 1*

- 1 Right-click **Free Tetrahedral 1** and choose **Size**.
- 2 In the **Settings** window for **Size**, locate the **Element Size** section.
- 3 Click the **Custom** button.
- 4 Locate the **Element Size Parameters** section.
- 5 Select the **Maximum element size** checkbox. In the associated text field, type  $h_{max2}$ .

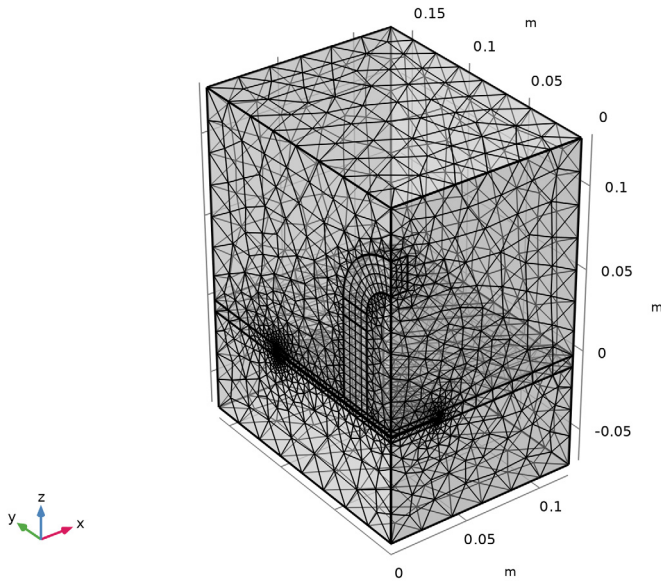

6 Click  **Build All**.



Set up a parametric sweep to study cases of several different distances between the plate and magnet.

### STUDY I

#### Parametric Sweep

- 1 In the **Study** toolbar, click  **Parametric Sweep**.
- 2 In the **Settings** window for **Parametric Sweep**, locate the **Study Settings** section.
- 3 Click  **Add**.
- 4 In the table, enter the following settings:

Parameter name	Parameter value list	Parameter unit
dm (Distance to magnet)	7 5 4 3	mm

Modify the default solver to reduce the solving time and to improve the numerical stability.

#### Solution I (sol1)

- 1 In the **Study** toolbar, click  **Show Default Solver**.
- 2 In the **Model Builder** window, expand the **Solution I (sol1)** node.

- 3 In the **Model Builder** window, expand the **Study 1 > Solver Configurations > Solution 1 (sol1) > Stationary Solver 1 > Segregated 1** node, then click **Magnetic Potential**.
- 4 In the **Settings** window for **Segregated Step**, locate the **General** section.
- 5 From the **Linear solver** list, choose **Direct**.  
Prepare a plot to be shown during the parametric sweep computation.
- 6 In the **Study** toolbar, click  **Show Default Plots**.

#### *Parametric Sweep*

- 1 In the **Model Builder** window, under **Study 1** click **Parametric Sweep**.
- 2 In the **Settings** window for **Parametric Sweep**, locate the **Output While Solving** section.
- 3 Select the **Plot** checkbox.
- 4 In the **Study** toolbar, click  **Compute**.

## **RESULTS**

#### *Stress (solid)*

Set up datasets to visualize the results for the full geometry. Note that two different types of datasets will be needed to show the magnetic fields and structural quantities.

#### *Mirror 3D, symmetry yz-plane*

- 1 In the **Results** toolbar, click  **More Datasets** and choose **Mirror 3D**.
- 2 In the **Settings** window for **Mirror 3D**, type **Mirror 3D, symmetry yz-plane** in the **Label** text field.
- 3 Locate the **Data** section. From the **Dataset** list, choose **Study 1/ Parametric Solutions 1 (sol2)**.

#### *Mirror 3D, symmetry xz-plane*

- 1 In the **Results** toolbar, click  **More Datasets** and choose **Mirror 3D**.
- 2 In the **Settings** window for **Mirror 3D**, locate the **Data** section.
- 3 From the **Dataset** list, choose **Mirror 3D, symmetry yz-plane**.
- 4 In the **Label** text field, type **Mirror 3D, symmetry xz-plane**.
- 5 Locate the **Plane Data** section. From the **Plane** list, choose **xz-planes**.

#### *Mirror 3D, antisymmetry xz-plane*

- 1 Right-click **Mirror 3D, symmetry xz-plane** and choose **Duplicate**.
- 2 In the **Settings** window for **Mirror 3D**, click to expand the **Advanced** section.

- 3 Find the **Space variables** subsection. From the **Vector transformation** list, choose **Antisymmetric**.
- 4 In the **Label** text field, type **Mirror 3D, antisymmetry xz-plane**.

#### *Study I/Parametric Solutions I (sol2)*

- 1 In the **Model Builder** window, click **Study I/Parametric Solutions I (sol2)**.
- 2 In the **Settings** window for **Solution**, locate the **Solution** section.
- 3 From the **Frame** list, choose **Material (X, Y, Z)**.

#### *Stress (solid)*

- 1 In the **Model Builder** window, under **Results** click **Stress (solid)**.
- 2 In the **Settings** window for **3D Plot Group**, locate the **Data** section.
- 3 From the **Dataset** list, choose **Mirror 3D, symmetry xz-plane**.

#### *Volume I*

- 1 In the **Model Builder** window, expand the **Stress (solid)** node, then click **Volume I**.
- 2 In the **Settings** window for **Volume**, locate the **Expression** section.
- 3 From the **Unit** list, choose **MPa**.

#### *Deformation I*

- 1 Right-click **Volume I** and choose **Deformation**.
- 2 In the **Settings** window for **Deformation**, locate the **Scale** section.
- 3 Select the **Scale factor** checkbox. In the associated text field, type 1.
- 4 In the **Stress (solid)** toolbar, click  **Plot**.

#### *Magnetic Flux Density (mfnc)*

- 1 In the **Model Builder** window, under **Results** click **Magnetic Flux Density (mfnc)**.
- 2 In the **Settings** window for **3D Plot Group**, locate the **Data** section.
- 3 From the **Dataset** list, choose **Mirror 3D, antisymmetry xz-plane**.

#### *Multislice I*

- 1 In the **Model Builder** window, expand the **Magnetic Flux Density (mfnc)** node, then click **Multislice I**.
- 2 In the **Settings** window for **Multislice**, locate the **Multiplane Data** section.
- 3 Find the **x-planes** subsection. In the **Coordinates** text field, type 0.
- 4 Find the **y-planes** subsection. Clear the **Coordinates** text field.
- 5 Find the **z-planes** subsection. In the **Coordinates** text field, type  $-dm*1.1$ .

### *Streamline Multislice 1*

- 1 In the **Model Builder** window, click **Streamline Multislice 1**.
- 2 In the **Settings** window for **Streamline Multislice**, locate the **Multipane Data** section.
- 3 Find the **x-planes** subsection. In the **Coordinates** text field, type 0.
- 4 Find the **y-planes** subsection. Clear the **Coordinates** text field.
- 5 Find the **z-planes** subsection. In the **Coordinates** text field, type  $-dm*1.1$ .
- 6 Locate the **Streamline Positioning** section. In the **Density level** text field, type 8.5.
- 7 In the **Magnetic Flux Density (mfnc)** toolbar, click  **Plot**.

Plot the structural displacement magnitude in the plate.

### *Displacement (solid)*

- 1 In the **Model Builder** window, right-click **Stress (solid)** and choose **Duplicate**.
- 2 In the **Settings** window for **3D Plot Group**, type Displacement (solid) in the **Label** text field.

### *Volume 1*

- 1 In the **Model Builder** window, expand the **Displacement (solid)** node, then click **Volume 1**.
- 2 In the **Settings** window for **Volume**, locate the **Expression** section.
- 3 In the **Expression** text field, type `solid.disp`.
- 4 From the **Unit** list, choose **mm**.
- 5 Locate the **Coloring and Style** section. From the **Color table** list, choose **SpectrumLight**.
- 6 In the **Displacement (solid)** toolbar, click  **Plot**.

Evaluate the maximum structural displacement and the total force acting on the plate.

## **DEFINITIONS**

### *Maximum 1 (maxop1)*

- 1 In the **Definitions** toolbar, click  **Nonlocal Couplings** and choose **Maximum**.
- 2 Select Domain 3 only.

## **MAGNETIC FIELDS, NO CURRENTS (MFNC)**

### *Force Calculation, for Postprocessing*

- 1 In the **Physics** toolbar, click  **Domains** and choose **Force Calculation**.
- 2 In the **Settings** window for **Force Calculation**, type Force Calculation, for Postprocessing in the **Label** text field.

- 3 Select Domain 3 only.
- 4 Locate the **Force Calculation** section. From the **Force calculation method** list, choose **No force on contact**.

## STUDY I

In the **Study** toolbar, click  **Update Solution**.

## RESULTS

### *Maximum displacement*

- 1 In the **Results** toolbar, click  **ID Plot Group**.
- 2 In the **Settings** window for **ID Plot Group**, type Maximum displacement in the **Label** text field.
- 3 Locate the **Data** section. From the **Dataset** list, choose **Study I/ Parametric Solutions I (sol2)**.
- 4 Click to expand the **Title** section. From the **Title type** list, choose **Manual**.
- 5 In the **Title** text area, type Maximum of relative vertical displacement (in %).
- 6 Locate the **Legend** section. Clear the **Show legends** checkbox.

### *Global I*

- 1 Right-click **Maximum displacement** and choose **Global**.
- 2 In the **Settings** window for **Global**, locate the **y-Axis Data** section.
- 3 In the table, enter the following settings:

Expression	Unit	Description
maxop1 (w/dm)	%	max (w/dm)

- 4 Click to expand the **Coloring and Style** section. Find the **Line markers** subsection. From the **Marker** list, choose **Cycle**.
- 5 In the **Maximum displacement** toolbar, click  **Plot**.

### *Total force*

- 1 In the **Results** toolbar, click  **ID Plot Group**.
- 2 In the **Settings** window for **ID Plot Group**, type Total force in the **Label** text field.
- 3 Locate the **Data** section. From the **Dataset** list, choose **Study I/ Parametric Solutions I (sol2)**.

### Global 1

- 1 Right-click **Total force** and choose **Global**.
- 2 In the **Settings** window for **Global**, click **Replace Expression** in the upper-right corner of the **y-Axis Data** section. From the menu, choose **Component I (comp1) > Magnetic Fields, No Currents > Mechanical > Electromagnetic force (spatial frame) - N > mfnc.Forcez\_1 - Electromagnetic force, z-component**.
- 3 Locate the **y-Axis Data** section. In the table, enter the following settings:

Expression	Unit	Description
4*mfnc.Forcez_1	N	Total electromagnetic force, z-component

- 4 Locate the **Coloring and Style** section. Find the **Line markers** subsection. From the **Marker** list, choose **Cycle**.

### Global 2

- 1 In the **Model Builder** window, right-click **Total force** and choose **Global**.
- 2 In the **Settings** window for **Global**, click **Replace Expression** in the upper-right corner of the **y-Axis Data** section. From the menu, choose **Component I (comp1) > Solid Mechanics > Reactions > Total reaction force (spatial frame) - N > solid.RFtotalz - Total reaction force, z-component**.
- 3 Locate the **y-Axis Data** section. In the table, enter the following settings:

Expression	Unit	Description
-4*solid.RFtotalz	N	Total reaction force, z-component (with minus sign)

- 4 Locate the **Coloring and Style** section. Find the **Line style** subsection. From the **Line** list, choose **Dashed**.
- 5 From the **Color** list, choose **Red**.
- 6 In the **Total force** toolbar, click  **Plot**.