



Model created in COMSOL Multiphysics 6.4

Magnetotellurics

Introduction

Magnetotellurics (MT) is a method for estimating the electric resistivity (or the reciprocal electric conductivity) profile of the Earth's crust using the natural electromagnetic source provided by the ionosphere.

The resistivity of the Earth's crust may vary over several orders of magnitude and gives a strong indication as to what kind of rocks are present. Metamorphic, igneous, or sedimentary rocks might have resistivities varying from 0.1 to $10^5 \Omega\text{m}$, depending on several petrophysical parameters.

The electromagnetic source in the MT method has its origin in the variations in the magnetic field of the Earth, caused by solar wind and electromagnetic noise. These variations induce electric currents in the Earth's crust, proportional to the electric conductivity.

The electromagnetic source is random by nature, but nevertheless, the low frequency signals and the shape of the ionosphere generate plane-wave components that can be correlated over large areas. By simultaneous measurements of the natural source electromagnetic field as a function of time at different locations in an area of interest, one can statistically extract the local electromagnetic impedance as a function of frequency. This impedance can then be used to estimate the electric resistivity (or conductivity) as a function of depth.

This application is inspired by a study published in 1997 ([Ref. 1](#)). In that article, various scientific groups compared the software performance of a few models. This model, called COMMEMI-3D-2, has become one of the benchmarks for MT modeling.

IMPEDANCE TENSOR

MT analysis is based on the impedance tensor \mathbf{Z} defined as

$$\mathbf{E} = \mathbf{Z} \cdot \mathbf{H}$$

here, \mathbf{H} is the magnetic field and \mathbf{E} denotes the electric field.

Normally, only the horizontal components of the fields are analyzed since the incident field is a plane-wave parallel to the Earth's surface. When the z direction is the vertical axis, the relation for the horizontal components reads

$$\begin{bmatrix} E_x \\ E_y \end{bmatrix} = \begin{bmatrix} Z_{xx} & Z_{xy} \\ Z_{yx} & Z_{yy} \end{bmatrix} \begin{bmatrix} H_x \\ H_y \end{bmatrix}$$

The impedance tensor components are then analyzed to determine the electric properties of the subsurface. For example, if the subsurface can be approximated with a 1D model (resistivity variations as a function of depth), the following relations follow:

$$Z_{xx} = Z_{yy} = 0$$

$$Z_{xy} = -Z_{yx}$$

If the subsurface can be approximated with a 2D structure and the electric field is parallel to the strike (the axis in the horizontal plane along which the resistivity is constant), the mode is called transverse electric (TE). If the magnetic field is oriented along the strike, the mode is called transverse magnetic (TM). These two modes are uncoupled. Assuming that the x -axis is oriented along the strike, the impedance matrix component Z_{xy} corresponds to the TE mode and Z_{yx} describes the TM mode. In a 2D approximation, the impedance tensor's components are

$$Z_{xx} = Z_{yy} = 0$$

and

$$Z_{xy} \neq Z_{yx}$$

In the general 3D case, the diagonal components Z_{xx} and Z_{yy} are different and nonzero. These diagonal matrix elements are often analyzed to determine the dimensionality of the subsurface.

Traditionally, MT surveys are performed using electromagnetic sensors that are placed on the sea bottom or on land forming either lines or grids. The alignment of the sensors is often such that the line is perpendicular to the expected strike of the formation, such as a fault line.

In a right-handed coordinate system with the z -axis pointing downward from the surface of the model, the TE and TM modes relative to the coordinate system are then related to the impedance tensor, meaning that $Z_{TE} = Z_{xy}$ and $Z_{TM} = Z_{yx}$. By positioning the sensors along a line perpendicular to the strike, the sensitivity is increased by measuring the biggest differences in induced currents across and parallel to the strike.

APPARENT RESISTIVITY

When modeling MT with a known source, and the applied magnetic field is aligned along the y -axis, the apparent resistivity components are calculated from

$$\rho_{xy} = \frac{1}{\omega\mu} \left| \frac{E_x}{H_y} \right|^2, \phi_{xy} = \arg\left(\frac{E_x}{H_y}\right)$$

$$\rho_{yy} = \frac{1}{\omega\mu} \left| \frac{E_y}{H_y} \right|^2, \phi_{yy} = \arg\left(\frac{E_y}{H_y}\right)$$

and the components in the impedance tensor are

$$z_{xy} = \rho_{xy} e^{i\phi_{xy}}$$

$$z_{yy} = \rho_{yy} e^{i\phi_{yy}}$$

Also, when the applied magnetic field is aligned along the x -axis, the apparent resistivity components are calculated from

$$\rho_{yx} = \frac{1}{\omega\mu} \left| \frac{E_y}{H_x} \right|^2, \phi_{yx} = \arg\left(\frac{E_y}{H_x}\right)$$

$$\rho_{xx} = \frac{1}{\omega\mu} \left| \frac{E_x}{H_x} \right|^2, \phi_{xx} = \arg\left(\frac{E_x}{H_x}\right)$$

and the components of the impedance tensor are

$$z_{yx} = \rho_{yx} e^{i\phi_{yx}}$$

$$z_{xx} = \rho_{xx} e^{i\phi_{xx}}$$

Therefore, in order to determine all the components of the impedance tensor \mathbf{Z} , two simulations must be run with two different field polarizations.

Model Definition

The geometry and parameters for this application are taken from [Ref. 1](#). Two rectangular inserts of high conductivity are placed in the upper layer of a three-layer earth. The main idea of the study is to estimate those conductivities by the MT method.

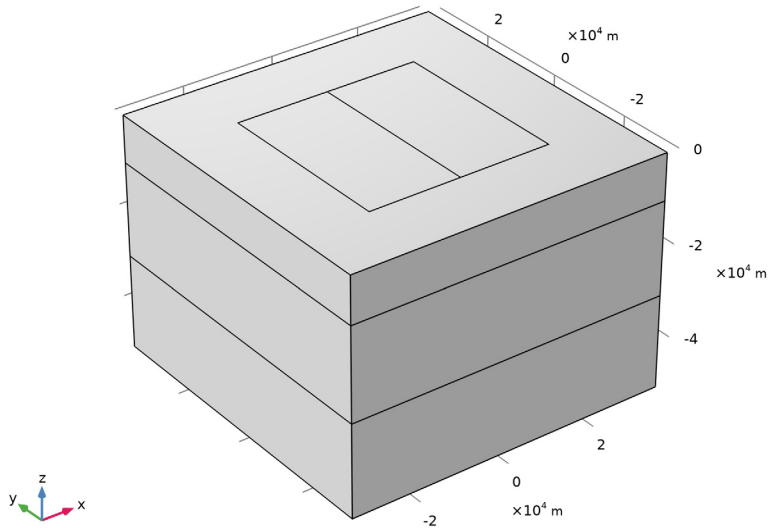

Figure 1: A 70 by 70 km piece of Earth's crust, consisting of three layers of different conductivities. From top to bottom, the conductivities are 10, 100, and 0.1 Ωm . The upper layer has two rectangular inserts of conductivities 1 and 100 Ωm .

The application uses the Magnetic Fields interface in a 3D geometry. The magnetic field source is a plane wave that induces horizontal currents in the whole model. You impose suitable symmetry boundary conditions on the lateral sides to simulate an infinite domain. This assumption holds well if the domain is large enough around the area of interest. Make the computational domain larger if boundary effects are present. The imposed magnetic field is parallel or perpendicular to these boundaries depending on the chosen polarization.

The magnetotellurics analysis is based on the decomposition of the incoming plane waves into two waves with perpendicular polarizations. Hence, you solve these two polarizations in two independent physics interfaces. Then you solve the two physics interfaces in a single solver sequence to get all results in a single dataset. The solutions from the two polarizations can thus be obtained by a parametric sweep over several frequencies.

Results and Discussion

The components of the apparent resistivity can now be extracted from the top layer of the model and plotted as surface plots for each frequency. This is where the measurements are

made when real data is collected in magnetotelluric surveys. As discussed earlier, the apparent resistivity at a certain position is equal to the resistivity below it in the case of a uniform half-space (1D model).

Because the skin depth is small at high frequencies, the values of the apparent resistivity should be equal to the material resistivity in areas where a half-space approximation is valid. This can be seen in [Figure 2](#) and [Figure 3](#). In the areas with uniform resistivities, far from the “fault lines,” the apparent resistivity is almost equal to the resistivity of the material right underneath.

For a magnetotelluric survey, the electromagnetic sensors are usually deployed along a line perpendicular to the expected fault line. Then, the apparent resistivity at a given frequency is plotted as a function of position along the line. See [Figure 4](#) where data is extracted along a line crossing the three fault lines in the model. The results in this plot are comparable with the results published in the reference article ([Ref. 1](#)).

At lower frequencies, the discrepancy between the apparent resistivity and the material resistivity values increases.

Some magnetotellurics surveys also measure the z -component of the magnetic field. The plot of H_z is called the *tipper* plot. A rule of thumb is that a nonzero value of the tipper indicates a large change in resistivity from one side of a fault line to another. When moving along the direction of the field vector at a given phase value, the sign of the tipper indicates if one is moving from a region of higher resistivity to a low resistivity region (tipper is positive) or the opposite (tipper is negative). See [Figure 6](#) where the tipper has been plotted on the domain, for the frequency of 0.01 Hz.

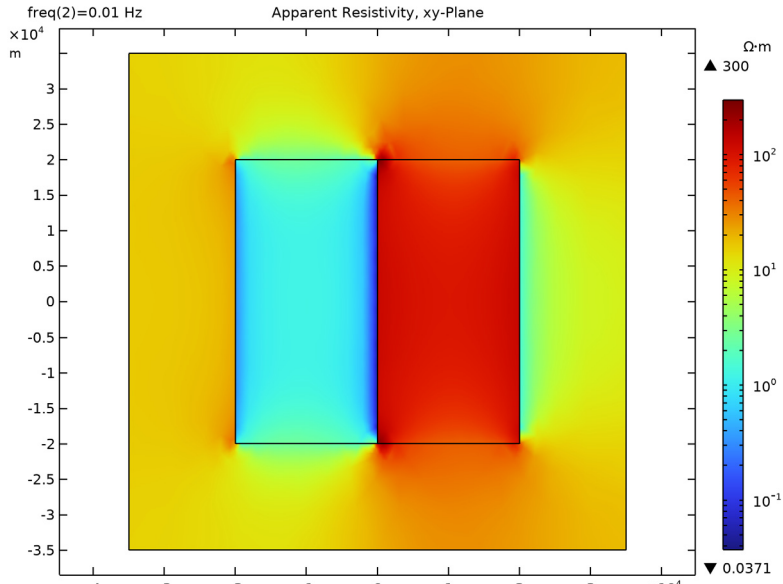

Figure 2: Logarithm of apparent resistivity ρ_{xy} , top view of the 3D domain.

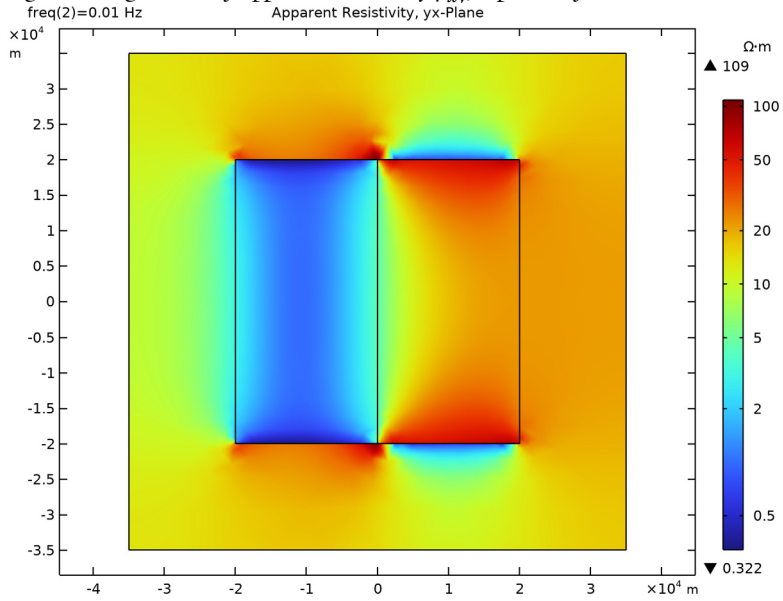

Figure 3: Logarithm of apparent resistivity ρ_{yx} , top view of the 3D domain.

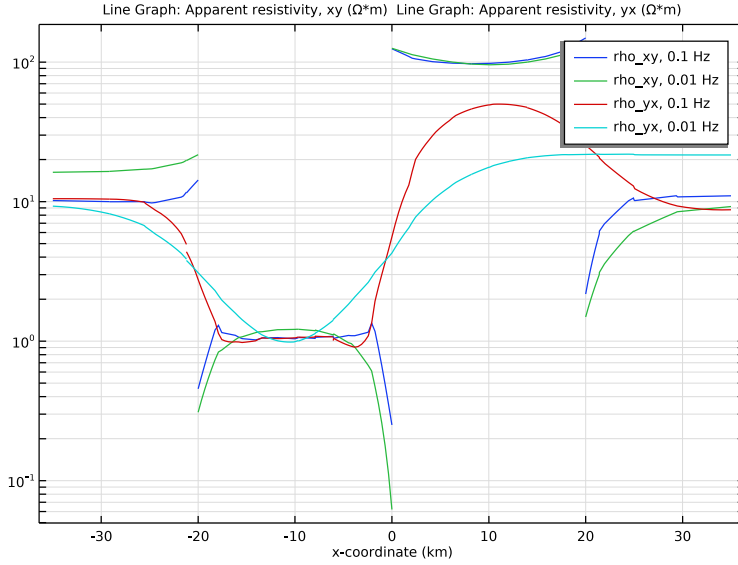

Figure 4: Apparent resistivity across strike (ρ_{xy} and ρ_{yx}), for the two frequencies 0.1 and 0.01 Hz.

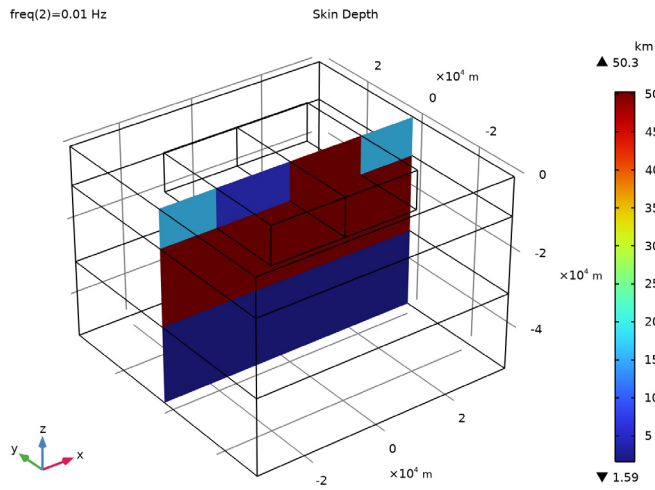

Figure 5: Skin depth (m) at the center of the 3D model for the frequency of 0.01 Hz.

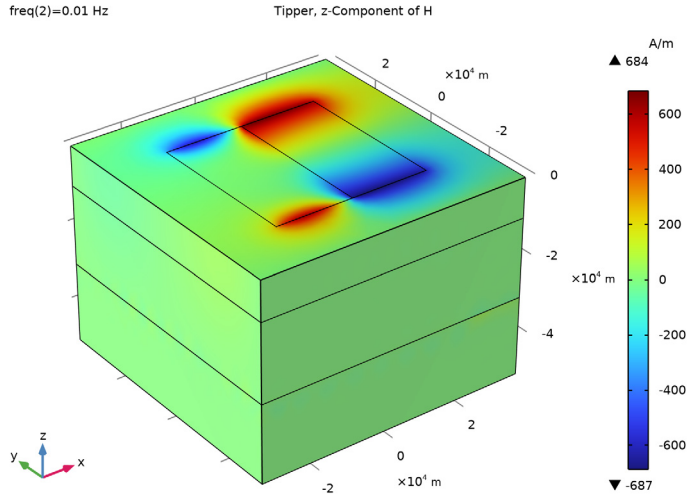

Figure 6: Tipper plot, H_z component of magnetic field (A/m) for the frequency of 0.01 Hz.

It is worth noting that magnetotelluric data analysis is typically done at frequencies ranging from 0.1 mHz to 10 Hz in an evenly spaced logarithmic scale. In this example, only two frequencies are modeled for simplicity. To calculate the response at other frequencies, the model should be adjusted by adapting the model size and the mesh accordingly. This is left as an exercise to the user, but here are a few things to consider. For very high frequencies, the deep part of the model can be ignored. For low frequencies, the lateral dimensions should be larger. Also, evaluate the skin depth to be sure that the model is deep enough for the very low frequencies.

Reference

I. M. Zhdanov, I.M. Varentsov, J.T. Weaver, N.G. Golubev, and V.A. Krylov, “Methods for Modelling Electromagnetic Fields. Results from COMMEMI — The International Project on the Comparison of Modelling Methods for Electromagnetic Induction,” *J. Appl. Geophys.*, vol. 37, pp. 133–271, 1997.



Application Library path: ACDC_Module/Devices,_Resistive/magnetotellurics

From the **File** menu, choose **New**.

NEW

In the **New** window, click  **Model Wizard**.

MODEL WIZARD

- 1 In the **Model Wizard** window, click  **3D**.
- 2 In the **Select Physics** tree, select **AC/DC** > **Electromagnetic Fields** > **Magnetic Fields (mf)**.
- 3 Click **Add**.
- 4 In the **Select Physics** tree, select **AC/DC** > **Electromagnetic Fields** > **Magnetic Fields (mf)**.
- 5 Click **Add**.
- 6 Click  **Study**.
- 7 In the **Select Study** tree, select **General Studies** > **Frequency Domain**.
- 8 Click  **Done**.

GLOBAL DEFINITIONS

Parameters I

The parameters Lx and Ly can be used to control the size of the domain to be studied. For very low frequencies, these parameters may have to take values up to 100 km. For high frequencies, the domain can be much smaller.

- 1 In the **Model Builder** window, under **Global Definitions** click **Parameters I**.
- 2 In the **Settings** window for **Parameters**, locate the **Parameters** section.
- 3 In the table, enter the following settings:



Name	Expression	Value	Description
Lx	70[km]	70000 m	Domain size in x direction
Ly	70[km]	70000 m	Domain size in y direction
Lh	20[km]	20000 m	Height of bottom layers
h_box	10[km]	10000 m	Box height
w_box	20[km]	20000 m	Box width
d_box	40[km]	40000 m	Box depth

GEOMETRY I

Block 1 (blk1)

- 1 In the **Geometry** toolbar, click  **Block**.
- 2 In the **Settings** window for **Block**, locate the **Size and Shape** section.
- 3 In the **Width** text field, type Lx .
- 4 In the **Depth** text field, type Ly .
- 5 In the **Height** text field, type Lh .
- 6 Locate the **Position** section. From the **Base** list, choose **Center**.
- 7 In the **z** text field, type $-2*Lh$.
- 8 Right-click **Block 1 (blk1)** and choose **Build Selected**.

Block 2 (blk2)

- 1 In the **Geometry** toolbar, click  **Block**.
- 2 In the **Settings** window for **Block**, locate the **Size and Shape** section.
- 3 In the **Width** text field, type Lx .
- 4 In the **Depth** text field, type Ly .
- 5 In the **Height** text field, type Lh .
- 6 Locate the **Position** section. From the **Base** list, choose **Center**.
- 7 In the **z** text field, type $-Lh$.
- 8 Right-click **Block 2 (blk2)** and choose **Build Selected**.
- 9 Click the  **Go to Default View** button in the **Graphics** toolbar.

Block 3 (blk3)



- 1 In the **Geometry** toolbar, click  **Block**.
- 2 In the **Settings** window for **Block**, locate the **Size and Shape** section.
- 3 In the **Width** text field, type Lx .
- 4 In the **Depth** text field, type Ly .
- 5 In the **Height** text field, type h_box .
- 6 Locate the **Position** section. From the **Base** list, choose **Center**.
- 7 In the **z** text field, type $-h_box/2$.
- 8 Right-click **Block 3 (blk3)** and choose **Build Selected**.

Block 4 (blk4)

- 1 In the **Geometry** toolbar, click  **Block**.

- 2 In the **Settings** window for **Block**, locate the **Size and Shape** section.
- 3 In the **Width** text field, type `w_box`.
- 4 In the **Depth** text field, type `d_box`.
- 5 In the **Height** text field, type `h_box`.
- 6 Locate the **Position** section. From the **Base** list, choose **Center**.
- 7 In the **x** text field, type `-w_box/2`.
- 8 In the **z** text field, type `-h_box/2`.
- 9 Right-click **Block 4 (blk4)** and choose **Build Selected**.

Block 5 (blk5)

- 1 In the **Geometry** toolbar, click  **Block**.
- 2 In the **Settings** window for **Block**, locate the **Size and Shape** section.
- 3 In the **Width** text field, type `w_box`.
- 4 In the **Depth** text field, type `d_box`.
- 5 In the **Height** text field, type `h_box`.
- 6 Locate the **Position** section. From the **Base** list, choose **Center**.
- 7 In the **x** text field, type `w_box/2`.
- 8 In the **z** text field, type `-h_box/2`.
- 9 Right-click **Block 5 (blk5)** and choose **Build Selected**.
- 10 Click the  **Go to Default View** button in the **Graphics** toolbar.



Form Union (fin)

In the **Model Builder** window, right-click **Form Union (fin)** and choose **Build Selected**.

Import the definition of the components of the resistivity tensor from a text file.

DEFINITIONS

Variables 1

- 1 In the **Definitions** toolbar, click  **Local Variables**.
- 2 In the **Settings** window for **Variables**, locate the **Variables** section.
- 3 Click  **Load from File**.
- 4 Browse to the model's Application Libraries folder and double-click the file `magnetotellurics_variables.txt`.

x Boundaries

- 1 In the **Definitions** toolbar, click  **Explicit**.
- 2 In the **Settings** window for **Explicit**, locate the **Input Entities** section.
- 3 From the **Geometric entity level** list, choose **Boundary**.
- 4 Select Boundaries 1, 4, 7, and 25–27 only.
- 5 In the **Label** text field, type *x Boundaries*.

y Boundaries

- 1 In the **Definitions** toolbar, click  **Explicit**.
- 2 In the **Settings** window for **Explicit**, locate the **Input Entities** section.
- 3 From the **Geometric entity level** list, choose **Boundary**.
- 4 Select Boundaries 2, 5, 8, and 11–13 only.
- 5 In the **Label** text field, type *y Boundaries*.

Top

- 1 In the **Definitions** toolbar, click  **Explicit**.
- 2 In the **Settings** window for **Explicit**, locate the **Input Entities** section.
- 3 From the **Geometric entity level** list, choose **Boundary**.
- 4 Select Boundaries 10, 17, and 22 only.
- 5 In the **Label** text field, type *Top*.

MAGNETIC FIELDS (MF)

Ampère's Law in Solids I

- 1 In the **Physics** toolbar, click  **Domains** and choose **Ampère's Law in Solids**.
- 2 In the **Settings** window for **Ampère's Law in Solids**, locate the **Domain Selection** section.
- 3 From the **Selection** list, choose **All domains**.

The magnetic field source is a plane wave that induces horizontal currents in the whole model. Use a combination of the default Magnetic Insulation boundary condition and the Symmetry Plane boundary condition and to make the domain look like an infinite domain. This assumption should hold well if the domain is large enough around the area of interest with 3D effects. Make L_x and L_y larger if the boundary effects are present. The imposed magnetic field should be parallel to the Magnetic Insulation boundaries and perpendicular to the antisymmetry boundaries.

The magnetotelluric analysis is based on decomposition of the incoming plane waves into two waves with perpendicular polarizations. Solve these two polarizations in two

independent physics interfaces. Then solve the two physics interfaces in a single solver sequence to get all results in a single dataset. The solutions from the two polarizations can thus be obtained for several frequencies.

For the other magnetic field polarization, the boundary conditions should be swapped.

Symmetry Plane 1

- 1 In the **Physics** toolbar, click  **Boundaries** and choose **Symmetry Plane**.
- 2 In the **Model Builder** window, click **Symmetry Plane 1**.
- 3 In the **Settings** window for **Symmetry Plane**, locate the **Boundary Selection** section.
- 4 From the **Selection** list, choose **y Boundaries**.
- 5 Locate the **Symmetry Plane** section. From the **Symmetry type for the magnetic flux density** list, choose **Antisymmetry**.

The magnetic field is a plane wave with arbitrary amplitude and polarization along the x -axis or y -axis. For numerical stability, it makes sense to impose a magnetic field with a large amplitude. Because the magnetotelluric analysis is based on normalization between the various field components, the amplitude is not significant.

Tangential Magnetic Field 1

- 1 In the **Physics** toolbar, click  **Boundaries** and choose **Tangential Magnetic Field**.
- 2 In the **Settings** window for **Tangential Magnetic Field**, locate the **Boundary Selection** section.
- 3 From the **Selection** list, choose **Top**.
- 4 Locate the **Tangential Magnetic Field** section. Specify the \mathbf{H}_0 vector as

0	x
1000	y
0	z

MAGNETIC FIELDS 2 (MF2)

In the **Model Builder** window, under **Component 1 (comp1)** click **Magnetic Fields 2 (mf2)**.

Ampère's Law in Solids 1

- 1 In the **Physics** toolbar, click  **Domains** and choose **Ampère's Law in Solids**.
- 2 In the **Settings** window for **Ampère's Law in Solids**, locate the **Domain Selection** section.
- 3 From the **Selection** list, choose **All domains**.

Symmetry Plane 1

- 1 In the **Physics** toolbar, click  **Boundaries** and choose **Symmetry Plane**.
- 2 In the **Model Builder** window, click **Symmetry Plane 1**.
- 3 In the **Settings** window for **Symmetry Plane**, locate the **Boundary Selection** section.
- 4 From the **Selection** list, choose **x Boundaries**.
- 5 Locate the **Symmetry Plane** section. From the **Symmetry type for the magnetic flux density** list, choose **Antisymmetry**.

Tangential Magnetic Field 1

- 1 In the **Physics** toolbar, click  **Boundaries** and choose **Tangential Magnetic Field**.
- 2 In the **Settings** window for **Tangential Magnetic Field**, locate the **Boundary Selection** section.
- 3 From the **Selection** list, choose **Top**.
- 4 Locate the **Tangential Magnetic Field** section. Specify the \mathbf{H}_0 vector as

1000	x
0	y
0	z

MATERIALS

Now define the four kinds of rocks in this model. The relative permeability and permittivity are set to one. The resistivities, entered as conductivities, are 100, 10, 1 and 0.1 Ωm .

Rock 100ohmm

- 1 In the **Model Builder** window, under **Component 1 (comp1)** right-click **Materials** and choose **Blank Material**.
- 2 Select Domains 2 and 5 only.
- 3 In the **Settings** window for **Material**, locate the **Material Contents** section.

4 In the table, enter the following settings:

Property	Variable	Value	Unit	Property group
Relative permeability	mur_iso ; murii = mur_iso, murij = 0	1		Basic
Electric conductivity	sigma_iso ; sigmair = sigma_iso, sigmairj = 0	0.01	S/m	Basic
Relative permittivity	epsilon_r_iso ; epsilon_r_ii = epsilon_r_iso, epsilon_r_ij = 0	1		Basic

5 In the **Label** text field, type Rock 100ohmm.

Rock 100ohmm

1 Right-click **Materials** and choose **Blank Material**.

2 Select Domain 3 only.

3 In the **Settings** window for **Material**, locate the **Material Contents** section.

4 In the table, enter the following settings:

Property	Variable	Value	Unit	Property group
Relative permeability	mur_iso ; murii = mur_iso, murij = 0	1		Basic
Electric conductivity	sigma_iso ; sigmair = sigma_iso, sigmairj = 0	0.1	S/m	Basic
Relative permittivity	epsilon_r_iso ; epsilon_r_ii = epsilon_r_iso, epsilon_r_ij = 0	1		Basic

5 In the **Label** text field, type Rock 10ohmm.

Rock 10ohmm

1 Right-click **Materials** and choose **Blank Material**.

2 Select Domain 4 only.

3 In the **Settings** window for **Material**, locate the **Material Contents** section.

4 In the table, enter the following settings:

Property	Variable	Value	Unit	Property group
Relative permeability	mur_iso ; murii = mur_iso, murij = 0	1		Basic
Electric conductivity	sigma_iso ; sigmair = sigma_iso, sigmairj = 0	1	S/m	Basic
Relative permittivity	epsilon_r_iso ; epsilon_r_ii = epsilon_r_iso, epsilon_r_ij = 0	1		Basic

5 In the **Label** text field, type Rock 1ohmm.

Rock 0.1ohmm

1 Right-click **Materials** and choose **Blank Material**.

2 Select Domain 1 only.

3 In the **Settings** window for **Material**, locate the **Material Contents** section.

4 In the table, enter the following settings:



Property	Variable	Value	Unit	Property group
Relative permeability	mur_iso ; murii = mur_iso, murij = 0	1		Basic
Electric conductivity	sigma_iso ; sigmair = sigma_iso, sigmairj = 0	10	S/m	Basic
Relative permittivity	epsilon_r_iso ; epsilon_r_ii = epsilon_r_iso, epsilon_r_ij = 0	1		Basic

5 In the **Label** text field, type Rock 0.1ohmm.



Use mapped meshes in order to apply symmetry boundaries.

MESH 1



Free Triangular 1

- 1 In the **Mesh** toolbar, click  **More Generators** and choose **Free Triangular**.
- 2 Select Boundaries 1, 2, 4, 5, 7, and 8 only.
- 3 In the **Settings** window for **Free Triangular**, click  **Build Selected**.

Copy Face 1

- 1 In the **Mesh** toolbar, click  **Copy** and choose **Copy Face**.
- 2 Select Boundaries 1, 4, and 7 only.
- 3 In the **Settings** window for **Copy Face**, locate the **Destination Boundaries** section.
- 4 Click to select the  **Activate Selection** toggle button.
- 5 Select Boundaries 25–27 only.

Copy Face 2

- 1 In the **Mesh** toolbar, click  **Copy** and choose **Copy Face**.
- 2 Select Boundaries 2, 5, and 8 only.
- 3 In the **Settings** window for **Copy Face**, locate the **Destination Boundaries** section.
- 4 Click to select the  **Activate Selection** toggle button.
- 5 Select Boundaries 11–13 only.

The mesh must be adapted to the frequency. For high frequencies, the mesh must be fine, and the deeper parts of the model can be excluded from the active domains.

Free Tetrahedral 1

In the **Mesh** toolbar, click  **Free Tetrahedral**.

Size 1

- 1 Right-click **Free Tetrahedral 1** and choose **Size**.
- 2 In the **Settings** window for **Size**, locate the **Geometric Entity Selection** section.
- 3 From the **Geometric entity level** list, choose **Domain**.
- 4 Select Domains 4 and 5 only.
- 5 Locate the **Element Size** section. From the **Predefined** list, choose **Extra fine**.
- 6 Click  **Build All**.

STUDY 1

Set the frequencies for which to solve; the low frequencies may take a long time to solve, and the mesh and the size of the domain should be adapted to each frequency.

Step 1: Frequency Domain

- 1 In the **Model Builder** window, under **Study 1** click **Step 1: Frequency Domain**.
- 2 In the **Settings** window for **Frequency Domain**, locate the **Study Settings** section.
- 3 In the **Frequencies** text field, type 0.1 0.01.

To obtain separate solutions for the two polarizations, deactivate the second physics interface in the first solver step.

- 4 Locate the **Physics and Variables Selection** section. In the **Solve for** column of the table, under **Component 1 (comp1)**, clear the checkbox for **Magnetic Fields 2 (mf2)**.



Step 2: Frequency Domain 2

- 1 In the **Study** toolbar, click  **Frequency Domain**.
- 2 In the **Settings** window for **Frequency Domain**, locate the **Study Settings** section.
- 3 In the **Frequencies** text field, type 0.1 0.01.

Deactivate the first physics interface in the second solver step.

- 4 Locate the **Physics and Variables Selection** section. In the **Solve for** column of the table, under **Component 1 (comp1)**, clear the checkbox for **Magnetic Fields (mf)**.

Solution 1 (sol1)

- 1 In the **Study** toolbar, click  **Show Default Solver**.
- 2 In the **Model Builder** window, expand the **Solution 1 (sol1)** node, then click **Dependent Variables 2**.
- 3 In the **Settings** window for **Dependent Variables**, locate the **General** section.
- 4 From the **Defined by study step** list, choose **User defined**.
- 5 Locate the **Initial Values of Variables Solved For** section. From the **Method** list, choose **Initial expression**.
- 6 From the **Solution** list, choose **Zero**.
- 7 Locate the **Values of Variables Not Solved For** section. From the **Selection** list, choose **Automatic (all solutions)**.
- 8 In the **Study** toolbar, click  **Compute**.

RESULTS



Cut Plane 1

- 1 In the **Results** toolbar, click  **Cut Plane**.
- 2 In the **Settings** window for **Cut Plane**, locate the **Plane Data** section.
- 3 From the **Plane** list, choose **xy-planes**.

2D Plot Group 3

In the **Results** toolbar, click  **2D Plot Group**.

Surface 1

- 1 Right-click **2D Plot Group 3** and choose **Surface**.
- 2 In the **Settings** window for **Surface**, locate the **Expression** section.
- 3 In the **Expression** text field, type `rho_xy`.
- 4 Locate the **Coloring and Style** section. From the **Scale** list, choose **Logarithmic**.
- 5 In the **2D Plot Group 3** toolbar, click  **Plot**.
- 6 Click the  **Go to Default View** button in the **Graphics** toolbar.

Apparent Resistivity, xy-Plane

- 1 In the **Model Builder** window, click **2D Plot Group 3**.
- 2 In the **Settings** window for **2D Plot Group**, click to expand the **Title** section.
- 3 From the **Title type** list, choose **Label**.
- 4 In the **Label** text field, type `Apparent Resistivity, xy-Plane`.
- 5 Locate the **Color Legend** section. Select the **Show maximum and minimum values** checkbox.
- 6 Select the **Show units** checkbox.

2D Plot Group 4

In the **Results** toolbar, click  **2D Plot Group**.

Surface 1

- 1 Right-click **2D Plot Group 4** and choose **Surface**.
- 2 In the **Settings** window for **Surface**, locate the **Expression** section.
- 3 In the **Expression** text field, type `rho_yx`.
- 4 Locate the **Coloring and Style** section. From the **Scale** list, choose **Logarithmic**.

Apparent Resistivity, yx-Plane

- 1 In the **Model Builder** window, click **2D Plot Group 4**.

- 2 In the **Settings** window for **2D Plot Group**, locate the **Title** section.
- 3 From the **Title type** list, choose **Label**.
- 4 In the **Label** text field, type **Apparent Resistivity, yx-Plane**.
- 5 Locate the **Color Legend** section. Select the **Show maximum and minimum values** checkbox.
- 6 Select the **Show units** checkbox.
- 7 In the **Apparent Resistivity, yx-Plane** toolbar, click  **Plot**.

In this geometrically simple model, the strike is well known and the apparent resistivities can be plotted along a line crossing the strike. In the case of a half-space model, the apparent resistivity is equal to the resistivity of the half-space. The skin depth of the high-frequency waves is very short and the corresponding apparent resistivity will therefore be equal to the resistivity of the shallow features in the subsurface. The low frequencies will penetrate further and will "see" deeper into the Earth. Analysis of the apparent resistivity as a function of frequency is central to magnetotellurics, and subsurface imaging can be done with inversion techniques using data from many frequencies over a large surface area.

Cut Line 3D 1



- 1 In the **Results** toolbar, click  **Cut Line 3D**.
- 2 In the **Settings** window for **Cut Line 3D**, locate the **Line Data** section.
- 3 In row **Point 1**, set **x** to -35000.
- 4 In row **Point 2**, set **x** to 35000.

ID Plot Group 5

- 1 In the **Results** toolbar, click  **ID Plot Group**.
- 2 In the **Settings** window for **ID Plot Group**, locate the **Data** section.
- 3 From the **Dataset** list, choose **Cut Line 3D 1**.

Line Graph 1

- 1 Right-click **ID Plot Group 5** and choose **Line Graph**.
- 2 In the **Settings** window for **Line Graph**, click **Replace Expression** in the upper-right corner of the **y-Axis Data** section. From the menu, choose **Component 1 (comp1) > Definitions > Variables > rho_xy - Apparent resistivity, xy - Ω .m**.
- 3 Locate the **x-Axis Data** section. From the **Parameter** list, choose **Expression**.
- 4 Click **Replace Expression** in the upper-right corner of the **x-Axis Data** section. From the menu, choose **Component 1 (comp1) > Geometry > Coordinate > x - x-coordinate**.
- 5 Locate the **x-Axis Data** section. From the **Unit** list, choose **km**.

- 6 Click to expand the **Legends** section. Select the **Show legends** checkbox.
- 7 From the **Legends** list, choose **Evaluated**.
- 8 In the **Legend** text field, type `rho_xy, eval(freq) Hz`.
- 9 In the **ID Plot Group 5** toolbar, click  **Plot**.
- 10 Click the  **y-Axis Log Scale** button in the **Graphics** toolbar.

Line Graph 2

- 1 Right-click **Line Graph 1** and choose **Duplicate**.
- 2 In the **Settings** window for **Line Graph**, click **Replace Expression** in the upper-right corner of the **y-Axis Data** section. From the menu, choose **Component 1 (comp1) > Definitions > Variables > rho_yx - Apparent resistivity, yx - Ω.m**.
- 3 Locate the **Legends** section. In the **Legend** text field, type `rho_yx, eval(freq) Hz`.
- 4 In the **ID Plot Group 5** toolbar, click  **Plot**.

Apparent Resistivity Across Strike

- 1 In the **Model Builder** window, click **ID Plot Group 5**.
- 2 In the **Settings** window for **ID Plot Group**, click to expand the **Title** section.
- 3 From the **Title type** list, choose **Label**.
- 4 In the **Label** text field, type `Apparent Resistivity Across Strike`.
- 5 Locate the **Plot Settings** section.
- 6 Select the **y-axis label** checkbox. In the associated text field, type `Resistivity ([Omega]*m)`.

Skin Depth

- 1 In the **Results** toolbar, click  **3D Plot Group**.
- 2 In the **Settings** window for **3D Plot Group**, type `Skin Depth` in the **Label** text field.
- 3 Click to expand the **Title** section. From the **Title type** list, choose **Label**.
- 4 Locate the **Color Legend** section. Select the **Show maximum and minimum values** checkbox.
- 5 Select the **Show units** checkbox.

Slice 1

- 1 Right-click **Skin Depth** and choose **Slice**.
- 2 In the **Settings** window for **Slice**, click **Replace Expression** in the upper-right corner of the **Expression** section. From the menu, choose **Component 1 (comp1) > Magnetic Fields > Material properties > mf.deltaS - Skin depth - m**.

- 3 Locate the **Expression** section. From the **Unit** list, choose **km**.
- 4 Locate the **Plane Data** section. From the **Plane** list, choose **zx-planes**.
- 5 In the **Planes** text field, type 1.
- 6 In the **Skin Depth** toolbar, click  **Plot**.

Tipper, z-Component of H

- 1 In the **Results** toolbar, click  **3D Plot Group**.
- 2 In the **Settings** window for **3D Plot Group**, type Tipper, z-Component of H in the **Label** text field.
- 3 Locate the **Title** section. From the **Title type** list, choose **Label**.
- 4 Locate the **Color Legend** section. Select the **Show maximum and minimum values** checkbox.
- 5 Select the **Show units** checkbox.

Surface I

- 1 Right-click **Tipper, z-Component of H** and choose **Surface**.
- 2 In the **Settings** window for **Surface**, click **Replace Expression** in the upper-right corner of the **Expression** section. From the menu, choose **Component I (comp I) > Magnetic Fields > Magnetic > Magnetic field - A/m > mf.Hz - Magnetic field, z-component**.
- 3 In the **Tipper, z-Component of H** toolbar, click  **Plot**.