



Model created in COMSOL Multiphysics 6.4

Inductance Matrix Calculation of PCB Coils

Introduction

PCB (printed-circuit board) coils are widely used in a variety of industrial applications such as micromotor and microelectronic devices. For an array of PCB coils, it is generally of interest to know the inductive coupling represented by the inductance matrix. This model demonstrates how to use the Magnetic Fields, Currents Only interface to compute the inductance matrix of an array of coils in a multilayer PCB, as shown in [Figure 1](#).

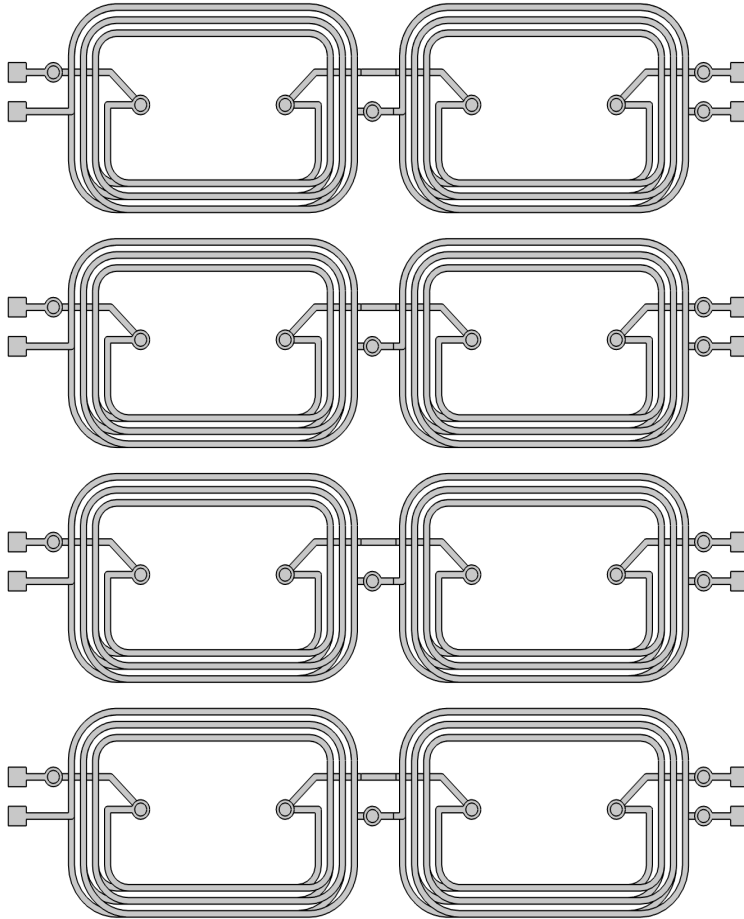

Figure 1: The geometry of PCB coils.

Model Definition

The geometry of the coils is usually ‘open’; the modeling of a closed current loop is not of interest and is also not necessary. The Magnetic Fields, Currents Only interface can model such nondivergence-free currents. For more details, see *Theory for the Magnetic Fields, Currents Only Interface* in the *AC/DC Module User’s Guide*.

The PCB coils are modeled by the **Conductor** feature, which can be used to easily set up the current sources. With using the **Split by Connectivity** functionality, 12 coils can be automatically identified and the corresponding **Conductor** features are created. This greatly simplifies the steps to set up the physics interface. The model is solved with a **Stationary Source Sweep** with **Initialization** study, as well as with a **Frequency Domain Source Sweep** with **Initialization** study. Both of these are dedicated to computing the lumped inductance matrix.

Results and Discussion

Figure 2 shows the distribution of the magnetic flux density norm around the PCB coils when the 8th conductor is activated, in the stationary case. Figure 3 illustrates the corresponding inductance matrix of the PCB coils. Similar plots for the frequency domain solution, are shown in Figure 4 and Figure 5, respectively.

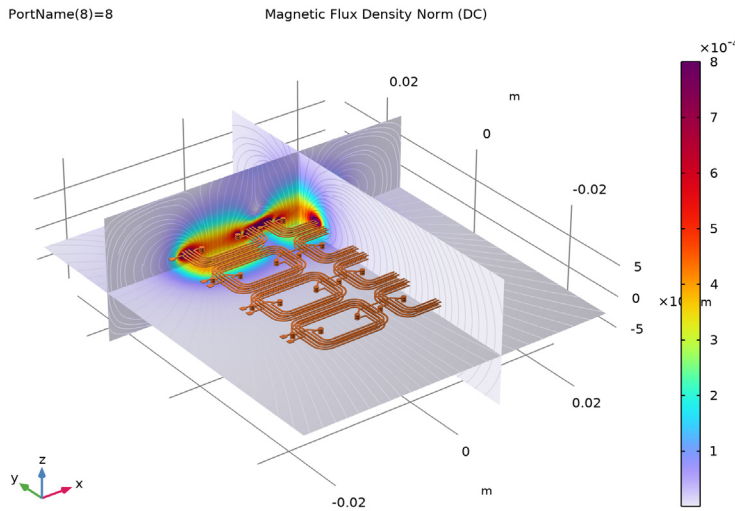

Figure 2: The distribution of the magnetic flux density norm around PCB coils, stationary solution.

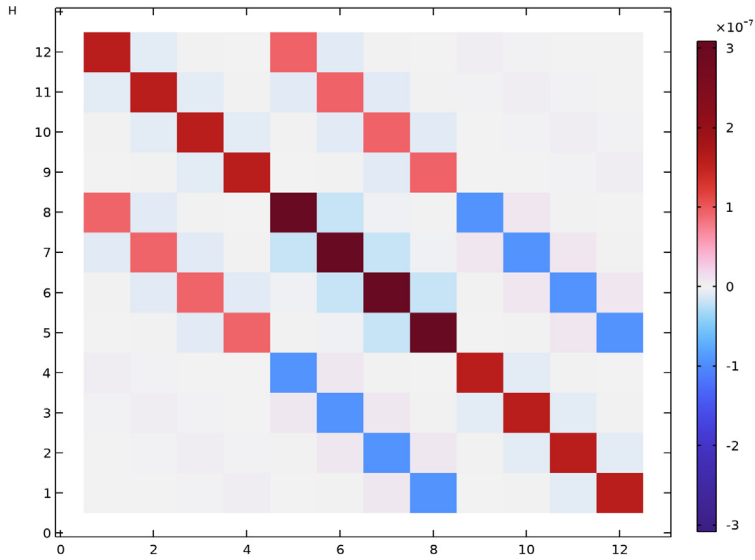

Figure 3: Visualization of the inductance matrix of PCB coils, stationary solution.

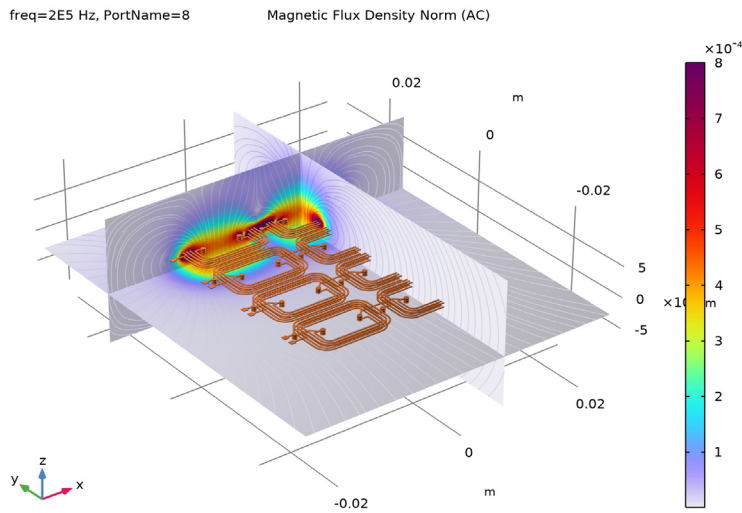

Figure 4: The distribution of the magnetic flux density norm around PCB coils, frequency domain solution.

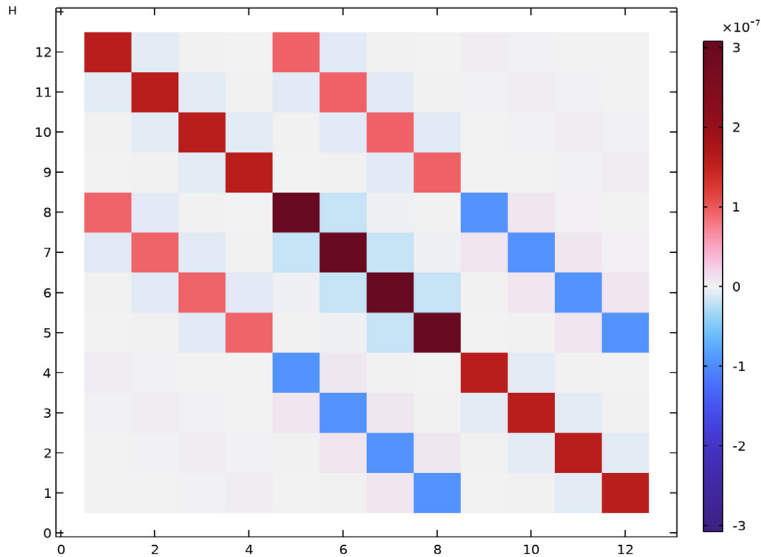



Figure 5: Visualization of the inductance matrix of PCB coils, frequency domain solution.

Application Library path: ACDC_Module/Devices,_Inductive/
inductance_matrix_pcb_coils



Modeling Instructions

From the **File** menu, choose **New**.

NEW

In the **New** window, click  **Model Wizard**.

MODEL WIZARD

- 1 In the **Model Wizard** window, click  **3D**.
- 2 In the **Select Physics** tree, select **AC/DC** > **Electromagnetic Fields** > **Vector Formulations** > **Magnetic Fields, Currents Only (mfco)**.
- 3 Click **Add**.
- 4 Click  **Study**.

5 In the **Select Study** tree, select **Preset Studies for Selected Physics Interfaces > Stationary Source Sweep with Initialization**.

6 Click  **Done**.

GEOMETRY I

1 In the **Model Builder** window, under **Component 1 (comp1)** click **Geometry 1**.

2 In the **Settings** window for **Geometry**, locate the **Advanced** section.

3 From the **Geometry representation** list, choose **CAD kernel**.

Import 1 (imp1)

Since the geometry used for the model is quite complicated, import the coils from an existing file. Then manually add some blocks around these coils in the geometry to simplify the postprocessing.

1 In the **Geometry** toolbar, click  **Import**.

2 In the **Settings** window for **Import**, locate the **Source** section.

3 From the **Source** list, choose **COMSOL Multiphysics file**.

4 In the **Filename** text field, type `inductance_matrix_pcb_coils.mphbin`.

5 Click  **Import**.

6 Click to expand the **Selections of Resulting Entities** section. Select the **Resulting objects selection** checkbox.

7 From the **Show in physics** list, choose **All levels**.

- 8 Click the  **Transparency** button in the **Graphics** toolbar.

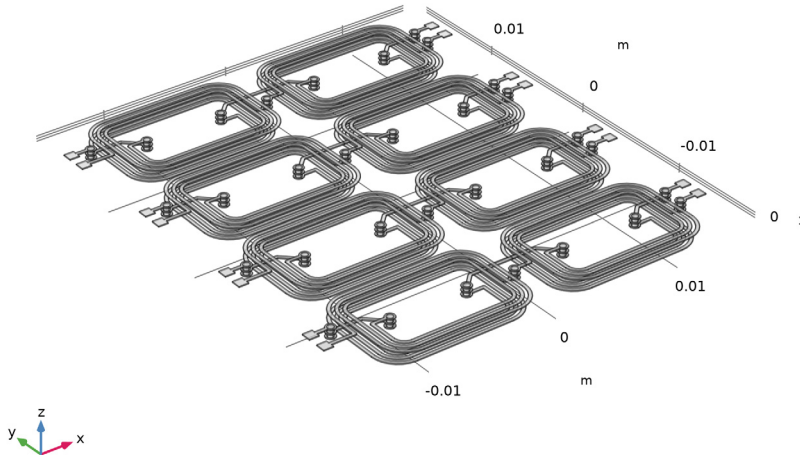

Ground Boundaries

- 1 In the **Geometry** toolbar, click  **Selections** and choose **Explicit Selection**.
- 2 In the **Settings** window for **Explicit Selection**, locate the **Entities to Select** section.
- 3 From the **Geometric entity level** list, choose **Boundary**.
- 4 On the object **impl**, select Boundaries 6, 16, 26, 36, 2502, 2504, 2506, and 2508 only.
- 5 In the **Label** text field, type Ground Boundaries.

Input Terminals

- 1 In the **Geometry** toolbar, click  **Selections** and choose **Explicit Selection**.
- 2 In the **Settings** window for **Explicit Selection**, locate the **Entities to Select** section.
- 3 From the **Geometric entity level** list, choose **Boundary**.
- 4 On the object **impl**, select Boundaries 1, 11, 21, and 31 only.
- 5 In the **Label** text field, type Input Terminals.

Interior Terminals



- 1 In the **Geometry** toolbar, click  **Selections** and choose **Explicit Selection**.
- 2 In the **Settings** window for **Explicit Selection**, locate the **Entities to Select** section.

- 3 From the **Geometric entity level** list, choose **Boundary**.
- 4 On the object **impl**, select Boundaries 1261, 1266, 1271, and 1276 only.
- 5 In the **Label** text field, type Interior Terminals.

Output Terminals

- 1 In the **Geometry** toolbar, click  **Selections** and choose **Explicit Selection**.
- 2 In the **Settings** window for **Explicit Selection**, type Output Terminals in the **Label** text field.
- 3 Locate the **Entities to Select** section. From the **Geometric entity level** list, choose **Boundary**.
- 4 On the object **impl**, select Boundaries 2501, 2503, 2505, and 2507 only.

Union Selection 1 (unisell)

- 1 In the **Geometry** toolbar, click  **Selections** and choose **Union Selection**.
- 2 In the **Settings** window for **Union Selection**, locate the **Geometric Entity Level** section.
- 3 From the **Level** list, choose **Boundary**.
- 4 Locate the **Input Entities** section. Click  **Add**.
- 5 In the **Add** dialog, in the **Selections to add** list, choose **Input Terminals**, **Interior Terminals**, and **Output Terminals**.
- 6 Click **OK**.

Block 1 (blk1)

- 1 In the **Geometry** toolbar, click  **Block**.
- 2 In the **Settings** window for **Block**, locate the **Size and Shape** section.
- 3 In the **Width** text field, type 5[cm].
- 4 In the **Depth** text field, type 6[cm].
- 5 In the **Height** text field, type 2[cm].
- 6 Locate the **Position** section. From the **Base** list, choose **Center**.

Work Plane 1 (wp1)

- 1 In the **Geometry** toolbar, click  **Work Plane**.
- 2 In the **Settings** window for **Work Plane**, locate the **Plane Definition** section.
- 3 In the **z-coordinate** text field, type -2[mm].

Partition Objects 1 (par1)

- 1 In the **Geometry** toolbar, click  **Booleans and Partitions** and choose **Partition Objects**.

- 2 Select the object **blk1** only.
- 3 In the **Settings** window for **Partition Objects**, locate the **Partition Objects** section.
- 4 From the **Partition with** list, choose **Work plane**.

Work Plane 2 (wp2)

- 1 In the **Geometry** toolbar, click  **Work Plane**.
- 2 In the **Settings** window for **Work Plane**, locate the **Plane Definition** section.
- 3 From the **Plane** list, choose **yz-plane**.
- 4 In the **x-coordinate** text field, type 7[mm].

Partition Objects 2 (par2)

- 1 In the **Geometry** toolbar, click  **Booleans and Partitions** and choose **Partition Objects**.
- 2 Select the object **par1** only.
- 3 In the **Settings** window for **Partition Objects**, locate the **Partition Objects** section.
- 4 From the **Partition with** list, choose **Work plane**.

Work Plane 3 (wp3)

- 1 In the **Geometry** toolbar, click  **Work Plane**.
- 2 In the **Settings** window for **Work Plane**, locate the **Plane Definition** section.
- 3 From the **Plane** list, choose **zx-plane**.
- 4 In the **y-coordinate** text field, type 14.25[mm].

Partition Objects 3 (par3)

- 1 In the **Geometry** toolbar, click  **Booleans and Partitions** and choose **Partition Objects**.
- 2 Select the object **par2** only.
- 3 In the **Settings** window for **Partition Objects**, locate the **Partition Objects** section.
- 4 From the **Partition with** list, choose **Work plane**.

Form Union (fin)

- 1 In the **Geometry** toolbar, click  **Build All**.
- 2 Click the  **Go to Default View** button in the **Graphics** toolbar.

3 In the **Model Builder** window, click **Form Union (fin)**.

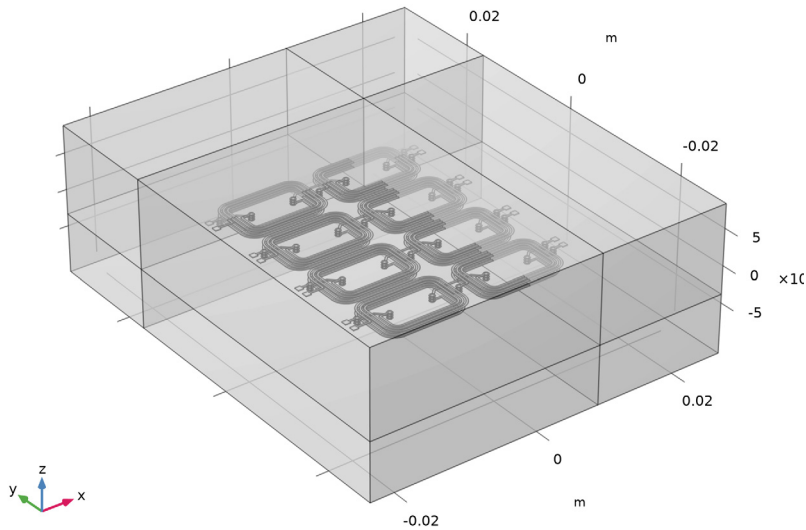

MAGNETIC FIELDS, CURRENTS ONLY (MFCO)

The geometry is now complete. Next, define coil selections for the physics interface to use. This is achieved by selecting all conductors, and then using the **Split by Connectivity** action. This generates a duplicate of the original feature for each connected component. By construction each conductor will be not adjacent to any other **Conductor**, but the selection can be further edited if necessary. Feeding boundary conditions to each **Conductor** will also be similarly set.

Conductor 1

- 1** In the **Physics** toolbar, click  **Domains** and choose **Conductor**.
- 2** In the **Settings** window for **Conductor**, locate the **Domain Selection** section.
- 3** From the **Selection** list, choose **Import 1**.

Ground 1

In the **Physics** toolbar, click  **Attributes** and choose **Ground**.

Terminal 1

- 1** In the **Model Builder** window, click **Terminal 1**.
- 2** In the **Settings** window for **Terminal**, locate the **Boundary Selection** section.

- 3 From the **Selection** list, choose **Union Selection 1**.

Ground 1

- 1 In the **Model Builder** window, click **Ground 1**.
- 2 In the **Settings** window for **Ground**, locate the **Boundary Selection** section.
- 3 From the **Selection** list, choose **Ground Boundaries**.

Conductor 12



In the **Model Builder** window, under **Component 1 (comp1) > Magnetic Fields, Currents Only (mfco)** right-click **Conductor 1** and choose **Split by Connectivity**.

DEFINITIONS

Hide for Physics 1

- 1 In the **Model Builder** window, expand the **Component 1 (comp1) > Definitions** node.
- 2 Right-click **View 1** and choose **Hide for Physics**.
- 3 In the **Settings** window for **Hide for Physics**, locate the **Geometric Entity Selection** section.
- 4 From the **Geometric entity level** list, choose **Boundary**.
- 5 Select Boundaries 4, 5, and 7 only.

MESH 1

- 1 In the **Model Builder** window, under **Component 1 (comp1)** click **Mesh 1**.
- 2 In the **Settings** window for **Mesh**, locate the **Physics-Controlled Mesh** section.
- 3 From the **Element size** list, choose **Coarser**.
- 4 Click the  **Go to Default View** button in the **Graphics** toolbar.
- 5 Click the  **Transparency** button in the **Graphics** toolbar.

6 Click  **Build All**.

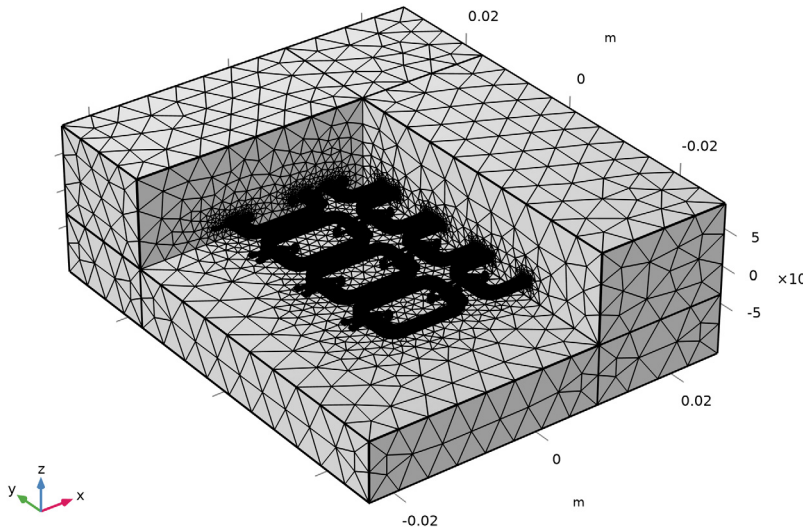

MATERIALS

Material 1 (mat1)

- 1 In the **Model Builder** window, under **Component 1 (comp1)** right-click **Materials** and choose **Blank Material**.
- 2 In the **Settings** window for **Material**, locate the **Geometric Entity Selection** section.
- 3 From the **Selection** list, choose **Import 1**.
- 4 Locate the **Material Contents** section. In the table, enter the following settings:

Property	Variable	Value	Unit	Property group
Electric conductivity	sigma_iso ; sigma_ii = sigma_iso, sigma_ij = 0	6e7	S/m	Basic

STUDY 1

Using **Show Default Solver** it is possible to identify in advance some problems.

Solution 1 (sol1)

In the **Study** toolbar, click  **Show Default Solver**.

MAGNETIC FIELDS, CURRENTS ONLY (MFCO)

Four empty selections **Ground** are identified and they can be inspected and removed before solving.

Ground 1

1 In the **Model Builder** window, under **Component 1 (comp1) > Magnetic Fields, Currents Only (mfco) > Conductor Group 1**, Ctrl-click to select **Conductor 5 > Ground 1, Conductor 6 > Ground 1, Conductor 7 > Ground 1**, and **Conductor 8 > Ground 1**.

2 Right-click and choose **Delete**.

STUDY 1

In the **Study** toolbar, click  **Compute**.

RESULTS

Multislice 1

Now use the blocks around the coil geometry to create an illustration of the magnetic flux density norm. Remember to choose to solution where the coil that intersects the chosen planes is active.

1 In the **Model Builder** window, expand the **Magnetic Flux Density (mfco)** node, then click **Multislice 1**.

2 In the **Settings** window for **Multislice**, locate the **Multiplane Data** section.

3 Find the **x-planes** subsection. In the **Coordinates** text field, type 7[mm].

4 Find the **y-planes** subsection. In the **Coordinates** text field, type 14.25[mm].

5 Find the **z-planes** subsection. In the **Coordinates** text field, type -2[mm].

6 Click to expand the **Range** section. Select the **Manual color range** checkbox.

7 In the **Maximum** text field, type 8.0E-4.

Streamline Multislice 1

1 In the **Model Builder** window, click **Streamline Multislice 1**.

2 In the **Settings** window for **Streamline Multislice**, locate the **Multiplane Data** section.

3 Find the **x-planes** subsection. In the **Coordinates** text field, type 7[mm].

4 Find the **y-planes** subsection. In the **Coordinates** text field, type 14.25[mm].

5 Find the **z-planes** subsection. In the **Coordinates** text field, type -2[mm].

Magnetic Flux Density (mfco)

Right-click **Results** > **Magnetic Flux Density (mfco)** > **Streamline Multislice 1** and choose **Surface**.

Surface 1

- 1 In the **Settings** window for **Surface**, locate the **Expression** section.
- 2 In the **Expression** text field, type 1.

Selection 1

- 1 Right-click **Surface 1** and choose **Selection**.
- 2 In the **Settings** window for **Selection**, locate the **Selection** section.
- 3 From the **Selection** list, choose **Import 1**.

Material Appearance 1

- 1 Right-click **Surface 1** and choose **Material Appearance**.
- 2 In the **Settings** window for **Material Appearance**, locate the **Appearance** section.
- 3 From the **Appearance** list, choose **Custom**.
- 4 From the **Material type** list, choose **Copper**.

Magnetic Flux Density Norm (DC)

- 1 In the **Model Builder** window, under **Results** click **Magnetic Flux Density (mfco)**.
- 2 In the **Settings** window for **3D Plot Group**, type Magnetic Flux Density Norm (DC) in the **Label** text field.
- 3 Locate the **Data** section. From the **Parameter value (PortName)** list, choose **8**.
- 4 Click to expand the **Title** section. From the **Title type** list, choose **Label**.
- 5 Locate the **Plot Settings** section. Clear the **Plot dataset edges** checkbox.
- 6 Locate the **Color Legend** section. Clear the **Show maximum and minimum values** checkbox.

7 In the **Magnetic Flux Density Norm (DC)** toolbar, click  **Plot**.

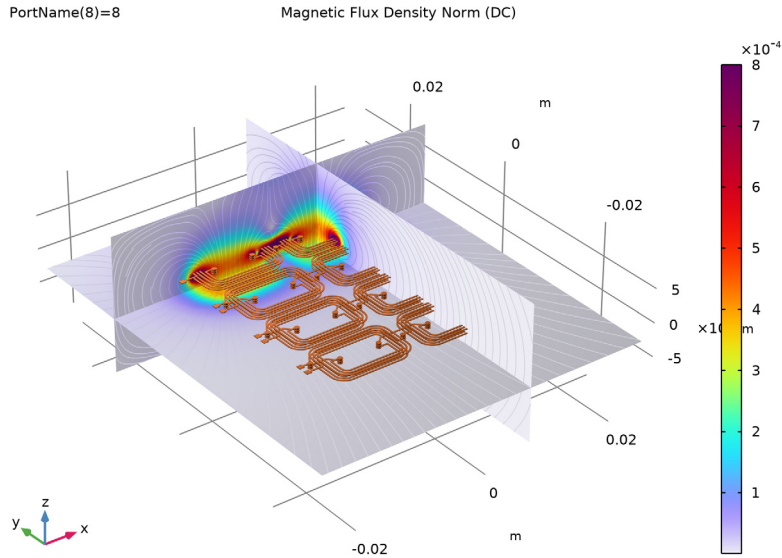

Resistance (DC) (dset1, mfco)

- 1 In the **Model Builder** window, expand the **Results > Lumped Parameters (dset1, mfco)** node, then click **Resistance (DC) (dset1, mfco)**.
- 2 In the **Resistance (DC) (dset1, mfco)** toolbar, click  **Evaluate**.

Inductance (DC) (dset1, mfco)

- 1 In the **Model Builder** window, click **Inductance (DC) (dset1, mfco)**.
- 2 In the **Inductance (DC) (dset1, mfco)** toolbar, click  **Evaluate**.

The inductance matrix is shown in the table, and can be plotted as well.

INDUCTANCE (DC) (DSET1, MFCO)

- 1 Go to the **Inductance (DC) (dset1, mfco)** window.
- 2 Click the **Table Surface** button in the window toolbar.

RESULTS

Table Surface 1

- 1 In the **Settings** window for **Table Surface**, locate the **Data** section.
- 2 From the **Data format** list, choose **Cells**.

- 3 Locate the **Coloring and Style** section. From the **Function** list, choose **Discrete**.
- 4 In the **2D Plot Group 2** toolbar, click  **Plot**.
- 5 From the **Color table** list, choose **Wave**.
- 6 From the **Scale** list, choose **Linear symmetric**.
- 7 Click to expand the **Title** section. From the **Title type** list, choose **None**.

Inductance Matrix (DC)

- 1 In the **Model Builder** window, under **Results** click **2D Plot Group 2**.
- 2 In the **Settings** window for **2D Plot Group**, type Inductance Matrix (DC) in the **Label** text field.
- 3 In the **Inductance Matrix (DC)** toolbar, click  **Plot**.

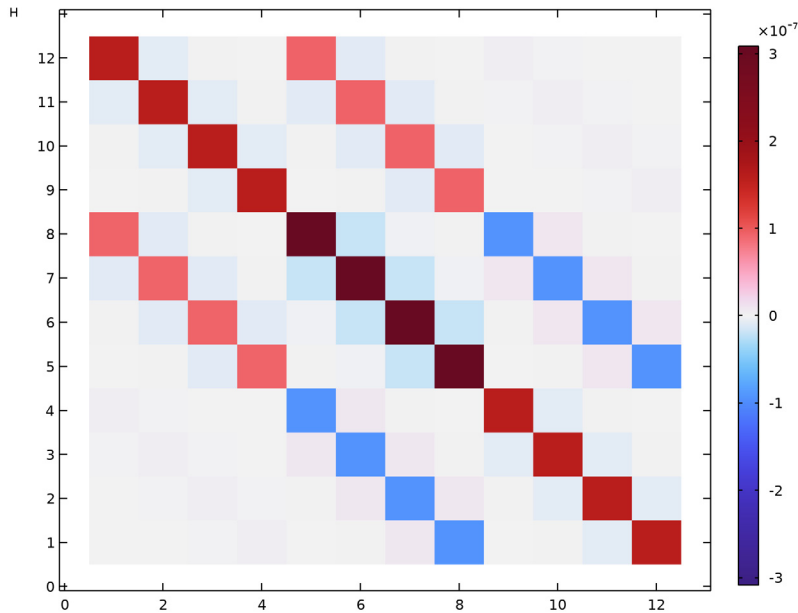

Terminal Number

The splitting of the different conductors can now be illustrated by plotting the terminal numbers.

- 1 In the **Results** toolbar, click  **3D Plot Group**.
- 2 In the **Settings** window for **3D Plot Group**, type Terminal Number in the **Label** text field.



Volume 1

- 1 Right-click **Terminal Number** and choose **Volume**.

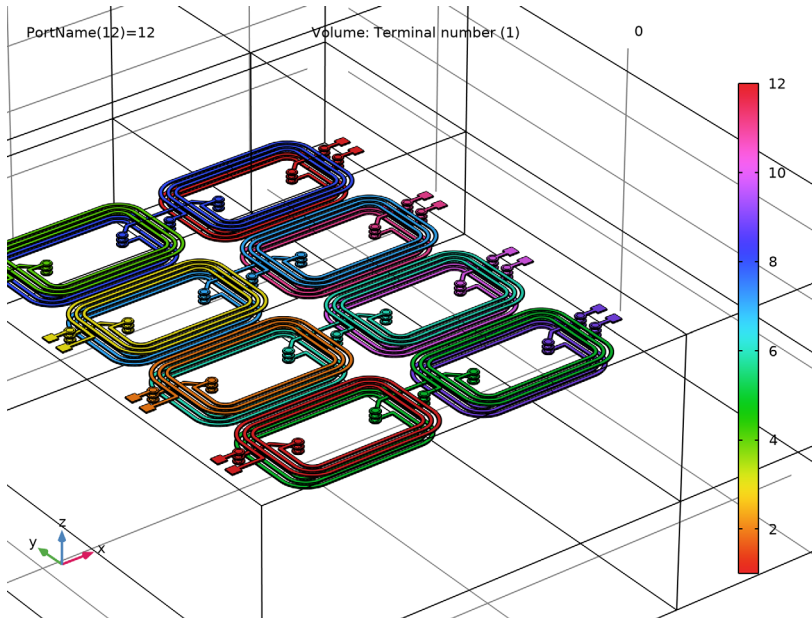
- 2 In the **Settings** window for **Volume**, click **Replace Expression** in the upper-right corner of the **Expression** section. From the menu, choose **Component I (comp1) > Magnetic Fields, Currents Only > Conductors > mfco.TerminalNumber - Terminal number - I**.
- 3 Locate the **Coloring and Style** section. From the **Color table** list, choose **Cyclic**.
- 4 In the **Terminal Number** toolbar, click  **Plot**.



ADD STUDY

- 1 In the **Home** toolbar, click  **Add Study** to open the **Add Study** window.
- 2 Go to the **Add Study** window.
- 3 Find the **Studies** subsection. In the **Select Study** tree, select **Preset Studies for Selected Physics Interfaces > Frequency Domain Source Sweep with Initialization**.
- 4 Click the **Add Study** button in the window toolbar.
- 5 In the **Home** toolbar, click  **Add Study** to close the **Add Study** window.

STUDY 2

Step 2: Frequency Domain Source Sweep

- 1 In the **Settings** window for **Frequency Domain Source Sweep**, locate the **Study Settings** section.

- 2 In the **Frequencies** text field, type 200[kHz].
- 3 In the **Study** toolbar, click **Compute**.

RESULTS

Magnetic Flux Density (mfco)

Right-click **Results** > **Magnetic Flux Density (mfco)** and choose **Delete**.

Magnetic Flux Density Norm (AC)

- 1 In the **Model Builder** window, right-click **Magnetic Flux Density Norm (DC)** and choose **Duplicate**.
- 2 In the **Settings** window for **3D Plot Group**, type Magnetic Flux Density Norm (AC) in the **Label** text field.
- 3 Locate the **Data** section. From the **Dataset** list, choose **Study 2/Solution 3 (sol3)**.
- 4 From the **Parameter value (PortName)** list, choose **8**.
- 5 In the **Magnetic Flux Density Norm (AC)** toolbar, click **Plot**.

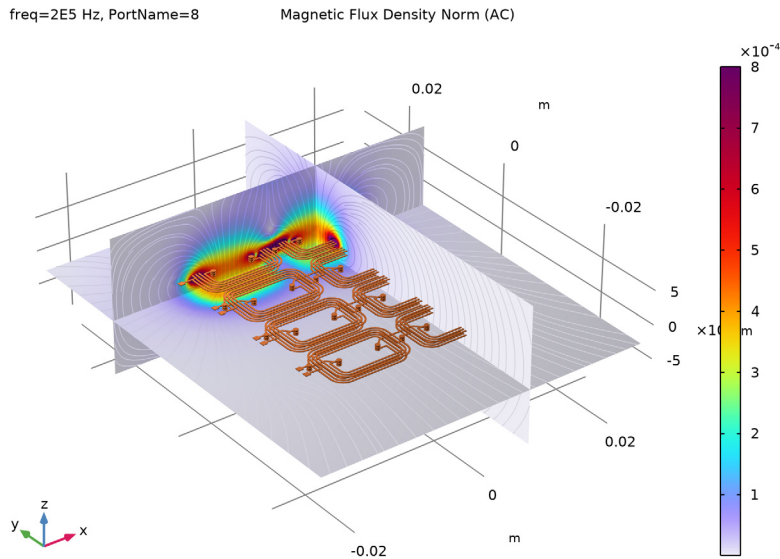

Resistance (DC) (dset3, mfco)

- 1 In the **Model Builder** window, expand the **Results** > **Lumped Parameters (dset3, mfco)** node, then click **Resistance (DC) (dset3, mfco)**.

- 2 In the **Resistance (DC) (dset3, mfco)** toolbar, click **Evaluate**.

Resistance (AC) (dset3, mfco)

- 1 In the **Model Builder** window, click **Resistance (AC) (dset3, mfco)**.
- 2 In the **Resistance (AC) (dset3, mfco)** toolbar, click **Evaluate**.

Inductance (AC) (dset3, mfco)

- 1 In the **Model Builder** window, expand the **Inductance (AC) (dset3, mfco)** node, then click **Inductance (AC) (dset3, mfco)**.
- 2 In the **Settings** window for **Global Matrix Evaluation**, locate the **Data Series Operation** section.
- 3 From the **Parameter (freq)** list, choose **Sum**.
- 4 In the **Inductance (AC) (dset3, mfco)** toolbar, click **Evaluate**.

Impedance (dset3, mfco)

- 1 In the **Model Builder** window, under **Results > Lumped Parameters (dset3, mfco)** click **Impedance (dset3, mfco)**.
- 2 In the **Impedance (dset3, mfco)** toolbar, click **Evaluate**.

Inductance Matrix (AC)

- 1 In the **Model Builder** window, right-click **Inductance Matrix (DC)** and choose **Duplicate**.
- 2 In the **Settings** window for **2D Plot Group**, type Inductance Matrix (AC) in the **Label** text field.

Table Surface 1

- 1 In the **Model Builder** window, expand the **Inductance Matrix (AC)** node, then click **Table Surface 1**.
- 2 In the **Settings** window for **Table Surface**, locate the **Data** section.
- 3 From the **Evaluation group** list, choose **Inductance (AC) (dset3, mfco)**.
- 4 From the **Data format** list, choose **Cells**.

5 In the **Inductance Matrix (AC)** toolbar, click  **Plot**.

