



Model created in COMSOL Multiphysics 6.4

An Electrodynamic Levitation Device

Introduction

This verification application is based on the TEAM benchmark problem 28, “An Electrodynamic Levitation Device” (Ref. 1). The device consists of a circular aluminum plate placed above two cylindrical, concentric coils carrying sinusoidal currents in opposite directions. The time-varying magnetic field created by the coils induces eddy currents in the plate, which, in turn, give rise to a repulsive force sufficient to make the plate levitate at a certain height above the coil.

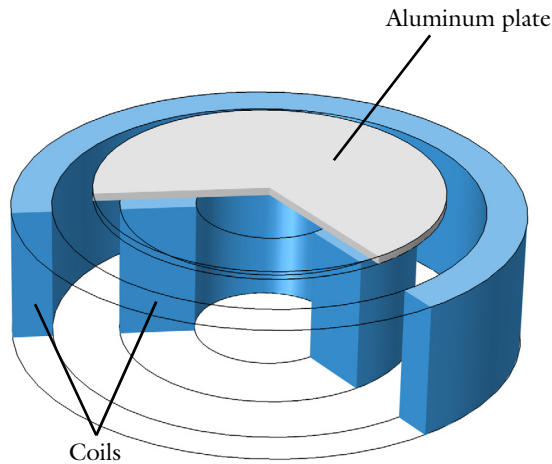

The application models the dynamics of the plate in the time domain, from when the coils are energized to the end of the transient after 1.7 s. The results, and, in particular, the position of the plate, are compared with the experimental data available from the TEAM problem specification.

Model Definition

Due to the rotational symmetry of the system, a two-dimensional axisymmetric geometry is used. The magnetic problem, including the eddy currents, is solved using the **Magnetic Fields** interface, while the rigid body dynamic of the plate is solved as a system of ordinary differential equations (ODE) implemented using the **Global ODEs and DAEs** interface. Finally, the movement of the plate is modeled using **Moving Mesh** features.

THE MAGNETIC PROBLEM

The Magnetic Fields interface is used to compute the magnetic fields and eddy currents. The **Coil** feature with the **Homogenized multiturn** model is used for the current carrying wire bundles. This feature applies a homogenized uniform current density in the azimuthal direction.

The force acting on the plate is computed by using a **Force Calculation** feature, which integrates Maxwell's stress tensor on the boundaries of the plate.

THE PLATE DYNAMICS

The plate moves as a rigid body subject to two forces: gravity and the electromagnetic force acting on the induced eddy currents. Due to symmetry, the plate only moves axially; the z -component of the plate displacement is governed by the ODE:

$$\ddot{u} = \frac{F_{em} - F_g}{m_p} \quad (1)$$

where F_{em} is the electromagnetic force, F_g is the gravity, and m_p is the mass of the plate. This ODE is solved using a **Global ODEs and DAEs** interface. It is reformulated as a system of first-order ODEs, which usually benefit from improved performance and stability:

$$\begin{aligned} \dot{v} &= \frac{F_{em} - F_g}{m_p} \\ \dot{u} &= v \end{aligned} \quad (2)$$

THE MOVING MESH FEATURES

The Moving Mesh features can be used in models where all or part of the geometry is moving with respect to the “laboratory” reference frame. In COMSOL Multiphysics, this reference frame is called the *Spatial* frame and its coordinates are, by default, lowercase letters (x, y, z or r, ϕ, z in axial symmetry). The frame at rest with the materials is called the *Material* frame and, by default, has uppercase coordinates (X, Y, Z or R, Φ, Z in axial symmetry).

The Moving Mesh features deform the mesh in the spatial frame as defined by the frame transformation:

$$\begin{aligned} x &= f(X, Y, Z, \dots) \\ y &= g(X, Y, Z, \dots) \\ z &= h(X, Y, Z, \dots) \end{aligned} \quad (3)$$

The variables x, y , and z are the coordinates of a point of the mesh in the spatial frame. The functions f, g , and h are arbitrary, although they usually are functions of the coordinates of the point in the material frame (X, Y, Z) .

The functions f, g , and h can be explicitly defined by the user by means of the **Prescribed Deformation** feature. It is important to ensure that the functions are continuous everywhere and that they do not give rise to inverted mesh elements.

In this application, to improve the solution performance, the functions are explicitly given. In axisymmetry, the plate is represented as a rectangle touching the axis, surrounded by a void region:

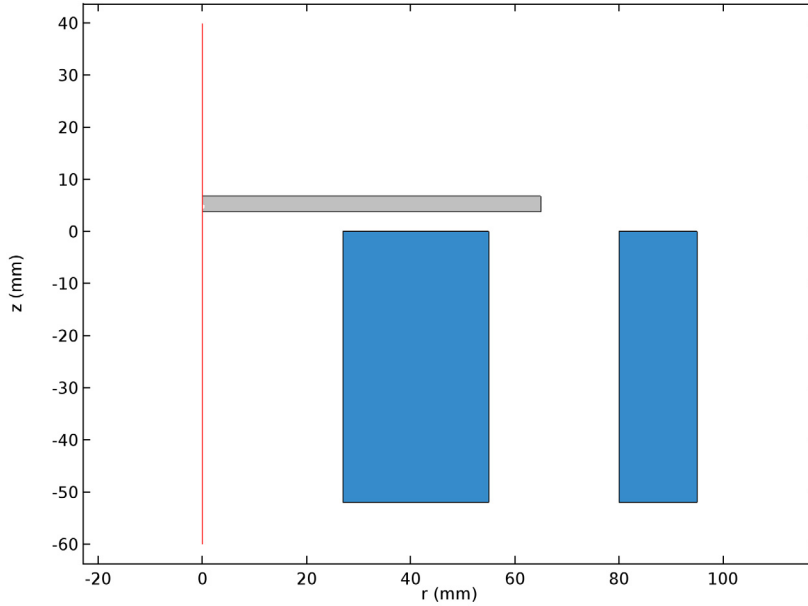

Figure 1: Axisymmetric representation of the system.

The in-plane coordinates in the axisymmetric geometry are r, z (spatial frame) and R, Z (material frame). The frame transformation functions used are:

$$\begin{aligned} r &= R \\ z &= h(R, Z, u) \end{aligned} \quad (4)$$

where u is the instantaneous plate displacement, and h is chosen so that it varies continuously from zero at the exterior boundaries of the free space region and to u in the plate. Due to the symmetry, h can be written as:

$$h(R, Z, u) = u \cdot s_1(R) \cdot s_2(Z) \quad (5)$$

where s_1 and s_2 are maps (parameterization) of the geometry, defined using **Variable** features. The product s_1s_2 is plotted in [Figure 2](#).

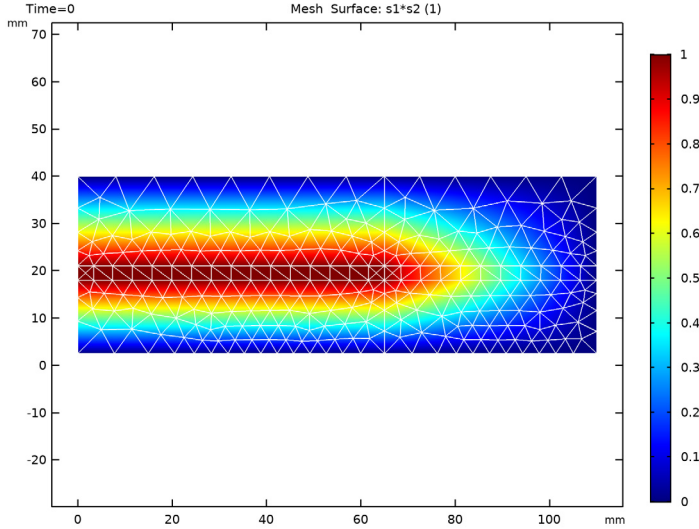

Figure 2: Parameterization of the deformed domain. The parameterization is used to rigidly move the plate and deform continuously the mesh in the surrounding free space domain.

SOLVING IN THE TIME DOMAIN

The system evolves with two time scales: the AC feed has a frequency of 50 Hz, while the plate dynamic is in the order of the tenth of a second. The time steps specified in the **Time Domain** study step determine the stored time instants available for postprocessing. A smaller time step means that more time instants will be available for plotting, at the cost of increased memory usage.

The size of the specified time steps does not affect the solution, only the postprocessing: the solver automatically chooses an appropriate step size to resolve the fastest of the two time scales. The step size chosen in this application is small enough to resolve the plate dynamic, but not the AC frequency. To accurately postprocess the plate displacement, a Probe is used, that records the value of a specified variable at all the time steps taken by the solver.

Results and Discussion

The application uses the **Results While Solving** functionality to visualize the deformation of the mesh during the solution process. Figure 3 shows the mesh and the deformation at $t = 0.16$ s when the plate is at the lowest point of the first oscillation. The mesh is deformed according to the function defined in the Prescribed Deformation feature to accommodate the displacement of the plate.

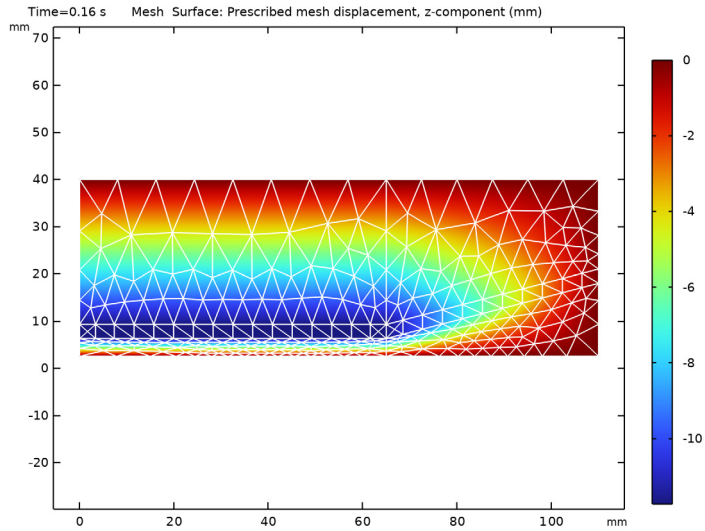

Figure 3: Mesh plot (wireframe) and vertical deformation (color) at $t = 0.16$ s.

Figure 4 shows the magnetic flux density norm and force lines at $t = 0.01$ s.

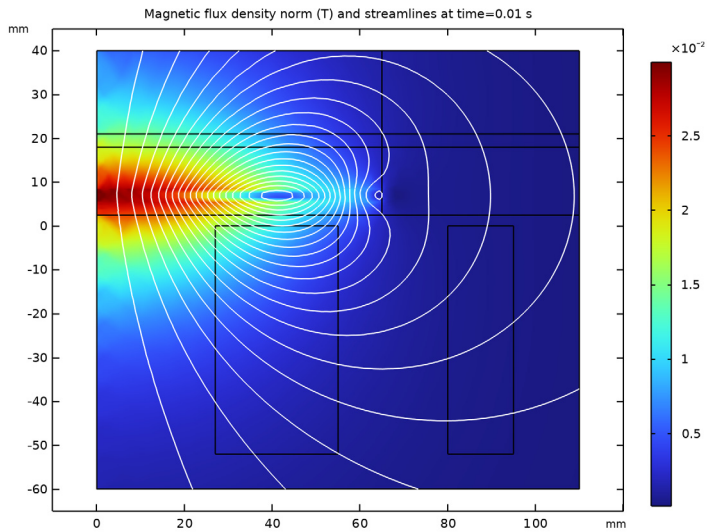

Figure 4: Magnetic flux density norm and field lines at $t = 0.01$ s.

Figure 5 shows a comparison between the computed plate dynamic (the axial displacement) and the experimental data provided in Ref. 1. The dynamics is generally well-resolved, the discrepancy being accountable to the assumptions taken in modeling the

coils as uniform bundles of wires with sharp rectangular cross sections, as detailed in the original reference.

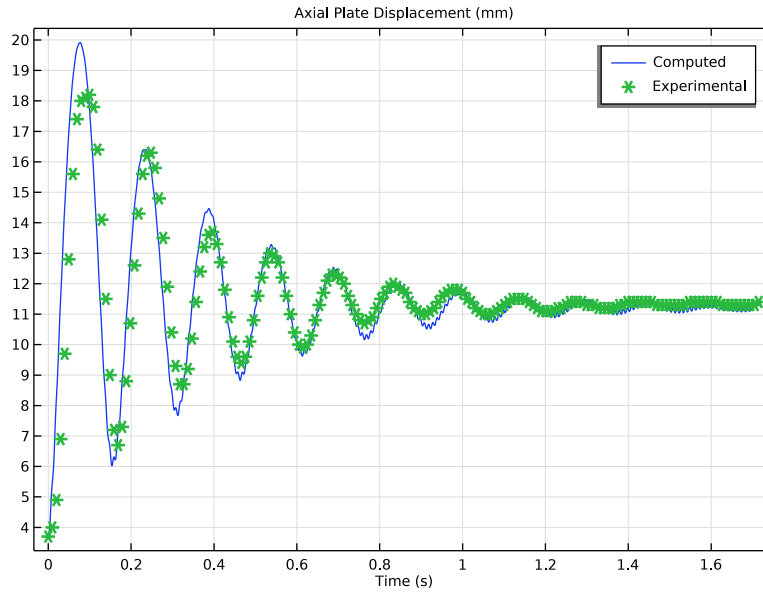

Figure 5: Computed vertical plate displacement as a function of time (blue line), compared with experimental results (green markers).

Reference

1. <http://www.compumag.org/jsite/team.html>
-

Application Library path: ACDC_Module/Verifications/
electrodynamic_levitation_device



Modeling Instructions

From the **File** menu, choose **New**.

NEW

In the **New** window, click  **Model Wizard**.

MODEL WIZARD

- 1 In the **Model Wizard** window, click  **2D Axisymmetric**.
- 2 In the **Select Physics** tree, select **AC/DC** > **Electromagnetic Fields** > **Magnetic Fields (mf)**.
- 3 Click **Add**.
- 4 In the **Select Physics** tree, select **Mathematics** > **ODE and DAE Interfaces** > **Global ODEs and DAEs (ge)**.
- 5 Click **Add**.
- 6 Click  **Study**.
- 7 In the **Select Study** tree, select **General Studies** > **Time Dependent**.
- 8 Click  **Done**.

GLOBAL DEFINITIONS

Import the model parameters from a text file.

Parameters 1

- 1 In the **Model Builder** window, under **Global Definitions** click **Parameters 1**.
- 2 In the **Settings** window for **Parameters**, locate the **Parameters** section.
- 3 Click  **Load from File**.
- 4 Browse to the model's Application Libraries folder and double-click the file `electrodynmic_levitation_device_parameters.txt`.

GEOMETRY 1

Create the 2D axisymmetric geometry.

- 1 In the **Model Builder** window, under **Component 1 (comp1)** click **Geometry 1**.
- 2 In the **Settings** window for **Geometry**, locate the **Units** section.
- 3 From the **Length unit** list, choose **mm**.

Coil 1

- 1 In the **Geometry** toolbar, click  **Rectangle**.
- 2 In the **Settings** window for **Rectangle**, type `Coil 1` in the **Label** text field.
- 3 Locate the **Size and Shape** section. In the **Width** text field, type `28`.
- 4 In the **Height** text field, type `52`.
- 5 Locate the **Position** section. From the **Base** list, choose **Center**.
- 6 In the **r** text field, type `41`.
- 7 In the **z** text field, type `-26`.

Coil 2

- 1 In the **Geometry** toolbar, click  **Rectangle**.
- 2 In the **Settings** window for **Rectangle**, type Coil 2 in the **Label** text field.
- 3 Locate the **Size and Shape** section. In the **Width** text field, type 15.
- 4 In the **Height** text field, type 52.
- 5 Locate the **Position** section. From the **Base** list, choose **Center**.
- 6 In the **r** text field, type 87.5.
- 7 In the **z** text field, type -26.

Add a layered rectangle for the plate and the air domains. The layered structure will make it easier to define the mesh deformation.

Rectangle 3 (r3)

- 1 In the **Geometry** toolbar, click  **Rectangle**.
- 2 In the **Settings** window for **Rectangle**, locate the **Size and Shape** section.
- 3 In the **Width** text field, type 120.
- 4 In the **Height** text field, type $50 - 2 \cdot 5$.
- 5 Locate the **Position** section. In the **z** text field, type 2.5.
- 6 Click to expand the **Layers** section. In the table, enter the following settings:

Layer name	Thickness (mm)
Layer 1	$(39 - 3) / 2 - 2.5$
Layer 2	3
Layer 3	$40 - (39 + 3) / 2$

- 7 Click  **Build Selected**.

Rectangle 4 (r4)

- 1 In the **Geometry** toolbar, click  **Rectangle**.
- 2 In the **Settings** window for **Rectangle**, locate the **Size and Shape** section.
- 3 In the **Width** text field, type 120.
- 4 In the **Height** text field, type $50 - 2 \cdot 5$.
- 5 Locate the **Position** section. In the **z** text field, type 2.5.

6 Locate the **Layers** section. In the table, enter the following settings:

Layer name	Thickness (mm)
Layer 1	65
Layer 2	45

7 Clear the **Layers on bottom** checkbox.

8 Select the **Layers to the left** checkbox.

9 Click  **Build Selected**.

Rectangle 5 (r5)

1 In the **Geometry** toolbar, click  **Rectangle**.

2 In the **Settings** window for **Rectangle**, locate the **Size and Shape** section.

3 In the **Width** text field, type 120.

4 In the **Height** text field, type 72.5.

5 Locate the **Position** section. In the **z** text field, type -70.

6 Locate the **Layers** section. In the table, enter the following settings:

Layer name	Thickness (mm)
Layer 1	10

7 Select the **Layers to the right** checkbox.

8 Click  **Build Selected**.

- 9 Click the  **Zoom Extents** button in the **Graphics** toolbar.

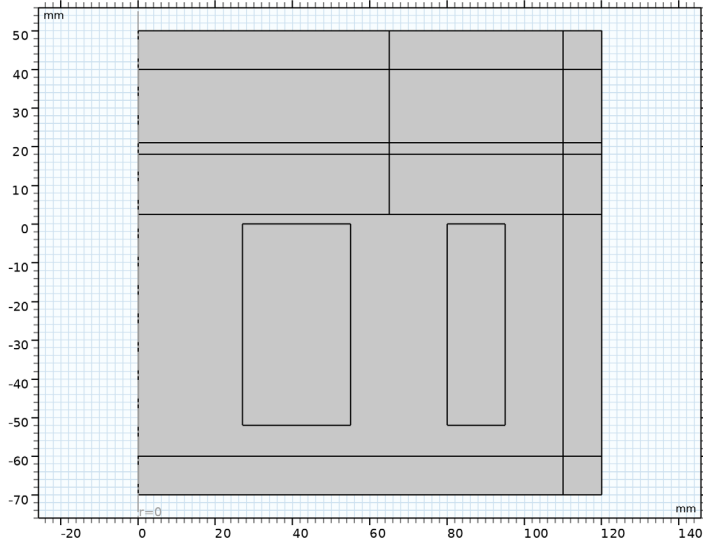

The geometry is now complete.

DEFINITIONS

Create an explicit selection for the infinite element domain.

Infinite Element Domain

- 1 In the **Definitions** toolbar, click  **Explicit**.
- 2 In the **Settings** window for **Explicit**, type Infinite Element Domain in the **Label** text field.
- 3 Select Domains 1, 6, 11, and 13–18 only.

Infinite Element Domain 1 (ie1)

- 1 In the **Definitions** toolbar, click  **Infinite Element Domain**.
- 2 In the **Settings** window for **Infinite Element Domain**, locate the **Domain Selection** section.
- 3 From the **Selection** list, choose **Infinite Element Domain**.
- 4 Locate the **Geometry** section. From the **Type** list, choose **Cylindrical**.

MAGNETIC FIELDS (MF)

Set up the physics to use Ampère's Law in Solids for the plate.

Ampère's Law in Solids 1

- 1 In the **Physics** toolbar, click  **Domains** and choose **Ampère's Law in Solids**.
- 2 Select Domain 4 only.

Create the two **Coil** features.

Domain Coil 1

- 1 In the **Physics** toolbar, click  **Domains** and choose **Domain Coil**.
- 2 Select Domain 7 only.
- 3 In the **Settings** window for **Domain Coil**, locate the **Material Type** section.
- 4 From the **Material type** list, choose **Solid**.
- 5 Locate the **Coil** section. From the **Conductor model** list, choose **Homogenized multiturn**.
- 6 In the I_{coil} text field, type $I_0 \sin(2\pi f_0 t)$.
- 7 Locate the **Homogenized Conductor** section. In the N text field, type N_i .
- 8 From the **Coil wire cross-section area** list, choose **From diameter**.
- 9 In the d text field, type d_{wire} .

Domain Coil 2

- 1 In the **Physics** toolbar, click  **Domains** and choose **Domain Coil**.
- 2 Select Domain 12 only.
- 3 In the **Settings** window for **Domain Coil**, locate the **Material Type** section.
- 4 From the **Material type** list, choose **Solid**.
- 5 Locate the **Coil** section. From the **Conductor model** list, choose **Homogenized multiturn**.
- 6 In the I_{coil} text field, type $-I_0 \sin(2\pi f_0 t)$.
- 7 Locate the **Homogenized Conductor** section. In the N text field, type N_o .
- 8 From the **Coil wire cross-section area** list, choose **From diameter**.
- 9 In the d text field, type d_{wire} .



Force Calculation 1

- 1 In the **Physics** toolbar, click  **Domains** and choose **Force Calculation**.
- 2 In the **Settings** window for **Force Calculation**, locate the **Force Calculation** section.
- 3 In the **Force name** text field, type 0.
- 4 Select Domain 4 only.

MATERIALS

Define the materials to be used in the model.

ADD MATERIAL

- 1 In the **Materials** toolbar, click  **Add Material** to open the **Add Material** window.
- 2 Go to the **Add Material** window.
- 3 In the tree, select **Built-in > Copper**.
- 4 Click the **Add to Component** button in the window toolbar.
- 5 In the **Materials** toolbar, click  **Add Material** to close the **Add Material** window.

MATERIALS

Copper (mat1)

Select Domains 7 and 12 only.

Aluminum

- 1 In the **Model Builder** window, right-click **Materials** and choose **Blank Material**.
- 2 In the **Settings** window for **Material**, type Aluminum in the **Label** text field.
- 3 Select Domain 4 only.
- 4 Locate the **Material Contents** section. In the table, enter the following settings:

Property	Variable	Value	Unit	Property group
Relative permeability	$\text{mur_iso}; \text{murii} = \text{mur_iso}, \text{muri} = 0$	1		Basic
Electric conductivity	$\text{sigma_iso}; \text{sigmaii} = \text{sigma_iso}, \text{sigmaij} = 0$	sigma	S/m	Basic
Relative permittivity	$\text{epsilononr_iso}; \text{epsilononrii} = \text{epsilononr_iso}, \text{epsilononrij} = 0$	1		Basic

DEFINITIONS

Add variables to use in the definition of the plate dynamics.

Variables 1

- 1 In the **Model Builder** window, under **Component 1 (comp1)** right-click **Definitions** and choose **Variables**.
- 2 In the **Settings** window for **Variables**, locate the **Variables** section.

3 In the table, enter the following settings:



Name	Expression	Unit	Description
F_g	M_disc*g_const	N	Gravitational force

PLATE DYNAMICS

Specify the plate dynamics as a pair of ordinary differential equations. To obtain a better performance and stability during the solution process it is usually a good idea to specify first-order ODEs only. To do so, add an additional degree of freedom for the plate velocity.

- 1 In the **Model Builder** window, under **Component 1 (comp1)** click **Global ODEs and DAEs (ge)**.
- 2 In the **Settings** window for **Global ODEs and DAEs**, type Plate Dynamics in the **Label** text field.



Global Equations 1 (ODE1)

- 1 In the **Model Builder** window, under **Component 1 (comp1) > Plate Dynamics (ge)** click **Global Equations 1 (ODE1)**.
- 2 In the **Settings** window for **Global Equations**, locate the **Units** section.
- 3 Click  **Select Dependent Variable Quantity**.
- 4 In the **Physical Quantity** dialog, type velocity in the text field.
- 5 In the tree, select **General > Velocity (m/s)**.
- 6 Click **OK**.
- 7 In the **Settings** window for **Global Equations**, locate the **Units** section.
- 8 Click  **Select Source Term Quantity**.
- 9 In the **Physical Quantity** dialog, type acceleration in the text field.
- 10 In the tree, select **General > Acceleration (m/s^2)**.
- 11 Click **OK**.
- 12 In the **Settings** window for **Global Equations**, locate the **Global Equations** section.
- 13 In the table, enter the following settings:

Name	$f(u,ut,utt,t)$ (m/s^2)	Description
v	$d(v,t)+(F_g-mf.Forcez_0)/M_disc$	Plate velocity

Global Equations 2 (ODE2)

- 1 In the **Global ODEs and DAEs** toolbar, click  **Global Equations**.
- 2 In the **Settings** window for **Global Equations**, locate the **Units** section.

- 3 Click  **Select Dependent Variable Quantity**.
- 4 In the **Physical Quantity** dialog, type displacement in the text field.
- 5 In the tree, select **General > Displacement (m)**.
- 6 Click **OK**.
- 7 In the **Settings** window for **Global Equations**, locate the **Units** section.
- 8 Click  **Select Source Term Quantity**.
- 9 In the **Physical Quantity** dialog, type velocity in the text field.
- 10 In the tree, select **General > Velocity (m/s)**.
- 11 Click **OK**.
- 12 In the **Settings** window for **Global Equations**, locate the **Global Equations** section.
- 13 In the table, enter the following settings:

Name	f(u,ut,utt,t) (m/s)	Initial value (u_0) (m)	Description
u	ut-v	z0	Plate position

DEFINITIONS

Now define the mesh deformation consistently with the movement of the plate. Start by parameterizing the deformed regions with dedicated variables.

z-Parameterization, Top

- 1 In the **Model Builder** window, under **Component 1 (comp1)** right-click **Definitions** and choose **Variables**.
- 2 In the **Settings** window for **Variables**, type z-Parameterization, Top in the **Label** text field.
- 3 Locate the **Geometric Entity Selection** section. From the **Geometric entity level** list, choose **Domain**.
- 4 Select Domains 5 and 10 only.
- 5 Locate the **Variables** section. In the table, enter the following settings:

Name	Expression	Unit	Description
s2	$(40[\text{mm}] - z) / (40[\text{mm}] - 21[\text{mm}])$		

z-Parameterization, Center

- 1 In the **Model Builder** window, right-click **Definitions** and choose **Variables**.
- 2 In the **Settings** window for **Variables**, type z-Parameterization, Center in the **Label** text field.

- 3 Locate the **Geometric Entity Selection** section. From the **Geometric entity level** list, choose **Domain**.
- 4 Select Domains 4 and 9 only.
- 5 Locate the **Variables** section. In the table, enter the following settings:

Name	Expression	Unit	Description
s2	1		

z-Parameterization, Bottom

- 1 Right-click **Definitions** and choose **Variables**.
- 2 In the **Settings** window for **Variables**, type *z-Parameterization, Bottom* in the **Label** text field.
- 3 Locate the **Geometric Entity Selection** section. From the **Geometric entity level** list, choose **Domain**.
- 4 Select Domains 3 and 8 only.
- 5 Locate the **Variables** section. In the table, enter the following settings:

Name	Expression	Unit	Description
s2	$(Z - 2.5[\text{mm}]) / (18[\text{mm}] - 2.5[\text{mm}])$		

r-Parameterization, Left

- 1 Right-click **Definitions** and choose **Variables**.
- 2 In the **Settings** window for **Variables**, type *r-Parameterization, Left* in the **Label** text field.
- 3 Locate the **Geometric Entity Selection** section. From the **Geometric entity level** list, choose **Domain**.
- 4 Select Domains 3–5 only.
- 5 Locate the **Variables** section. In the table, enter the following settings:

Name	Expression	Unit	Description
s1	1		

r-Parameterization, Right

- 1 Right-click **Definitions** and choose **Variables**.
- 2 In the **Settings** window for **Variables**, type *r-Parameterization, Right* in the **Label** text field.

- 3 Locate the **Geometric Entity Selection** section. From the **Geometric entity level** list, choose **Domain**.
- 4 Select Domains 8–10 only.
- 5 Locate the **Variables** section. In the table, enter the following settings:

Name	Expression	Unit	Description
s1	$(110[\text{mm}] - R) / (110[\text{mm}] - 65[\text{mm}])$		

COMPONENT I (COMP I)

Now apply the Prescribed Deformation feature to the regions to be deformed only, and prescribe the deformation in terms of the defined variables.

Prescribed Deformation 1

- 1 In the **Model Builder** window, right-click **Component I (comp1)** and choose **Moving Mesh > Prescribed Deformation**.
- 2 In the **Settings** window for **Prescribed Deformation**, locate the **Geometric Entity Selection** section.
- 3 Click  **Clear Selection**.
- 4 Select Domains 3–5 and 8–10 only.
- 5 Locate the **Prescribed Deformation** section. Specify the dx vector as

0	R
$(u - 18[\text{mm}]) * s1 * s2$	Z

STUDY I

Step 1: Time Dependent

- 1 In the **Model Builder** window, expand the **Component I (comp1) > Mesh 1** node, then click **Study 1 > Step 1: Time Dependent**.
- 2 In the **Settings** window for **Time Dependent**, locate the **Study Settings** section.
- 3 In the **Output times** text field, type range (0, 0.01, 1.7).
- 4 From the **Tolerance** list, choose **User controlled**.
- 5 In the **Relative tolerance** text field, type 0.001.

DEFINITIONS

Finally, add probes for the plate displacement variable and the Lorentz force.

Global Variable Probe 1 (var1)

- 1 In the **Definitions** toolbar, click  **Probes** and choose **Global Variable Probe**.
- 2 In the **Settings** window for **Global Variable Probe**, click **Replace Expression** in the upper-right corner of the **Expression** section. From the menu, choose **Component 1 (comp1) > Plate Dynamics > u - Plate position - m**.
- 3 Locate the **Expression** section.
- 4 Select the **Description** checkbox. In the associated text field, type `Plate displacement`.

Global Variable Probe 2 (var2)

- 1 In the **Definitions** toolbar, click  **Probes** and choose **Global Variable Probe**.
- 2 In the **Settings** window for **Global Variable Probe**, locate the **Expression** section.
- 3 In the **Expression** text field, type `mf.Forcez_0`.
- 4 Select the **Description** checkbox.
- 5 Click to expand the **Table and Window Settings** section. From the **Output table** list, choose **New table**.
- 6 From the **Plot window** list, choose **New window**.

STUDY 1

Set up the **Results While Solving** functionality to follow the plate movement and the mesh deformation during the solution process.

Solution 1 (sol1)

In the **Study** toolbar, click  **Show Default Solver**.

RESULTS

In the **Model Builder** window, expand the **Results** node.

Study 1/Solution 1 (sol1)

In the **Model Builder** window, expand the **Results > Datasets** node, then click **Study 1/Solution 1 (sol1)**.

Selection

- 1 In the **Results** toolbar, click  **Attributes** and choose **Selection**.
- 2 In the **Settings** window for **Selection**, locate the **Geometric Entity Selection** section.
- 3 From the **Geometric entity level** list, choose **Domain**.
- 4 Select Domains 3–5 and 8–10 only.

2D Plot Group 1

- 1 In the **Results** toolbar, click  **2D Plot Group**.
- 2 In the **Settings** window for **2D Plot Group**, locate the **Plot Settings** section.
- 3 From the **Frame** list, choose **Spatial (r, phi, z)**.

Mesh 1

- 1 Right-click **2D Plot Group 1** and choose **Mesh**.
- 2 In the **Settings** window for **Mesh**, locate the **Coloring and Style** section.
- 3 From the **Element color** list, choose **None**.
- 4 From the **Wireframe color** list, choose **White**.

Surface 1

- 1 In the **Model Builder** window, right-click **2D Plot Group 1** and choose **Surface**.
- 2 In the **Settings** window for **Surface**, locate the **Expression** section.
- 3 In the **Expression** text field, type `pres1.dz`.

STUDY 1

Step 1: Time Dependent

- 1 In the **Model Builder** window, under **Study 1** click **Step 1: Time Dependent**.
- 2 In the **Settings** window for **Time Dependent**, click to expand the **Results While Solving** section.
- 3 Select the **Plot** checkbox.
- 4 In the **Study** toolbar, click  **Compute** (Notice that the **Graphics** window and the **Probe Plot** windows show the development of the system as it is being computed).

RESULTS

2D Plot Group 1

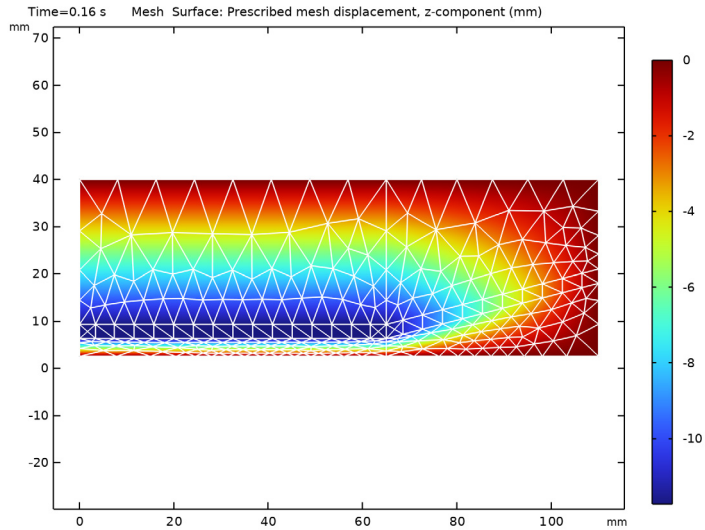

Electromagnetic Force, z-component

- 1 In the **Model Builder** window, under **Results** click **Probe Plot Group 3**.
- 2 In the **Settings** window for **ID Plot Group**, type Electromagnetic Force, z-component in the **Label** text field.
- 3 Click to expand the **Title** section. From the **Title type** list, choose **Manual**.
- 4 In the **Title** text area, type Electromagnetic Force, z-component (N).
- 5 Locate the **Plot Settings** section. Select the **y-axis label** checkbox.
- 6 Clear the **y-axis label** text field.

7 In the **Electromagnetic Force, z-component** toolbar, click  **Plot**.

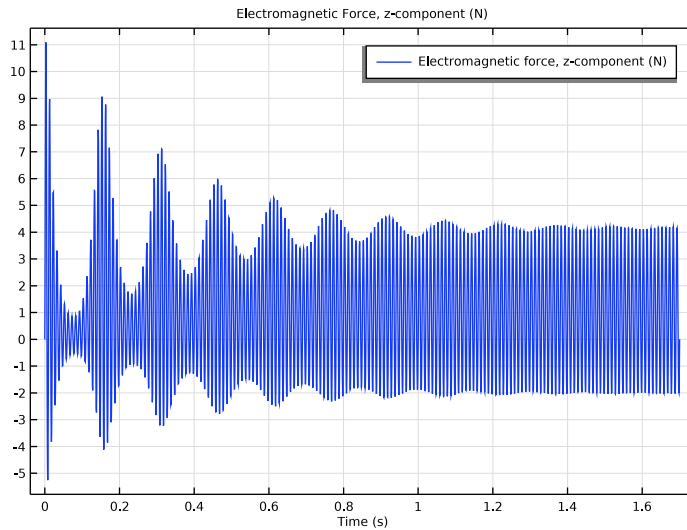

Create a new dataset and a 2D plot of the magnetic flux density.

Study 1/Solution 1 (3) (sol1)

In the **Model Builder** window, under **Results** > **Datasets** right-click **Study 1/Solution 1 (sol1)** and choose **Duplicate**.

Selection

- 1 In the **Model Builder** window, expand the **Study 1/Solution 1 (3) (sol1)** node, then click **Selection**.
- 2 Select Domains 2–5, 7–10, and 12 only (all the domains not belonging to the infinite element region").

2D Plot Group 4

- 1 In the **Results** toolbar, click  **2D Plot Group**.
- 2 In the **Settings** window for **2D Plot Group**, locate the **Data** section.
- 3 From the **Dataset** list, choose **Study 1/Solution 1 (3) (sol1)**.

Surface 1

- 1 Right-click **2D Plot Group 4** and choose **Surface**.
Keep the default quantity to be plotted (the magnetic flux density norm).

Plot the lines of the magnetic flux density field. In 2D axisymmetry, these lines correspond to the isolines of the magnetic vector potential multiplied by the radius. Use a Contour plot to visualize this quantity, as it usually produces a more visually appealing plot.

Contour I

- 1 In the **Model Builder** window, right-click **2D Plot Group 4** and choose **Contour**.
- 2 In the **Settings** window for **Contour**, click **Replace Expression** in the upper-right corner of the **Expression** section. From the menu, choose **Component 1 (comp1) > Magnetic Fields > Magnetic > Magnetic vector potential (spatial frame) - Wb/m > mf.Aphi - Magnetic vector potential, phi-component**.
- 3 Modify the **Expression** to $mf.Aphi*r$
- 4 Locate the **Expression** section. In the **Expression** text field, type $mf.Aphi*r$.
- 5 Locate the **Coloring and Style** section. From the **Coloring** list, choose **Uniform**.
- 6 From the **Color** list, choose **White**.
- 7 Clear the **Color legend** checkbox.

Magnetic Flux Density

- 1 In the **Model Builder** window, under **Results** click **2D Plot Group 4**.
- 2 In the **Settings** window for **2D Plot Group**, type **Magnetic Flux Density** in the **Label** text field.
- 3 Locate the **Data** section. From the **Time (s)** list, choose **0.01**.
- 4 Click to expand the **Title** section. From the **Title type** list, choose **Manual**.
- 5 In the **Title** text area, type **Magnetic flux density norm (T) and streamlines at time=0.01 s**.
- 6 Clear the **Parameter indicator** text field.

7 In the **Magnetic Flux Density** toolbar, click  **Plot**.

Next, import the experimental data and compare with the computed solution.

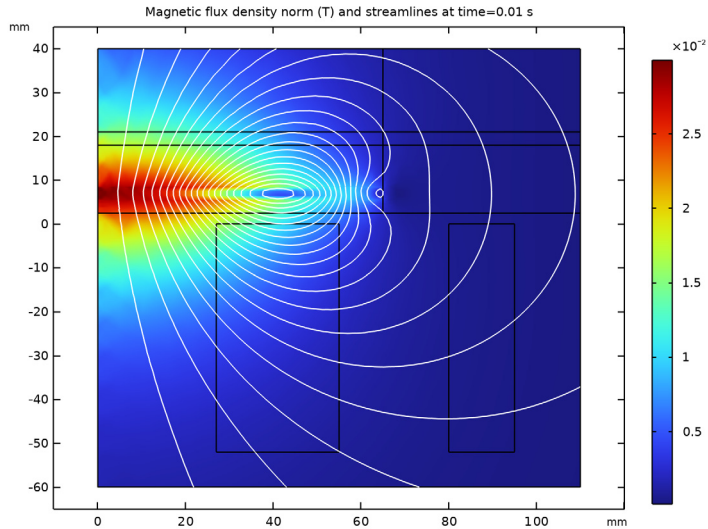

Experimental Data



- 1 In the **Results** toolbar, click  **Table**.
- 2 In the **Settings** window for **Table**, type Experimental Data in the **Label** text field.
- 3 Locate the **Data** section. Click  **Import**.
- 4 Browse to the model's Application Libraries folder and double-click the file electrodynamic_levitation_device_data.txt.

Plate Dynamics Comparison

- 1 In the **Model Builder** window, under **Results** click **Probe Plot Group 2**.
- 2 In the **Settings** window for **ID Plot Group**, type Plate Dynamics Comparison in the **Label** text field.
- 3 Locate the **Title** section. From the **Title type** list, choose **Manual**.
- 4 In the **Title** text area, type Axial Plate Displacement (mm).
- 5 Locate the **Plot Settings** section. Select the **x-axis label** checkbox.

Probe Table Graph 1

- 1 In the **Model Builder** window, expand the **Plate Dynamics Comparison** node, then click **Probe Table Graph 1**.
- 2 In the **Settings** window for **Table Graph**, click to expand the **Legends** section.

- 3 From the **Legends** list, choose **Manual**.
- 4 In the first row of the table, type **Computed**.

Table Graph 2

- 1 In the **Model Builder** window, right-click **Plate Dynamics Comparison** and choose **Table Graph**.
- 2 In the **Settings** window for **Table Graph**, locate the **Data** section.
- 3 From the **Table** list, choose **Experimental Data**.
- 4 Locate the **Coloring and Style** section. Find the **Line markers** subsection. From the **Marker** list, choose **Cycle**.
- 5 Find the **Line style** subsection. From the **Line** list, choose **None**.
- 6 Locate the **Legends** section. Select the **Show legends** checkbox.
- 7 From the **Legends** list, choose **Manual**.
- 8 In the first row of the table, type **Experimental**.
- 9 In the **Plate Dynamics Comparison** toolbar, click  **Plot**.

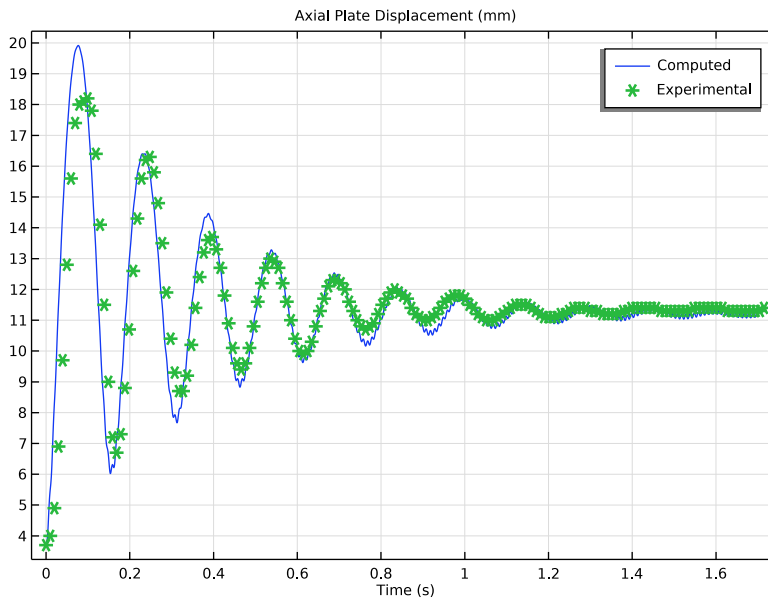

Study 1/Solution 1 (3) (sol1)

Visualize the complete 3D geometry with a revolution dataset.

Study 1/Solution 1 (4) (sol1)

In the **Model Builder** window, under **Results** > **Datasets** right-click **Study 1/Solution 1 (3) (sol1)** and choose **Duplicate**.

Selection

- 1 In the **Model Builder** window, expand the **Study 1/Solution 1 (4) (sol1)** node, then click **Selection**.
- 2 Select Domains 4, 7, and 12 only (the two coils and the plate).

Revolution 2D 1

- 1 In the **Results** toolbar, click  **More Datasets** and choose **Revolution 2D**.
- 2 In the **Settings** window for **Revolution 2D**, locate the **Data** section.
- 3 From the **Dataset** list, choose **Study 1/Solution 1 (4) (sol1)**.
- 4 Click to expand the **Revolution Layers** section. In the **Start angle** text field, type -90.
- 5 In the **Revolution angle** text field, type 240.
- 6 In the **Start angle** text field, type 0.
- 7 In the **Revolution angle** text field, type 360.

3D Plot Group 5

In the **Results** toolbar, click  **3D Plot Group**.

Volume 1

- 1 Right-click **3D Plot Group 5** and choose **Volume**.
- 2 In the **Settings** window for **Volume**, click **Replace Expression** in the upper-right corner of the **Expression** section. From the menu, choose **Component 1 (comp1)** > **Magnetic Fields** > **Currents and charge** > **Current density (spatial frame) - A/m²** > **mf.jphi - Current density, phi-component**.

Current Density

- 1 In the **Model Builder** window, under **Results** click **3D Plot Group 5**.
- 2 In the **Settings** window for **3D Plot Group**, type Current Density in the **Label** text field.
- 3 Locate the **Plot Settings** section. From the **Frame** list, choose **Spatial (r, phi, z)**.

4 In the **Current Density** toolbar, click  **Plot**.

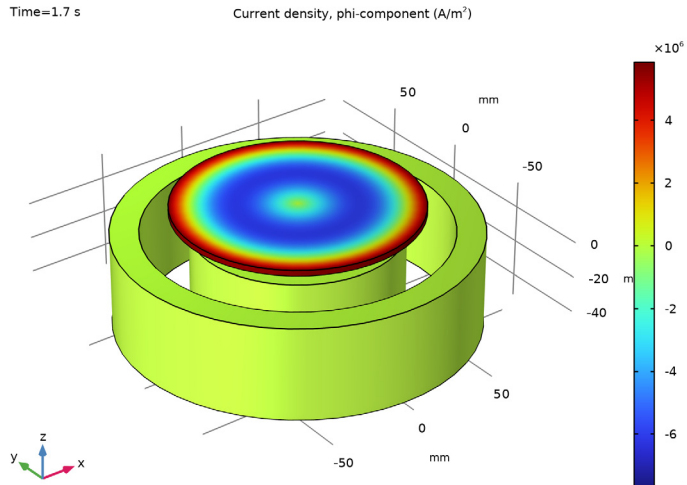

Animation 1

Finally, create an animation of the moving plate.

- 1 In the **Results** toolbar, click  **Animation** and choose **Player**.
- 2 In the **Settings** window for **Animation**, locate the **Scene** section.
- 3 From the **Subject** list, choose **Current Density**.
- 4 Locate the **Animation Editing** section. From the **Time selection** list, choose **From list**.
- 5 From the **Times (s)** list, choose all the time steps up to 1.2.
- 6 Locate the **Frames** section. In the **Number of frames** text field, type 50.
- 7 In the **Graphics** toolbar, click **Play**.