



Model created in COMSOL Multiphysics 6.4

Modeling a Capacitive Position Sensor Using BEM

Introduction

This electrostatics tutorial model uses the Electrostatics, Boundary Elements physics interface to model a five-terminal capacitive sensor and compute its capacitance matrix. The interelectrode capacitances (capacitance matrix elements) are influenced by the presence of a metallic test object and the model is solved for a range of test object positions. The model serves as a tutorial on how to extract lumped parameter matrices using the Stationary Source Sweep study. It is similar to the [Modeling a Capacitive Position Sensor Using FEM](#) model that uses the finite element method (FEM) featured in the Electrostatics physics interface. That model also provides a more comprehensive description of the Stationary Source Sweep study functionality. The main focus of this model is on how to use the boundary element method (BEM) for the task of analyzing the sensor.

Model Definition

When using FEM, it is necessary to have a volumetric mesh in a portion of the surrounding air and in all dielectrics. An advantage of BEM is that meshing is only needed for object surfaces. More generally, the mesh is needed only on conductor surfaces and at the interfaces where dielectric properties change. For modeling the sensor and the infinite surrounding space, building the boundary mesh represented in [Figure 1](#) is enough.

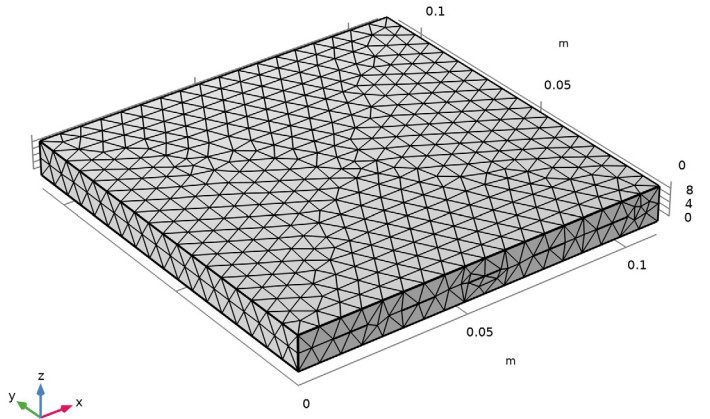

Figure 1: The boundary mesh of the sensor.

Similarly, when introducing the metallic test object, the full geometry is shown in [Figure 2](#) and [Figure 3](#) (in different positions). An air domain is not necessary, and only the natural object boundaries need to be included.

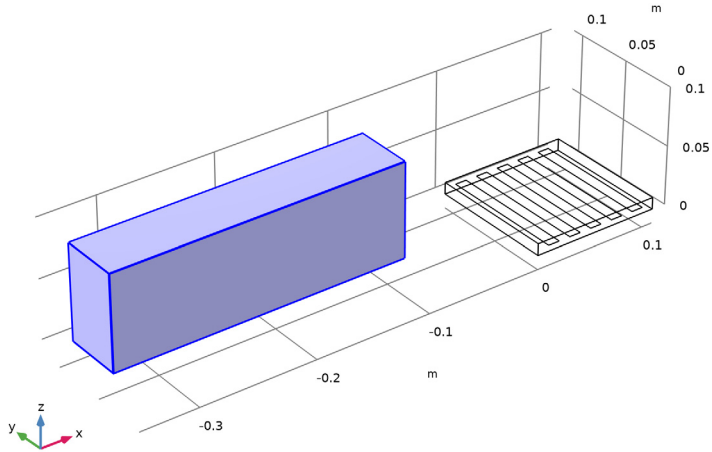

Figure 2: The test object when it is far from the sensor.

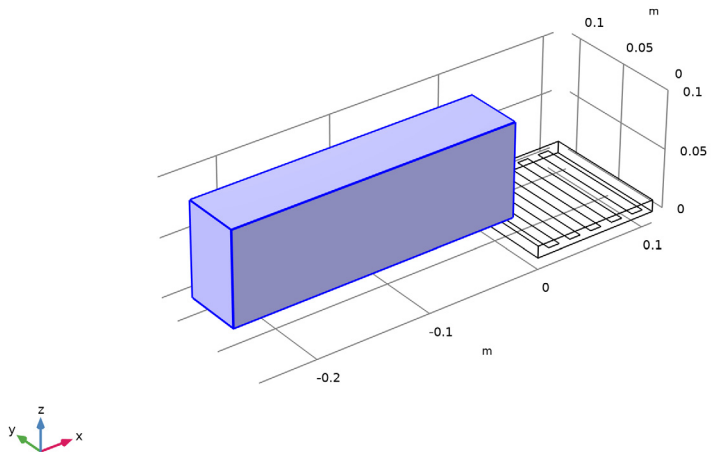

Figure 3: The test object when it is approaching the sensor.

Moreover, since the metallic block moves as a rigid body, there is no need to create a new mesh when its position changes. The translation of the mesh is obtained by using the Deformed Geometry feature.

Results and Discussion

Even though there is no mesh in the air, COMSOL Multiphysics produces default plots of the fields in volumes. One such electric potential plot is shown in Figure 4, where a slice of the electric potential in air is represented.

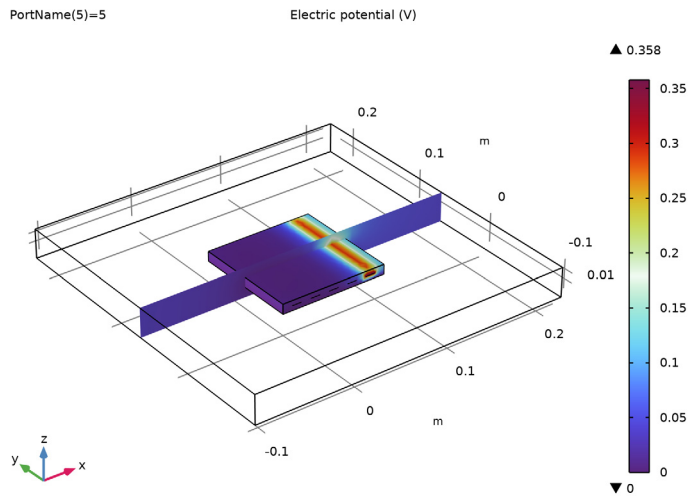

Figure 4: Electric potential in the infinite space outside the object.

As for the FEM-based Electrostatics interface, the capacitance matrix output is provided. Figure 5 represents the mutual capacitance matrix, in units of pF, when the test object is absent.

FEM and BEM results agree within an error margin of about 8% (considering the absolute value of the Maxwell capacitance). Changes in capacitance due to the sensed object are reproduced within about 1%. FEM and BEM should be seen as complementary methods.

Both are suitable for studying the capacitive position sensor system and the preferred method depends on the details of the simulation.

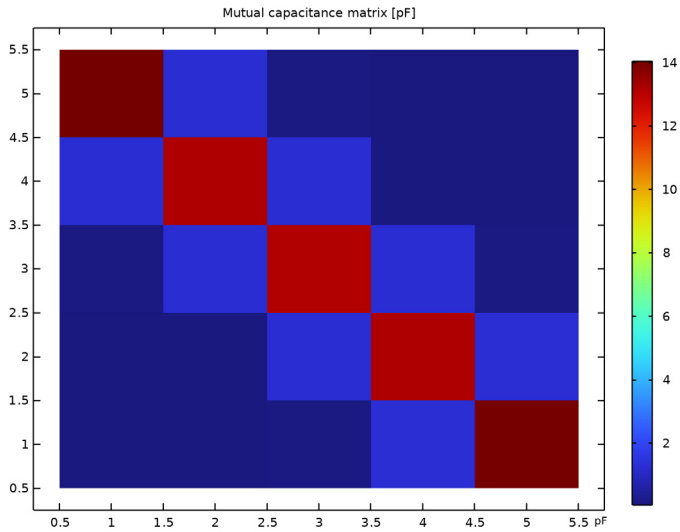

Figure 5: Mutual capacitance matrix.

Figure 6 and Figure 7 show the electric potential (log scale) with the first terminal excited and when the test object is far from or just above the sensor, respectively. The presence of the metallic block changes the accumulated surface charge on the sensor electrodes and influences their capacitance values.

The BEM model accounts for the change in capacitance when the object is far away a lot more accurately. It can be verified that the absolute capacitance for the position shown in [Figure 2](#) already has changed on the order of a percent with respect to the complete absence of the object.

The response of the inverse Maxwell capacitance for different positions of the test object is shown in [Figure 8](#). The relative change is shown with respect to when the block is in the position shown in [Figure 2](#). The blue curve in [Figure 8](#) represents the change in inverse Maxwell self-capacitance of the electrode that initially is closest to the test object. The green curve represents the change in inverse Maxwell self-capacitance of the electrode that initially is farthest from the test object.

The absolute capacitance of an electrode may exhibit a long-term drift, so measuring relative changes in interelectrode capacitance is more robust. The ratio of relative change in inverse Maxwell self-capacitance of the first versus the last electrode is represented by the red curve in [Figure 8](#). It is clear that the test object produces a change in the response of the nearest electrode with respect to the farthest electrode. This can trigger properly designed feeding circuitry that detects the presence of the object.

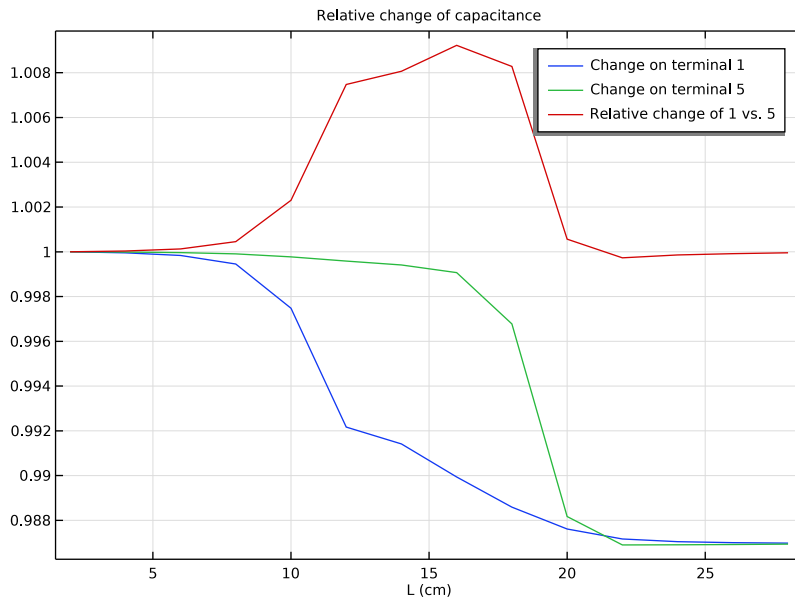



Figure 8: Change in inverse Maxwell capacitance as a function of position of the incoming metal object. The blue and green lines are the absolute changes of the nearest and the farthest electrodes, respectively. The ratio of relative change of the nearest to the farthest electrode is shown in red.

Application Library path: ACDC_Module/Devices,_Capacitive/
capacitive_position_sensor_bem



Modeling Instructions

From the **File** menu, choose **New**.

NEW

In the **New** window, click  **Model Wizard**.

MODEL WIZARD



- 1 In the **Model Wizard** window, click  **3D**.
- 2 In the **Select Physics** tree, select **AC/DC > Electric Fields and Currents > Electrostatics, Boundary Elements (esbe)**.
- 3 Click **Add**.
- 4 Click  **Study**.
- 5 In the **Select Study** tree, select **Preset Studies for Selected Physics Interfaces > Stationary Source Sweep**.
- 6 Click  **Done**.

GEOMETRY I

Block 1 (blk1)

- 1 In the **Geometry** toolbar, click  **Block**.
- 2 In the **Settings** window for **Block**, locate the **Size and Shape** section.
- 3 In the **Width** text field, type 11 [cm].
- 4 In the **Depth** text field, type 11 [cm].
- 5 In the **Height** text field, type 1 [cm].



Work Plane 1 (wpl)

- 1 In the **Geometry** toolbar, click  **Work Plane**.
- 2 In the **Settings** window for **Work Plane**, locate the **Plane Definition** section.
- 3 In the **z-coordinate** text field, type 5 [mm].
- 4 Click  **Go to Plane Geometry**.



Work Plane 1 (wp1) > Rectangle 1 (r1)

- 1 In the **Work Plane** toolbar, click  **Rectangle**.
- 2 In the **Settings** window for **Rectangle**, locate the **Size and Shape** section.
- 3 In the **Width** text field, type 1 [cm].
- 4 In the **Height** text field, type 11 [cm].
- 5 Locate the **Position** section. In the **xw** text field, type 1 [cm].

Work Plane 1 (wp1) > Array 1 (arr1)



- 1 In the **Work Plane** toolbar, click  **Transforms** and choose **Array**.
- 2 Select the object **r1** only.
- 3 In the **Settings** window for **Array**, locate the **Size** section.
- 4 In the **xw size** text field, type 5.
- 5 Locate the **Displacement** section. In the **xw** text field, type 2 [cm].
- 6 Click  **Build Selected**.

Work Plane 1 (wp1)

- 1 In the **Model Builder** window, under **Component 1 (comp1) > Geometry 1** click **Work Plane 1 (wp1)**.
- 2 In the **Settings** window for **Work Plane**, click  **Build Selected**.
- 3 Click the  **Wireframe Rendering** button in the **Graphics** toolbar.

The following operations are needed to load materials. Pay special attention to the fact that **Air**, which is not necessarily explicitly modeled in a boundary element approach, will be added to the **Infinite void** entity, available under the **Domain Geometric entity level**.

ADD MATERIAL

- 1 In the **Materials** toolbar, click  **Add Material** to open the **Add Material** window.
- 2 Go to the **Add Material** window.
- 3 In the tree, select **Built-in > Air**.
- 4 Right-click and choose **Add to Component 1 (comp1)**.
- 5 In the tree, select **Built-in > Nylon**.
- 6 Right-click and choose **Add to Component 1 (comp1)**.
- 7 In the **Materials** toolbar, click  **Add Material** to close the **Add Material** window.

MATERIALS

Nylon (mat2)

Select Domain 1 only.

Air (mat1)

- 1 In the **Model Builder** window, click **Air (mat1)**.
- 2 In the **Settings** window for **Material**, locate the **Geometric Entity Selection** section.
- 3 From the **Selection** list, choose **All voids**.

ELECTROSTATICS, BOUNDARY ELEMENTS (ESBE)

Charge Conservation 2

- 1 In the **Physics** toolbar, click  **Domains** and choose **Charge Conservation**.
- 2 Select Domain 1 only.

Add ground and terminals for the feeding.

Ground 1

- 1 In the **Physics** toolbar, click  **Boundaries** and choose **Ground**.
- 2 Select Boundary 3 only.

Boundary Terminal 1

- 1 In the **Physics** toolbar, click  **Boundaries** and choose **Boundary Terminal**.
- 2 Select Boundary 6 only.

Boundary Terminal 2

- 1 In the **Physics** toolbar, click  **Boundaries** and choose **Boundary Terminal**.
- 2 Select Boundary 7 only.

Boundary Terminal 3

- 1 In the **Physics** toolbar, click  **Boundaries** and choose **Boundary Terminal**.
- 2 Select Boundary 8 only.

Boundary Terminal 4

- 1 In the **Physics** toolbar, click  **Boundaries** and choose **Boundary Terminal**.
- 2 Select Boundary 9 only.

Boundary Terminal 5

- 1 In the **Physics** toolbar, click  **Boundaries** and choose **Boundary Terminal**.
- 2 Select Boundary 10 only.

Generate the physics induced mesh for the sensor, which should be similar [Figure 1](#) in the introduction.

MESH 1

- 1 In the **Model Builder** window, under **Component 1 (comp1)** click **Mesh 1**.
- 2 In the **Settings** window for **Mesh**, locate the **Physics-Controlled Mesh** section.
- 3 From the **Element size** list, choose **Finer**.
- 4 In the table, clear the **Use** checkbox for **Geometric Analysis, Detail Size**.
- 5 Click  **Build All**.



The problem could be directly solved as it is, but for optimizing solution performance, a direct solver and linear elements are selected.

ELECTROSTATICS, BOUNDARY ELEMENTS (ESBE)

- 1 In the **Model Builder** window, under **Component 1 (comp1)** click **Electrostatics, Boundary Elements (esbe)**.
- 2 In the **Settings** window for **Electrostatics, Boundary Elements**, click to expand the **Discretization** section.
- 3 From the **Electric potential/Surface charge density** list, choose **Linear/Linear**.

STUDY 1

Solution 1 (sol1)

- 1 In the **Study** toolbar, click  **Show Default Solver**.
- 2 In the **Model Builder** window, expand the **Solution 1 (sol1)** node.
- 3 In the **Model Builder** window, expand the **Study 1 > Solver Configurations > Solution 1 (sol1) > Stationary Solver 1** node.
- 4 Right-click **Study 1 > Solver Configurations > Solution 1 (sol1) > Stationary Solver 1 > Direct** and choose **Enable**.
- 5 In the **Study** toolbar, click  **Compute**.

RESULTS

Electric Potential (esbe)

Make the following modifications to the default plots in order to reproduce the figures in the introduction. Note that the potential is displayed also in the unmeshed air regions.

Streamline Multislice 1

- 1 In the **Model Builder** window, expand the **Electric Potential (esbe)** node.
- 2 Right-click **Streamline Multislice 1** and choose **Disable**.

Multislice 1

- 1 In the **Model Builder** window, click **Multislice 1**.
- 2 In the **Settings** window for **Multislice**, locate the **Multipane Data** section.
- 3 Find the **x-planes** subsection. In the **Planes** text field, type 0.
- 4 Find the **z-planes** subsection. In the **Planes** text field, type 0.
- 5 In the **Electric Potential (esbe)** toolbar, click  **Plot**.

The following operations generate the lumped capacitance matrices and a 2D plot of the mutual capacitance matrix. The plot should be similar to [Figure 5](#) in the introduction.

Lumped Parameters (dset1, esbe)

In the **Model Builder** window, expand the **Results > Lumped Parameters (dset1, esbe)** node.

Maxwell capacitance (dset1, esbe)

In the **Model Builder** window, expand the **Results > Lumped Parameters (dset1, esbe) > Maxwell capacitance (dset1, esbe)** node.

Maxwell capacitance (dset1, esbe)

- 1 In the **Model Builder** window, expand the **Results > Lumped Parameters (dset1, esbe) > Mutual capacitance (dset1, esbe)** node, then click **Results > Lumped Parameters (dset1, esbe) > Maxwell capacitance (dset1, esbe) > Maxwell capacitance (dset1, esbe)**.
- 2 In the **Settings** window for **Global Matrix Evaluation**, locate the **Expression** section.
- 3 From the **Unit** list, choose **I/pF**.

Mutual capacitance (dset1, esbe)

- 1 In the **Model Builder** window, under **Results > Lumped Parameters (dset1, esbe) > Mutual capacitance (dset1, esbe)** click **Mutual capacitance (dset1, esbe)**.
- 2 In the **Settings** window for **Global Matrix Evaluation**, locate the **Expression** section.
- 3 From the **Unit** list, choose **I/pF**.
- 4 In the **Results** toolbar, click  **Evaluate** and choose **Clear and Evaluate All**.

MUTUAL CAPACITANCE (DSET1, ESBE)



- 1 Go to the **Mutual capacitance (dset1, esbe)** window.
- 2 Click the **Table Surface** button in the window toolbar.

RESULTS

Table Surface 1

- 1 In the **Settings** window for **Table Surface**, locate the **Data** section.
- 2 From the **Data format** list, choose **Cells**.
- 3 Locate the **Coloring and Style** section. From the **Function** list, choose **Discrete**.

Mutual Capacitance Matrix

- 1 In the **Model Builder** window, under **Results** click **2D Plot Group 3**.
- 2 In the **Settings** window for **2D Plot Group**, type Mutual Capacitance Matrix in the **Label** text field.
- 3 Click to expand the **Title** section. From the **Title type** list, choose **Manual**.
- 4 In the **Title** text area, type Mutual capacitance matrix [pF].
- 5 In the **Mutual Capacitance Matrix** toolbar, click  **Plot**.
- 6 Click the  **Zoom Extents** button in the **Graphics** toolbar.

Addition of the Sensed Metallic Object

Next, a metallic block is placed close to the sensor. The accumulated charge on the terminals will be influenced by the block. This makes it possible to determine the position of the block. As air does not need to be modeled, remeshing is not strictly necessary. To avoid remeshing the displacement is included by adding a **Deformed Geometry** node, meshing sensor and block in their base position. The displacement **L** is then applied to the **Deformed Geometry** and does not appear in the geometry.

GLOBAL DEFINITIONS



Parameters 1

- 1 In the **Model Builder** window, under **Global Definitions** click **Parameters 1**.
- 2 In the **Settings** window for **Parameters**, locate the **Parameters** section.
- 3 In the table, enter the following settings:

Name	Expression	Value	Description
L	2[cm]	0.02 m	Displacement

GEOMETRY I

Block 2 (blk2)

- 1 In the **Geometry** toolbar, click  **Block**.
- 2 In the **Settings** window for **Block**, locate the **Object Type** section.
- 3 From the **Type** list, choose **Surface**.
- 4 Locate the **Size and Shape** section. In the **Width** text field, type 25[cm].
- 5 In the **Depth** text field, type 5[cm].
- 6 In the **Height** text field, type 8[cm].
- 7 Locate the **Position** section. In the **x** text field, type -35[cm].
- 8 In the **y** text field, type 3[cm].
- 9 In the **z** text field, type 2[cm].
- 10 Click  **Build All Objects**.

COMPONENT I (COMP1)

Prescribed Deformation I

In the **Physics** toolbar, click  **Deformed Geometry** and choose **Prescribed Deformation**.

DEFORMED GEOMETRY



- 1 In the **Model Builder** window, expand the **Component I (comp1) > Definitions** node, then click **Component I (comp1) > Deformed Geometry > Prescribed Deformation I**.
- 2 In the **Settings** window for **Prescribed Deformation**, locate the **Geometric Entity Selection** section.
- 3 From the **Geometric entity level** list, choose **Boundary**.
- 4 Select Boundaries 1–6 only.
- 5 Locate the **Prescribed Deformation** section. Specify the dx vector as

$\begin{matrix} \text{L} & \text{X} \\ \hline \end{matrix}$

The block boundaries are defined as an equipotential with no net accumulated charge, by assigning the **Floating Potential** boundary condition to the block boundaries. In this model, there is no need to know the interior material properties of the block as there will be no resulting electric fields inside.

ELECTROSTATICS, BOUNDARY ELEMENTS (ESBE)

Floating Potential I



- 1 In the **Physics** toolbar, click  **Boundaries** and choose **Floating Potential**.
- 2 Select Boundaries 1–6 only.
- 3 In the **Model Builder** window, click **Electrostatics, Boundary Elements (esbe)**.
- 4 In the **Settings** window for **Electrostatics, Boundary Elements**, locate the **Domain Selection** section.
- 5 In the list box, select **Finite void 1**.
- 6 Click  **Remove from Selection**.
- 7 Select Domains –1 only.

MESH I

- 1 In the **Model Builder** window, under **Component 1 (comp1)** click **Mesh 1**.
- 2 In the **Settings** window for **Mesh**, locate the **Physics-Controlled Mesh** section.
- 3 From the **Element size** list, choose **Extremely fine**.
- 4 Click  **Build All**.

STUDY I

Parametric Sweep

- 1 In the **Study** toolbar, click  **Parametric Sweep**.
- 2 In the **Settings** window for **Parametric Sweep**, locate the **Study Settings** section.
- 3 Click  **Add**.
- 4 In the table, enter the following settings:

Parameter name	Parameter value list	Parameter unit
L (Displacement)	range (2, 2, 28)	cm

- 5 In the **Study** toolbar, click  **Compute**.

RESULTS

Electric Potential (esbe) I

Once the solution is generated, the postprocessing can be performed. The creation of the cut plane in air is first performed.

Surface 1

- 1 In the **Model Builder** window, expand the **Electric Potential (esbe) 1** node.
- 2 Right-click **Surface 1** and choose **Disable**.

Electric Potential (esbe) 1

- 1 In the **Model Builder** window, click **Electric Potential (esbe) 1**.
- 2 In the **Settings** window for **3D Plot Group**, locate the **Data** section.
- 3 Click  **Go to Source**.



Grid 3D 2

- 1 In the **Model Builder** window, under **Results > Datasets** click **Grid 3D 2**.
- 2 In the **Settings** window for **Grid 3D**, locate the **Parameter Bounds** section.
- 3 Find the **First parameter** subsection. In the **Minimum** text field, type -0.2.
- 4 In the **Maximum** text field, type 0.2.
- 5 Click to expand the **Grid** section. In the **x resolution** text field, type 100.

Streamline Multislice 1

- 1 In the **Model Builder** window, under **Results > Electric Potential (esbe) 1** right-click **Streamline Multislice 1** and choose **Disable**.
- 2 Click the  **Go to Default View** button in the **Graphics** toolbar.

Multislice 1

- 1 In the **Model Builder** window, click **Multislice 1**.
- 2 In the **Settings** window for **Multislice**, locate the **Multiplane Data** section.
- 3 Find the **x-planes** subsection. In the **Planes** text field, type 0.
- 4 Find the **z-planes** subsection. In the **Planes** text field, type 0.
- 5 In the **Electric Potential (esbe) 1** toolbar, click  **Plot**.
- 6 Click the  **Go to Default View** button in the **Graphics** toolbar.
- 7 Click the  **Zoom Extents** button in the **Graphics** toolbar.

Electric Potential (esbe) 1

- 1 In the **Model Builder** window, click **Electric Potential (esbe) 1**.
- 2 In the **Settings** window for **3D Plot Group**, locate the **Data** section.
- 3 From the **Parameter value (L (cm))** list, choose **2**.
- 4 In the **Electric Potential (esbe) 1** toolbar, click  **Plot**.

As the potential differences due to the change of position for the moving object are difficult to notice in linear scale, display the logarithm of the electric potential.

Multislice 1

- 1 In the **Model Builder** window, click **Multislice 1**.
- 2 In the **Settings** window for **Multislice**, locate the **Expression** section.
- 3 In the **Expression** text field, type $\log_{10}(\text{esbe.V})$.
- 4 Click to expand the **Range** section. Select the **Manual color range** checkbox.
- 5 In the **Minimum** text field, type -4.
- 6 In the **Maximum** text field, type 0.
- 7 In the **Electric Potential (esbe) 1** toolbar, click  **Plot**.

Electric Potential (esbe) 1

- 1 In the **Model Builder** window, click **Electric Potential (esbe) 1**.
- 2 In the **Settings** window for **3D Plot Group**, locate the **Data** section.
- 3 From the **Parameter value (PortName)** list, choose **1**.

The resulting plot for the object positioned far from the sensing electrodes should be similar to [Figure 6](#) in the introduction. By changing the value of the displacement **L**, plots of the potential at other positions can be produced.

- 4 In the **Electric Potential (esbe) 1** toolbar, click  **Plot**.
- 5 From the **Parameter value (L (cm))** list, choose **10**.

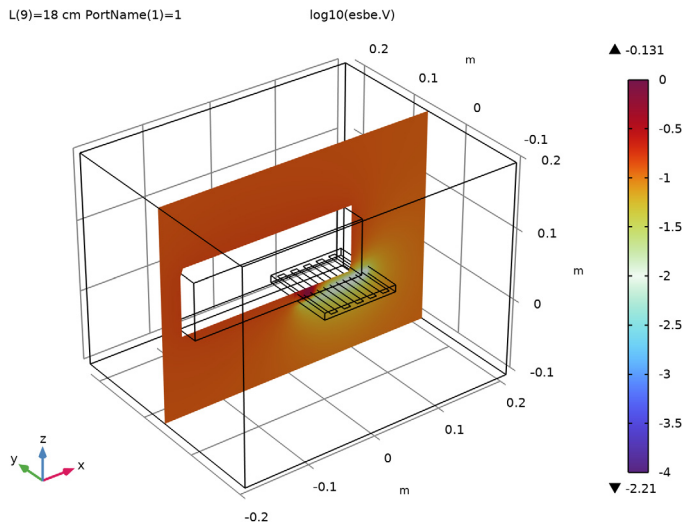

Finally, produce a plot of the change in capacitance as a function of the change in position of the object. The results are similar to those in the *Capacitive Position Sensor* tutorial model, where the **Electrostatics** physics interface is used. The discrepancies between the results are mainly due to the different boundary conditions.

Capacitance Comparison

- 1 In the **Results** toolbar, click  **ID Plot Group**.
- 2 In the **Settings** window for **ID Plot Group**, type Capacitance Comparison in the **Label** text field.
- 3 Locate the **Data** section. From the **Dataset** list, choose **Study 1/ Parametric Solutions 1 (sol2)**.
- 4 From the **Parameter selection (PortName)** list, choose **First**.
- 5 Click to expand the **Title** section. From the **Title type** list, choose **Manual**.
- 6 In the **Title** text area, type Relative change of capacitance.

Global 1

- 1 Right-click **Capacitance Comparison** and choose **Global**.
- 2 In the **Settings** window for **Global**, locate the **y-Axis Data** section.
- 3 In the table, enter the following settings:

Expression	Unit	Description
<code>with(1,esbe.Cinv11)/withsol('sol2',with(1,esbe.Cinv11),setval(L,0.02))</code>	1	Terminal 1
<code>with(5,esbe.Cinv55)/withsol('sol2',with(5,esbe.Cinv55),setval(L,0.02))</code>	1	Terminal 5
<code>with(5,esbe.Cinv55)/with(1,esbe.Cinv11)/withsol('sol2',with(5,esbe.Cinv55)/with(1,esbe.Cinv11),setval(L,0.02))</code>	1	Ratio of capacitances for terminal 1 vs. 5

- 4 Locate the **x-Axis Data** section. From the **Axis source data** list, choose **L**.
- 5 Click to expand the **Legends** section. From the **Legends** list, choose **Manual**.

6 In the table, enter the following settings:

Legends

Change on terminal 1

Change on terminal 5

Relative change of 1 vs. 5

7 In the **Capacitance Comparison** toolbar, click  **Plot**. The resulting plot should reproduce [Figure 8](#) in the introduction.