



# INTRODUCTION TO MEMS Module

# Introduction to the MEMS Module

© 1998–2025 COMSOL

Protected by patents listed on [www.comsol.com/patents](http://www.comsol.com/patents), or see Help > About COMSOL Multiphysics on the File menu in the COMSOL Desktop for less detailed lists of U.S. Patents that may apply. Patents pending.

This Documentation and the Programs described herein are furnished under the COMSOL Software License Agreement ([www.comsol.com/sla](http://www.comsol.com/sla)) and may be used or copied only under the terms of the license agreement.

COMSOL, the COMSOL logo, COMSOL Multiphysics, COMSOL Desktop, COMSOL Compiler, COMSOL Server, and LiveLink are either registered trademarks or trademarks of COMSOL AB. All other trademarks are the property of their respective owners, and COMSOL AB and its subsidiaries and products are not affiliated with, endorsed by, sponsored by, or supported by those trademark owners. For a list of such trademark owners, see [www.comsol.com/trademarks](http://www.comsol.com/trademarks).

Version: COMSOL 6.4

## Contact Information

Visit the Contact COMSOL page at [www.comsol.com/contact](http://www.comsol.com/contact) to submit general inquiries or search for an address and phone number. You can also visit the Worldwide Sales Offices page at [www.comsol.com/contact/offices](http://www.comsol.com/contact/offices) for address and contact information.

If you need to contact Support, an online request form is located on the COMSOL Access page at [www.comsol.com/support/case](http://www.comsol.com/support/case). Useful links:

- Support Center: [www.comsol.com/support](http://www.comsol.com/support)
- Product Download: [www.comsol.com/product-download](http://www.comsol.com/product-download)
- Product Updates: [www.comsol.com/product-update](http://www.comsol.com/product-update)
- COMSOL Blog: [www.comsol.com/blogs](http://www.comsol.com/blogs)
- Discussion Forum: [www.comsol.com/forum](http://www.comsol.com/forum)
- Events: [www.comsol.com/events](http://www.comsol.com/events)
- COMSOL Video Gallery: [www.comsol.com/videos](http://www.comsol.com/videos)
- Support Knowledge Base: [www.comsol.com/support/knowledgebase](http://www.comsol.com/support/knowledgebase)
- Learning Center: [www.comsol.com/support/learning-center](http://www.comsol.com/support/learning-center)

Part number: CM020904

# Contents

---

The MEMS Module .....	5
MEMS Devices: Physics and Applications .....	7
The MEMS Module Physics Interface Guide .....	13
Physics Interface Guide by Space Dimension and Preset Study Type .....	19
Tutorial Model: Modeling a Capacitive Pressure Sensor .....	27



## The MEMS Module

---

The MEMS Module is used by engineers and scientists to understand, predict, and design microsystems. The use of simulation tools in the design cycle can enhance understanding, reduce prototyping, and ultimately produce better products with lower development costs. The MEMS Module makes it possible to quickly and accurately predict the structural, electrical, and thermal performance of MEMS devices. The built-in multiphysics capabilities in COMSOL Multiphysics make it straightforward to model devices in which different physical effects are coupled, making it particularly suited to address a wide range of problems encountered in MEMS design.

The MEMS Module enables the stationary and dynamic performance of devices to be modeled in two and three dimensions, together with circuit-based modeling of active and passive devices. In the frequency domain, powerful tools are available to model devices driven by a combination of AC and DC signals or forces. Predefined physics interfaces, referred to as MEMS physics interfaces, address a wide range of physical phenomena that are employed in MEMS sensors and actuators. MEMS physics interfaces are available for simulating structural mechanics, electrostatics, electric currents, piezoelectricity, piezoresistivity, thin-film fluid flow, heat transfer, and electrical circuits. These physics interfaces can also be coupled arbitrarily to solve multiphysics problems, and a number of predefined couplings are also available as MEMS physics interfaces. These include electromechanics (for combining electrostatic forces with structural mechanics), Joule heating, Joule heating and thermal expansion, and fluid-structure interaction (for combining fluid flow with structural mechanics).

For each of the MEMS physics interfaces, the underlying physical principles are expressed in the form of partial differential equations, together with corresponding initial and boundary conditions. COMSOL's design emphasizes the physics by providing users with the equations solved by each feature and offering the user full access to the underlying equation system. There is also tremendous flexibility to add user-defined equations and expressions to the system. For example, to model Joule heating in a structure with temperature-dependent elastic properties, simply enter in the elastic constants as a function of temperature — no scripting or coding is required. When COMSOL Multiphysics compiles the equations, the complex couplings generated by these user-defined expressions are automatically included in the equation system. The equations are then solved using the finite element method and a range of industrial strength solvers. Once a solution is obtained, a vast range of postprocessing tools are available to analyze the data, and predefined plots are automatically generated to show the device response. COMSOL Multiphysics offers the flexibility to evaluate and visualize a wide range of physical quantities, including predefined

quantities such as the temperature, the electric field, or the stress tensor (available through easy-to-use menus), as well as arbitrary user-defined expressions.

To model a MEMS device the geometry is first defined in the software (or imported from a CAD file or system). Then appropriate materials are selected and a suitable MEMS physics interface is added. Initial conditions and boundary conditions are set up within the physics interface. Next, the mesh is defined and a solver is selected. Finally the results are visualized using a wide range of postprocessing tools. All of these steps are accessed from the COMSOL Desktop graphical user interface.

## MEMS Devices: Physics and Applications

---

The smaller size of MEMS devices has important effects on the physical processes that govern their operation. The MEMS physics interfaces allow the simulation of the important physical effects that dominate at the microscale.

In general, as the length scale ( $L$ ) of the device is reduced, the scaling of a physical effect with respect to  $L$  determines its relative importance. The inertial force required to produce a fixed acceleration of a solid body scales volumetrically as  $L^3$ . The scaling of other forces in comparison to this inertial force has important consequences for MEMS devices. For example, the effective spring constant for a body scales as  $L^1$ . The spring stiffness therefore decreases much more slowly than the system mass as the size of the system is reduced, resulting in higher resonant frequencies for smaller devices (resonant frequency scales as  $L^{-1}$ ). This means that micromechanical systems typically have higher operating frequencies and faster response times than macroscopic systems.

Electrostatic forces scale favorably as the device dimensions are reduced (for example, the force between parallel plates with a fixed applied voltage scales as  $L^0$ ). Additionally, electrostatic actuators consume no DC power and can be manufactured using processes that are compatible with standard semiconductor foundries. Many MEMS devices utilize electrostatic actuation for this reason.

The following image shows the mode shape for an electrostatically actuated MEMS resonator, which is operated with an applied DC bias. The graph shows that the resonant frequency decreases as the applied potential increases; this is due to the softening of the coupled electromechanical system. The small size of the device results in a MHz resonant frequency even for a simple flexural mode. In addition the favorable scaling of the electromagnetic forces enables efficient capacitive actuation that would not be possible on the macroscale.

Eigenfrequency=8.2479E6 Hz

Displacement magnitude ( $\mu\text{m}$ )

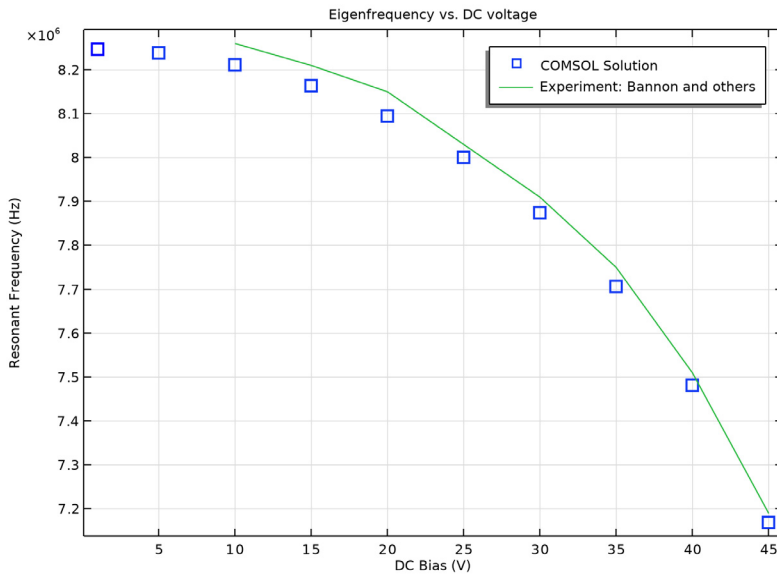
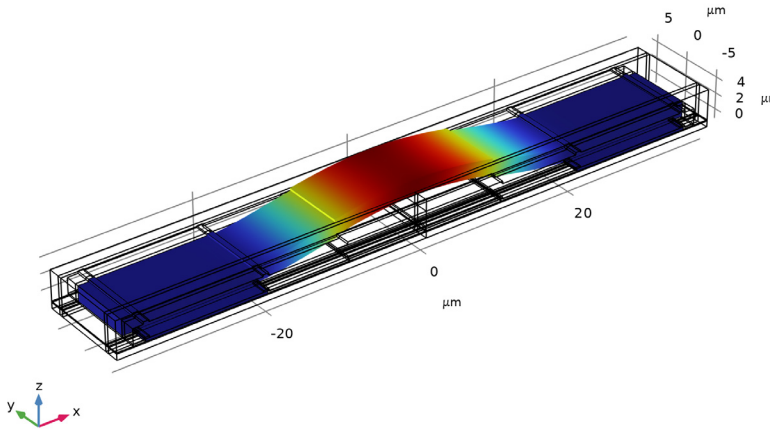

Piezoelectric forces also scale well as the device dimension is reduced (the force produced by a constant applied voltage scales as  $L^1$ ). Furthermore, piezoelectric sensors and actuators are predominantly linear and do not consume DC power in operation. Piezoelectrics are more difficult to integrate with standard semiconductor processes, but significant progress has been made with commercial successes in the market (for example, FBAR filters). Quartz frequency references can be considered the highest volume MEMS component currently in production with more than 1 billion ( $1 \cdot 10^9$ ) devices manufactured per year. Although not traditionally considered to be within the MEMS umbrella (the quartz industry long predates the coining of the term), many of these devices have mm to sub-mm dimensions and are lithographically defined. Furthermore, some quartz products are now being branded as MEMS devices.

The following figure shows the mechanical response of a thickness shear quartz oscillator. Next is a graph showing the effect of a series capacitance ( $C_s$ ) on the frequency response. A series capacitance is frequently used to tune or pull the resonance of quartz oscillators.

freq(86)=5.112E6 Hz

Displacement magnitude (nm)

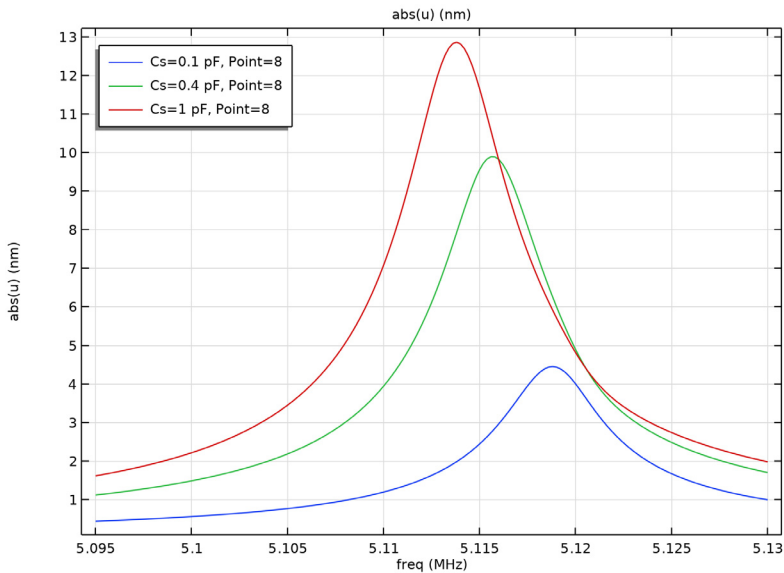
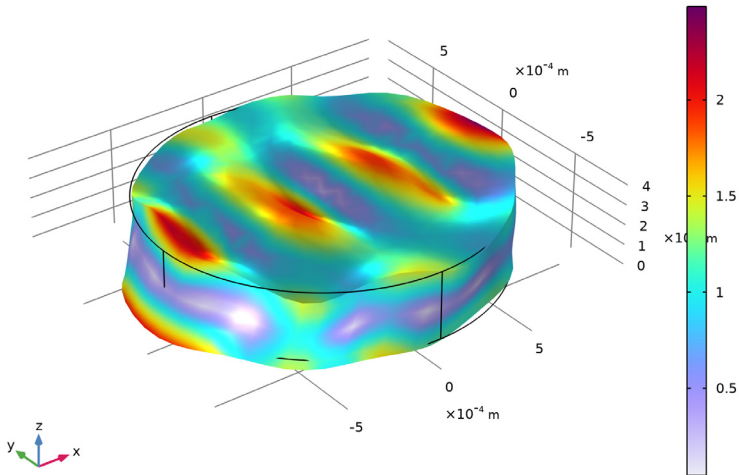

Thermal forces scale as  $L^2$ , assuming that the forces are generated by a fixed temperature change. This scaling is still favorable in comparison to inertial forces, and the thermal time scale also scales well (as  $L^2$ ), making thermal actuators faster

on the microscale (although thermal actuators are typically slower than capacitive or piezoelectric actuators). Thermal actuators are also easy to integrate with semiconductor processes although they usually consume large amounts of power and thus have had a limited commercial applicability. Thermal effects play an important role in the manufacture of many commercial MEMS technologies with thermal stresses in deposited thin films being critical for many applications. The following figure shows the temperature within a displaced, Joule-heated actuator.

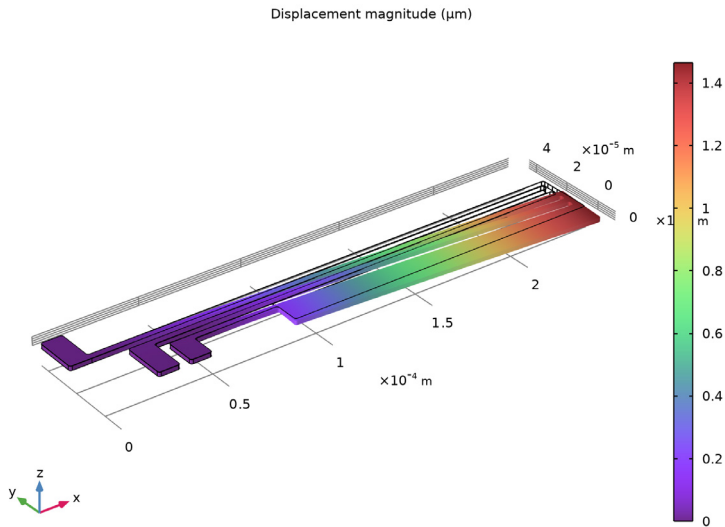

Fluidic MEMS devices, or microfluidic devices, represent an increasingly important area of MEMS. COMSOL provides a separate Microfluidics Module to specifically address these applications. Nonetheless, the MEMS Module includes significant microfluidic functionality for simulating the interaction of MEMS structures with fluids. One area of significant interest is that of thin-film damping. Damping forces scale as  $L^1$  and are often important for MEMS devices, frequently leading to a requirement for vacuum packaging. The figure below shows the pressure on the surface of a simple accelerometer. This pressure results from the compression of the thin layer of rarefied gas between the accelerometer and the package (the package is not shown in the figure).

pA(3)=50 Pa Time=4 ms

Pressure (Pa)

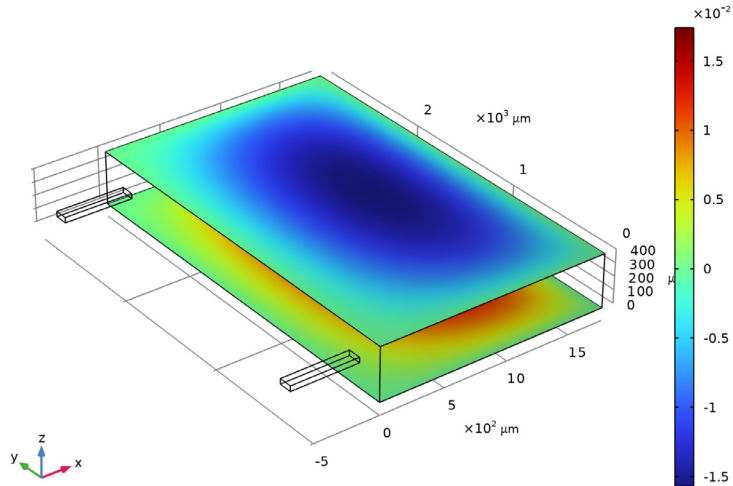

The preceding discussion has focused on the forces available for driving actuators, but scaling is also important for the operation of sensors. Piezoresistive sensors typically produce an output proportional to stress, which for a fixed strain scales independently of device dimension (as  $L^0$ ). The piezoresistive effect refers to the change in a material's conductivity that occurs in response to an applied stress. The ease of integration of small piezoresistors with standard semiconductor processes, along with the reasonably linear response of the sensor, has made this technology particularly important in the pressure sensor industry. The following figure shows the current distribution and the induced voltage in a piezoresistor that senses the deflection of a pressure sensor.

Contour: Electric potential (V) Arrow Surface: Surface current density

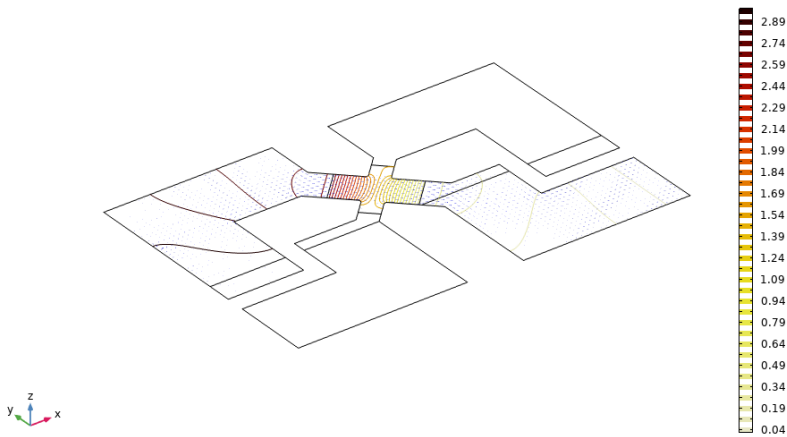

## The MEMS Module Physics Interface Guide

The MEMS physics interfaces are used to simulate MEMS devices. Each physics interface expresses the relevant physical phenomena in the form of sets of partial or ordinary differential equations, together with appropriate boundary and initial conditions. Each feature added to the physics interface represents a term or condition in the underlying equation set. These features are usually associated with a geometric entity within the model, such as a domain, boundary, edge (for 3D components), or point. Figure 1 uses the Micromirror model (found in the MEMS Module application library) to show the Model Builder and the Settings window for the selected Linear Elastic Material 1 feature node. This node adds the equations of structural mechanics to the simulation within the domains selected. Under the Linear Elastic Material section several settings indicate that the Young's modulus, Poisson's ratio, and density are inherited from the material properties assigned to the domain. The material properties can be set up as functions of other dependent variables in the model, such as temperature. The Free and Fixed boundary conditions are also indicated in the model tree. The Free boundary condition is applied by default to all surfaces in the model and allows free motion of the surface. The Fixed boundary condition is used to constrain surfaces that are held in place, for example, by attachment to the wafer handle.

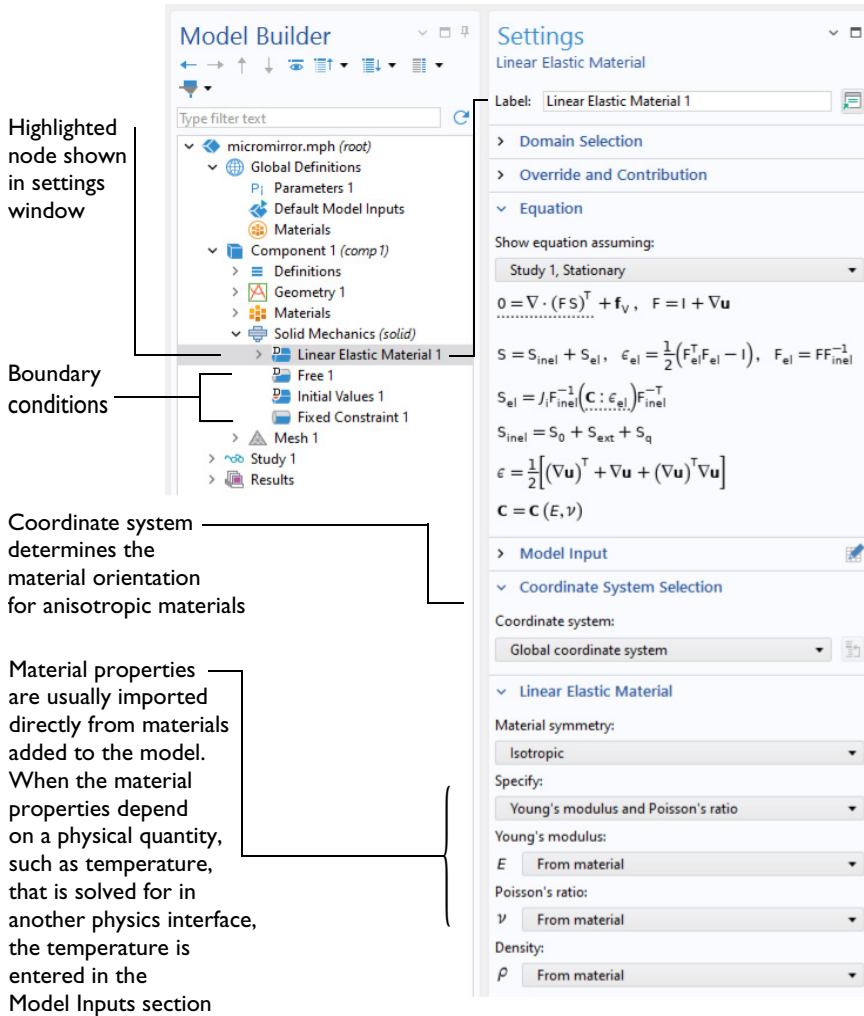

Figure 1: The Model Builder (to the left), and the Settings window for Linear Elastic Material 1 for the selected feature node (to the right). The Equation section in the Settings window shows the model equations. The terms added to the equation system by the feature are underlined with a dotted line. Note that geometric nonlinearity has been disabled in the solver settings to make the equation form simpler.

The MEMS Module includes a number of physics interfaces to enable modeling of different physical situations encountered in microsystem design. When a new model is started, these physics interfaces are selected from the Model Wizard. Figure 2 shows the Model Wizard with the physics interfaces included with the

MEMS Module. Since MEMS is a multidisciplinary industry, the physics interfaces are spread over a number of different areas within COMSOL's supported physics types and correspondingly appear on several branches of the Model Wizard. Also see [Physics Interface Guide by Space Dimension and Preset Study Type](#). Below, a brief overview of each of the MEMS Module physics interfaces is given.

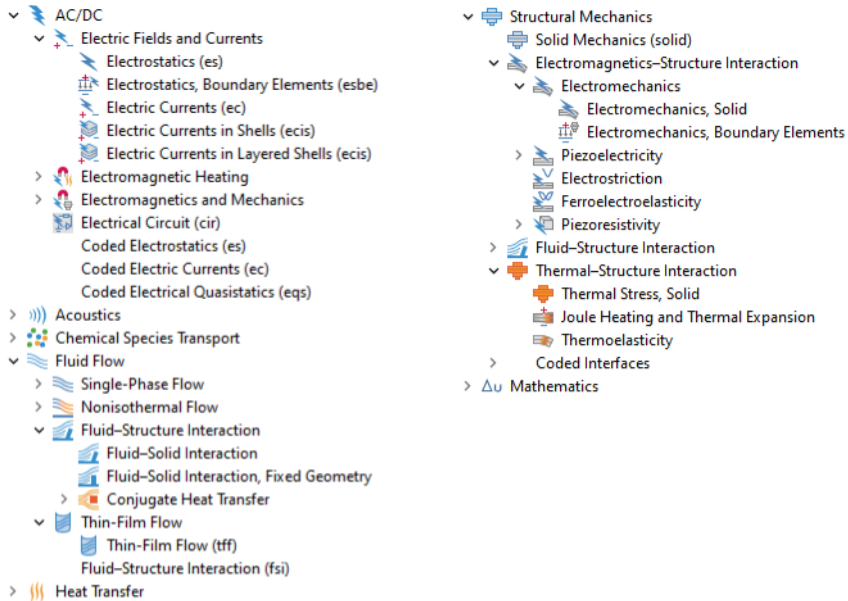

Figure 2: The MEMS Module physics interfaces as displayed in the Model Wizard. Note that this is for 3D components.

## ELECTROSTATICS

The Electrostatics interface (⚡), found under the AC/DC branch in the Model Wizard, solves for the electric potential given the charge distribution in the domain and the voltages applied to boundaries. It is used to model electrostatic devices under static or quasistatic conditions, that is, at frequencies sufficiently low that wave propagation effects can be neglected. A typical application for this physics interface would be computing the low-frequency capacitance of an unbiased MEMS device.

## ELECTRIC CURRENTS

The Electric Currents interface (⚡), found under the AC/DC branch in the Model Wizard, is used to model DC, AC, and transient electric current flow in conductive and capacitive media. The physics interface solves a current

conservation equation for the electric potential. This physics interface could be used to compute the current distribution in interconnect layers.

## ELECTRICAL CIRCUIT

The Electrical Circuit interface () , found under the AC/DC branch in the Model Wizard, has the equations to model electrical circuits with or without connections to a distributed fields model. The physics interface solves for the voltages, currents, and charges associated with the circuit elements. Circuit models can contain passive elements like resistors, capacitors, and inductors as well as active elements such as diodes and transistors. Circuits can be imported from an existing SPICE net list. A typical application of this physics interface would be in evaluating the effect of a series capacitor on a quartz crystal oscillator.

## ELECTROMECHANICS

The Electromechanics predefined multiphysics interface () , found under the Structural Mechanics branch in the Model Wizard, combines the Electrostatics and Solid Mechanics physics interfaces with the Electromechanics multiphysics coupling and the Moving Mesh multiphysics definition to solve the structural equations together with the equations of electrostatics. Electrical forces are added to structures within the model, and isotropic electrostriction can also be included if desired. This multiphysics interface should be used for the modeling of electrostatically actuated MEMS devices, as well as for capacitance-based sensors which detect structural deformation.

## ELECTROMECHANICS, BOUNDARY ELEMENTS





The Electromechanics predefined multiphysics interface () , found under the Structural Mechanics branch in the Model Wizard, combines the Electrostatics, Boundary Elements and Solid Mechanics physics interfaces with the Electromechanics multiphysics coupling. The interface is the same as Electromechanics, except that the boundary element method is used for the electrostatics part of the problem. Moving Mesh is not required when using this approach.

## FLUID-STRUCTURE INTERACTION

The Fluid-Structure Interaction (FSI) interface () , found under the Fluid Flow branch in the Model Wizard, combines fluid flow with solid mechanics to capture the interactions between fluids and solid structures. A Solid Mechanics interface and a Single-Phase Flow interface model the solid and the fluid, respectively. The flow can be either laminar or turbulent (turbulent flow requires the CFD Module, which also allows Two-Phase and Three-Phase Flow interfaces to be coupled to

solid mechanics). The FSI couplings appear on the boundaries between the fluid and the solid. The Fluid-Structure Interaction interface uses an arbitrary Lagrangian-Eulerian (ALE) method to combine the fluid flow formulated using an Eulerian description and a spatial frame with solid mechanics formulated using a Lagrangian description and a material (reference) frame.

## JOULE HEATING AND THERMAL EXPANSION

The Joule Heating and Thermal Expansion interface () combines thermal, electric, and structural multiphysics effects. The predefined coupling adds the electromagnetic losses from the electric field as a heat source. Choosing this option from the Model Wizard adds the Solid Mechanics () , Electric Currents () and Heat Transfer in Solids () interfaces to the model, along with the appropriate couplings for Joule Heating (found under the Multiphysics Branch of the Model Builder ()). The multiphysics interface describes the conduction of electric current in a structure, the subsequent electric heating caused by the ohmic losses in the structure, and the thermal stresses induced by the temperature field. Typical applications include thermal actuators.

## PIEZOELECTRICITY

The Piezoelectricity interface () , found under the Structural Mechanics branch in the Model Wizard, is used when piezoelectric materials are present in a model. The piezoelectric coupling can be specified in stress-charge or strain-charge form. Choosing this option from the Model Wizard adds the Solid Mechanics and the Electrostatics interfaces to the model. A Piezoelectric Material is added by default to all domains in the Solid Mechanics interface and a Charge Conservation, Piezoelectric node is added to the same domains in the Electrostatics interface. These two nodes are coupled by the Piezoelectric Effect multiphysics coupling feature (found under the Multiphysics Branch of the Model Builder).

## PIEZORESISTIVITY

The Piezoresistivity interfaces () , found under the Structural Mechanics branch in the Model Wizard, combine the Solid Mechanics interface (or the Shell interface) with the Electric Currents interface (or the Electric Currents, Single Layer Shell interface) and adds the constitutive relations for piezoresistive materials. Piezoresistive materials can be modeled together with structural and conducting materials. Applications include modeling piezoresistive pressure sensors.

## PYROELECTRICITY

The Pyroelectricity multiphysics interface () combines the Electrostatics and the Heat Transfer physics interfaces with the Pyroelectricity multiphysics coupling. Found under the AC/DC branch in the Model Wizard, the Pyroelectricity interface is used to simulate the electric polarization in solid dielectrics resulting from the variations of temperature.

## PIEZOELECTRICITY AND PYROELECTRICITY

The Piezoelectricity and Pyroelectricity multiphysics interface () combines the Electrostatics, the Heat Transfer, and the Solid Mechanics physics interfaces with the Piezoelectric Effect, the Thermal Expansion, and the Pyroelectricity multiphysics couplings. Found under the Structural Mechanics branch in the Model Wizard, the Piezoelectricity and Pyroelectricity interface is used to simulate the electric polarization in piezoelectric material resulting from the variations of temperature.



## SOLID MECHANICS

The Solid Mechanics interface () defines the quantities and features for stress analysis and general linear and nonlinear solid mechanics, solving for the displacements. The Linear Elastic Material node is the default material model. In addition, the elastic material model can be extended with thermal expansion, viscoelasticity, damping, and initial stress and strain features. The description of elastic materials in the module includes isotropic, orthotropic, and fully anisotropic materials. A number of preset study types are available—see the list in [Physics Interface Guide by Space Dimension and Preset Study Type](#).

## THIN-FILM FLOW

The Thin-Film Flow () interfaces model the flow of liquids or gases confined in a thin layer on a surface. Using equations defined on the surface, these physics interfaces compute the average velocity and pressure in narrow planar structures. In MEMS applications, these physics interfaces are typically used to model thin film damping.

## THERMAL STRESS

The Thermal Stress interface () combines thermal and structural multiphysics effects. The predefined coupling adds the thermal expansion that results from a heat transfer problem to a structure. Choosing this option from the Model Wizard adds the Solid Mechanics () and Heat Transfer in Solids () interfaces to the model as well as features which couple the structural expansion to the temperature distribution in the solid (these features are found under the Multiphysics Branch







of the Model Builder (). A typical application might be to model the deformation of a device caused by a thermal gradient.













## THERMOELASTICITY









The Thermoelasticity predefined multiphysics interface () combines the Solid Mechanics and Heat Transfer in Solids physics interfaces with the Thermal Expansion multiphysics coupling to solve for the displacement of the structure and the temperature deviations and the resulting heat transfer induced by the thermoelastic coupling. Thermoelasticity is an important contribution to the damping of high quality factor MEMS resonators.









## Physics Interface Guide by Space Dimension and Preset Study Type







The table below lists the physics interfaces available specifically with this module in addition to the COMSOL Multiphysics basic license.







PHYSICS INTERFACE	ICON	TAG	SPACE DIMENSION	AVAILABLE STUDY TYPE
 <b>AC/DC</b>				
Electric Currents <sup>1</sup>		ec	all dimensions	stationary; stationary source sweep; frequency domain; time dependent; small signal analysis, frequency domain; eigenfrequency
Electric Currents in Shells		ecis	3D	stationary; frequency domain; time dependent; eigenfrequency
Electric Currents in Layered Shells		ecis	3D	stationary; frequency domain; time dependent; eigenfrequency
Electrical Circuit		cir	Not space dependent	stationary; frequency domain; time dependent; frequency domain; eigenfrequency
Electrostatics <sup>1</sup>		es	all dimensions	stationary; time dependent; stationary source sweep; eigenfrequency; frequency domain; small signal analysis, frequency domain









PHYSICS INTERFACE	ICON	TAG	SPACE DIMENSION	AVAILABLE STUDY TYPE
 <b>Elastic Waves</b>				
Elastic Waves, Time Explicit		elte	3D, 2D, 2D axisymmetric	time dependent
Piezoelectric Waves, Time Explicit		—	3D, 2D, 2D axisymmetric	time dependent
Transport in Solids		ts	all dimensions	stationary; time dependent
 <b>Fluid Flow</b>				
 <b>Single-Phase Flow</b>				
Laminar Flow <sup>1</sup>		spf	3D, 2D, 2D axisymmetric	stationary; time dependent
 <b>Fluid–Structure Interaction</b>				
Fluid–Solid Interaction <sup>2</sup>		—	3D, 2D, 2D axisymmetric	stationary; time dependent
Conjugate Heat Transfer, Fluid–Solid Interaction <sup>2</sup>		—	3D, 2D, 2D axisymmetric	stationary; time dependent;
Fluid–Solid Interaction, Viscoelastic Flow <sup>2,7</sup>		—	3D, 2D, 2D axisymmetric	time dependent; time dependent with phase initialization
Fluid–Solid Interaction, Two-Phase Flow, Phase Field <sup>2,6</sup>		—	3D, 2D, 2D axisymmetric	time dependent; time dependent with phase initialization



PHYSICS INTERFACE	ICON	TAG	SPACE DIMENSION	AVAILABLE STUDY TYPE
Solid–Thin-Film Damping <sup>2</sup>		—	3D, 2D, 2D axisymmetric	stationary; eigenfrequency; time dependent; time dependent, modal; time dependent, modal reduced-order model; frequency domain; frequency domain, modal; frequency domain, modal reduced-order model; time dependent; response spectrum; random vibration (PSD)
Shell–Thin-Film Damping <sup>2,4</sup>		—	3D, 2D axisymmetric	stationary; eigenfrequency; time dependent; time dependent, modal; time dependent, modal reduced-order model; frequency domain; frequency domain, modal; frequency domain, modal reduced-order model; time dependent; response spectrum; random vibration (PSD)
 <b>Thin-Film Flow</b>				
Thin–Film Flow		tff	3D, 2D, 2D axisymmetric	stationary; time dependent; frequency domain; eigenfrequency
Thin–Film Flow, Domain		tff	2D	stationary; time dependent; frequency domain; eigenfrequency
 <b>Electromagnetic Heating</b>				
Joule Heating <sup>1,2</sup>		—	all dimensions	stationary; time dependent; small-signal analysis; frequency domain
Pyroelectricity		—	3D, 2D, 2D axisymmetric	stationary; time dependent

PHYSICS INTERFACE	ICON	TAG	SPACE DIMENSION	AVAILABLE STUDY TYPE
 <b>Structural Mechanics</b>				
Solid Mechanics <sup>1</sup>		solid	3D, 2D, 2D axisymmetric, 1D, 1D axisymmetric	stationary; eigenfrequency; eigenfrequency, prestressed; mode analysis; time dependent; time dependent, modal; time dependent, modal reduced-order model; frequency domain; frequency domain, modal; frequency domain, prestressed; frequency domain, prestressed, modal; frequency domain, modal reduced-order model; frequency domain, AWE reduced-order model; response spectrum; random vibration (PSD); linear buckling
Phase Field Damage <sup>8</sup>		—	3D, 2D, 2D axisymmetric	stationary; time dependent
 <b>Thermal-Structure Interaction</b>				
Thermal Stress, Solid <sup>2</sup>		—	3D, 2D, 2D axisymmetric	stationary; time dependent
Joule Heating and Thermal Expansion <sup>2</sup>		—	3D, 2D, 2D axisymmetric	stationary; time dependent
Thermoelasticity <sup>2</sup>		—	3D, 2D, 2D axisymmetric	eigenfrequency; frequency domain; time dependent
 <b>Electromechanics</b>				
Electromechanics <sup>2</sup>		—	3D, 2D, 2D axisymmetric	stationary; eigenfrequency, prestressed; time dependent; frequency domain, prestressed

PHYSICS INTERFACE		ICON	TAG	SPACE DIMENSION	AVAILABLE STUDY TYPE
	Electromechanics, Shell <sup>2,4,5</sup>			3D, 2D axisymmetric	stationary; eigenfrequency, prestressed; time dependent; frequency domain, prestressed
	Electromechanics, Membrane <sup>2,4,5</sup>			3D, 2D axisymmetric	stationary; eigenfrequency, prestressed; time dependent; frequency domain, prestressed
	Electromechanics, Boundary Elements <sup>2</sup>		—	3D, 2D	stationary; eigenfrequency, prestressed; time dependent; frequency domain, prestressed
<b> Piezoelectricity</b>					
	Piezoelectricity, Solid <sup>2</sup>		—	3D, 2D, 2D axisymmetric	stationary; eigenfrequency; eigenfrequency, prestressed; time dependent; time dependent, modal; frequency domain; frequency domain, modal; frequency domain, prestressed; frequency domain, prestressed, modal; small-signal analysis, frequency domain; linear buckling
	Piezoelectricity, Layered Shell <sup>2,5</sup>		—	3D	stationary; eigenfrequency; time dependent; frequency domain
	Piezoelectricity and Pyroelectricity <sup>2</sup>		—	3D, 2D, 2D axisymmetric	stationary; eigenfrequency; eigenfrequency, prestressed; time dependent; time dependent, modal; frequency domain; frequency domain, modal; frequency domain, prestressed; frequency domain, prestressed, modal; small-signal analysis, frequency domain; linear buckling

PHYSICS INTERFACE	ICON	TAG	SPACE DIMENSION	AVAILABLE STUDY TYPE
 <b>Magnetomechanics</b>				
Piezomagnetism <sup>2,3</sup>		—	3D, 2D, 2D axisymmetric	stationary; eigenfrequency; time dependent; frequency domain; small-signal analysis, frequency domain; eigenfrequency, prestressed; frequency domain, prestressed
Nonlinear Magnetostriction <sup>2,3</sup>		—	3D, 2D, 2D axisymmetric	stationary; eigenfrequency; time dependent; frequency domain; small-signal analysis, frequency domain; eigenfrequency, prestressed; frequency domain, prestressed
Magnetomechanics, Solids <sup>2,3</sup>		—	3D, 2D, 2D axisymmetric	stationary; eigenfrequency; time dependent; frequency domain; small-signal analysis, frequency domain; eigenfrequency, prestressed; frequency domain, prestressed
Magnetomechanics, No Currents, Solids <sup>2,3</sup>		—	3D, 2D, 2D axisymmetric	stationary; eigenfrequency; time dependent; frequency domain; small-signal analysis, frequency domain; eigenfrequency, prestressed; frequency domain, prestressed
Magnetomechanics, Shell <sup>2,3</sup>		—	3D, 2D axisymmetric	stationary; eigenfrequency; time dependent; frequency domain; small-signal analysis, frequency domain; eigenfrequency, prestressed; frequency domain, prestressed

PHYSICS INTERFACE	ICON	TAG	SPACE DIMENSION	AVAILABLE STUDY TYPE
Magnetomechanics, No Currents, Shell <sup>2,3</sup>		—	3D, 2D axisymmetric	stationary; eigenfrequency; time dependent; frequency domain; small-signal analysis, frequency domain; eigenfrequency, prestressed; frequency domain, prestressed
Magnetomechanics, Membrane <sup>2,3</sup>		—	3D, 2D axisymmetric	stationary; eigenfrequency; time dependent; frequency domain; small-signal analysis, frequency domain; eigenfrequency, prestressed; frequency domain, prestressed
Magnetomechanics, No Currents, Membrane <sup>2,3</sup>		—	3D, 2D axisymmetric	stationary; eigenfrequency; time dependent; frequency domain; small-signal analysis, frequency domain; eigenfrequency, prestressed; frequency domain, prestressed
 <b>Electrostriction</b>				
Ferroelectroelasticity <sup>2</sup>		—	3D, 2D, 2D axisymmetric	stationary; time dependent; frequency domain
Electrostriction <sup>2</sup>		—	3D, 2D, 2D axisymmetric	stationary; time dependent; frequency domain
 <b>Piezoresistivity</b>				
Piezoresistivity, Domain Currents <sup>2</sup>		—	3D	stationary; eigenfrequency; time dependent; time dependent, modal; frequency domain; frequency domain, modal; small-signal analysis, frequency domain; eigenfrequency, prestressed; frequency domain, prestressed

PHYSICS INTERFACE	ICON	TAG	SPACE DIMENSION	AVAILABLE STUDY TYPE
Piezoresistivity, Boundary Currents <sup>2</sup>		—	3D	stationary; eigenfrequency; time dependent; time dependent, modal; frequency domain; frequency domain, modal; small-signal analysis, frequency domain; eigenfrequency, prestressed; frequency domain, prestressed
Piezoresistivity, Shell <sup>2,4</sup>		—	3D	stationary; time dependent; time dependent, modal; frequency domain; frequency domain, modal; small-signal analysis, frequency domain; eigenfrequency, prestressed; frequency domain, prestressed
Piezoresistivity, Layered Shell <sup>2,5</sup>		—	3D	stationary; time dependent; time dependent, modal; frequency domain; frequency domain, modal; small-signal analysis, frequency domain; eigenfrequency, prestressed; frequency domain, prestressed

<sup>1</sup> This physics interface is included with the core COMSOL package but has added functionality for this module.

<sup>2</sup> This physics interface is a predefined multiphysics coupling that automatically adds all the physics interfaces and coupling features required.

<sup>3</sup> Requires the addition of the AC/DC Module.

<sup>4</sup> Requires the addition of the Structural Mechanics Module.

<sup>5</sup> Requires the addition of the Composite Materials Module.

<sup>6</sup> Requires the addition of the CFD Module, or the Polymer Flow Module or the Microfluidics Module.

<sup>7</sup> Requires the addition of the Polymer Flow Module.

<sup>8</sup> Requires the addition of the Nonlinear Structural Materials Module.

# Tutorial Model: Modeling a Capacitive Pressure Sensor

This tutorial analyzes a hypothetical absolute pressure sensor used as an example in the book *Practical MEMS*, by V. Kaajakari (V. Kaajakari, *Practical MEMS*, Small Gear Publishing, Las Vegas, pp. 207–209, 2009). Initially the sensitivity of the device is assessed under ideal operating conditions. Then the effect of packaging induced stress is analyzed, both in terms of the device sensitivity to pressure and an induced sensitivity to temperature.

The device geometry is shown in [Figure 3](#). The pressure sensor is part of a silicon die that has been bonded to a metal plate at 70°C. The COMSOL Multiphysics model takes advantage of the symmetry in the geometry and models only a single quadrant of the device.

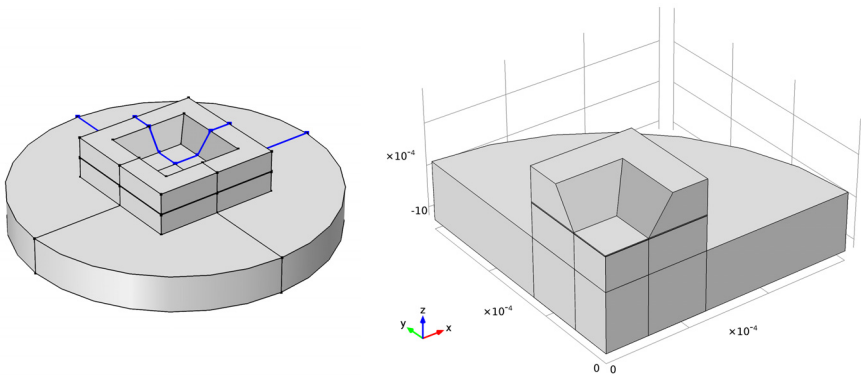

Figure 3: The model geometry. Left: The symmetric device geometry, with the edges of one quadrant highlighted in blue, showing the symmetry planes. Right: In COMSOL Multiphysics only the highlighted quadrant is modeled, and the symmetry boundary condition is used on the cross section walls.

A detailed 2D section through the functional part of the device is shown in [Figure 4](#). A thin membrane is held at a fixed potential of 1 V. The membrane is separated from a ground plane by a chamber sealed under high vacuum. The sides of the chamber are insulating to prevent a connection between the membrane and the ground plane (for simplicity the insulating layer is not modeled explicitly in the COMSOL Multiphysics model — this approximation will have little effect on the results of the study).

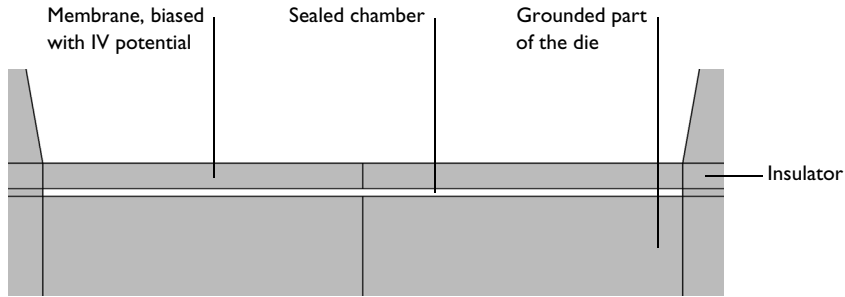

Figure 4: Cross section through the device showing the capacitor. The vertical axis has been expanded to emphasize the gap.

Pressure on the membrane from ambient gas causes the membrane to deflect. The thickness of the gap now varies across the membrane and its capacitance to ground therefore changes. This capacitance is then monitored by an interfacing circuit, such as the switched capacitor amplifier circuit discussed in the case study in *Practical MEMS*.

Thermal stresses are induced in the structure as a result of the thermal conductivity mismatch between the silicon die and the metal plate, and the elevated temperature used for the bonding process (assumed to be 70°C, compared to an operating temperature of 20°C). These stresses change the deformation of the diaphragm in response to applied pressures and alter the response of the sensor. In addition, since the stresses are temperature dependent, they introduce an undesired temperature dependence to the device output.

Initially the sensor is analyzed in the case where there are no packaging stresses. Then the effect of the packaging stress is considered. First, the device response at fixed temperature is evaluated with the additional packaging stress. Finally the temperature dependence of the device response at a fixed applied pressure is assessed.



## Model Wizard

---





**Note:** These instructions are for the user interface on Windows but apply, with minor differences, also to Linux and Mac.

- I To start the software, double-click the COMSOL icon on the desktop. When the software opens, you can choose to use the Model Wizard to create a new

COMSOL Multiphysics model or Blank Model to create one manually. For this tutorial, click the Model Wizard button.

If COMSOL Multiphysics is already open, you can start the Model Wizard by selecting New  from the File menu and then click Model Wizard .

The Model Wizard guides you through the first steps of setting up a model. The next window lets you select the dimension of the modeling space.

- 2 In the Select Space Dimension window click the 3D button .
- 3 In the Select Physics tree, expand the Structural Mechanics node, expand the Electromagnetics-Structure Interaction subnode, expand the Electromechanics subnode, then click Electromechanics .
- 4 Click the Add button, observe that the “Added physics interfaces” pane is populated with physics interfaces and multiphysics couplings, and then click Study .
- 5 In the tree under General Studies, click Stationary .
- 6 Click Done .

## Geometry I

---

The geometry is imported from an external file. Since the structure is symmetric, only a quarter of the physical geometry is required.

### *Import I*



- 1 In the Geometry toolbar, click Insert Sequence .

**Note:** On Linux and Mac, the toolbar refers to the specific set of controls near the top of the Desktop.

- 2 Browse to and then open the file `capacitive_pressure_sensor_geom_sequence.mph` in the application library folder `MEMS_Module\Sensors`.

**Note:** The location of the application library root folder varies based on your installation. For example, if the installation is on your hard drive, the file path might be similar to

`C:\Program Files\COMSOL\COMSOL64\Multiphysics\applications\.`

- 3 Click Build All .
- 4 Click the Zoom Extents button  at the top of the Graphics window.

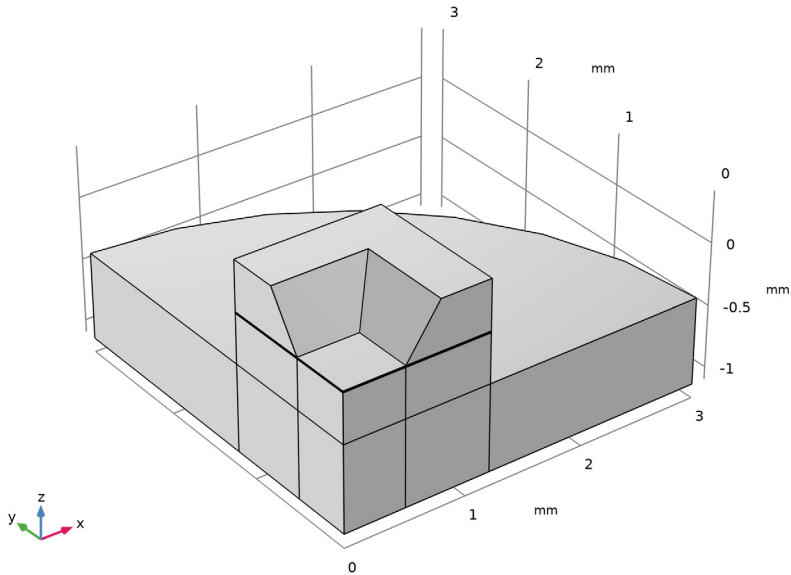

## Global Definitions

---

### Parameters

- 1 In the Home toolbar click Parameters  $P_i$  and choose Parameters 1  $P_i$ .
- 2 In the Settings window under Parameters, enter the following settings in the Parameters table:

NAME	EXPRESSION	DESCRIPTION
$p_0$	20 [kPa]	Pressure
$T_0$	20 [degC]	Operating Temperature
$T_{ref}$	70 [degC]	Die Bonding Temperature



**Note:** SI units or their multiples, such as Pa, kPa, and so on, or even some non-SI units, such as degrees Celsius (as degC), can be enclosed by square brackets to be entered into the COMSOL Desktop graphical user interface for specifying the unit of the preceding value. See the section “Using Units” in the *COMSOL Multiphysics Reference Manual* for a detailed list of supported units.



## Definitions

---



Next add a nonlocal coupling to compute a derived global quantity from the model. These operators can be convenient for postprocessing and for setting up the model, for example to include integral quantities in the equation system. Here an average operator is added so that the average displacement of the diaphragm can be computed and a point integration is used to make available the displacement of the centerpoint of the diaphragm.

### *Average 1*

- 1 In the Definitions toolbar click Nonlocal Couplings  and choose Average  .
- 2 In the Settings window for Average locate the Source Selection section. From the Geometric entity level list, choose Boundary.
- 3 Select Boundary 12.

**Note:** There are several methods to select a geometric entity. To select, for example, a boundary, place the cursor over the boundary in the graphics window. If the required boundary is not highlighted in red then rotate the scroll wheel of the mouse until the boundary is highlighted, then click to select it (the up and down arrow keys can also be used instead of the scroll wheel). Alternatively, click the Paste Selection button  . In the Paste Selection dialog, in the Selection text field, type 12 (the boundary number) and then click OK. Another method is to use the Selection list  to display a list of the available boundary numbers (available from the Home > Windows menu if you are using windows, or from the Windows menu on other platforms). Boundaries are added to the selection by first clicking on the boundary and then clicking Add to Selection  . To add several boundaries, hold the Ctrl key down when clicking.

### *Integration 1*

- 1 In the Definitions toolbar click Nonlocal Couplings  and choose Integration  .
- 2 In the Settings window for Integration locate the Source Selection section. From the Geometric entity level list, choose Point.
- 3 Select Point 4 only.

Next, define selections to simplify the setup of materials and physics features.

### *Explicit 1*

- 1 In the Definitions toolbar click Explicit  .

- 2 Select Domain 3 and 4 only.
- 3 In the Label text field enter `Electrostatics`.

## Solid Mechanics

---



Next the physics feature settings are added to the model. These include the pressure forces acting on the sensor, the applied sense voltage, and other appropriate boundary conditions.

First choose the domains for the Solid Mechanics interface.



- 1 In the Model Builder window, under Component 1 (comp1) click Solid Mechanics (solid) .
- 2 In the Settings window for Solid Mechanics, locate the Domain Selection section.
- 3 From the Selection list, choose Linear Elastic. (This selection is defined in the Geometry sequence.)

Apply the structural symmetry boundary condition on the symmetry boundaries.

### *Symmetry 1*

- 1 In the Physics toolbar, click Boundaries  and choose Symmetry .
- 2 In the Settings window for Symmetry locate the Boundary Selection section. From the Selection list, choose XZ Symmetry Plane.



### *Symmetry 2*

- 1 In the Physics toolbar, click Boundaries  and choose Symmetry .
- 2 In the Settings window for Symmetry locate the Boundary Selection section. From the Selection list, choose YZ Symmetry Plane.

**Note:** The electrical symmetry boundary condition (the Zero Charge feature) is applied by default.

The motion of the structure is constrained in most directions by the structural symmetry boundary conditions. However, the whole device can still slide up and down the z-axis. Apply a point constraint to prevent this.



### *Prescribed Displacement 1*

- 1 In the Physics toolbar click Points  and choose Prescribed Displacement .
- 2 Select Point 44 only.

- 3 In the Settings window for Prescribed Displacement locate the Prescribed Displacement section. Select the Prescribed in z direction checkbox, leaving the input field at the default value of 0.

Apply a boundary load to represent the pressure acting on the top surface of the diaphragm.

#### *Boundary Load 1*



- 1 In the Physics toolbar click Boundaries  and choose Boundary Load .
- 2 Select Boundary 13 only.
- 3 In the Settings window for Boundary Load locate the Force section.
  - From the Load type list, choose Pressure.
  - In the  $p$  text field, enter  $p_0$ .

## Definitions



---

Moving mesh conditions must be applied to the deforming air domain.

#### *Deforming Domain 1*

- 1 In the Model Builder window, expand the Component 1 (comp1) > Definitions > Moving Mesh node , then click Deforming Domain 1 .
- 2 In the Settings window for Deforming Domain, locate the Domain Selection section. From the Selection list, choose Cavity. (This selection is also defined in the Geometry sequence.)

#### *Symmetry 1*

- 1 In the Model Builder window, under the Component 1 (comp1) > Definitions > Moving Mesh node , click Symmetry/Roller 1 .
- 2 Select Boundaries 7 and 8 only.

This allows the mesh to move in the  $z$  direction.

## Electrostatics

---

Add terminal and ground features to the model to apply boundary conditions for the electrostatics parts of the model.

- 1 In the Model Builder window, under Component 1 (comp1) click Electrostatics (es) .

- 2 In the Settings window for Electrostatics, locate the Domain Selection section. From the Selection list, choose Electrostatics.



### *Charge Conservation in Solids I*

In the Model Builder window, Under Component 1 (comp1) > Electrostatics (es) right-click Charge Conservation in Solids I and choose Delete.



With the assumption that the silicon membrane is a good conductor, use the Domain Terminal feature to set a bias voltage on the domain.

Note: The Domain Terminal feature will be very handy for a conducting domain with a complex shape and many exterior boundaries – instead of selecting all the boundaries to set up the Ground, Terminal, or Electric Potential boundary condition, we only need to select the domain to specify the Domain Terminal with the same effect. In addition, the computation load is reduced, because the electrostatic degrees of freedom within the Domain Terminal do not need to be solved for.

### *Terminal I*

- 1 In the Physics toolbar click Domains  and choose Terminal .
- 2 Select Domain 4 only.
- 3 In the Settings window for Terminal, locate the Terminal section. From the Terminal type list, choose Voltage.  
The default value of 1 V is fine in this instance.

### *Ground I*

- 1 In the Physics toolbar click Boundaries  and choose Ground .
- 2 Select Boundary 9 only.

## **Materials**

---

The pressure sensor consists of a silicon die with an enclosed cavity. The pressure sensor is bonded onto a cylindrical steel plate during the packaging process.

COMSOL Multiphysics includes a Material Library with many predefined material properties. A predefined material is used for the steel plate, but the silicon is set up as a user-defined material, as for this model isotropic material parameters are used to enable direct comparison with the results in *Practical MEMS*. The cavity also needs ‘material’ properties (to define the relative permittivity) and a user-defined material is used to set the relative permittivity to 1 in this region.

## Material 1





- 1 In the Materials toolbar click Blank Material .
- 2 In the Settings window for Material locate the Material Contents section. In the table, enter the following settings:

PROPERTY	NAME	VALUE
Relative permittivity	epsilon.r...	11.7
Young's modulus	E	170[GPa]
Poisson's ratio	nu	0.06
Density	rho	2330

- 3 In the Label text field enter Silicon.

By default the first material is applied to all domains. Some of these selections will be overridden as other materials are added.

## Steel AISI 4340 (mat 2)



- 1 In the Material toolbar click Add Material .
- 2 Go to the Add Material window. Click to expand the tree node Built-In; then select Steel AISI 4340 .
- 3 Click + Add to Component. Then click Add Material  in the Material toolbar to close the Add Material window.
- 4 In the Model Builder window click Steel AISI 4340 .
- 5 In the Settings window for Material locate the Geometric Entity Selection section. From the Selection list, choose Steel Base.

## Mesh 1

---

Next set up a structured mesh to solve the problem on.

### Mapped 1

- 1 In the Model Builder window, under Component 1 (comp1) right-click Mesh 1  and choose Boundary Generator > Mapped .
- 2 Select Boundaries 3, 16, and 32 only.

### Size 1



Set a maximum element size on the sensor diaphragm.

- 1 Right-click Mapped 1  and choose Size .

- 2 In the Settings window for Size locate the Element Size section. Click the Custom button.
- 3 Locate the Element Size Parameters section. Select the Maximum element size checkbox. In the associated text field, enter 50[um].
- 4 Locate the Geometric Entity Selection section. The boundaries 3, 16, and 32 are preselected. Change the selection to Boundary 3 only by clicking on the unwanted number and then pressing the Delete key on the keyboard(16, and then 32).
- 5 Click the Build All button  .

Sweep the surface mesh through the structure.

*Swept 1*

- 1 Right-click Mesh 1  and choose Swept .
- 2 Click Build All  .

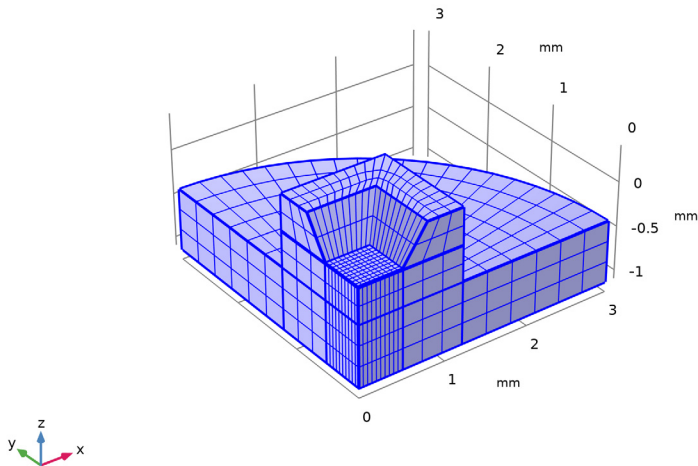





## Study 1

---

Set up a study that sweeps over a range of applied pressures, so that the response of the sensor can be assessed.



### Step 1: Stationary

- 1 In the Model Builder window, expand the Study 1 node , then click Step 1: Stationary .
- 2 In the Settings window for Stationary, click to expand the Study Extensions section. Select the Auxiliary sweep checkbox.
- 3 Click Add .  
The continuation parameter  $p_0$ (Pressure) is added by default. This is the correct parameter to sweep over.
- 4 Click the Range button . Go to the Range dialog.
  - In the Start text field, enter 0.
  - In the Step text field, enter 5000.
  - In the Stop text field, enter 25000.
- 5 Click the Add button.
- 6 In the Home toolbar click Compute .



## Results

---



### Displacement (solid)

- 1 In the Model Builder window, under Results  click Displacement (solid) . Much of the structure has essentially zero movement in this initial study. To facilitate results analysis, add a selection to the solution, so that only the domains of interest are displayed in the plots.

### Datasets



In the Model Builder window, expand the Results > Datasets node , then click Study 1/Solution 1 (sol1) .

### Selection

- 1 In the Results toolbar, click Attributes  and choose Selection .
- 2 In the Settings window for Selection, locate the Geometric Entity Selection section. From the Geometric entity level list, choose Domain.

- 3 From the Selection list, choose Electrostatics.
- 4 Select the Propagate to lower dimensions checkbox.

### Displacement (solid)

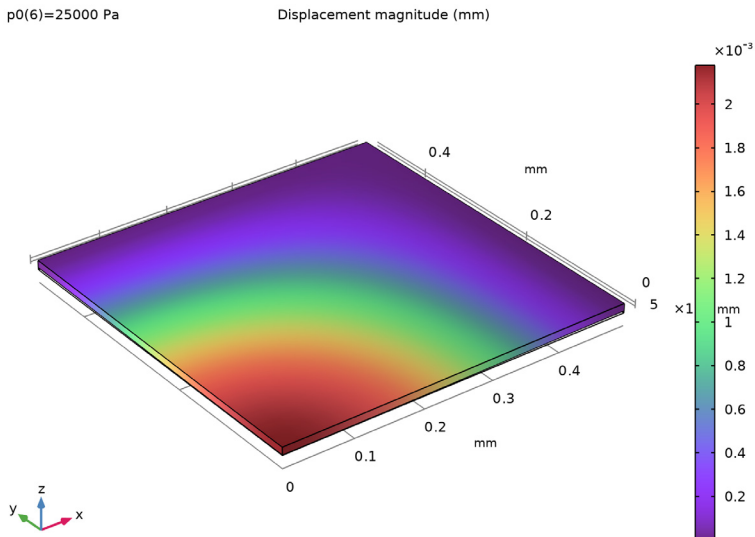

- 1 In the Model Builder tree click the Displacement (solid)  node.
- 2 Click the Zoom Extents button  at the top of the Graphics window.



The plot now shows the displacement of the diaphragm only, which, as expected, is maximum in the center of the sensor.



Next, plot the electric potential in an  $xy$ -oriented plane between the sensor diaphragm and the ground plane.

### Electric Potential (es)

- 1 In the Model Builder window, expand the Results > Electric Potential (es) node , then click Multislice 1 .
- 2 In the Settings window for Multislice, locate the Multiplane Data section.
  - Find the x-planes subsection. In the Planes text field, type 0.
  - Find the y-planes subsection. In the Planes text field, type 0.
  - Find the z-planes subsection. From the Entry method list, choose Coordinates.
  - In the Coordinates text field, type -0.0023[mm].

- 3 Click to expand the Range section. Select the Manual color range checkbox.
  - In the Minimum text field, type 0.
  - In the Maximum text field, type 1.

*Selection 1*

- 1 Right-click Results > Electric Potential (es) > Multislice 1  and choose Selection .
- 2 In the Settings window for Selection, locate the Selection section. From the Selection list, choose Cavity.
- 3 On the Electric Potential (es) toolbar, click the Plot button .

p0(6)=25000 Pa

Multislice: Electric potential (V)

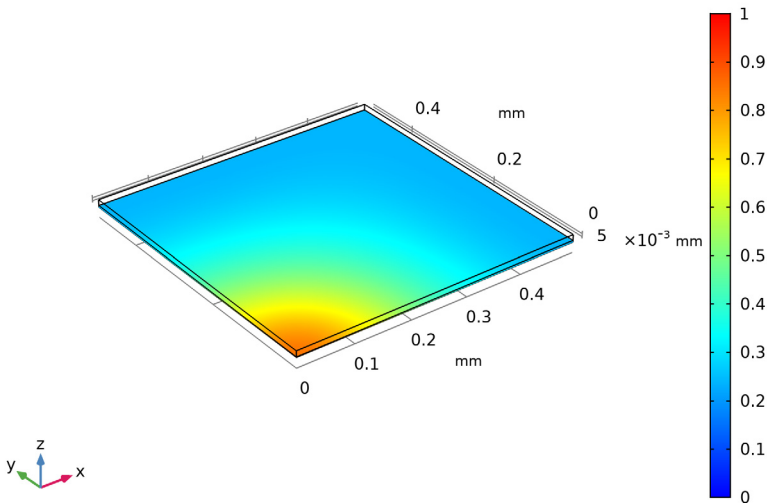

Due to the deformation of the diaphragm the potential is nonuniformly distributed in the plane, which cuts through the cavity at a constant height.

Next, the deformation of the diaphragm is plotted as a function of the pressure difference across it. Both the average and the maximum displacements are plotted.

*1D Plot Group 5*

- 1 In the Home toolbar click Add Plot Group  and choose 1D Plot Group .
- 2 On the 1D Plot Group 5 toolbar click Global .

## Global 1

Use the point integration and surface average operators defined earlier to evaluate the displacement at the midpoint of the membrane and the average displacement.

- 1 In the Settings window for Global locate the y-Axis Data section. In the table, enter the following settings:

EXPRESSION	UNIT	DESCRIPTION
intop1(w)	um	Maximum Displacement
aveop1(w)	um	Average Displacement

## 1D Plot Group 5

- 1 In the Model Builder window click 1D Plot Group 5 .
- 2 In the Settings window for 1D Plot Group 5, click to expand the Title section.
  - From the Title type list, choose Manual.
  - In the Title text field, enter Diaphragm Displacement.
- 3 Locate the Plot Settings section.
  - Select the x-axis label checkbox. In the x-axis label text field, enter Pressure (Pa).
  - Select the y-axis label checkbox. In the y-axis label text field, enter Displacement ( $\mu$  m).
- 4 Click to expand the Legend section. From the Position list, choose Lower left.
- 5 In the Label text field enter Diaphragm Displacement vs Pressure.

6 On the Diaphragm Displacement vs Pressure toolbar, click Plot  .

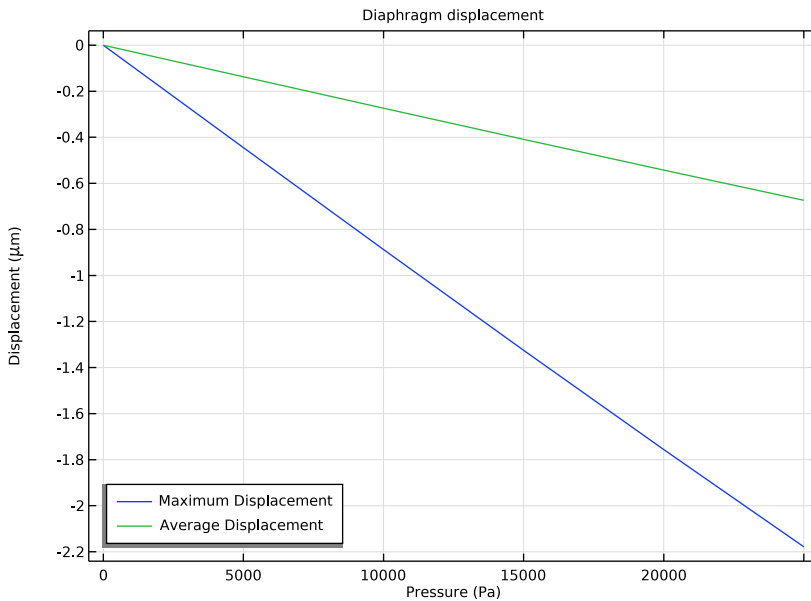

At an applied pressure of 10 kPa the diaphragm displacement in the center is 0.89  $\mu\text{m}$ . The average displacement of the diaphragm is 0.27  $\mu\text{m}$ . These values are in good agreement with the approximate model given in *Practical MEMS* (maximum displacement 0.93  $\mu\text{m}$ , average displacement 0.27  $\mu\text{m}$ ).

Now plot the sensor capacitance as a function of the applied pressure. If the switched capacitor amplifier described in *Practical MEMS* is used to produce the output, the sensor output or transfer function is directly proportional to the change in capacitance.

### 1D Plot Group 6

- 1 In the Home toolbar, click Add Plot Group  and choose 1D Plot Group .
- 2 On the 1D Plot Group 6 toolbar click Global .

Since the terminal boundary condition was used for the underside of the diaphragm, COMSOL Multiphysics automatically computes its capacitance with respect to ground. The value of the capacitance is available as a variable in result analysis.



- 3 In the Settings window for Global, click Replace Expression  in the upper-right corner of the y-Axis Data section. From the menu, navigate to

Component 1 > Electrostatics > Terminals > es.C11 - Maxwell capacitance - F;  
then double click to choose the item.

Next, compare the computed capacitance with the small displacement,  
linearized analytic expression derived in *Practical MEMS*.

- 4 Locate the y-Axis Data section. In the table, change the unit of the first row to pF and enter the second row, as shown below:

EXPRESSION	UNIT	DESCRIPTION
es.C11	pF	Capacitance
$0.738[\text{pF}](1+8.87\text{e-}6[1/\text{Pa}]^*\text{p}0)$	pF	Linearized Analytic Capacitance

- 5 In the Model Builder window click 1D Plot Group 6 .
- 6 In the Settings window for 1D Plot Group locate the Title section.
- From the Title type list, choose Manual.
  - In the Title text area, enter Model Capacitance vs Pressure.
- 7 Locate the Plot Settings section.
- Select the x-axis label checkbox. In the x-axis label text field, enter Pressure (Pa).
  - Select the y-axis label checkbox. In the y-axis label text field, enter Capacitance (pF).
- 8 Locate the Legend section. From the Position list, choose Upper left.
- 9 In the Label text field enter Model Capacitance vs Pressure.
- 10 Click Plot .

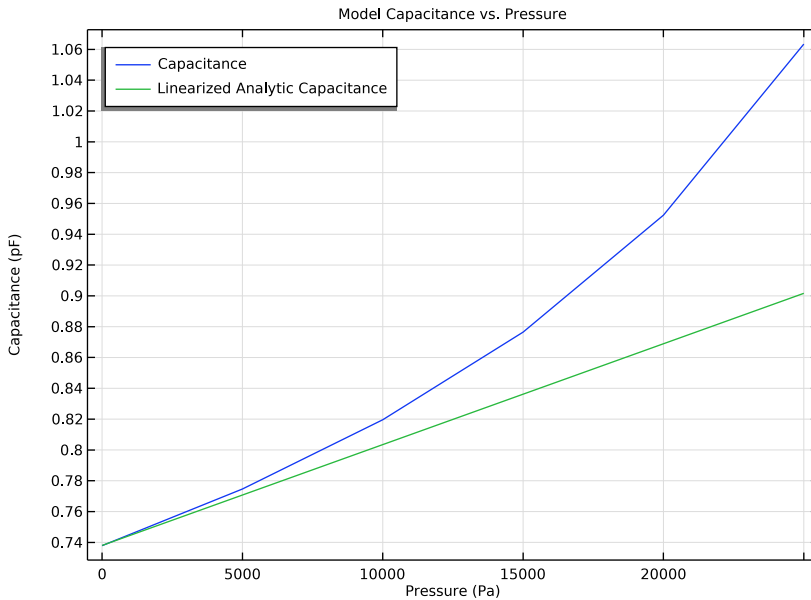



The capacitance of the sensor increases with applied pressure. The gradient of the curve plotted gives a useful measure of the response of the device. At the origin the response of the model ( $1/4$  of the whole sensor) is  $7.3 \times 10^{-6}$  pF/Pa, compared to the simple analytical response of  $6.5 \times 10^{-6}$  pF/Pa. The response for the whole sensor is therefore  $29 \times 10^{-6}$  pF/Pa compared to the analytic value of  $26 \times 10^{-6}$  pF/Pa. With the measurement circuit proposed in *Practical MEMS* this corresponds to a sensor transfer function of  $29 \mu\text{V}/\text{Pa}$  for the COMSOL Multiphysics model and  $26 \mu\text{V}/\text{Pa}$  for the simple analytic model. The response is nonlinear, so that at 20 kPa the model output is  $14 \times 10^{-6}$  pF/Pa (device output 57 pF/Pa).





Next, add thermal expansion to the model, to assess the effects of packaging stresses on the device performance.

## Solid Mechanics

---

In the Physics toolbar, click Electrostatics (es)  (not the upper part where this icon shows but the lower part where the text “Electrostatics” shows with a downward facing black triangle icon) and choose Solid Mechanics (solid) .

## Thermal Expansion I

- 1 In the Model Builder window, expand Solid Mechanics (solid) , and then click Linear Elastic Material 1 . In the Physics toolbar click Attributes  and choose Thermal Expansion .

The model temperature should be set to the previously defined room temperature parameter,  $T_0$ .

- 2 In the Settings window for Thermal Expansion locate the Model Inputs section to choose the “User defined” option for the Temperature list. In the  $T$  text field, enter  $T_0$ .

The reference temperature indicates the temperature at which the structure had no thermal strains. In this case, we set it to the previously defined parameter,  $T_{ref}$ .  $T_{ref}$  represents the temperature at which the silicon die was bonded to the metal carrier plate.

- 3 Choose the “User defined” option for the Volume reference temperature list. In the  $T_{ref}$  text field, enter  $T_{ref}$ .



## Materials

---

The user-defined properties added previously for silicon did not include its thermal expansivity, so this must be added.

### Silicon

COMSOL Multiphysics shows a warning in the material properties settings to indicate a missing property.

- 1 In the Model Builder window, under Component 1 (comp1) > Materials  click Silicon .
- 2 In the Settings window for Material locate the Material Contents section.
- 3 In the table, add a value for the thermal expansion coefficient of silicon to the appropriate row:



PROPERTY	NAME	VALUE
Coefficient of thermal expansion	alpha...	2.6e-6

## Study 2



---

Add a new study to compute the system response including thermal expansion effects.

### Add Study

- 1 In the Home toolbar, click Add Study  to open the Add Study window.
- 2 Go to the Add Study window. In the tree under General Studies, click Stationary .
- 3 Click + Add Study. Then click Add Study  in the Home toolbar to close the Add Study window.

### Step 1: Stationary



- 1 In the Settings window for Stationary, locate the Study Extensions section. Select the Auxiliary sweep checkbox.
- 2 Click Add .  
The continuation parameter p0 (Pressure) is added by default. This is the correct parameter to sweep over.
- 3 Click Range . Go to the Range dialog.
  - In the Start text field, enter 0.
  - In the Step text field, enter 5000.
  - In the Stop text field, enter 25000.
- 4 Click the Add button.
- 5 In the Home toolbar click Compute .

## Results



---

Create a mirrored dataset to visualize a cross section of the device.

### Datasets

- 1 In the Results toolbar click More Datasets  and choose Mirror 3D .
- 2 In the Settings window for Mirror 3D locate the Data section. From the Dataset list, choose Study 2/Solution 2.
- 3 Leave the plane as the default y-z plane.

### Displacement (solid) 1

- 1 In the Model Builder window, under Results right-click Displacement (solid)  and choose Duplicate .
- 2 In the Settings window for 3D Plot Group locate the Data section. From the Dataset list, choose Mirror 3D 1.
- 3 Click the Plot button .

Notice that the entire structure now has nonzero movements at room temperature, as a result of thermal stress.

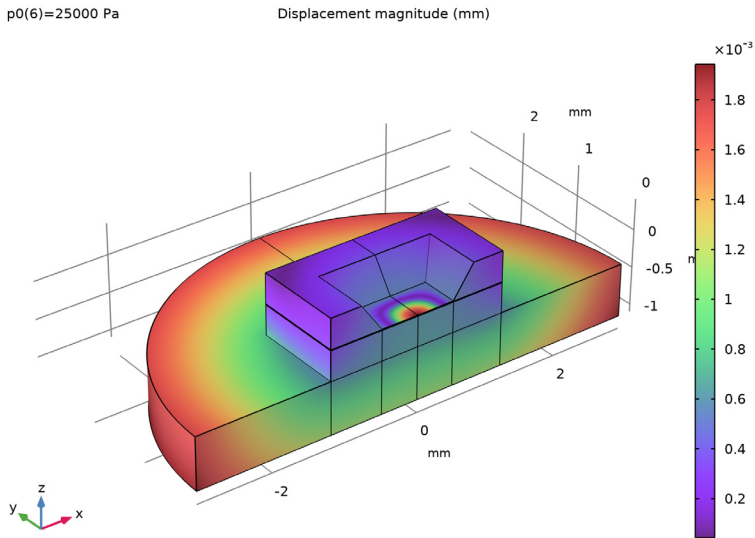

Now look at the effect of the thermal stress on the response of the sensor. Add an additional global node to the previously defined plot. This separate node can point to a different dataset, creating a plot of the displacement of the thermally stressed device alongside the unstressed plot.

### Diaphragm Displacement vs Pressure

- 1 In the Model Builder window, under Results > Diaphragm Displacement vs Pressure ~ right-click Global 1 and choose Duplicate.
- 2 In the Settings window for Global locate the Data section. From the Dataset list, choose Study 2/Solution 2.
- 3 Locate the y-Axis Data section. In the table, enter the following settings for the first row and remove the 2nd row (aveop1):

EXPRESSION	UNIT	DESCRIPTION
intop1(w)	um	Maximum Displacement with Package Stress

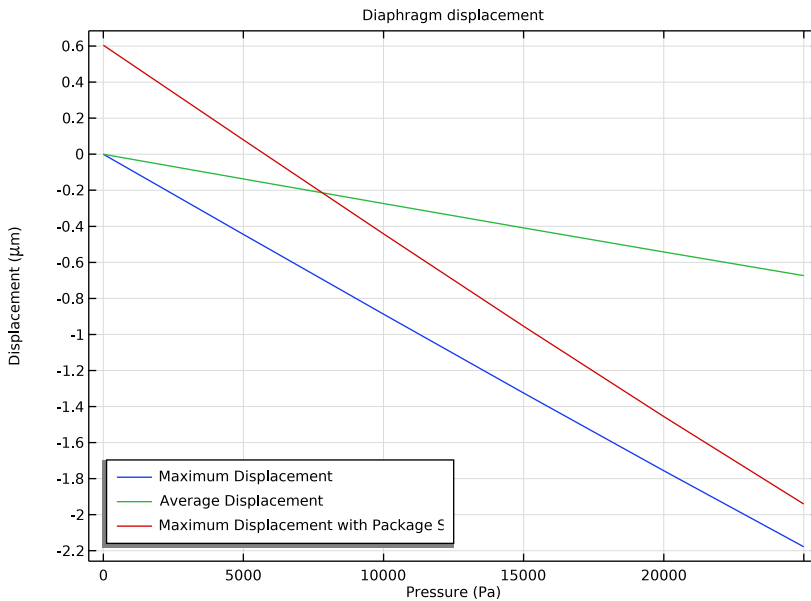

4 Click the Plot button .



The maximum displacement of the membrane is now nonzero at zero applied pressure, as a result of the packaging stress. The gradient of the displacement-pressure line has also changed.

### Model Capacitance vs Pressure

Now add the thermally stressed results to the Capacitance vs Pressure plot.

- 1 Click on the Model Capacitance vs Pressure node . On the Model Capacitance vs Pressure toolbar click Global .
- 2 In the Settings window for Global locate the Data section. From the Dataset list, choose Study 2/Solution 2.
- 3 Click Replace Expression  in the upper-right corner of the y-Axis Data section. From the menu, navigate to Component 1 > Electrostatics > Terminals > es.C11 - Maxwell capacitance - F; then double click to select the item.
- 4 Locate the y-Axis Data section. In the table, modify the first row to match the following settings (Note the unit is changed to pF to match the previous Global plot):

EXPRESSION	UNIT	DESCRIPTION
es.C11	pF	Capacitance with Package Stress

5 Click the Plot button  .

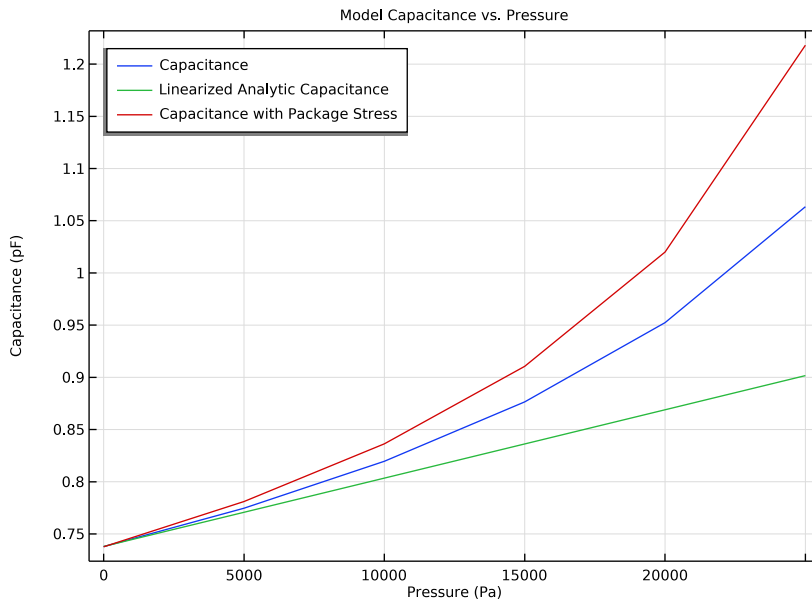



The packaging stress causes a significant change in the response of the device. At zero applied pressure the sensitivity of the COMSOL Multiphysics model has increased to  $10 \times 10^{-6}$  pF/Pa ( $40 \times 10^{-6}$  pF/Pa for the entire device). Compare to the unstressed value of  $7.3 \times 10^{-6}$  pF/Pa ( $29 \times 10^{-6}$  pF/Pa for the entire device). The effect is even more pronounced at a pressure of 20 kPa, where the model that includes thermal stresses shows a pressure sensitivity of  $25 \times 10^{-6}$  pF/Pa (100 pF/Pa for the entire device), compared to the unstressed pressure sensitivity of  $14 \times 10^{-6}$  pF/Pa (sensor output 57 pF/Pa).

It may be possible to calibrate the device to remove the effect of the packaging strains. However, the addition of the thermal stresses to the system has created an additional issue, since the response of the sensor has now become temperature dependent - due to the temperature sensitivity of the thermal strains. This effect is assessed in the final study.

## Study 3

---

### Add Study

- 1 In the Home toolbar, click the Add Study  button to open the Add study window.
- 2 Go to the Add Study window. In the tree, under General Studies select Stationary .
- 3 Click + Add Study. Then click the Add Study  in the toolbar again to close the Add study window.

### Step 1: Stationary

- 1 In the Model Builder window under Study 3, click Step 1: Stationary .

- 2 In the Settings window for Stationary locate the Study Extensions section. Select the Auxiliary sweep checkbox.

Sweep over operating temperature at constant applied pressure, to assess the temperature sensitivity of the device.

- 3 Click Add + .
- 4 In the list in the first table cell, select the parameter T0 (Operating Temperature):

PARAMETER NAME
T0

- 5 Click Range . Go to the Range dialog.

- In the Start text field, enter 290.
- In the Step text field, enter 5.
- In the Stop text field, enter 300.

- 6 Click the Add button.

For this study, disable the default plots as these will be similar to those already generated by study 2.

- 7 In the Model Builder window, click Study 3 .

- 8 In the Settings window for Study locate the Study Settings section. Clear the Generate default plots checkbox.





- 9 Click Compute = .

## Results

---

Add a plot to show how the sensor response varies with temperature. The response is computed at an applied pressure set by the value of the parameter  $p_0$ , defined as 20 kPa.

### 1D Plot Group 11

- 1 In the Home toolbar, click Add Plot Group  and choose 1D Plot Group .
- 2 In the Settings window for 1D Plot Group locate the Data section. From the Dataset list, choose Study 3/Solution 3.
- 3 On the 1D Plot Group 11 toolbar click Global .
- 4 In the Settings window for Global click Replace Expression  in the upper-right corner of the y-Axis Data section. From the menu, navigate to Component 1 > Electrostatics > Terminals > es.C11 - Maxwell capacitance - F; then double click to select it.
- 5 Locate the y-Axis Data section. In the table, modify the first row to match the following settings:

EXPRESSION	UNIT	DESCRIPTION
es.C11	pF	Capacitance

- 6 In the Model Builder click 1D Plot Group 11 .
- 7 In the Settings window for 1D Plot Group locate the Title section.
  - From the Title type list, choose Manual.
  - In the Title text area, enter Model Capacitance vs Operating Temperature.
- 8 Locate the Plot Settings section.
  - Select the x-axis label checkbox. In the associated text field, enter Operating Temperature (K).
- 9 In the Label text field enter Capacitance vs Operating Temperature.

## 10 Click Plot .

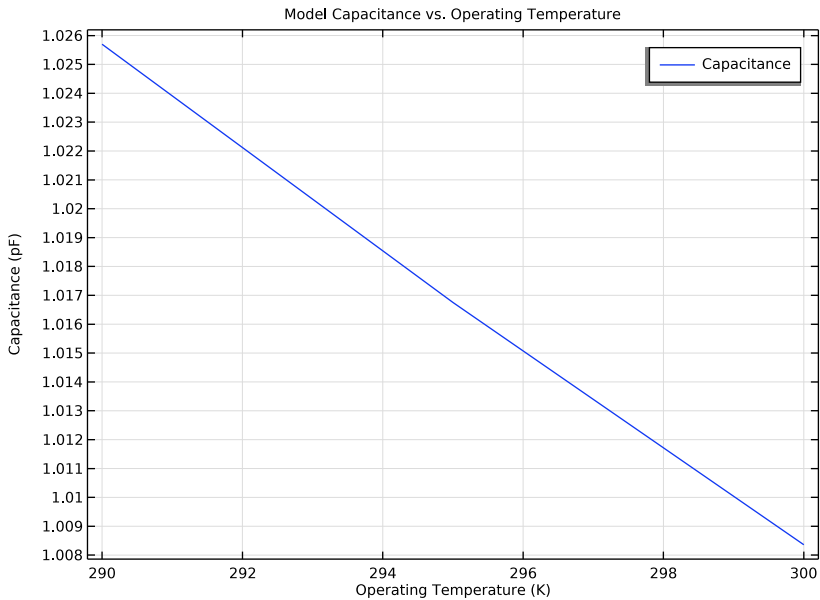

At a pressure of 20 kPa the temperature sensitivity of the model is given by the gradient of this curve, approximately  $3.5 \times 10^{-3}$  pF/K ( $14 \times 10^{-3}$  pF/K for the whole device). Given the pressure sensitivity of  $25 \times 10^{-6}$  pF/Pa at 20 kPa (for a single quadrant of the device) this corresponds to equivalent pressure of 140 Pa/K in the sensor output. Compared to the noise floor of the measuring circuit proposed in *Practical MEMS* (0.6 Pa) this number is very large. This model shows that a naive choice of packaging can have a highly detrimental effect on sensor performance.

