



INTRODUCTION TO
LiveLink™ *for* Excel®

Introduction to LiveLink™ for Excel®

© 2012–2025 COMSOL

Protected by patents listed on www.comsol.com/patents, or see Help>About COMSOL Multiphysics on the File menu in the COMSOL Desktop for less detailed lists of U.S. Patents that may apply. Patents pending.

This Documentation and the Programs described herein are furnished under the COMSOL Software License Agreement (www.comsol.com/comsol-license-agreement) and may be used or copied only under the terms of the license agreement.

COMSOL, the COMSOL logo, COMSOL Multiphysics, COMSOL Desktop, COMSOL Compiler, COMSOL Server, and LiveLink are either registered trademarks or trademarks of COMSOL AB. Microsoft, Excel, Visual Basic and Windows are either registered trademarks or trademarks of Microsoft Corporation in the United States and/or other countries. All other trademarks are the property of their respective owners, and COMSOL AB and its subsidiaries and products are not affiliated with, endorsed by, sponsored by, or supported by those or the above non-COMSOL trademark owners. For a list of such trademark owners, see www.comsol.com/trademarks.

Version: COMSOL 6.4

Contact Information

Visit the Contact COMSOL page at www.comsol.com/contact to submit general inquiries or search for an address and phone number. You can also visit the Worldwide Sales Offices page at www.comsol.com/contact/offices for address and contact information.

If you need to contact Support, an online request form is located on the COMSOL Access page at www.comsol.com/support/case. Useful links:

- Support Center: www.comsol.com/support
- Product Download: www.comsol.com/product-download
- Product Updates: www.comsol.com/product-update
- COMSOL Blog: www.comsol.com/blogs
- Discussion Forum: www.comsol.com/forum
- Events: www.comsol.com/events
- COMSOL Video Gallery: www.comsol.com/videos
- Support Knowledge Base: www.comsol.com/support/knowledgebase
- Learning Center: www.comsol.com/support/learning-center

Part number: CM023402

Contents

Introduction	5
Working with COMSOL® Models in Excel®	6
Exporting Material Data	28
Loading and Saving Excel® Files from the COMSOL Desktop®	39

Introduction

Using the LiveLink™ *for* Excel®, you can take advantage of the capabilities and structured simplicity offered by Microsoft® Excel® to extend your COMSOL Multiphysics® modeling capacity. Parameters and variables that are defined and modeled in COMSOL Multiphysics are instantly available in Excel and automatically synchronized with your physics model.

Excel® files can be loaded and saved from COMSOL Desktop. This can be used for handling parameters, variables, and interpolation data, for example, as well as loading and saving Excel files from applications.

LiveLink™ *for* Excel® adds the capability to create a COMSOL® material library from data stored in a worksheet and brings it into COMSOL Multiphysics.

Note: Interacting with COMSOL models from worksheets within Excel is only supported on Windows®. Loading and saving files is supported on all platforms and does not require Excel to be installed.

Working with COMSOL® Models in Excel®

LiveLink™ *for Excel*® enables direct access of model definitions such as parameters, variables, and functions by using the tools from the COMSOL ribbon tabs in Excel. You can also modify and update the model, recompute the solution, and extract results to a worksheet. The step-by-step instructions below detail how to work with a model in Excel spreadsheets, covering the stages of:

- Opening and saving COMSOL models
- Retrieving and updating Model Parameters
- Computing the solution and extracting results
- Updating existing data in a linked workbook

The example is based on a modified version of the model, Electrical Heating in a Busbar, from the COMSOL Multiphysics application library. The model analyzes the resistive heating of a busbar designed to conduct direct current; for details, see the *Introduction to COMSOL Multiphysics*.

Note: The step-by-step instructions below are designed to be carried out in a sequence. Skipping any of the sections might result in data not being available for the following sections. Start with [Opening a Model](#) and work through the sections until reaching the last section, [Opening a Worksheet Linked to a Model](#).

Opening a Model

- 1 Start Excel.
- 2 The first time you start Excel after having installed COMSOL you may be met with a dialog asking permission to install the COMSOL Add-in. Click OK to do so. The first result of a successful installation is that the COMSOL 6.4 Ribbon tab appears in Excel.

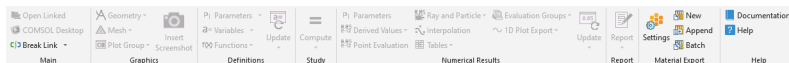

After this you can load a COMSOL model.



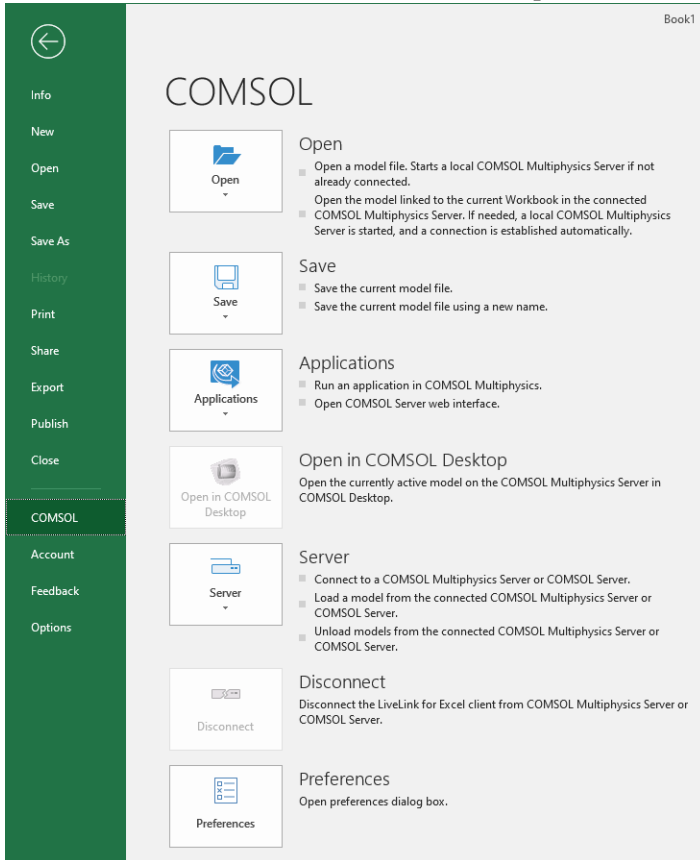

3 In the Excel File menu, select COMSOL to open the COMSOL backstage view.

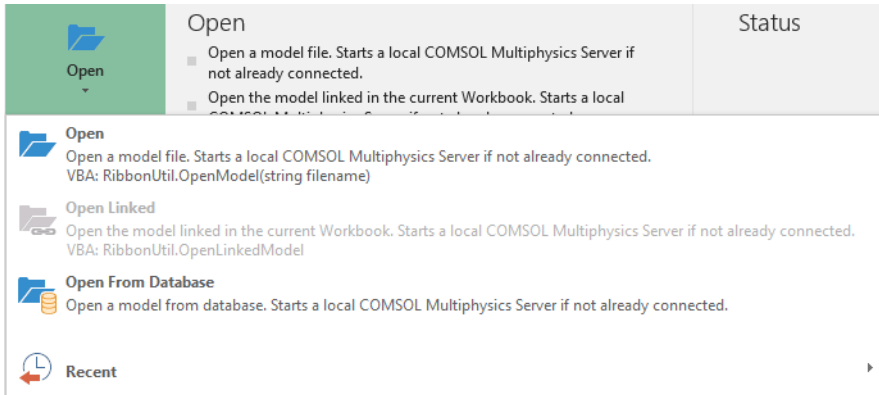

Note: In the COMSOL backstage view you can manage the COMSOL Multiphysics model, launch COMSOL Apps, connect manually to a server and set the preferences.

4 In the COMSOL backstage view click Open () to expand the open options list.



There you can choose to open a new model file (), open the model linked in the current workbook, if available (), open a model from a Model Manager database (), and open a recent file ().

- 5 As we start from blank worksheet and want to load a model from the COMSOL Application library, click Open ().
- 6 In your COMSOL installation directory, find the folder `applications/LiveLink_for_Excel/Tutorials`.
- 7 Select the file `busbar_11excel.mph` and click the Open button.

The model file is loaded onto a COMSOL Multiphysics server, which is automatically started. A graphics window automatically displays the first plot group available in the model.

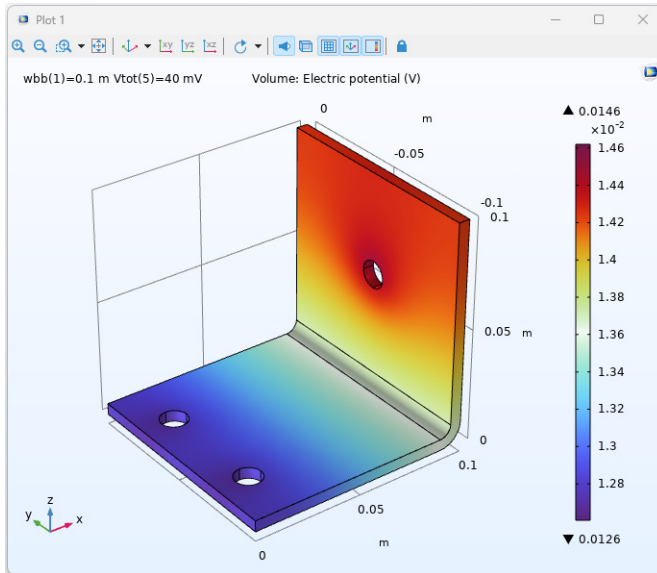

Note: In case no solution is computed, the graphics window shows the model geometry instead.

In the worksheet, the model path is automatically entered in cell B2.

	A	B	C	D	E	F	G	H	I
1	COMSOL Model								
2	Filename:	Multiphysics\applications\LiveLink_for_Excel\Tutorials\busbar_llexcel.mph							

The cell A1 contains a comment represented by a red triangle at the upper-right corner of the cell. This comment links the workbook to the model file even if you save and reopen the workbook. How to open a linked model is described in the last section of this tutorial, [Opening a Worksheet Linked to a Model](#). Do not remove this comment unless you want to break the link between the files.

	A	B
1	COMSOL Model	
2	Filename:	Multiphysics\

Note: A workbook can be linked to only one COMSOL model at a time.

Retrieving and Updating Model Parameters

Extract selected parameters from the model that you have just opened to a worksheet.

1 Select cell A4.

2 From the COMSOL 6.4 tab, Definitions group, click Parameters P_1 .

This imports all the model parameters to the worksheet and creates a direct link to the Parameters nodes in the COMSOL model.

	A	B	C	D	E	F	G	H	I
1	COMSOL Model								
2	Filename: \Multiphysics\applications\LiveLink_for_Excel\Tutorials\busbar_IIexcel.mph								
3									
4	Parameter	Expression	Unit	Descriptive	Value	Unit			
5	rad_1		6 mm	Radius of		0.006 m			
6	tbb		5 mm	Thickness		0.005 m			
7	wbb		10 cm	Width of b		0.1 m			
8	mh		6 mm	Mesh con		0.006 m			
9	Vtot		20 mV	Voltage		0.02 V			
10	L		9 cm	Length of		0.09 m			
11									

The link between the cell range in the worksheet and the COMSOL model is represented by the comment in the cell A4.

In this example we only need to access the parameter L (the length of the busbar) that is defined in the node Parameters 2.

3 To replace the imported parameters list by the one defined in Parameters 2 only, select cell A4. From the COMSOL 6.4 tab, Definitions group, under Parameters select Parameters > Parameters 2.

4 Click OK in the dialog to replace the contents of the destination cell.

	A	B	C	D	E	F	G	H	I
1	COMSOL Model								
2	Filename: \Multiphysics\applications\LiveLink_for_Excel\Tutorials\busbar_IIexcel.mph								
3									
4	Parameter	Expression	Unit	Descriptive	Value	Unit			
5	Parameters 2								
6	L		9 cm	Length		0.09 m			
7									



Note: You can retrieve parameters to several locations in a worksheet or workbook. Each time you extract model parameters, a link is created for that cell range, so that you can update the model with the selected parameter list.

You can modify the parameters in the worksheet, for example by changing their expression or description. You can also add new parameters to the list. Any change

to the list is transferred to the COMSOL model during the update operation, which is by default done automatically.

You will now change the value of the L parameter to 5 cm:

- 5 In cell B6 enter 5, the parameter L is then automatically updated to 5 in COMSOL Multiphysics.

Note: If you prefer a manual parameter update, go to the COMSOL preferences in the Backstage view and clear Automatic update checkbox. Then you can use the update button  to update the Parameters node linked to the selected cell by the comment. You can update several model definitions, such as parameters, variables, and functions, contained in the same worksheet with the Update All button  located under Update. When several Parameter table are available in the worksheet, click Update Multiple , located under Update, to select which parameter to update with the other model definitions.

To visualize the change in the model geometry due to the edited length parameter, you can display the updated geometry:

- 6 In the Graphics group, click the Geometry button  and select Geometry 1. The graphics window should now display the geometry as shown in the figure below:

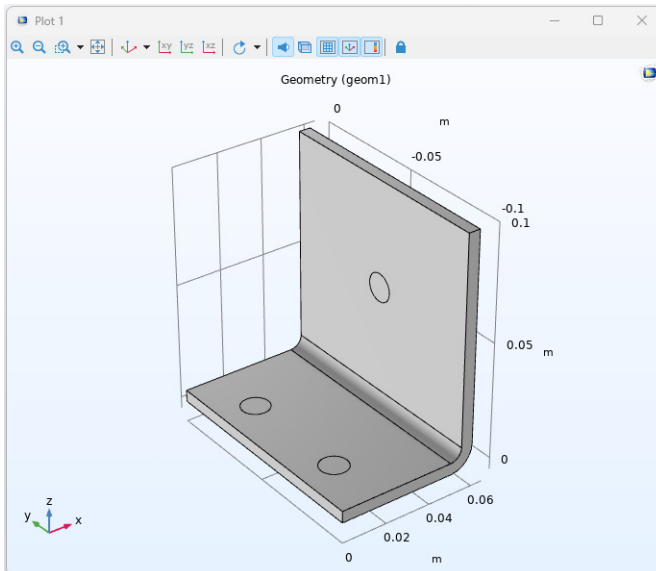

- 7 You will now set the value of parameter L back to 9 cm, in cell B6 enter 9 and press Enter. The graphics is not automatically updated so to display the newly generated geometry, select again the Geometry  > Geometry 1.

Extracting Results

The model loaded on the COMSOL Multiphysics server already contains a solution. It also contains an operator to evaluate the maximum in the busbar domain. Continue with the steps below to import the maximum temperature of the busbar to the worksheet.

POINT EVALUATION

- 1 In Sheet1, select cell A13.
- 2 From the Numerical Results group, click the Point Evaluation button ().
- 3 In the dialog that opens, select dset2 in the Dataset list. The solution dataset dset2 contains the solution stored by the parametric solver.
- 4 Select point 1 from the Selection list and enter `maxop1(T)` in the Expression text field; then click OK.

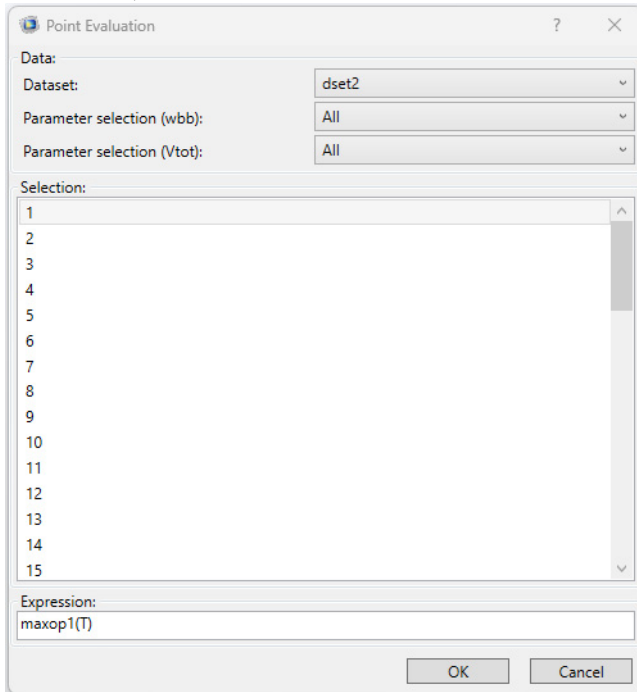

In the Excel spreadsheet, the cells containing the evaluated results are now linked to the model and can be updated if you want to recompute the solution using different parameter values.

	A	B	C	D	E	F	G	H	I
1	COMSOL Model								
2	Filename: \Multiphysics\applications\LiveLink_for_Excel\Tutorials\busbar_llexcel.mph								
3									
4	Parameter	Expression	Unit	Descriptive	Value	Unit			
5	Parameters 2								
6	L	9 cm	Length of	0.09	m				
7									
8									
9									
10									
11									
12									
13	wbb (m)	Vtot (mV) Maximum 1 (K), Point: 1							
14	0.1	5	294.0777						
15	0.1	10	296.3626						
16	0.1	20	303.165						
17	0.1	30	313.7685						
18	0.1	40	327.4474						
19									

INTERPOLATION

Continue by calculating how much heat is produced in the busbar at coordinates that you specify in the worksheet.

- 1 Add a new sheet.
- 2 In the worksheet Sheet2, enter the coordinates as shown in the figure to the right.

	A	B	C
1			
2			
3	x	y	z
4	0	0	0
5	0.025	0	0
6	0.05	0	0
7	0	-0.0125	0
8	0.025	-0.0125	0
9	0.05	-0.0125	0
10	0	-0.025	0
11	0.025	-0.025	0
12	0.05	-0.025	0
13	0	0	0.005
14	0.025	0	0.005
15	0.05	0	0.005
16	0	-0.0125	0.005
17	0.025	-0.0125	0.005
18	0.05	-0.0125	0.005
19	0	-0.025	0.005
20	0.025	-0.025	0.005
21	0.05	-0.025	0.005

- 3 Select cell D4, then go to the Numerical Results group and click Interpolation .

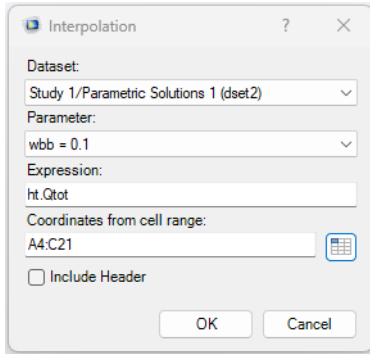

4 In the Dataset menu list, select Study 1/Parametric Solutions 1 (dset2).

5 In the Interpolation dialog, in the Expression text field, enter $ht.Q_{tot}$, which is the total heat source to be evaluated.

6 In the Coordinates from cell range text field, enter A4:C21. This is the range containing the coordinates of the interpolation points. You can also click the Select Range button () to select the cell range.

7 Finally click OK.

	A	B	C	D	E	F	G	H
1								
2								
3	x	y	z					
4	0	0	0	0.000279	0.001115	0.004459	0.010032	0.017835
5	0.025	0	0	82.09826	328.393	1313.572	2955.537	5254.288
6	0.05	0	0	117.5449	470.1795	1880.718	4231.616	7522.872
7	0	-0.0125	0	18.21687	72.8675	291.47	655.8075	1165.88
8	0.025	-0.0125	0	118.5367	474.1467	1896.587	4267.32	7586.347
9	0.05	-0.0125	0	119.6783	478.7131	1914.853	4308.418	7659.41
10	0	-0.025	0	0.009094	0.036377	0.145509	0.327395	0.582035
11	0.025	-0.025	0	200.407	801.6279	3206.512	7214.651	12826.05
12	0.05	-0.025	0	122.3379	489.3514	1957.406	4404.163	7829.623
13	0	0	0.005	0.000234	0.000937	0.00375	0.008437	0.014999
14	0.025	0	0.005	81.52432	326.0973	1304.389	2934.875	5217.556
15	0.05	0	0.005	117.5378	470.1511	1880.605	4231.36	7522.418
16	0	-0.0125	0.005	17.67914	70.71654	282.8662	636.4489	1131.465
17	0.025	-0.0125	0.005	118.0222	472.0887	1888.355	4248.798	7553.419
18	0.05	-0.0125	0.005	119.7247	478.8989	1915.595	4310.09	7662.382
19	0	-0.025	0.005	0.045856	0.183423	0.733693	1.650809	2.934771
20	0.025	-0.025	0.005	154.604	618.4159	2473.664	5565.743	9894.655
21	0.05	-0.025	0.005	122.302	489.208	1956.832	4402.872	7827.329

The evaluation results are stored in a cell range of size 18 x 5, where 18 equals the number of interpolation points and 5 is the number of parameter values contained in the solution. In this case, the solution consists of a parameter sweep over the applied voltage on the device, which varies from 5 mV to 40 mV.

- 8 You can format the worksheet for instance include column labels, insert cell at your convenience. Make sure that the cell comment remains in the worksheet to allow future updates.

	A	B	C	D	E	F	G	H
1				Qtot [W]				
2				wbb = 0.1 [m]				
3	x	y	z	5[mV]	10[mV]	20 [mV]	30 [mV]	40 [mV]
4	0	0	0	0.000279	0.001115	0.004459	0.010032	0.017835
5	0.025	0	0	82.09826	328.393	1313.572	2955.537	5254.288
6	0.05	0	0	117.5449	470.1795	1880.718	4231.616	7522.872
7	0	-0.0125	0	18.21687	72.8675	291.47	655.8075	1165.88
8	0.025	-0.0125	0	118.5367	474.1467	1896.587	4267.32	7586.347
9	0.05	-0.0125	0	119.6783	478.7131	1914.853	4308.418	7659.41
10	0	-0.025	0	0.009094	0.036377	0.145509	0.327395	0.582035
11	0.025	-0.025	0	200.407	801.6279	3206.512	7214.651	12826.05
12	0.05	-0.025	0	122.3379	489.3514	1957.406	4404.163	7829.623
13	0	0	0.005	0.000234	0.000937	0.00375	0.008437	0.014999
14	0.025	0	0.005	81.52432	326.0973	1304.389	2934.875	5217.556
15	0.05	0	0.005	117.5378	470.1511	1880.605	4231.36	7522.418
16	0	-0.0125	0.005	17.67914	70.71654	282.8662	636.4489	1131.465
17	0.025	-0.0125	0.005	118.0222	472.0887	1888.355	4248.798	7553.419
18	0.05	-0.0125	0.005	119.7247	478.8989	1915.595	4310.09	7662.382
19	0	-0.025	0.005	0.045856	0.183423	0.733693	1.650809	2.934771
20	0.025	-0.025	0.005	154.604	618.4159	2473.664	5565.743	9894.655
21	0.05	-0.025	0.005	122.302	489.208	1956.832	4402.872	7827.329
22								

Displaying the Solution

You can display the solution using the plot group defined in the model. You can find the plot groups available in the Plot Group list.

- 1 Click the Plot Group button  , from the Graphics group, to select the plot group to display. Here, select Temperature (ht) (pg3).

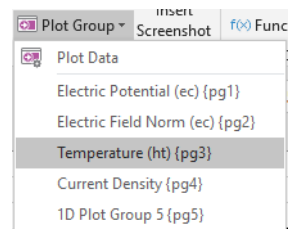

The graphics window now displays the temperature distribution in the busbar as in the figure below:

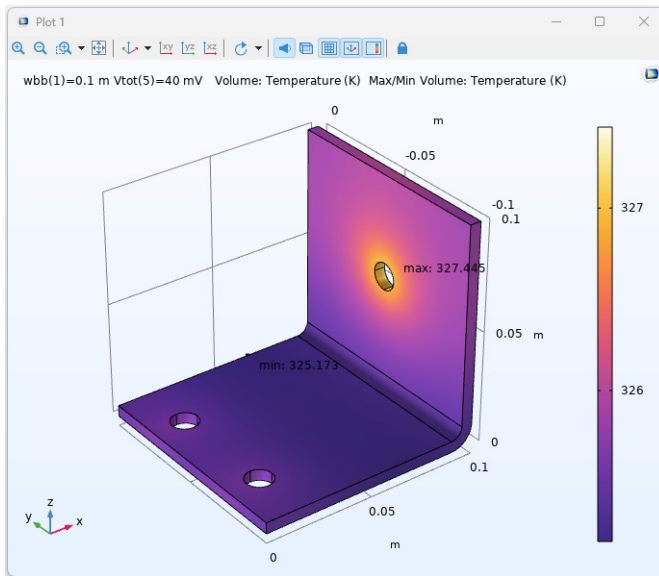

The plot represents the solution from the saved model.

Note: For time dependent solutions or parametric sweeps, you can select the solution to display by selecting the Plot Group > Plot Data  from the Graphics group on the ribbon tab.

- To insert the displayed image into the worksheet, switch to Sheet 1 and select cell E13, then click Insert Screenshot  from the Graphics group.

Parameter	Expression	Unit	Description	Value	Unit
Parameters 2					
L		9 cm	Length of	0.09 m	

wbb (m)	Vtot (mV)	Maximum 1 (K), Poi
0.1	5	294.0777
0.1	10	296.3626
0.1	20	303.165
0.1	30	313.7685
0.1	40	327.4474

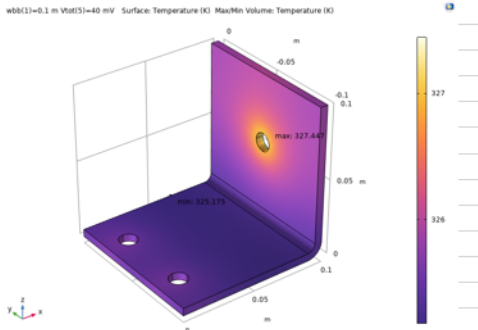

Note: While you can manually adjust the size of the image, you can also specify the graphics scale when inserting the displayed image. You can find the settings for inserting graphics in the Preferences window, which is accessible from the COMSOL Backstage view.

Running Model in Sweep

This model of the busbar contains a Parametric Sweep node and a Stationary node including an Auxiliary sweep. You can insert the sweep settings into a worksheet to control the parameter values for the sweep from there.

- Select cell A8 in Sheet 1 and from the Study group on the ribbon tab select Compute > Sweep  to open the Sweep dialog. In the Sweep dialog, you can

see that the current sweep node is defined with the busbar width parameter (wbb) set to the value $10e-2$.

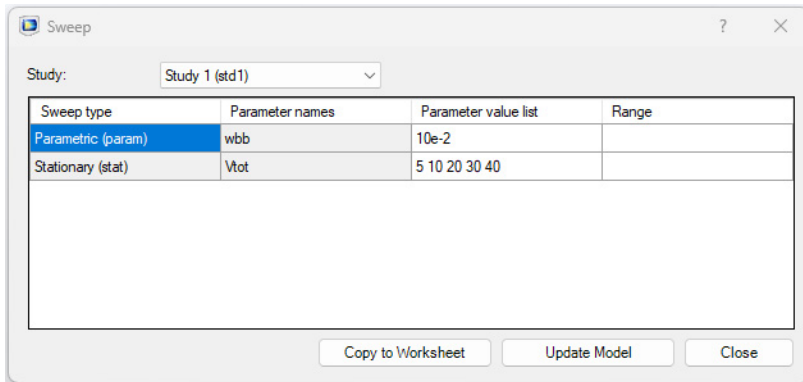

- 2 Click Copy to Worksheet to insert the sweep parameter data starting at cell A8 and create a link between the cell range and the model.
- 3 To be able to edit the worksheet, first click Close to close the Sweep dialog.
- 4 Add additional parameter values to the parametric sweep, in cell B9 enter 0.05, in C9 enter 0.1 and in D9 enter 0.15.
- 5 You will now update the model with the additional parameter values, select A8 and click Compute > Sweep .

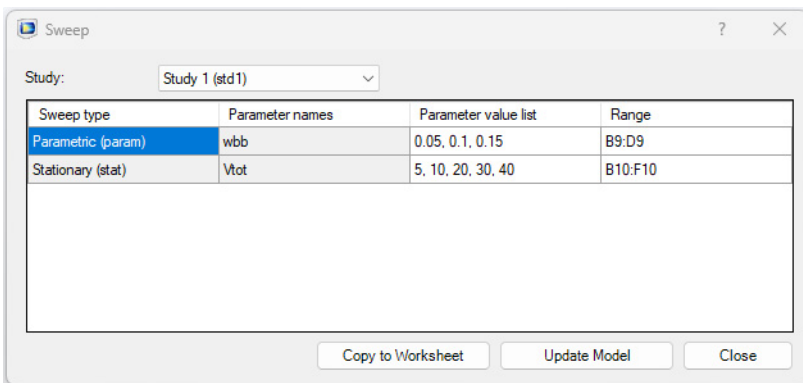



- 6 You may notice that the parameter value list and the range columns are updated with the new values. Click Update Model to send these parameter values to the model.

Computing the Solution

Continue with solving the model.

1 In the Study group, click the Compute button .

In case the model contains several studies, you can select Compute > Study , then select the study to solve.

2 From the Graphics group, click the Plot Group button , then select Temperature (ht) (pg3).

The Graphics window is updated with the temperature distribution in the busbar for the first width parameter value in the recomputed sweep.

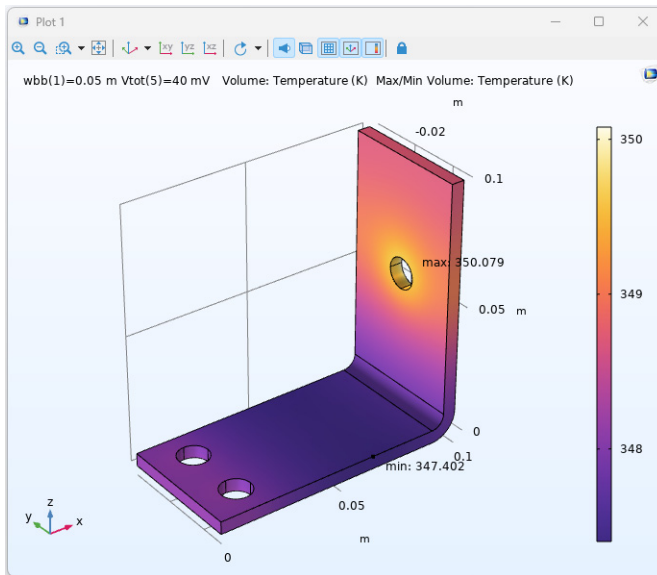

Updating Data in a Worksheet

Now that you have a workbook containing model definitions and data evaluation linked to a COMSOL model, you can easily modify and recompute the model from the workbook, while keeping the evaluated results up to date.

Follow the steps below to update the results in Sheet1 and Sheet2.

1 Make sure that Sheet 1 is active, then on the ribbon tab, Numerical Results group, click Update  to update all the numerical results in the worksheet. The point evaluation now includes results for different values of the busbar width.

2 To update the image in Sheet 1, delete the existing image first, then insert it again by clicking Insert Screenshot.

You can select Plot Group > Plot Data  to display the solution for a different value of the busbar width.

	A	B	C	D	E	F	G	H	I	J
1	COMSOL Model									
2	Filename: \\Multiphysics\applications\LiveLink_for_Excel\Tutorials\busbar_l\excel.mph									
3										
4	Parameter	Expression	Unit	Descriptive Value	Unit					
5	Parameters 2									
6	L		9 cm	Length of	0.09 m					
7										
8	Name	Expressions								
9	wbb	5.00E-02	0.1	0.15						
10	Vtot	5	10	20	30	40				
11										
12										
13	wbb (m)	Vtot (mV)	Maximum 1 (K), Point	wbb(1)=0.05 m Vtot(5)=40 mV Surface: Temperature (K) Max/Min Volume: Temperature (K)						
14	0.05	5	294.759							
15	0.05	10	298.3787							
16	0.05	20	310.0022							
17	0.05	30	327.6517							
18	0.05	40	350.0916							
19	0.1	5	294.0777							
20	0.1	10	296.3625							
21	0.1	20	303.1644							
22	0.1	30	313.7671							
23	0.1	40	327.4447							
24	0.15	5	293.8077							
25	0.15	10	295.511							
26	0.15	20	300.6511							
27	0.15	30	308.216							
28	0.15	40	318.357							

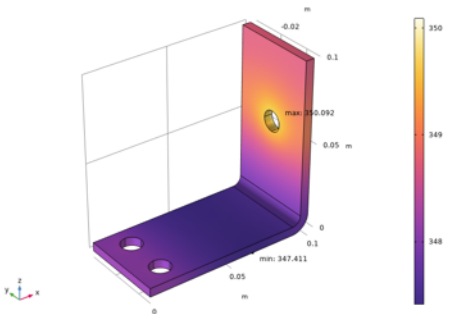

3 To update the total heat source interpolation only, switch to Sheet2, and select the cell that contains the Interpolation comment, cell D3 if you did not change the worksheet format.

4 In the Numerical Results group click Update .

	A	B	C	D	E	F	G	H
1				Qtot [W]				
2				wbb = 0.05 [m]				
3	x	y	z	5[mV]	10[mV]	20 [mV]	30 [mV]	40 [mV]
4	0	0	0	0.1154	0.4616	1.846401	4.154403	7.385605
5	0.025	0	0	476.7288	1906.915	7627.662	17162.24	30510.65
6	0.05	0	0	449.2789	1797.116	7188.462	16174.04	28753.85
7	0	-0.0125	0	0.007511	0.030046	0.120183	0.270412	0.480733
8	0.025	-0.0125	0	438.9238	1755.695	7022.781	15801.26	28091.12
9	0.05	-0.0125	0	449.1285	1796.514	7186.056	16168.63	28744.22
10	0	-0.025	0	0.019243	0.076973	0.307894	0.692761	1.231575
11	0.025	-0.025	0	479.1549	1916.619	7666.478	17249.57	30665.91
12	0.05	-0.025	0	449.2702	1797.081	7188.323	16173.73	28753.29
13	0	0	0.005	0.166757	0.667028	2.66811	6.003248	10.67244
14	0.025	0	0.005	477.7326	1910.93	7643.721	17198.37	30574.89
15	0.05	0	0.005	449.2783	1797.113	7188.453	16174.02	28753.81
16	0	-0.0125	0.005	0.028579	0.114316	0.457264	1.028843	1.829055
17	0.025	-0.0125	0.005	358.103	1432.412	5729.648	12891.71	22918.59
18	0.05	-0.0125	0.005	449.1298	1796.519	7186.077	16168.67	28744.31
19	0	-0.025	0.005	0.016167	0.064668	0.258673	0.582015	1.034692
20	0.025	-0.025	0.005	476.4002	1905.601	7622.403	17150.41	30489.61
21	0.05	-0.025	0.005	449.2586	1797.035	7188.138	16173.31	28752.55

Note that the new values correspond to the busbar width set to 5 cm. You need to manually update the table header to reflect this.

- You can continue to import data for other value of wbb, the easiest way is to copy the cell that contains the interpolation comment (D4) and paste it at the desired cell location, say I4.
- Click the Interpolation button  and select from the Parameter menu list the second parameter value (wbb = 0.1) and click OK. A COMSOL dialog appears, click OK to confirm replacing the contents of the destination cells.

	A	B	C	D	E	F	G	H	I	J	K	L	M
1				Qtot [W]									
2				wbb = 0.05 [m]					wbb = 0.1 [m]				
3	x	y	z	5[mV]	10[mV]	20 [mV]	30 [mV]	40 [mV]	5[mV]	10[mV]	20 [mV]	30 [mV]	40 [mV]
4	0	0	0	0.1154	0.4616	1.846401	4.154403	7.385605	0.00029	0.001159	0.004634	0.010428	0.018538
5	0.025	0	0	476.7288	1906.915	7627.662	17162.24	30510.65	82.15978	328.6391	1314.556	2957.752	5258.226
6	0.05	0	0	449.2789	1797.116	7188.462	16174.04	28753.85	117.6019	470.4077	1881.631	4233.669	7526.523
7	0	-0.0125	0	0.007511	0.030046	0.120183	0.270412	0.480733	18.22077	72.88309	291.5324	655.9478	1166.129
8	0.025	-0.0125	0	438.9238	1755.695	7022.781	15801.26	28091.12	118.6674	474.6697	1898.679	4272.027	7594.715
9	0.05	-0.0125	0	449.1285	1796.514	7186.056	16168.63	28744.22	119.7334	478.9336	1915.734	4310.402	7662.938
10	0	-0.025	0	0.019243	0.076973	0.307894	0.692761	1.231575	0.007995	0.031981	0.127924	0.28783	0.511698
11	0.025	-0.025	0	479.1549	1916.619	7666.478	17249.57	30665.91	200.3633	801.4532	3205.813	7213.079	12823.25
12	0.05	-0.025	0	449.2702	1797.081	7188.323	16173.73	28753.29	122.3863	489.5453	1958.181	4405.908	7832.725
13	0	0	0.005	0.166757	0.667028	2.66811	6.003248	10.67244	0.000238	0.000952	0.003808	0.008567	0.015231
14	0.025	0	0.005	477.7326	1910.93	7643.721	17198.37	30574.89	81.57955	326.3182	1305.273	2936.864	5221.091
15	0.05	0	0.005	449.2783	1797.113	7188.453	16174.02	28753.81	117.5948	470.3793	1881.517	4233.414	7526.069
16	0	-0.0125	0.005	0.028579	0.114316	0.457264	1.028843	1.829055	17.67704	70.70816	282.8326	636.3735	1131.331
17	0.025	-0.0125	0.005	358.103	1432.412	5729.648	12891.71	22918.59	118.1199	472.4795	1889.918	4252.315	7559.671
18	0.05	-0.0125	0.005	449.1298	1796.519	7186.077	16168.67	28744.31	119.7398	478.1196	1916.478	4313.077	7665.914

- 7 Finally repeat the two previous steps to insert the results for the third width parameter value ($w_{bb} = 0.15$) starting at cell N4.

Importing 1D Plot Data

If your model contains 1D plots you can in one step extract the plot data to a worksheet and create an Excel chart.

The currently open model of the busbar contains a 1D plot of the maximum temperature plotted against the applied voltage for the different width parameter values.

- 1 From the Graphics group, click the Plot Group button , then select 1D Plot Group5 (pg5) to display it in the Graphics window.

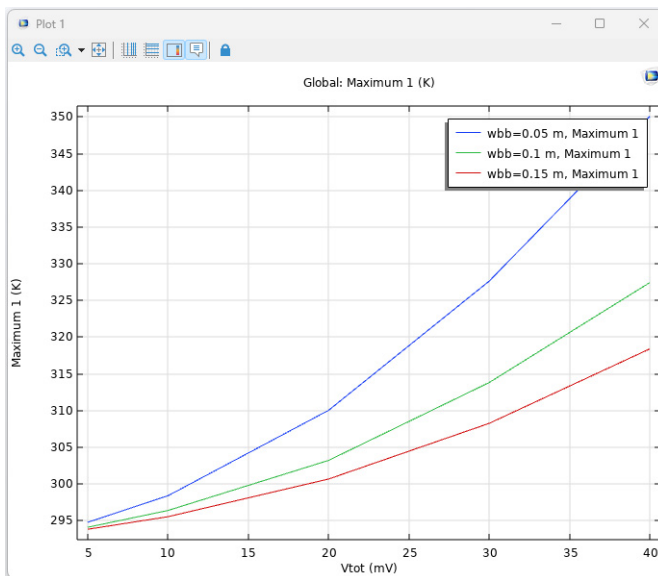

Instead of inserting this plot as a static image, we will insert the plot data, and create a scatter chart in the worksheet.

- 2 In Sheet 1 delete the previously inserted image, and select cell E13.
- 3 Click the 1D Plot Export button , and select 1D Plot Group 5 (pg5).

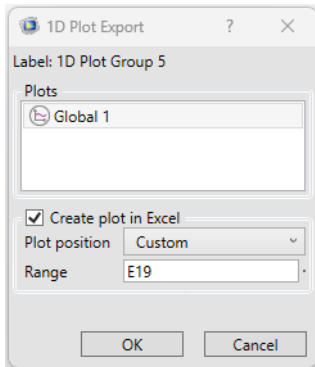

4 This opens a dialog where you can select the data to be inserted into the worksheet.

In case the selected plot group contains more than one plot, the plot features appear in the Plots list, and you can select those that you want to extract data from. In this case, 1D Plot Group 5 contains the Global 1 plot feature that is already selected. With the default settings a chart based on the extracted data is also created in the sheet. Use the Plot position setting to select where to place the chart on the sheet.

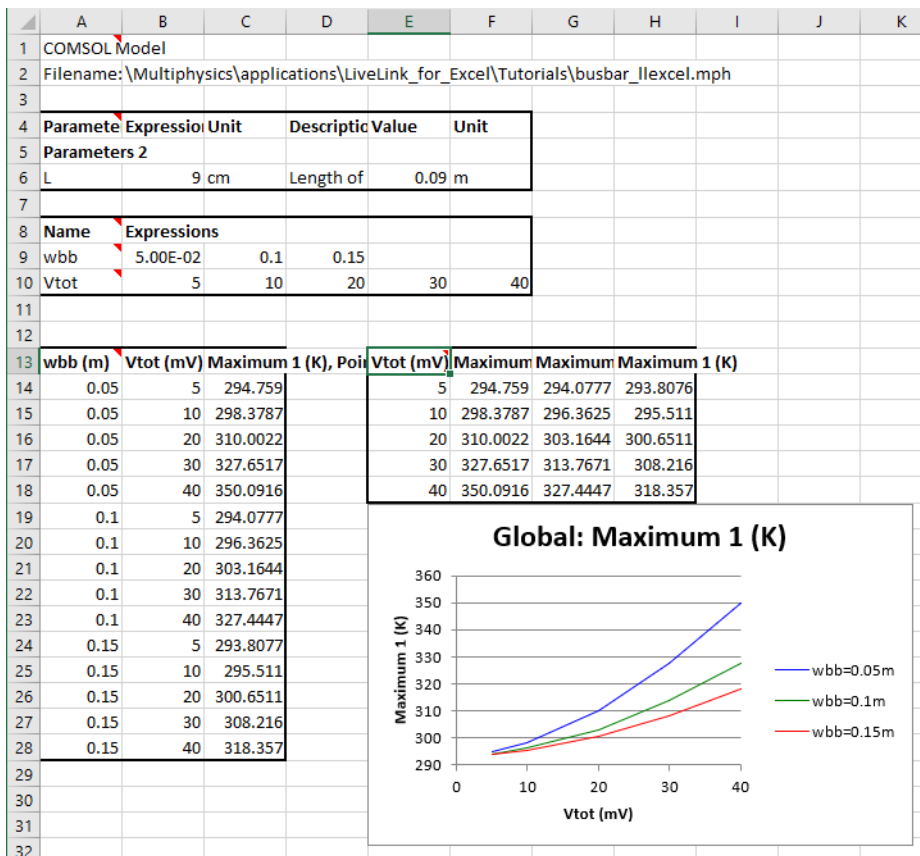

5 From the Plot position list, select Custom and enter E19 in the Range field. Click OK.

The final chart looks like this when using the default settings:



Saving the Model and the Workbook

To keep the changes you have applied to the busbar model, save it to the MPH-format. To avoid writing over the model from the Application Libraries, use the Save As button.

- 1 Go to the Excel File menu and select COMSOL. In the COMSOL backstage view click Save button  and then select Save As , then save the file to a location outside the COMSOL Application Libraries.
- 2 Continue with saving the Excel workbook, go to the File menu and select Save.

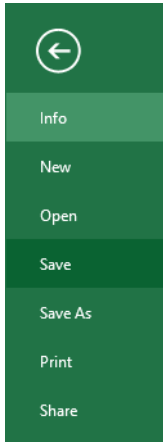

- 3 You can now exit Excel, which automatically closes the COMSOL Model window as well.

Opening a Worksheet Linked to a Model

Once you have created a link to a COMSOL model in an Excel workbook and saved the file, you can reopen the Excel file and update the link.

- 1 Start Excel and open the file you have saved in step 2 of the section [Saving the Model and the Workbook](#).
- 2 From the Main group of the COMSOL ribbon tab click Open linked .

Note: The path of the linked model is set in the COMSOL Model cell comment. If necessary you can manually edit the cell comment to update the model path.

You can now continue your work with the model in Excel.

Automating Using Visual Basic for Applications (VBA)

Using VBA macros in Excel workbooks you can automate operations between the workbook and a COMSOL model. For instance, it is possible to create a macro that automatically updates the list of parameters for a parametric sweep in a model, computes the solution, and inserts results into a sheet.

Follow the short example below that illustrates some of the possibilities for using VBA when working with a COMSOL model. Running the code in the example requires that LiveLink™ for Excel® is installed, and that a reference to the COMSOL API component has been added to the VBA project in the workbook. For information on how to do this see [Before You Start](#) in the LiveLink™ for Excel® User's Guide.

To load or create a COMSOL model in a VBA macro it is necessary to use the class ModelUtil, which is one of the three classes available with the COMSOL API for VBA. In addition to ModelUtil, the class ComsolUtil provides additional utility functions, for example for starting a COMSOL Multiphysics server. Lastly, the class RibbonUtil contains the wrapper functions corresponding to the buttons of the COMSOL tab.

The example below loads the busbar model from the Application Libraries, creates a plot, and extracts numerical data into a worksheet. Follow the steps with detailed explanations, and type in the commands, or jump ahead and copy the entire subroutine from [Code for use with VBA](#), then paste it into the VBA editor.

- 1 In the Developer tab in Excel, click the Visual Basic button to start the Microsoft Visual Basic for Applications interface.
- 2 From the Insert menu, select Module.
- 3 In the Module 1 editor start editing the subroutine:

```
Sub Example()
```
- 4 Create the instances for the objects that provide the COMSOL API functions:

```
Set ComsolUtil = CreateObject("comsolcom.comsolutil")
Set ModelUtil = CreateObject("comsolcom.modelutil")
Set RibbonUtil = ComsolUtil.GetRibbonUtil
```
- 5 Open the model file busbar.mph from the COMSOL Multiphysics Application Libraries

```
Range("A1").Select
Set model = RibbonUtil.OpenModel("busbar.mph")
```

You do not need to include the file path as long as you are opening a model from the COMSOL Application Libraries, or the model is saved at the same location as the current workbook. Once the model is loaded, a message is displayed in the COMSOL Multiphysics server window.

6 Write in the worksheet the coordinates to use for the data interpolation as in the figure below:

x	y	z
0	0	0
2.50E-02	0	0
5.00E-02	0	0
0	-1.25E-02	0
2.50E-02	-1.25E-02	0
5.00E-02	-1.25E-02	0
0	-2.50E-02	0
2.50E-02	-2.50E-02	0
5.00E-02	-2.50E-02	0

```

Range("A3").Value = "X"
Range("B3").Value = "Y"
Range("C3").Value = "Z"
Range("A4:C12").Value = 0
Range("A5").Value = 2.5e-2
Range("A6").Value = 5e-2
Range("B7").Value = -1.25e-2
Range("B10").Value = -2.5e-2
Range("A7:A9").Value = Range("A4:A6").Value
Range("A10:A12").Value = Range("A4:A6").Value
Range("B8:B9").Value = Range("B7").Value
Range("B11:B12").Value = Range("B10").Value

```

7 Extract the temperature from the model using interpolation coordinates

```

Range("D3").Select
RibbonUtil.ResultsInterpolation "dset1", "T", "A4:C12", True

```

The above code creates a link between Excel and the COMSOL model, which defines an interpolation evaluation at the coordinates provided in the cell range A4:C12. You can reuse this link later on to update the evaluation after you have computed a new solution.

8 End the subroutine

```
End Sub
```

9 To run the subroutine click the **Run Sub/User Form** button or press F5

Once you have run the subroutine the ribbon is connected to the COMSOL Multiphysics server. You do not need to open the model again.

CODE FOR USE WITH VBA

Below you find the full script of the example. You can copy it and paste it into the VBA editor. In the code below, replace *<COMSOLPATH>* with your local COMSOL Multiphysics installation directory.

```

Sub Example()

Set ComsolUtil = CreateObject("comsolcom.comsolutil")

```

```

Set ModelUtil = CreateObject("comsolcom.modelutil")
Set RibbonUtil = ComsolUtil.GetRibbonUtil

Range("A1").Select
Set Model = RibbonUtil.OpenModel("busbar.mph")

Range("A3").Value = "X"
Range("B3").Value = "Y"
Range("C3").Value = "Z"
Range("A4:C12").Value = 0
Range("A5").Value = 2.5e-2
Range("A6").Value = 5e-2
Range("B7").Value = -1.25e-2
Range("B10").Value = -2.5e-2
Range("A7:A9").Value = Range("A4:A6").Value
Range("A10:A12").Value = Range("A4:A6").Value
Range("B8:B9").Value = Range("B7").Value
Range("B11:B12").Value = Range("B10").Value

Range("D3").Select
RibbonUtil.ResultsInterpolation "dset1", "T", "A4:C12", True
End Sub

```

For more information about the COMSOL API for VBA refer to the LiveLink for Excel User's Guide Manual. More examples are included in the file `busbar_1l1excel.xlsm` that you can find in your COMSOL Multiphysics installation directory and in the folder `applications/LiveLink_for_Excel/Tutorials`

Exporting Material Data

Using LiveLink™ *for* Excel® you can easily convert material properties saved in a worksheet to a COMSOL material library. The Material Export group of the COMSOL tab in Excel contains the tools to format and export the material data. Follow the instructions below to create a user-defined material library that will be available automatically in the Material Browser in the COMSOL Desktop.

In this section, step-by-step instructions show you how to export the data stored in a spreadsheet to a material library in the COMSOL format. The first part of the example shows how to define the export settings from constant data. The second part of the example illustrates how to set the export from data field depending on the physical quantity; you will consider temperature in this particular example. Finally, in the last part, you will export the data from the spreadsheet to a COMSOL material library.

Defining Material Export Settings from Constant Data

In this section, you will set up the material export using data stored as constants in the spreadsheet.

Note: The export procedure described in this chapter assumes that the data are stored in the spreadsheet with the material names in a single column and the material property names in a single row. The data are placed at the intersection cell of the material name and the property name.

	A	B	C
1		thermal conductivity (W/m/K)	density (lb/in ³)
2	Copper	400	3.14E-01
3	Titanium	10	1.79E-01
4	Aluminum	150	9.75E-02

- 1 Start Excel and open the file `busbar_11excel_data.xlsx` that you can find in your COMSOL Multiphysics installation directory and in the folder `applications/LiveLink_for_Excel/Tutorials`.
- 2 Go to the worksheet `Materials` which contains the definitions of physical properties for four different materials. The material properties listed are thermal conductivity, density, heat capacity at constant pressure, relative permittivity and

electric conductivity. All properties are defined in SI units, except for density, which has the unit lb/in³.

	A	B	C	D	E	F
1		thermal conductivity (W/m/K)	density (lb/in ³)	Cp (J/kg/K)	Relative permittivity	sigma (S/m)
2	Copper	400	3.14E-01	380	1	6.00E+07
3	Titanium	10	1.79E-01	700	1	7.40E+05
4	Aluminum	150	9.75E-02	900	1	3.50E+07
5	Steel	50	2.82E-01	480	1	4.00E+06

- 3 On the COMSOL 6.4 tab, click Settings  to open the Material Export Settings dialog.

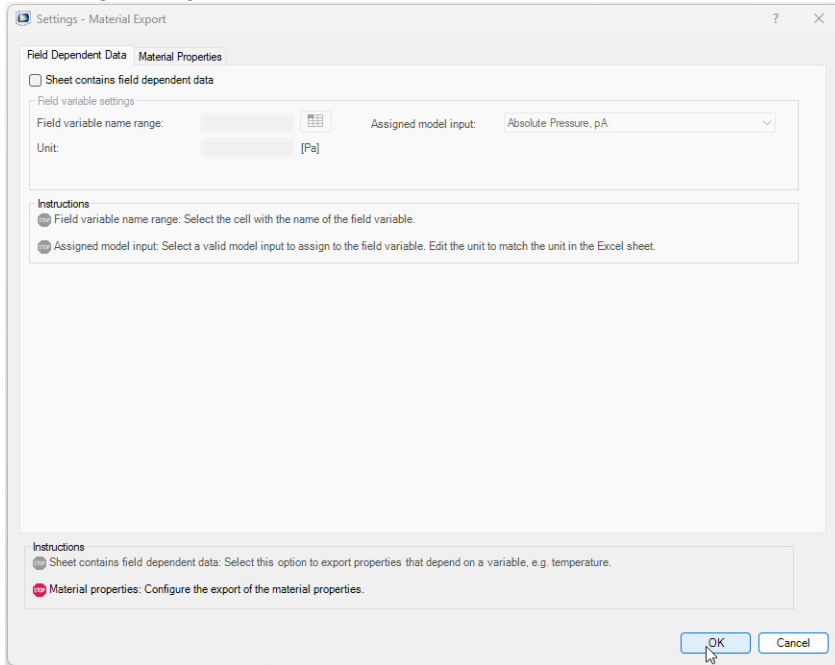



In the Settings dialog you can select materials and properties to export. This is also where you associate each material property from the worksheet with a property recognized by COMSOL.

Export depends on the format of the data stored in the worksheet; you can have material properties defined with constant values or ones that depend on field data, such as temperature. In the worksheet Materials, you can see that the properties are defined as constant.

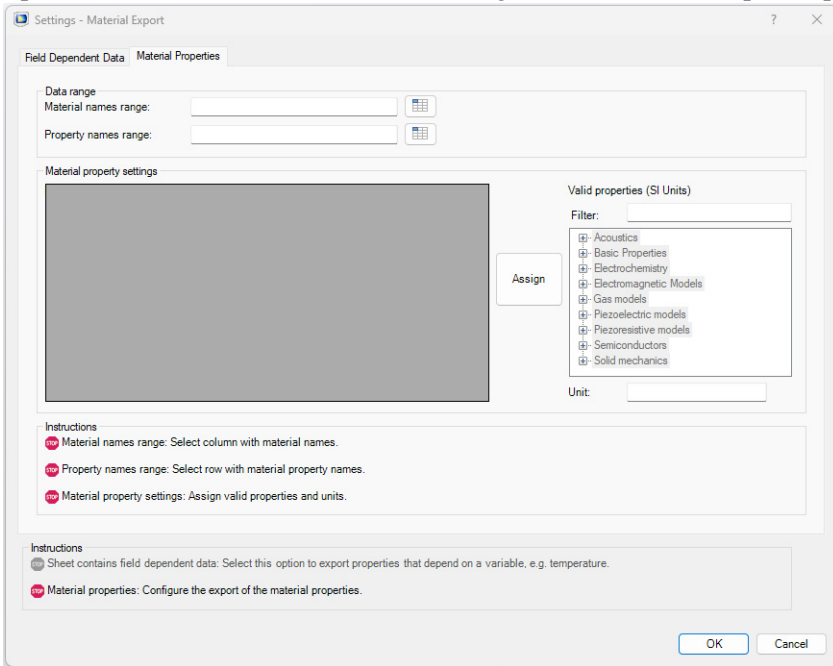
- 4 In the Field Dependent Data page, make sure that the Sheet contains field dependent data checkbox is not selected and go to the Material Properties page.



- 5 You will now select the cells containing the material names. Click the Range button () next to the Material names range text field.
- 6 Select the range A2:A5 in the sheet and click OK.
- 7 Continue by selecting the cells with the property names. Click the Range button () to the right of the Property names range text field.
- 8 Select the range B1:F1 and click OK.

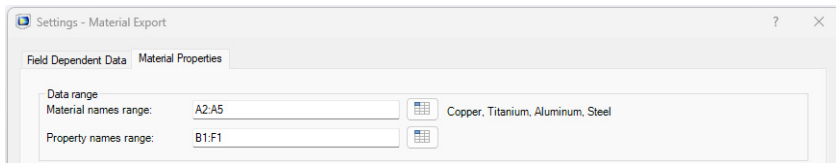

The properties are now listed in the table in the Material property settings section. You now need to assign valid COMSOL properties to the material properties in the spreadsheet.

- 9 From the Material property settings table select thermal conductivity (W/m/K), then go to the Valid properties (SI Units) list and expand Basic Properties.

10 Select Thermal conductivity -k [W/(m*K)] and click Assign.

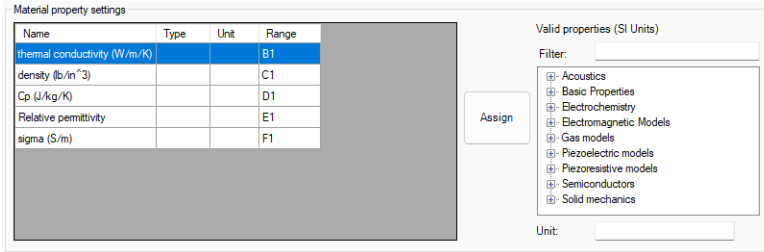

Note that the number of properties remaining to be assigned is displayed in the Instructions section.

11 In the Material property settings table now select density (lb/in³) from the Name column.

12 Under Valid properties (SI Units) in the Filter field enter Density to search for all available properties density type, and select Density - rho [kg/m³].

As density data in the worksheet are not defined in SI unit (kg/m³), you need to specify the material properties unit.

13 Below the valid properties list, locate the Unit text field and enter lb/in³.

14 Click Assign to assign the properties and the unit to the data in the spreadsheet.

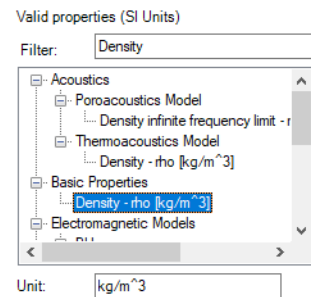

15 Repeat step 8 and 9 for the remaining material properties. Select valid properties according to the table below:

PROPERTY NAMES	VALID PROPERTIES (SI UNITS)	UNIT
Cp (J/(kg*K))	Heat capacity at constant pressure - Cp [J/(kg*K)]	J/(kg*K)
Relative permittivity	Relative permittivity - epsilon _r [1]	1
sigma (S/m)	Electric conductivity - sigma [S/m]	S/m

Once there are no unassigned properties remaining, a check mark appears next to the last step in the Instructions section.

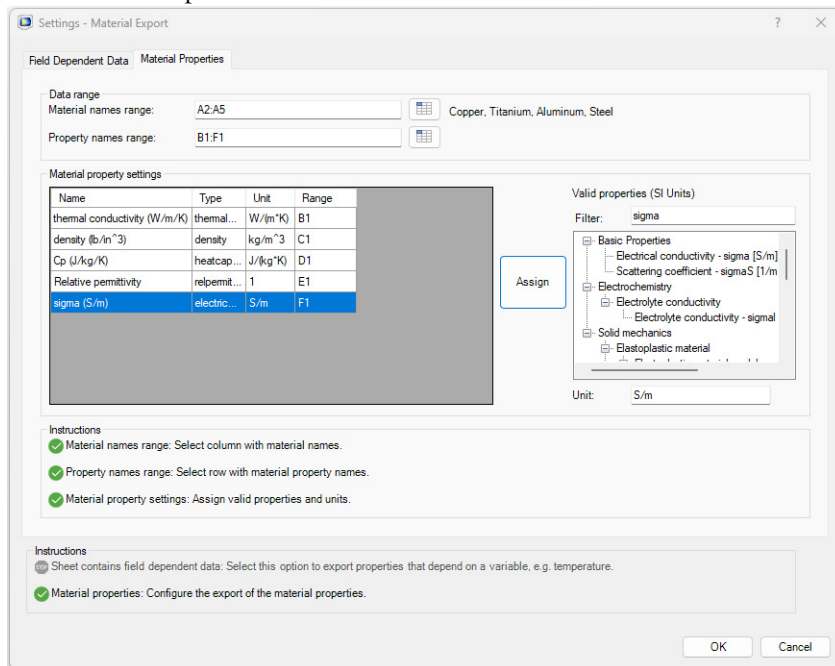

16 Click OK to save the settings, and to close the dialog.

Note that comments now appear on the cells containing the material names and properties.

	A	B	C	D	E	F
1		thermal conductivity (W/m/K)	density (lb/in ³)	Cp (J/kg/K)	Relative permittivity	sigma (S/m)
2	Copper	400	3.14E-01	380	1	6.00E+07
3	Titanium	10	1.79E-01	700	1	7.40E+05
4	Aluminum	150	9.75E-02	900	1	3.50E+07
5	Steel	50	2.82E-01	480	1	4.00E+06

These comments contain the configuration for the material data export that you have just set up. Make sure not to remove them before completing the export. To modify the settings you can return to the Settings dialog.

You can also use these settings as a template to run the export in a batch.

Defining Material Export Settings from Field Data

In this section you will continue to define the material export settings, but this time using data defined as fields that depend on a variable. A valid field variable corresponds to model inputs in the COMSOL model. Typical examples include physical quantities such as temperature, concentration, and frequency. See [About Model Inputs](#) in the *COMSOL Multiphysics Reference Manual* to get a complete list of valid model inputs.

You can choose to export the material properties as tabulated data or constant values.



Note: The export procedure described in this chapter assumes that data is stored in the spreadsheet with the field variable data in a single column and the material property names in a single row. The data are placed at the intersection cells of the field data and the property name. It also assumes one material per sheet.

	A	B
1	Water, liquid	
2	T (K)	eta (Pa*s)
3	273.15	0.0017915
4	278.15	0.0015356
5	283.15	0.0013248
6	288.15	0.0011516

1 In the workbook `busbar_11excel_data.xlsx`, go to the worksheet `Water, liquid` that contains the definitions for the dynamic viscosity, heat capacity at constant pressure, density, and thermal conductivity of liquid water. The

spreadsheet includes property data in the temperature range 273.15 K to 518.15 K.

	A	B	C	D	E
1	Water, liquid				
2	T (K)	eta (Pa*s)	Cp (J/(kg*K))	rho (kg/m^3)	k (W/(m*K))
3	273.15	0.0017915	4216.2779	1003.9209	0.55623
4	278.15	0.0015356	4206.8543	1003.0467	0.56642
5	283.15	0.0013248	4198.8844	1002.0375	0.57614
6	288.15	0.0011516	4192.27	1000.8935	0.58541
7	293.15	0.0010093	4186.9181	999.6151	0.59423
8	298.15	0.00089255	4182.7412	998.2024	0.60261
9	303.15	0.00079641	4179.6571	996.6558	0.61055
10	308.15	0.00071689	4177.5892	994.9755	0.61807
11	313.15	0.00065064	4176.4663	993.1619	0.62516
12	318.15	0.0005949	4176.2226	991.2152	0.63184
13	323.15	0.00054741	4176.7979	989.1356	0.6381
14	328.15	0.00050638	4178.1371	986.9235	0.64396
15	333.15	0.0004704	4180.1909	984.5792	0.64942

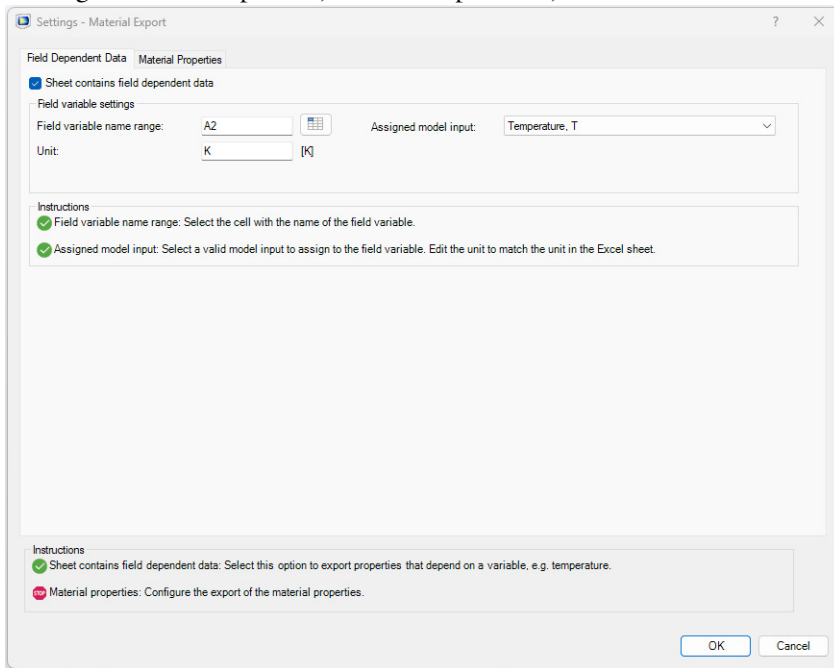

- 2 On the COMSOL 6.4 tab, click Settings  to open the Material Export Settings dialog.
- 3 In the Field Dependent Data page, select Sheet contains field dependent data checkbox.
- 4 Now select the range where the field variable is defined. Click the Range button () next to the Field variable name range text field and select the range A2 in the sheet. Click OK to validate the selection.

- 5 In the next step, assign a valid model input to the selected variable field. In the Assigned model input list, select Temperature, T.



Note: If the data stored in the worksheet are not defined in SI units, you need to update the Unit text field.

You can verify that all requirements in the field dependent page are set when the instructions list only contains green check marks (✓).

- 6 Go to the Material properties page to continue with the material library export settings.
- 7 You will now select the cells containing the material names. Click the Range button () next to the Material names range text field.
- 8 Select cell A1 in the sheet and click OK.
- 9 Continue by selecting the cells with the property names. Click the Range button () to the right of the Property names range text field.
- 10 Select the range B2:E2 and click OK.

The properties are now listed in the table in the Material property settings section. You now need to assign valid COMSOL properties to the material properties in the spreadsheet.

- 1 From the Material property settings table select eta (Pa*s), then go to the Valid properties (SI Units) list and expand Basic Properties.
- 2 Select Dynamic viscosity - mu [Pa*s] and click Assign.

Material property settings

Name	Type	Unit	Range	Constant
eta (Pa*s)	dynamic...	Pa*s	B2	<input checked="" type="checkbox"/>
Cp (J/(kg*K))			C2	<input type="checkbox"/>
rho (kg/m^3)			D2	<input type="checkbox"/>
k (W/(m*K))			E2	<input type="checkbox"/>

Assign

Valid properties (SI Units)

Filter:

- Dynamic viscosity - mu [Pa*s]
- Electrical conductivity - sigma [S/m]
- Electron mobility - mue [m^2/(V*s)]
- Extinction coefficient - betaR [1/m]
- Frequency factor - alpha [1/s]
- Heat capacity at constant pressure
- Isotropic structural loss factor - eta s
- Mass flux - M [kg/(m^2*s)]

Unit:

Instructions

- ✓ Material names range: Select column with material names.
- ✓ Property names range: Select row with material property names.
- ✗ Material property settings: Assign valid properties and units.

Note that the number of properties remaining to be assigned is displayed in the Instructions section.

13 Repeat steps 11 and 12 for the remaining material properties. Select valid properties according to the table below:

PROPERTY NAMES	VALID PROPERTIES (SI UNITS)	UNIT
Cp (J/(kg*K))	Heat capacity at constant pressure - Cp [J/(kg*K)]	J/(kg*K)
rho(kg/m^3)	Density - rho [kg/m^3]	kg/m^3
k (W/(m*K))	Thermal conductivity - k [W/(m*K)]	W/(m*K)

Once there are no unassigned properties remaining, a check mark appears next to the last step in the Instructions section.

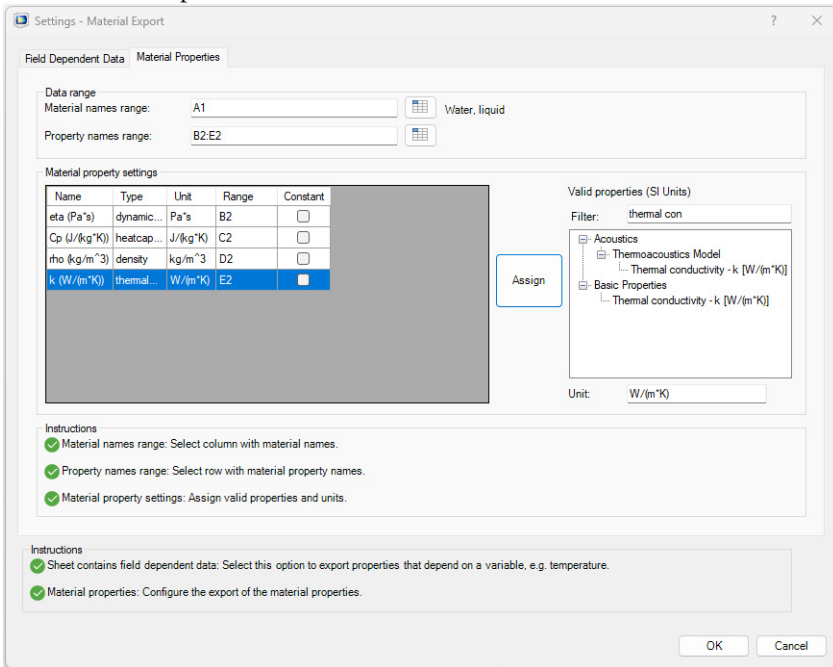

Note: Select Constant dialog to export a specific property as constant. For constant export, select the cell range of the property values in the Property name range.



14 Click OK to save the settings, and to close the dialog.

15 Note that comments now appear on the cells containing the material names and properties.

	A	B	C	D	E
1	Water, liquid				
2	T (K)	eta (Pa*s)	Cp (J/(kg*K))	rho (kg/m^3)	k (W/(m*K))
3	273.15	0.0017915	4216.2779	1003.9209	0.55623
4	278.15	0.0015356	4206.8543	1003.0467	0.56642
5	283.15	0.0013248	4198.8844	1002.0375	0.57614

Exporting the Material Properties

Now that you have defined the material export settings for data stored in the workbook you can finalize the export to a new material library.

- 1 Go to the Materials worksheet.
- 2 To create a material library using the selected data in the spreadsheet, click New  in the Material Export group. This automatically starts a COMSOL Multiphysics server, if not already started, and the Save Material Library window.
- 3 In the Save Material Library window browse to the folder `.comsol/v64/materials` available in the user local directory.
- 4 In File name text field, enter a name for the material library. For this example, enter `My_Materials` and click Save.
- 5 Now go to the Water, liquid worksheet.
- 6 To append the material to the library created previously, click the Append () button.
- 7 In the Open Material Model window, select `My_Materials.mph` and click Open. The next time you start the COMSOL Desktop, the Material Browser will be automatically updated with the new library saved in the `.comsol/v64/materials` folder.

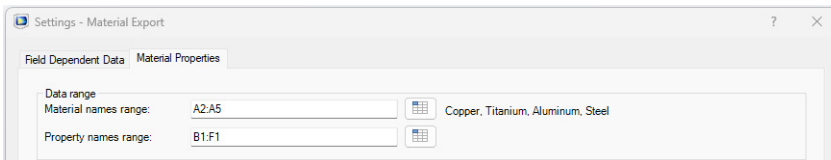

Loading and Saving Excel® Files from the COMSOL Desktop®



LiveLink™ for Excel® adds the Excel XLSX format in the list of supported file formats for loading and saving data while setting up applications in the COMSOL Desktop. Feature nodes that support this functionality include Parameters, Variables, Interpolation functions, Piecewise functions, Parametric Sweep, the continuation section of the Stationary node, and the auxiliary sweep section. The data formats used by these features may differ. The easiest way to find out how to organize data in the Excel file is to enter some settings in a table in the COMSOL Desktop and save it to the Excel format.

In the current example, you will modify an existing model by importing model definitions from an Excel file. You will start by loading the model, Electrical Heating in a Busbar, from the COMSOL Multiphysics application library. This model analyzes the resistive heating of a busbar designed to conduct direct current. For details, see the booklet *Introduction to COMSOL Multiphysics*.

The tutorial walks you through how to import Excel files for three feature nodes, each with a different requirement on the data format. The feature nodes that are covered are:

- Parameters
- Interpolation function
- Continuation section of the Stationary study step node

Opening the Model

- 1 If it is not already open, start a new COMSOL Desktop. From the File toolbar, select Application Libraries .
- 2 In the Application Libraries window, choose COMSOL Multiphysics>Multiphysics>busbar and click Open .

Importing Parameters from Excel®

1 In the Model Builder, find and expand the Global Definitions node, then select the Parameters 1 node.

As you can see, the model already contains some parameters in the table.

In order to illustrate the different import capabilities we will replace this list by a new one.

Name	Expression	Value	Description
L	9[cm]	0.09 m	Length
rad_1	6[mm]	0.006 m	Bolt radius
tbb	5[mm]	0.005 m	Thickness
wbb	5[cm]	0.05 m	Width
mh	3[mm]	0.003 m	Maximum element size
htc	5[W/m^2/K]	5 W/(m^2·K)	Heat transfer coefficient
Vtot	20[mV]	0.02 V	Applied voltage

2 First clear the table by pressing the Clear Table button to prevent multiple parameters with the same name.

3 To import parameters from an Excel file to the list, click Load from File located below the table.

4 In the Load from File dialog, select the Microsoft Excel Workbook (*.xlsx) file type and navigate to the COMSOL installation directory. In the folder applications/LiveLink_for_Excel/Tutorials, select the file busbar_1lexcel_data.xlsx and click Open.

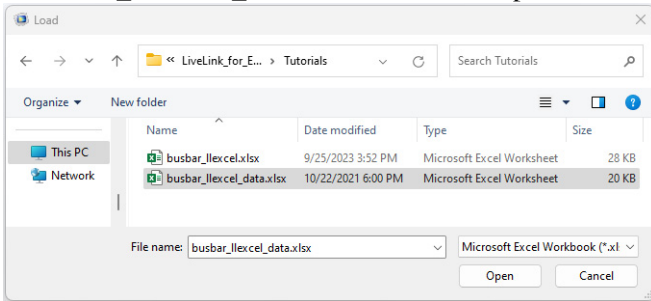

This opens the Excel Load dialog.

The workbook contains a list of parameters in the Parameters worksheet, which is shown in the figure to the right.

	A	B	C
1	Name	Expression	Description
2	L	9[cm]	Length of busbar
3	rad_1	6[mm]	Radius of bolts
4	tbb	5[mm]	Thickness of busbar
5	wbb	10[cm]	Width of busbar
6	mh	6[mm]	Mesh control
7	Vtot	20[mV]	Voltage

If you compare this list to the parameters defined in the model, you can see that the heat transfer coefficient is not included. The busbar width value is also

different; 10 cm in the Excel file instead of 5 cm in the model.

- 5 In the Excel Load dialog, specify the sheet and cell range to use for the import. Enter **Parameters** in the Sheet text field, and enter **A3** in the Range text field to import all parameters from the third row. Note that the range should not include the column headers.

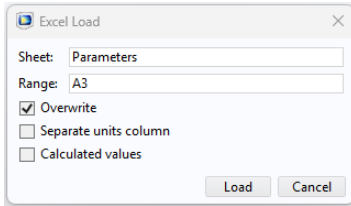

- 6 Click Load. The parameter list is now imported to the model.

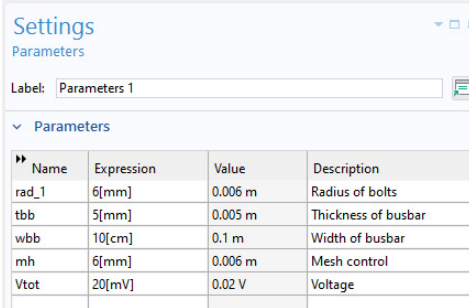
The image shows the 'Settings Parameters' window. The 'Label' field is set to 'Parameters 1'. Below it, a table lists the imported parameters.

Name	Expression	Value	Description
rad_1	6[mm]	0.006 m	Radius of bolts
tbb	5[mm]	0.005 m	Thickness of busbar
wbb	10[cm]	0.1 m	Width of busbar
mh	6[mm]	0.006 m	Mesh control
Vtot	20[mV]	0.02 V	Voltage

To keep the existing parameters in a model unmodified by the import, you can clear the Overwrite checkbox in the Excel Load dialog before the import. In this case, imported parameters will be appended to the table and you will need to resolve any conflicts between similar parameter names yourself.

Note: COMSOL does not support multiple parameters with the same name. Only the first parameter definition, from the top, is kept in the table if multiple entries with the same name are present when you leave the Parameters node.

- 7 In the Home toolbar, click Parameters Π and select Add>Parameters.
- 8 In Parameters 2 Settings window, click Load from File .
- 9 In the Load from File dialog, select the Microsoft Excel Workbook (*.xlsx) file type and navigate to the COMSOL installation directory. In the folder applications/LiveLink_for_Excel/Tutorials, select the file busbar_11excel_data.xlsx and click Open.
- 10 In the Excel Load dialog, specify the sheet and cell range to use for the import. Enter **Parameters** in the Sheet text field, and enter **A2:C2** in the Range text field to import only the parameter at the second row (L, the length of the busbar).

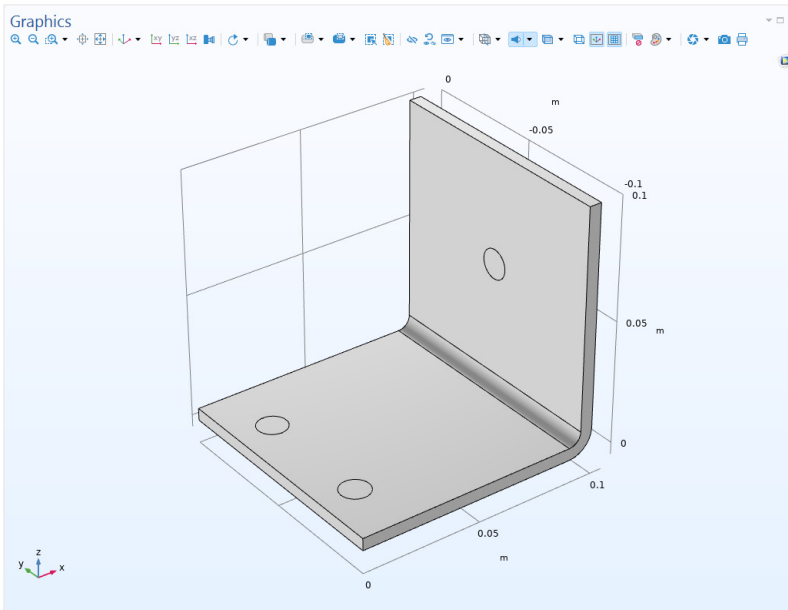

Here we use a second parameters node only to show how you can link a specify group of parameters with a spreadsheet when running a model from within Excel. See the section [Retrieving and Updating Model Parameters](#).

- 1 In the Geometry toolbar, click Build All  and go to Geometry 1 node to visualize the geometry with the new parameters value.



Defining an Interpolation Function Using an Excel® File

You will now import data stored in a workbook to define an interpolation function in the model. The function defines the temperature dependency of the heat transfer coefficient between the busbar and the surrounding air.

- 1 In the Home toolbar, click Functions  in the Definitions group. Under the Local section, select Interpolation . On Linux and Mac, the Home toolbar refers to the specific set of controls near the top of the Desktop.
- 2 In the Settings window, under the Definition section, in the Function name text field, enter `htc`.
- 3 Now click Load from File .

- In the Load from File dialog, select the Microsoft Excel Workbook (*.xlsx) file type, and navigate to the COMSOL installation directory. In the folder applications/LiveLink_for_Excel/Tutorials, select the file busbar_1lexcel_data.xlsx, then click Open.

The interpolation data is stored in the workbook in a worksheet named $htc(T)$. The temperature values and the corresponding heat transfer coefficient values are defined in two columns, as can be seen in the figure to the right.

	A	B
1	T[K]	htc[W/m ² /K]
2	293	5.0136
3	303	8.5
4	313	9.3272
5	323	9.8918
6	333	10.3303
7	343	10.6921
8	353	11.0012
9	363	11.2717
10	373	11.5123
11	383	11.729
12	393	11.9262

- In the Settings window for Interpolation enter $htc(T)$ in the Sheet text field.
- In the Range field enter A2.
- To import the data, click Load.

The interpolation table is filled using the data stored in the Excel file.

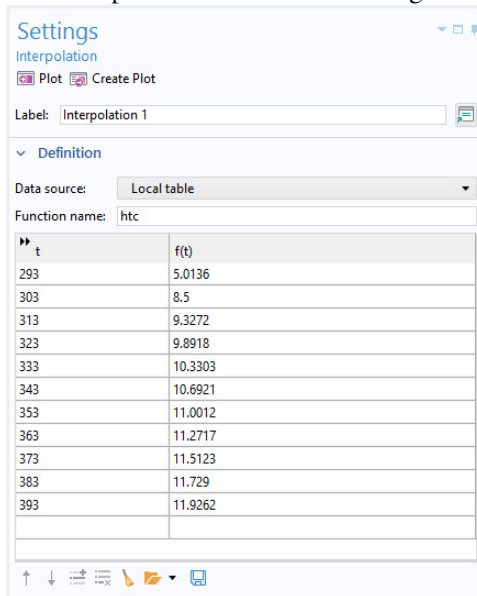

- Locate the section, Interpolation and Extrapolation. In the Interpolation list, select Piecewise cubic.

9 Locate the section, Units. In the Function text field enter $W/(m^2 \cdot K)$. In the Arguments text field enter K.

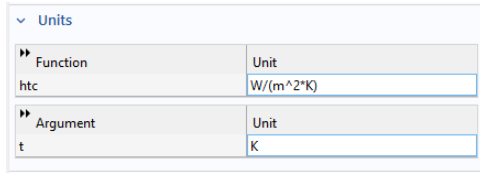

10 To display the interpolation curve, click Plot  .

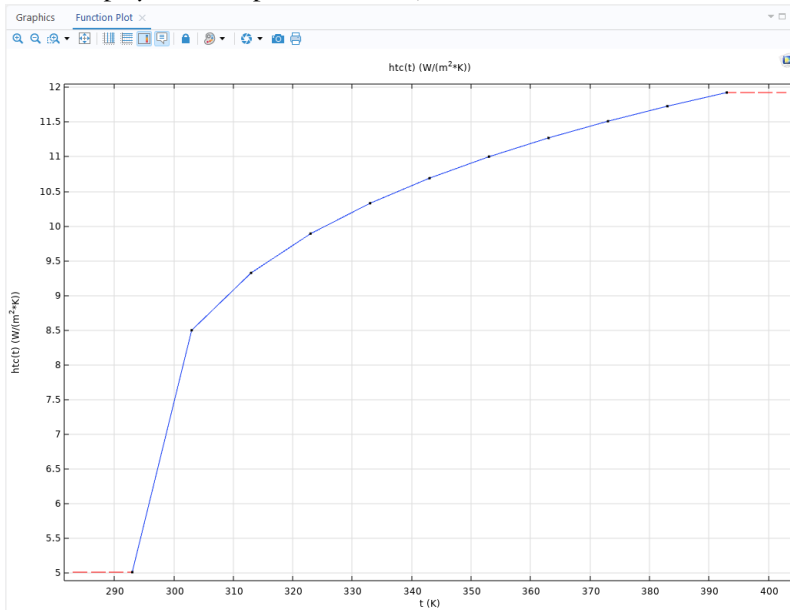

Now continue with changing the model settings to use the newly defined function for the heat transfer coefficient in the heat flux boundary condition.

- 11 In the Model Builder, under the Component 1 node, expand the Heat Transfer in Solids nodes and then click Heat Flux 1.
- 12 In the Settings window for Heat Flux replace the expression in the Heat transfer coefficient text field with $htc(T)$.

Importing a Sweep List

With the use of an auxiliary sweep, you can solve the model for a range of parameter values, which enables you to vary, for example, a boundary condition. Here, solve the model for different values of the applied voltage V_{tot} , imported from the same Excel file used previously.

- 1 In the Model Builder, expand Study 1 and click Step 1: Stationary.
- 2 In the Settings window for Stationary expand Study Extensions.
- 3 Under the Study Extensions section, select Auxiliary sweep and then click the Load from File  button.
- 4 In the Load from File dialog, select the Microsoft Excel Workbook (*.xlsx) file type, and navigate to the COMSOL Multiphysics installation directory. In the folder applications/LiveLink_for_Excel/Tutorials, select the file busbar_11excel_data.xlsx, then click Open.

The continuation parameter list can be found in the worksheet, Voltage, in the file.

	A	B	C
1	Continuation parameter	Parameter value list	Unit
2	Vtot	5 10 20 30 40	mV

- 5 In the Excel Load dialog, enter Voltage and A2, in the Sheet and Range text fields, respectively.

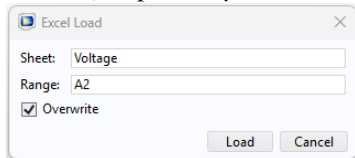



- 6 Finally, click Load.

The study is now set up to compute the solution for each of the specified voltage values: 5 mV, 10 mV, 20 mV, 30 mV, and 40 mV.



Computing and Displaying the Solution

As a last step, compute the solution that reflects the changes you have applied to the model. But before you will add a maximum operator for postprocessing purpose and a Parametric Sweep node to prepare the model to show how you can link parametric and auxiliary sweep with a spreadsheet when running a model from within Excel. See the section [Running Model in Sweep](#).

- 1 In the Definitions toolbar, click Nonlocal Couplings  and select Maximum **MAX**.
- 2 In the Maximum 1 settings windows, select Domain 1.
- 3 In the Study toolbar, click Parametric Sweep .
- 4 In the Parametric Sweep node window settings, click Add **+** and select the parameter wbb (Width of busbar). In the Parameter value list text field enter 10e-2.

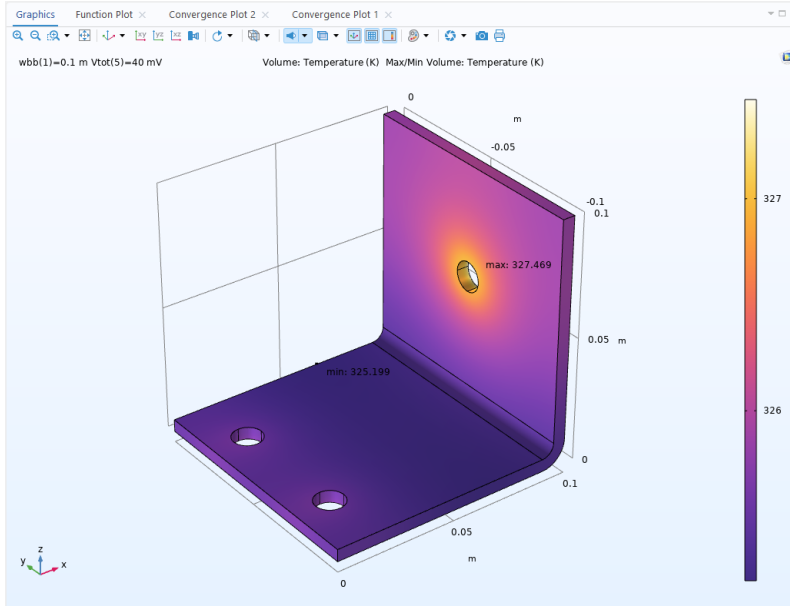
- 5 In the Study 1 node Settings window, under Study Settings, clear Generate default plots to avoid duplicate plot groups when computing the solution with the parametric sweep.
- 6 In the Study toolbar, click Compute  .
- 7 To view the temperature distribution in the busbar only, you need to add a selection to the solution dataset. Under Results > Datasets, right-click Study 1/ Parametric Solutions 1 and select Selection.
- 8 In the Settings window for Selection set the Geometric entity level to Domain, and select Domain 1.
- 9 To see the temperature distribution in the busbar for the last parameter value (40 mV), select the Temperature (ht) node. In the 3D plot Group settings window, in the Dataset list, select Study 1/parametric Solutions 1.
- 10 Expand the Temperature (ht) node, and select Surface. In the Surface node settings windows, expands the Range section and clear Manual color range.



- 11 In the Results toolbar click 1D Plot Group  .
- 12 In the 1D Plot Group settings window, in Dataset list select Study 1/Parametric Solutions 1.
- 13 In the 1D Plot Group 6 toolbar, click Global  and in the Global settings window, enter $\max_{op1}(T)$ in the Expression field.
- 14 Click Plot  .