

Bracket — Frequency-Response Analysis

Introduction

A frequency response analysis solves for the linear steady-state response of a structure when subjected to harmonic loads. The problem is solved in the frequency domain and you can prescribe a range of frequencies at which to compute the response.

In this example, you learn how to perform a frequency response analysis of a structure under only harmonic loads, and also how to perform a frequency response analysis of a prestressed structure.

It is recommended that you review the *Introduction to the Structural Mechanics Module*, which includes background information and discusses the `bracket_basic.mph` model relevant to this example.



Read more about frequency-domain studies in:

- In the *Structural Mechanics Modeling* chapter of the *Structural Mechanics Module User's Guide*:
 - *Frequency-Domain Analysis*
 - *Mode Superposition*
 - *Harmonic Perturbation*
- [COMSOL Blog: Frequency Response of Mechanical Systems](#)

Model Definition

This model is an extension of the model example described in the section “The Fundamentals: A Static Linear Analysis” in the *Introduction to the Structural Mechanics Module*.

The geometry is shown in [Figure 1](#).

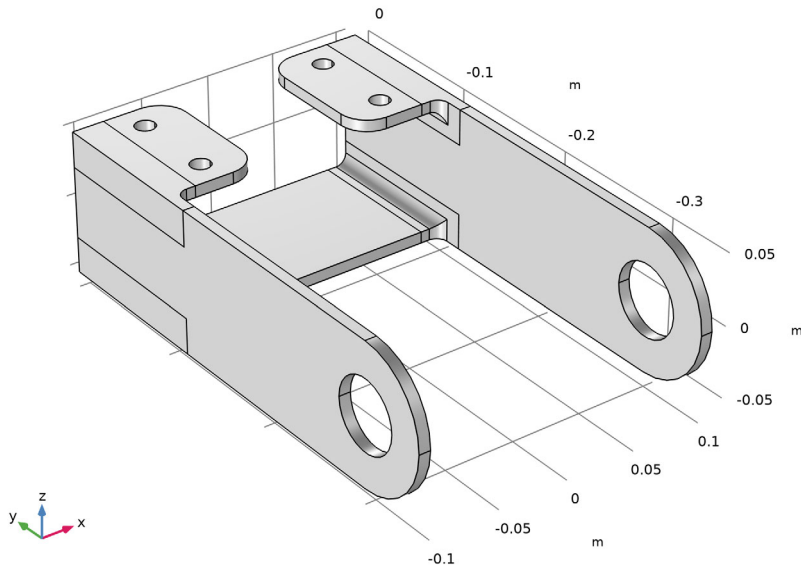

Figure 1: Bracket geometry.

You study two load cases. In the first case, a harmonic load in the X direction, with a total amplitude of 25 N, is applied to the boundaries of the bracket holes. The load is equally divided between the two arms.

The second load case consists of a combination of a static preload and the same harmonic perturbation.

An eigenfrequency analysis of this structure is performed in the tutorial [Bracket — Eigenfrequency Analysis](#). It shows that the first natural frequency is about 114 Hz. For the prestressed case, the eigenfrequency solution shows that the first resonance frequency is about 105 Hz when the arm is under a compressive load, and about 128 Hz when the arm is under a tensile load. In order to capture the resonance peaks properly, you can refine the frequency stepping around these values.

Results and Discussion

An important property of frequency domain studies is that the results are complex-valued. During result evaluation, you must be careful about whether you present values at a certain phase angle, peak values of the cycle, or RMS values.

The default plot in a frequency-domain analysis shows the variable `<phys>.misesGp_peak`. This is a special variable that, in each point, contains the maximum von Mises stress over the whole cycle. The standard von Mises stress variables contain the stress at the current phase angle. This may be far from the peak stress, if there are significant phase shifts. In [Figure 2](#), the stress at the last computed frequency, 750 Hz is shown. More interesting is to study the results at 114 Hz at which the first natural frequency is located. This is shown in [Figure 3](#). Here, the peak value is around 115 MPa, to be compared with 1 MPa in the previous case.

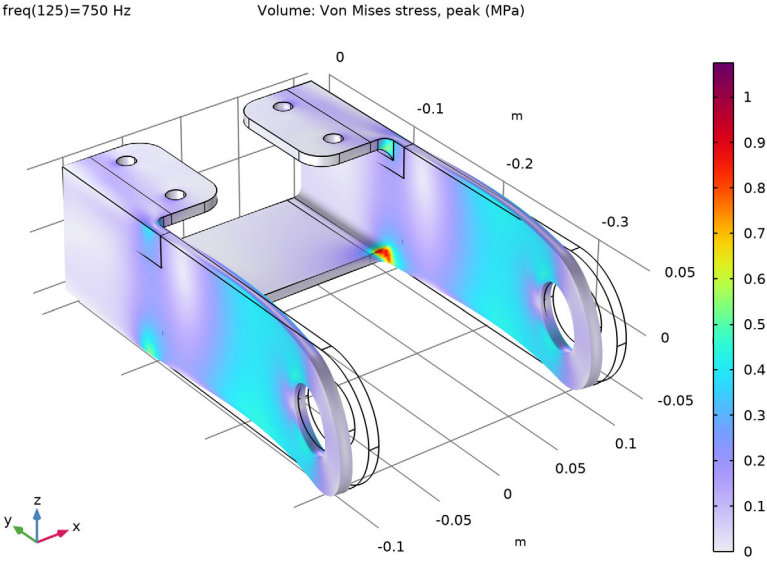

Figure 2: von Mises stress at 750 Hz.

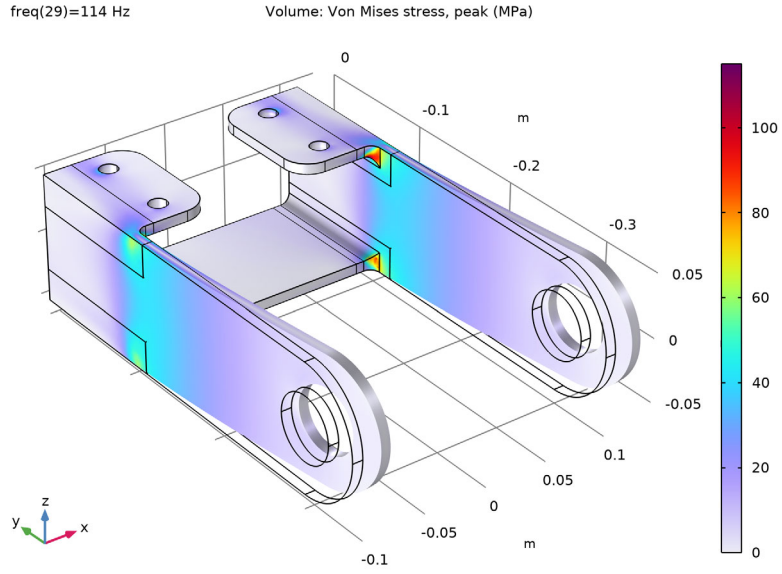

Figure 3: von Mises stress at 114 Hz.

Figure 4 shows the root mean square (RMS) of the displacement at the tip of the arms of the bracket around the first resonance for both the pure harmonic load case and the combined harmonic and static load cases.

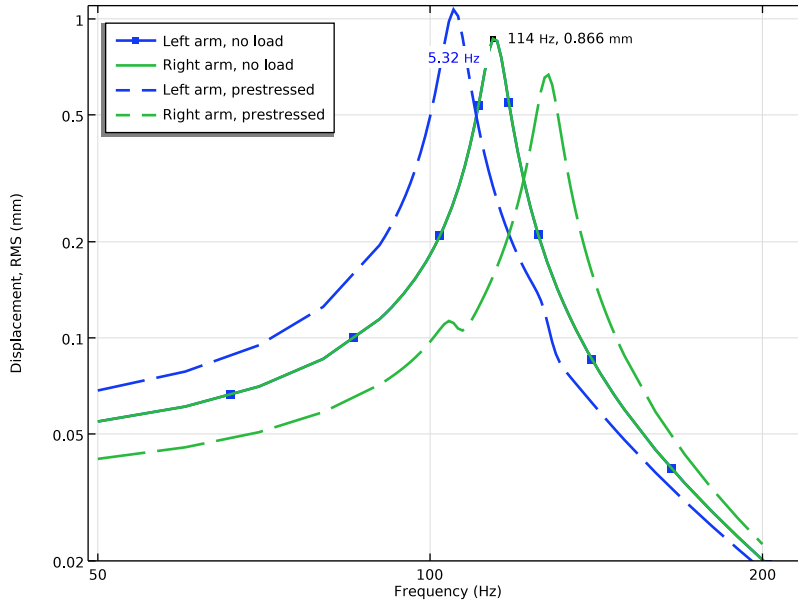

Figure 4: RMS of the displacement at the tip of the left (blue) and right (green) arms. The results without prestress are shown with solid lines, while dashed lines are used for a case with a combination of static and harmonic loads.

The curves show resonance peaks around 114 Hz for the unloaded structure in both bracket arms and a frequency shift for the loaded structure. These results are in agreement with the values predicted by the eigenfrequency solution. The curves for the left and right arms coincide as long as there is no prestress.

You can also verify that the deformation remains small even around the resonance frequency. Thus, the linearity assumption necessary for frequency-domain studies is fulfilled.

Figure 5 shows the phase of the x -displacement at the tips of both arms.

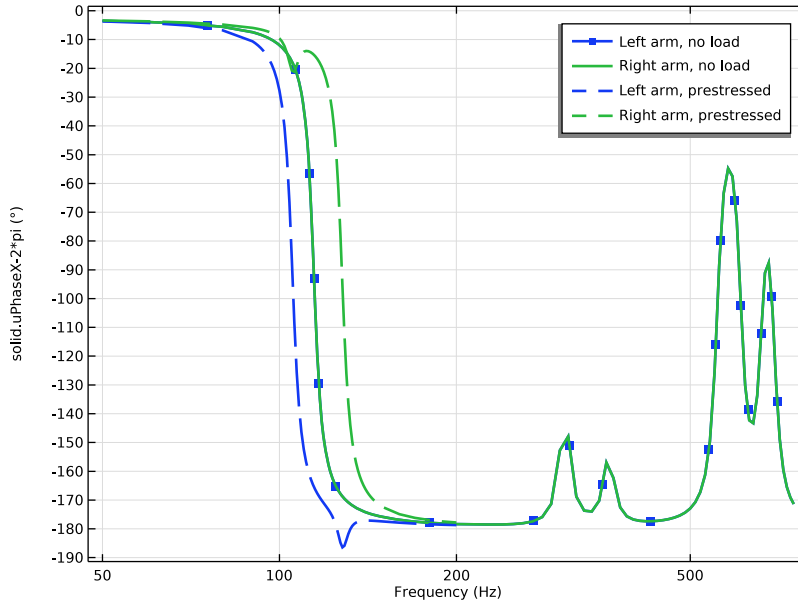

Figure 5: Phase of x -displacement at the tips of the arms.

Note the smooth transition where the displacement is in phase with the load at lower frequencies and in counterphase for higher frequencies. This is an effect of the damping, where a 5% loss factor is used. The solution for the prestressed case shows interesting properties, where the phase flips at different frequencies in each arm. This can be interpreted so that the two arms move synchronously for low and high frequencies, but against each other for intermediate frequencies.

In Figure 6 and Figure 7, the perturbation of the von Mises stress is shown at 107 Hz and 128 Hz. This result is the linearized deviation from the constant stress caused by the static preload, and thus the values can be both positive and negative. Each arm dominates the response in the vicinity of its own eigenfrequency.

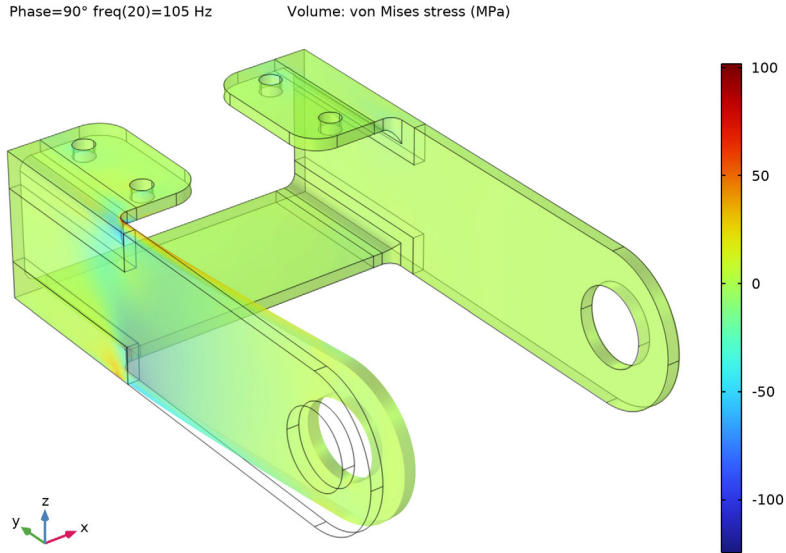

Figure 6: Perturbation in von Mises stress at first eigenfrequency, 105 Hz.

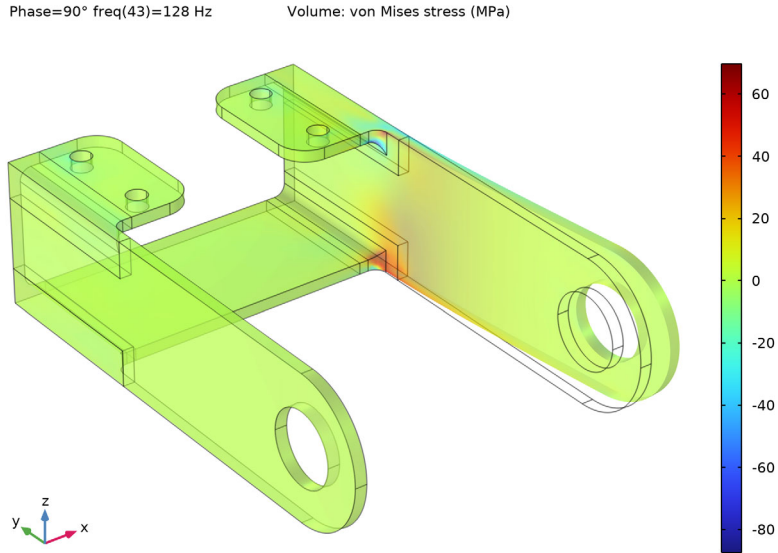

Figure 7: Perturbation in von Mises stress at second eigenfrequency, 128 Hz.

It is possible to display the variation in time domain of any result by using the phase angle as parameter for graphs. In [Figure 8](#), the variation of displacement in the direction of the load is shown at two frequencies close to the two first eigenfrequencies. Note that the horizontal axis has phase angle as unit. This is essentially a scaled time.

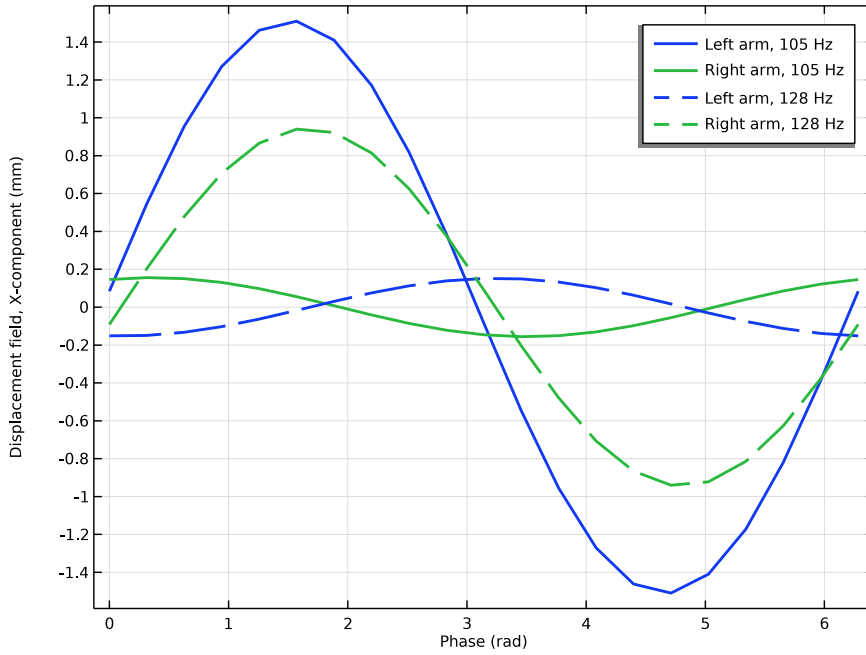

Figure 8: Displacement history at two locations and two frequencies.

Quantities that are linear functions of the solution will share the property of being time harmonic. This would, for example, be true for a single stress tensor component, but it is not true for equivalent stresses. This is illustrated in Figure 9, where the von Mises stress is shown for studies with and without prestress.

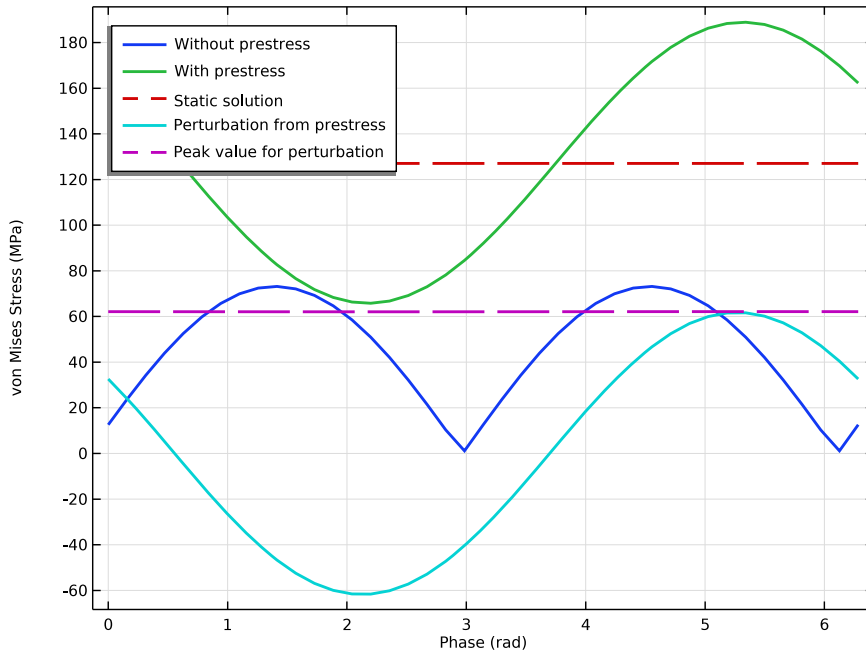

Figure 9: Various representations of the von Mises stress in a point at resonance frequency.

Since the von Mises stress by definition is always positive, the result for the study without prestress looks similar to the absolute value of a harmonic function. When the prestress is added, then the von Mises stress is fully harmonic, since it can vary around the static prestress while still being positive.

Figure 10 shows the RMS of the x -component of the velocity of the arm of the bracket over the whole solved frequency range for the analysis without prestress as a one-third octave band plot. The band centered at 630 Hz shows a local maximum related to the second flexural mode of the arms.

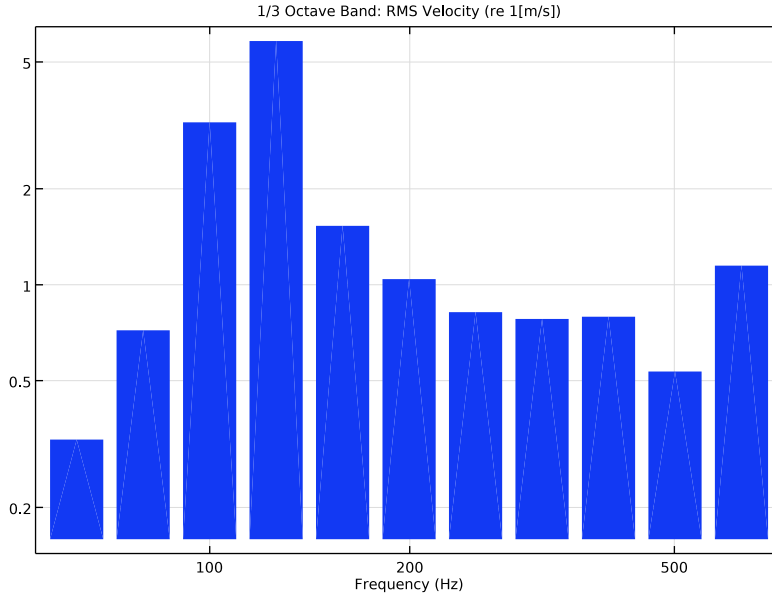

Figure 10: One-third octave band plot of the x-component of the velocity at the arm tip.

Notes About the COMSOL Implementation

For structural mechanics physics interfaces in COMSOL Multiphysics, there are six predefined study types available for frequency-response analysis: **Frequency Domain**; **Frequency Domain Modal**; **Frequency Domain, Prestressed**; **Frequency Domain, Prestressed, Modal**; **Frequency Domain, Modal Reduced-Order Model**; and **Frequency Domain, AWE Reduced-Order Model**;

The modal analysis uses the modal solver to compute the frequency response. This analysis type speeds up the computation significantly when compared to the regular frequency-domain analysis if the number of frequencies is large. In this example, the modal solver is used in the first study, and the direct solver in the second study. This is purely for comparison. If the modal solver had been selected also for the second study, it would run more than 10 times faster.

Use the prestressed frequency-response analysis when a structure is subjected to both static and harmonic loads, and the stiffness induced by the static load case can affect the structural response to the harmonic load.

When working with results from a prestressed analysis, there are several options for how to evaluate the solution. You can, for example, choose to display the total solution or only the perturbation part. The five graphs in [Figure 9](#) are created using the settings summarized in [Table 1](#).

TABLE 1: GRAPH SETTINGS

GRAPH LEGEND	STUDY	FREQUENCY	VARIABLE	EXPRESSION EVALUATED FOR	COMPUTE DIFFERENTIAL
Without prestress	Study 1	114 Hz	solid.mises	N/A	N/A
With prestress	Study 2	107 Hz	solid.mises	Total instantaneous solution	N/A
Static solution	Study 2	Any	solid.mises	Static solution	N/A
Perturbation from prestress	Study 2	107 Hz	solid.mises	Harmonic Perturbation	Yes
Peak value for perturbation	Study 2	107 Hz	solid.mises_peak	Harmonic perturbation	No

Application Library path: Structural_Mechanics_Module/Tutorials/bracket_frequency

Modeling Instructions

APPLICATION LIBRARIES

- 1 From the **File** menu, choose **Application Libraries**.
- 2 In the **Application Libraries** window, select **Structural Mechanics Module > Tutorials > bracket_basic** in the tree.
- 3 Click  **Open**.

SOLID MECHANICS (SOLID)

Linear Elastic Material 1

In the **Model Builder** window, expand the **Component 1 (comp1) > Solid Mechanics (solid)** node, then click **Linear Elastic Material 1**.

Damping I

1 In the **Physics** toolbar, click  **Attributes** and choose **Damping**.

In the frequency domain you can use loss factor damping, viscous damping, or Rayleigh damping. For this example, use loss factor damping.

2 In the **Settings** window for **Damping**, locate the **Damping Settings** section.

3 From the **Damping type** list, choose **Isotropic loss factor**.

MATERIALS

Structural steel (mat1)

1 In the **Model Builder** window, expand the **Component 1 (comp1) > Materials** node, then click **Structural steel (mat1)**.

2 In the **Settings** window for **Material**, locate the **Material Contents** section.

3 In the table, enter the following settings:

Property	Variable	Value	Unit	Property group
Isotropic structural loss factor	eta_s	0.05	1	Basic

You can now apply an external harmonic load to the bracket arms.

SOLID MECHANICS (SOLID)

Boundary Load, Harmonic

1 In the **Physics** toolbar, click  **Boundaries** and choose **Boundary Load**.

2 In the **Settings** window for **Boundary Load**, type **Boundary Load, Harmonic** in the **Label** text field.

3 Locate the **Boundary Selection** section. From the **Selection** list, choose **Pin Holes**.

4 Locate the **Force** section. From the **Load type** list, choose **Total force**.

5 Specify the \mathbf{F}_{tot} vector as

25[N]	x
-------	---

To define a harmonic load in the frequency domain modal analysis, you need to mark the load as being a harmonic perturbation.

6 Right-click **Boundary Load, Harmonic** and choose **Harmonic Perturbation**.

ADD STUDY

1 In the **Home** toolbar, click  **Add Study** to open the **Add Study** window.

- 2 Go to the **Add Study** window.
- 3 Find the **Studies** subsection. In the **Select Study** tree, select **Preset Studies for Selected Physics Interfaces > Frequency Domain, Modal**.
- 4 Click the **Add Study** button in the window toolbar.
- 5 In the **Home** toolbar, click  **Add Study** to close the **Add Study** window.

STUDY 1

Step 1: Eigenfrequency

- 1 In the **Settings** window for **Eigenfrequency**, locate the **Study Settings** section.
- 2 Select the **Desired number of eigenfrequencies** checkbox. In the associated text field, type 12.

For a mode superposition, it is the undamped eigenvalues that should be used. Disable the damping in this study.
- 3 Locate the **Physics and Variables Selection** section. Select the **Modify model configuration for study step** checkbox.
- 4 In the tree, select **Component 1 (comp1) > Solid Mechanics (solid) > Linear Elastic Material 1 > Damping 1**.
- 5 Right-click and choose **Disable**.

Step 2: Frequency Domain, Modal

The frequency range will be 50 Hz–750 Hz with a refined frequency sweep step between 90 Hz and 140 Hz.

- 1 In the **Model Builder** window, click **Step 2: Frequency Domain, Modal**.
- 2 In the **Settings** window for **Frequency Domain, Modal**, locate the **Study Settings** section.
- 3 In the **Frequencies** text field, type range (50, 10, 90) range (91, 1, 149) range (150, 10, 750).
- 4 In the **Study** toolbar, click  **Compute**.

RESULTS

Stress (solid)

- 1 Click the  **Zoom Extents** button in the **Graphics** toolbar.

The default plot group shows the stress distribution on a deformed geometry for the final frequency (750 Hz). You can change the frequency for the plot evaluation in the **Parameter value** list in the settings for the plot group.

Volume 1

- 1 In the **Model Builder** window, expand the **Stress (solid)** node, then click **Volume 1**.
- 2 In the **Stress (solid)** toolbar, click  **Plot**.



Stress (solid)

Plot the stresses at 114 Hz too.

- 1 In the **Model Builder** window, click **Stress (solid)**.
- 2 In the **Settings** window for **3D Plot Group**, locate the **Data** section.
- 3 From the **Parameter value (freq (Hz))** list, choose **114**.
- 4 In the **Stress (solid)** toolbar, click  **Plot**.

Plot the root mean square of the displacement at the tip of the bracket arms.

Displacement, RMS

- 1 In the **Results** toolbar, click  **ID Plot Group**.
- 2 In the **Settings** window for **ID Plot Group**, type **Displacement, RMS** in the **Label** text field.
- 3 Locate the **Plot Settings** section.
- 4 Select the **x-axis label** checkbox. In the associated text field, type **Frequency (Hz)**.
Frequency response curves are often presented using a logarithmic scale.
- 5 Click the  **x-Axis Log Scale** button in the **Graphics** toolbar.
- 6 Click the  **y-Axis Log Scale** button in the **Graphics** toolbar.

Point Graph 1

- 1 Right-click **Displacement, RMS** and choose **Point Graph**.
- 2 Select **Point 1** only.
- 3 In the **Settings** window for **Point Graph**, locate the **y-Axis Data** section.
- 4 In the **Expression** text field, type `solid.disp_rms`.
- 5 Click to expand the **Coloring and Style** section. From the **Width** list, choose **2**.
- 6 Find the **Line markers** subsection. From the **Marker** list, choose **Point**.
- 7 From the **Positioning** list, choose **Interpolated**.
- 8 In the **Number** text field, type **20**.
- 9 Click to expand the **Legends** section. Select the **Show legends** checkbox.
- 10 From the **Legends** list, choose **Manual**.

11 In the table, enter the following settings:

Legends

Left arm, no load

Displacement, RMS

- 1 In the **Model Builder** window, click **Displacement, RMS**.
- 2 In the **Settings** window for **ID Plot Group**, click to expand the **Title** section.
- 3 From the **Title type** list, choose **None**.

Point Graph 2

- 1 Right-click **Displacement, RMS** and choose **Point Graph**.
- 2 Select Point 109 only.
- 3 In the **Settings** window for **Point Graph**, locate the **y-Axis Data** section.
- 4 In the **Expression** text field, type `solid.disp_rms`.
- 5 Locate the **Coloring and Style** section. From the **Width** list, choose **2**.
- 6 Locate the **Legends** section. Select the **Show legends** checkbox.
- 7 From the **Legends** list, choose **Manual**.
- 8 In the table, enter the following settings:

Legends

Right arm, no load

- 9 In the **Displacement, RMS** toolbar, click  **Plot**.



Add a marker showing the peak value, and at which frequency it occurs.

Graph Marker 1



- 1 In the **Model Builder** window, right-click **Point Graph 1** and choose **Graph Marker**.
- 2 In the **Settings** window for **Graph Marker**, locate the **Display** section.
- 3 From the **Display** list, choose **Max**.
- 4 Locate the **Text Format** section. In the **Precision** text field, type **3**.
- 5 Select the **Show x-coordinate** checkbox.
- 6 Select the **Include unit** checkbox.
- 7 Click to expand the **Coloring and Style** section. From the **Anchor point** list, choose **Middle left**.
- 8 In the **Displacement, RMS** toolbar, click  **Plot**.

Generate an 1/3 octave band plot of the RMS of the x-component of the velocity at the tip of the left arm of the bracket.

Velocity, X-component RMS 1/3 Octave

- 1 In the **Results** toolbar, click  **ID Plot Group**.
- 2 In the **Settings** window for **ID Plot Group**, type Velocity, X-component RMS 1/3 Octave in the **Label** text field.
- 3 Locate the **Title** section. From the **Title type** list, choose **Manual**.
- 4 In the **Title** text area, type 1/3 Octave Band: RMS Velocity (re 1[m/s]).
- 5 Locate the **Axis** section. Select the **x-axis log scale** checkbox.
- 6 Select the **y-axis log scale** checkbox.
- 7 Click the  **Show More Options** button in the **Model Builder** toolbar.
- 8 In the **Show More Options** dialog, in the tree, select the checkbox for the node **Results > All Plot Types**.
- 9 Click **OK**.

Octave Band 1

- 1 In the **Velocity, X-component RMS 1/3 Octave** toolbar, click  **More Plots** and choose **Octave Band**.
- 2 Select Point 2 only.
- 3 In the **Settings** window for **Octave Band**, locate the **y-Axis Data** section.
- 4 In the **Expression** text field, type `abs(solid.u_tx)/sqrt(2)`.
- 5 From the **Expression type** list, choose **General (non-dB)**.
- 6 In the **Reference expression** text field, type 1[m/s].
- 7 Locate the **Plot** section. From the **Band type** list, choose **1/3 octave**.
- 8 In the **Velocity, X-component RMS 1/3 Octave** toolbar, click  **Plot**.

You will now consider a static load applied to the bracket and perform a prestressed frequency domain analysis.

ADD STUDY

- 1 In the **Home** toolbar, click  **Add Study** to open the **Add Study** window.
- 2 Go to the **Add Study** window.
- 3 Find the **Studies** subsection. In the **Select Study** tree, select **Preset Studies for Selected Physics Interfaces > Frequency Domain, Prestressed**.
- 4 Click the **Add Study** button in the window toolbar.

5 In the **Home** toolbar, click  **Add Study** to close the **Add Study** window.

GLOBAL DEFINITIONS

Parameters 1

1 In the **Settings** window for **Parameters**, locate the **Parameters** section.

2 In the table, enter the following settings:

Name	Expression	Value	Description
Fh	10[kN]	10000 N	Force per hole

SOLID MECHANICS (SOLID)

Boundary Load, Prestress

1 In the **Physics** toolbar, click  **Boundaries** and choose **Boundary Load**.

Apply a boundary load to the bracket holes.

2 In the **Settings** window for **Boundary Load**, type **Boundary Load, Prestress** in the **Label** text field.

3 Locate the **Boundary Selection** section. From the **Selection** list, choose **Pin Holes**.

4 Locate the **Coordinate System Selection** section. From the **Coordinate system** list, choose **Boundary System 1 (sys1)**.

5 Locate the **Force** section. Specify the \mathbf{f}_A vector as

0	t1
0	t2
load(-p0,Z,Y-PinHoleY)*(X*(Y-PinHoleY)<0)	n

The default boundary system is in the deformed configuration. This would make the load behave as a follower load when used in a geometrically nonlinear context. Change to a fixed coordinate system.

DEFINITIONS

Boundary System 1 (sys1)

1 In the **Model Builder** window, expand the **Component 1 (comp1) > Definitions** node, then click **Boundary System 1 (sys1)**.

2 In the **Settings** window for **Boundary System**, locate the **Settings** section.

3 From the **Frame** list, choose **Reference configuration**.

STUDY 2

Step 2: Frequency-Domain Perturbation

- 1 In the **Model Builder** window, under **Study 2** click **Step 2: Frequency-Domain Perturbation**.
- 2 In the **Settings** window for **Frequency-Domain Perturbation**, locate the **Study Settings** section.
- 3 In the **Frequencies** text field, type `range(50,10,90) range(91,1,149) range(150,10,200)`.
- 4 In the **Study** toolbar, click  **Compute**.

RESULTS

- 1 Click the  **Zoom Extents** button in the **Graphics** toolbar.

You have previously created a point graph plot for the unloaded case. Add a new point graph plot to the same figure but use the dataset of the second load case.

Point Graph 1, Point Graph 2

- 1 In the **Model Builder** window, under **Results > Displacement, RMS**, Ctrl-click to select **Point Graph 1** and **Point Graph 2**.
- 2 Right-click and choose **Duplicate**.

Point Graph 3

- 1 In the **Settings** window for **Point Graph**, locate the **Data** section.
- 2 From the **Dataset** list, choose **Study 2/Solution 3 (sol3)**.
- 3 Locate the **Coloring and Style** section. From the **Color** list, choose **Cycle (reset)**.
- 4 Find the **Line style** subsection. From the **Line** list, choose **Dashed**.
- 5 Find the **Line markers** subsection. From the **Marker** list, choose **None**.
- 6 Locate the **Legends** section. In the table, enter the following settings:

Legends

Left arm, prestressed

Estimate the damping from the response using the full width at half maximum (FWHM) method. Since this method is based on a power definition, the corresponding level for an amplitude variable is the peak value divided by $\sqrt{2}$. Note that a table containing the damping values is automatically generated.

Graph Marker 1

- 1 In the **Model Builder** window, expand the **Point Graph 3** node, then click **Graph Marker 1**.

- 2 In the **Settings** window for **Graph Marker**, locate the **Display** section.
- 3 From the **Display mode** list, choose **Bandwidth**.
- 4 From the **Cutoff mode** list, choose **Relative to peak**.
- 5 Locate the **Coloring and Style** section. From the **Color** list, choose **Blue**.
- 6 In the **Displacement, RMS** toolbar, click  **Plot**.

Point Graph 4

- 1 In the **Model Builder** window, under **Results** > **Displacement, RMS** click **Point Graph 4**.
- 2 In the **Settings** window for **Point Graph**, locate the **Data** section.
- 3 From the **Dataset** list, choose **Study 2/Solution 3 (sol3)**.
- 4 Locate the **Coloring and Style** section. Find the **Line style** subsection. From the **Line** list, choose **Dashed**.
- 5 Locate the **Legends** section. In the table, enter the following settings:

Legends
Right arm, prestressed

- 6 In the **Displacement, RMS** toolbar, click  **Plot**.

Displacement, RMS

- 1 In the **Model Builder** window, click **Displacement, RMS**.
- 2 In the **Settings** window for **ID Plot Group**, locate the **Axis** section.
- 3 Select the **Manual axis limits** checkbox.
- 4 In the **x minimum** text field, type 49.
- 5 In the **x maximum** text field, type 220.
- 6 In the **y minimum** text field, type 0.02.
- 7 In the **y maximum** text field, type 1.1.
- 8 Locate the **Legend** section. From the **Position** list, choose **Upper left**.
- 9 In the **Displacement, RMS** toolbar, click  **Plot**.

Volume 1

- 1 In the **Model Builder** window, expand the **Stress (solid) I** node, then click **Volume 1**.
- 2 In the **Settings** window for **Volume**, locate the **Expression** section.
- 3 In the **Expression** text field, type `solid.misesGp`.

- 4 Locate the **Coloring and Style** section. From the **Color table** list, choose **Rainbow**.





What is shown here is the deviation from the prestress value. This is why the von Mises stress can be negative.

Stress (solid), Prestressed

- 1 In the **Model Builder** window, expand the **Results > Datasets** node, then click **Results > Stress (solid) 1**.
- 2 In the **Settings** window for **3D Plot Group**, type **Stress (solid), Prestressed** in the **Label** text field.

Exactly at a resonance, there will be a phase shift of 90 degrees between load and displacement. In order to see the highest stresses, it is necessary to plot the results at another phase angle.
- 3 Locate the **Phase** section. From the **Solution at angle (phase)** list, choose **Manual**.
- 4 In the **Phase** text field, type 90.

Investigate the stress distribution around the resonances.

- 5 Locate the **Data** section. From the **Parameter value (freq (Hz))** list, choose **I05**.
- 6 Click the  **Transparency** button in the **Graphics** toolbar.
- 7 Click the  **Show Grid** button in the **Graphics** toolbar.
- 8 Click the  **Zoom Extents** button in the **Graphics** toolbar.
- 9 From the **Parameter value (freq (Hz))** list, choose **I28**.
- 10 In the **Stress (solid), Prestressed** toolbar, click  **Plot**.

Now plot the phase shift with respect to the applied load phase.

Displacement Phase, X Component

- 1 In the **Model Builder** window, right-click **Displacement, RMS** and choose **Duplicate**.
- 2 In the **Model Builder** window, click **Displacement, RMS 1**.
- 3 In the **Settings** window for **ID Plot Group**, type **Displacement Phase, X Component** in the **Label** text field.
- 4 Click the  **y-Axis Log Scale** button in the **Graphics** toolbar.
- 5 Locate the **Axis** section. Clear the **Manual axis limits** checkbox.
- 6 Locate the **Legend** section. From the **Position** list, choose **Upper right**.

Point Graph 1

- 1 In the **Model Builder** window, click **Point Graph 1**.
- 2 In the **Settings** window for **Point Graph**, locate the **y-Axis Data** section.

- 3 In the **Expression** text field, type `solid.uPhaseX-2*pi`.
- 4 From the **Unit** list, choose °.

Graph Marker 1

- 1 In the **Model Builder** window, expand the **Point Graph 1** node.
- 2 Right-click **Graph Marker 1** and choose **Delete**.

Point Graph 2

- 1 In the **Model Builder** window, under **Results > Displacement Phase, X Component** click **Point Graph 2**.
- 2 In the **Settings** window for **Point Graph**, locate the **y-Axis Data** section.
- 3 In the **Expression** text field, type `solid.uPhaseX-2*pi`.
- 4 From the **Unit** list, choose °.

Point Graph 3

- 1 In the **Model Builder** window, click **Point Graph 3**.
- 2 In the **Settings** window for **Point Graph**, locate the **y-Axis Data** section.
- 3 In the **Expression** text field, type `solid.uPhaseX-2*pi`.
- 4 From the **Unit** list, choose °.

Graph Marker 1

- 1 In the **Model Builder** window, expand the **Point Graph 3** node.
- 2 Right-click **Graph Marker 1** and choose **Delete**.

Point Graph 4

- 1 In the **Model Builder** window, under **Results > Displacement Phase, X Component** click **Point Graph 4**.
- 2 In the **Settings** window for **Point Graph**, locate the **y-Axis Data** section.
- 3 In the **Expression** text field, type `solid.uPhaseX-2*pi`.
- 4 From the **Unit** list, choose °.

Add a plot showing the time history of the displacement over a period for two points and two frequencies.

Displacement History

- 1 In the **Results** toolbar, click  **ID Plot Group**.
- 2 In the **Settings** window for **ID Plot Group**, type **Displacement History** in the **Label** text field.
- 3 Locate the **Data** section. From the **Dataset** list, choose **Study 2/Solution 3 (sol3)**.

- 4 From the **Parameter selection (freq)** list, choose **From list**.
- 5 In the **Parameter values (freq (Hz))** list, select **105**.
- 6 Locate the **Title** section. From the **Title type** list, choose **None**.

Point Graph 1

- 1 Right-click **Displacement History** and choose **Point Graph**.
- 2 Select Point 1 only.
- 3 In the **Settings** window for **Point Graph**, locate the **y-Axis Data** section.
- 4 In the **Expression** text field, type **u**.
- 5 Locate the **x-Axis Data** section. From the **Parameter** list, choose **Phase**.
- 6 Locate the **Coloring and Style** section. From the **Width** list, choose **2**.
- 7 In the **Displacement History** toolbar, click  **Plot**.
- 8 Locate the **Legends** section. Select the **Show legends** checkbox.
- 9 From the **Legends** list, choose **Manual**.
- 10 In the table, enter the following settings:

Legends
Left arm, 105 Hz

Point Graph 2

- 1 Right-click **Point Graph 1** and choose **Duplicate**.
- 2 In the **Settings** window for **Point Graph**, locate the **Selection** section.
- 3 Click  **Clear Selection**.
- 4 Select Point 109 only.
- 5 Locate the **Legends** section. In the table, enter the following settings:

Legends
Right arm, 105 Hz

- 6 In the **Displacement History** toolbar, click  **Plot**.

Point Graph 1, Point Graph 2

- 1 In the **Model Builder** window, under **Results > Displacement History**, Ctrl-click to select **Point Graph 1** and **Point Graph 2**.
- 2 Right-click and choose **Duplicate**.

Point Graph 3

- 1 In the **Settings** window for **Point Graph**, locate the **Data** section.
- 2 From the **Dataset** list, choose **Study 2/Solution 3 (sol3)**.
- 3 From the **Parameter selection (freq)** list, choose **From list**.
- 4 In the **Parameter values (freq (Hz))** list, select **128**.
- 5 Locate the **Coloring and Style** section. Find the **Line style** subsection. From the **Line** list, choose **Dashed**.
- 6 From the **Color** list, choose **Cycle (reset)**.
- 7 Locate the **Legends** section. In the table, enter the following settings:

Legends
Left arm, 128 Hz

- 8 In the **Displacement History** toolbar, click  **Plot**.

Point Graph 4

- 1 In the **Model Builder** window, click **Point Graph 4**.
- 2 In the **Settings** window for **Point Graph**, locate the **Data** section.
- 3 From the **Dataset** list, choose **Study 2/Solution 3 (sol3)**.
- 4 From the **Parameter selection (freq)** list, choose **From list**.
- 5 In the **Parameter values (freq (Hz))** list, select **128**.
- 6 Locate the **Coloring and Style** section. Find the **Line style** subsection. From the **Line** list, choose **Dashed**.
- 7 Locate the **Legends** section. In the table, enter the following settings:

Legends
Right arm, 128 Hz

- 8 In the **Displacement History** toolbar, click  **Plot**.

Add a plot showing the time history of the von Mises stress at resonance over a period for a certain point.

von Mises History

- 1 In the **Results** toolbar, click  **ID Plot Group**.
- 2 In the **Settings** window for **ID Plot Group**, locate the **Data** section.
- 3 From the **Parameter selection (freq)** list, choose **From list**.
- 4 In the **Parameter values (freq (Hz))** list, select **114**.

- 5 Locate the **Title** section. From the **Title type** list, choose **None**.
- 6 In the **Label** text field, type von Mises History.

Point Graph 1

- 1 Right-click **von Mises History** and choose **Point Graph**.
- 2 Select Point 34 only.
- 3 In the **Settings** window for **Point Graph**, locate the **y-Axis Data** section.
- 4 In the **Expression** text field, type `solid.mises`.
- 5 Locate the **x-Axis Data** section. From the **Parameter** list, choose **Phase**.
- 6 In the **Phase** text field, type `(pi/20)*range(0,1,40)`.
- 7 Locate the **Legends** section. Select the **Show legends** checkbox.
- 8 From the **Legends** list, choose **Manual**.
- 9 In the table, enter the following settings:

Legends
Without prestress

- 10 In the **von Mises History** toolbar, click  **Plot**.

Point Graph 2

- 1 Right-click **Point Graph 1** and choose **Duplicate**.
- 2 In the **Settings** window for **Point Graph**, locate the **Data** section.
- 3 From the **Dataset** list, choose **Study 2/Solution 3 (sol3)**.
- 4 From the **Parameter selection (freq)** list, choose **From list**.
- 5 In the **Parameter values (freq (Hz))** list, select **107**.
- 6 Locate the **Legends** section. In the table, enter the following settings:

Legends
With prestress

- 7 Locate the **y-Axis Data** section. From the **Expression evaluated for** list, choose **Total instantaneous solution**.
- 8 In the **von Mises History** toolbar, click  **Plot**.

Point Graph 3

- 1 Right-click **Point Graph 2** and choose **Duplicate**.
- 2 In the **Settings** window for **Point Graph**, locate the **y-Axis Data** section.

- 3 From the **Expression evaluated for** list, choose **Static solution**.
- 4 Locate the **Legends** section. In the table, enter the following settings:

Legends
Static solution

- 5 In the **von Mises History** toolbar, click  **Plot**.

Point Graph 4

- 1 Right-click **Point Graph 3** and choose **Duplicate**.
- 2 In the **Settings** window for **Point Graph**, locate the **y-Axis Data** section.
- 3 From the **Expression evaluated for** list, choose **Harmonic perturbation**.
- 4 Select the **Compute differential** checkbox.
- 5 Locate the **Legends** section. In the table, enter the following settings:

Legends
Perturbation from prestress

- 6 In the **von Mises History** toolbar, click  **Plot**.

Point Graph 5

- 1 Right-click **Point Graph 4** and choose **Duplicate**.
- 2 In the **Settings** window for **Point Graph**, locate the **y-Axis Data** section.
- 3 In the **Expression** text field, type `solid.mises_peak`.
- 4 Locate the **Legends** section. In the table, enter the following settings:

Legends
Peak value for perturbation

- 5 Locate the **y-Axis Data** section. Clear the **Compute differential** checkbox.
- 6 Locate the **Coloring and Style** section. Find the **Line style** subsection. From the **Line** list, choose **Dashed**.
- 7 In the **von Mises History** toolbar, click  **Plot**.

Point Graph 3

- 1 In the **Model Builder** window, click **Point Graph 3**.
- 2 In the **Settings** window for **Point Graph**, locate the **Coloring and Style** section.
- 3 Find the **Line style** subsection. From the **Line** list, choose **Dashed**.

von Mises History

- 1** In the **Model Builder** window, click **von Mises History**.
- 2** In the **Settings** window for **ID Plot Group**, locate the **Plot Settings** section.
- 3** Select the **y-axis label** checkbox. In the associated text field, type von Mises Stress (MPa).
- 4** Locate the **Legend** section. From the **Position** list, choose **Upper left**.
- 5** In the **von Mises History** toolbar, click  **Plot**.