

# Feasibility Study of Microstrip Patch Antenna Array Design

## Introduction

---

An antenna array is a group of radiators or array of antenna elements. By controlling the phase and magnitude of the input signal assigned on each antenna element, as well as the number and arrangement of elements in the array, it is possible to steer the radiation pattern in a desired direction with a preferred level of gain. In this example, a  $4 \times 2$  array of patch antennas is fed from a single feed point, with all elements fed at equal phase and magnitude.

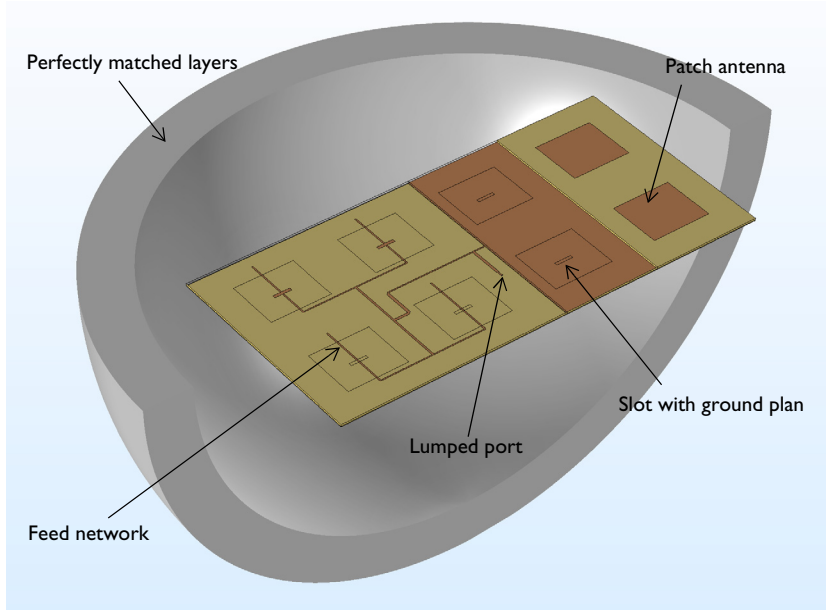

*Figure 1: A  $4 \times 2$  slot coupled microstrip patch antenna array. The model consists of a PEC ground plane, a feed network for uniform distribution excited by a lumped port beneath the ground plane, with slot coupled rectangular patch antennas above the ground plane. A perfectly matched layer domain truncates the region of free space around the antenna.*

## Model Definition

---

As the number of elements in an antenna array increases, the feed network gets more complicated. Thus, it is desirable to isolate the feed network structure from the antenna structure. In this example, the feed network and the antenna elements are placed on opposite sides of a ground plane, which allows for greater flexibility in the design.

A slot coupled microstrip patch antenna as shown in [Figure 2](#) is used as the radiating element of the array. A thin conducting patch on a substrate sits above a ground plane. A

slot in the ground plane is aligned with the center of the antenna. The feed network sits below the ground plane, a  $50\ \Omega$  microstrip line crosses over the slot, and extends some distance beyond, forming a matching stub. The antenna input impedance is optimized to minimize  $S_{11}$ , the reflected power by adjusting the size of the slot and the length of the matching stub.

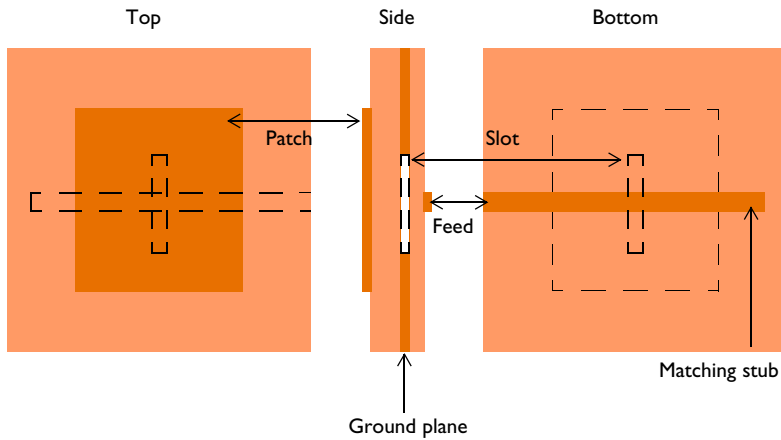

*Figure 2: Slot coupled microstrip patch antenna.*

The array antenna consists of a  $4 \times 2$  rectangular arrangement of equivalent patch antenna elements. The spacing is slightly less than one-half wavelength in free space to avoid a grating lobe and to realize more gain.

The feed network, on the opposite side of the ground plane, is designed to feed each antenna element at the same phase and magnitude. A single feed point, at the center, represents a connection to a  $50\ \Omega$  transmission line.

Quarter-wave transformers and T-junctions are used to form the  $4 \times 2$  feed network that distributes the input power uniformly into each antenna element. Two parallel  $50\ \Omega$  lines combined with a T-junction lower the input impedance and a quarter-wave transformer after the T-junction adjusts the input impedance back to  $50\ \Omega$ . This design process is repeated until the end of a line reaches the single feed point. The layout on each layer is shown in [Figure 3](#).

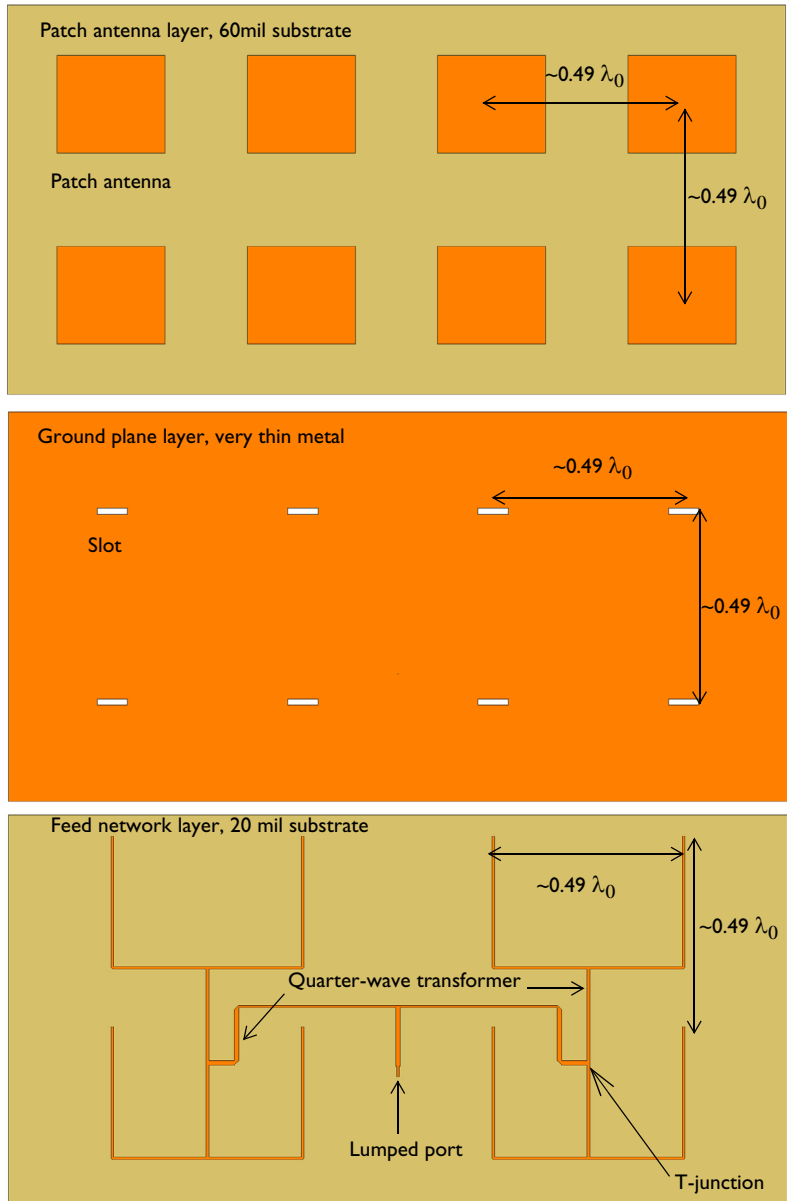

Figure 3: The view on each side of the  $4 \times 2$  slot coupled microstrip patch antenna array.

## Results and Discussion

The results show that the  $S_{11}$  is better than  $-10$  dB and the front-back ratio in the radiation pattern is more than 20 dB. In Figure 4, the E-plane is defined with the direction of the antenna polarization and includes the direction of a maximum radiation. The H-plane is the plane perpendicular to the direction of the antenna polarization. Since the number of the antenna elements in the H-plane direction is more than in the E-plane direction, the radiation pattern in the H-plane is narrower than the radiation pattern on the E-plane and  $-12$  dB sidelobes are observed only in the H-plane.

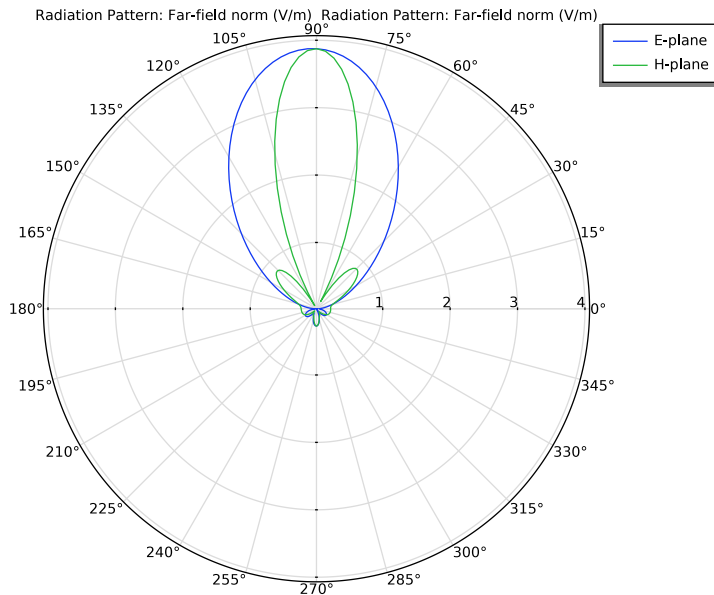
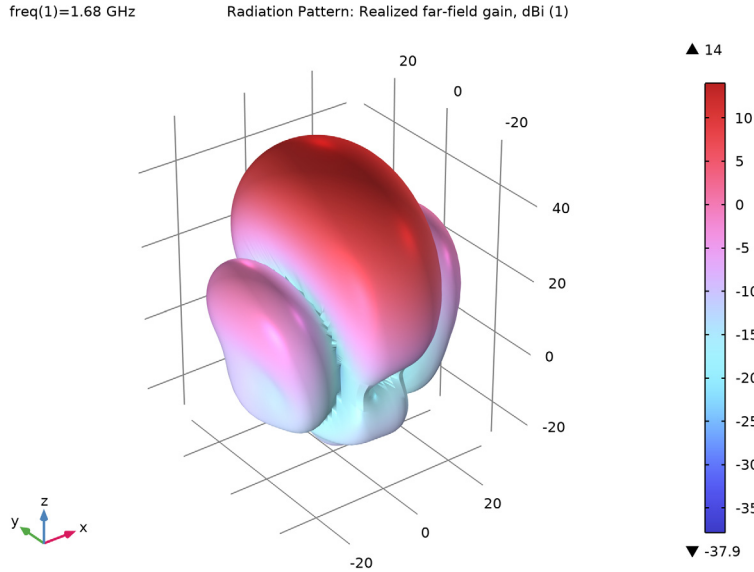

Figure 4: Far-field radiation pattern in the E-plane (blue) and the H-plane (green) at 1.68 GHz. The radiation pattern is much more directive than that of a patch antenna.



*Figure 5: 3D far-field realized gain pattern is directed toward the top side of the antenna array.*

### *Notes About the COMSOL Implementation*

---

The goal of this example is to do a feasibility study of microstrip patch antenna design. The mesh settings are adjusted to reduce the size of the problem. However, it is still a memory-intensive simulation and may require more than 6 GB RAM.

### *References*

---

1. D.M. Pozar, *Microwave Engineering*, John Wiley & Sons, 1998.
2. C.A. Balanis, *Antenna Theory*, John Wiley & Sons, 1997.
3. R.E. Collin, *Antennas and Radiowave Propagation*, McGraw Hill, 1985.

---

**Application Library path:** RF\_Module/Antenna\_Arrays/  
microstrip\_patch\_antenna\_array

---

## Modeling Instructions



---

From the **File** menu, choose **New**.

### NEW

In the **New** window, click  **Model Wizard**.

### MODEL WIZARD

- 1 In the **Model Wizard** window, click  **3D**.
- 2 In the **Select Physics** tree, select **Radio Frequency > Electromagnetic Waves, Frequency Domain (emw)**.
- 3 Click **Add**.
- 4 Click  **Study**.
- 5 In the **Select Study** tree, select **General Studies > Frequency Domain**.
- 6 Click  **Done**.

### GLOBAL DEFINITIONS

#### Parameters 1

- 1 In the **Model Builder** window, under **Global Definitions** click **Parameters 1**.
- 2 In the **Settings** window for **Parameters**, locate the **Parameters** section.
- 3 In the table, enter the following settings:



Name	Expression	Value	Description
f0	1.68[GHz]	1.68E9 Hz	Current frequency in sweep
lda0	c_const/f0	0.17845 m	Wavelength, air
h_max	0.2*lda0	0.03569 m	Maximum mesh element size, air

Here, c\_const is a predefined COMSOL constant for the speed of light in vacuum.

### GEOMETRY 1

First, import the microstrip patch antenna array design.

#### Import 1 (imp1)

- 1 In the **Geometry** toolbar, click  **Import**.
- 2 In the **Settings** window for **Import**, locate the **Source** section.
- 3 Click  **Browse**.

4 Browse to the model's Application Libraries folder and double-click the file `microstrip_patch_antenna_array.mphbin`.

5 Click  **Import**.

Choose wireframe rendering to get a better view of the interior parts.

6 Click the  **Wireframe Rendering** button in the **Graphics** toolbar.

Add a sphere for the perfectly matched layers. Use a layer definition to create shell-type sphere structure.

*PML*

1 In the **Geometry** toolbar, click  **Sphere**.

2 In the **Settings** window for **Sphere**, type PML in the **Label** text field.

3 Locate the **Size** section. In the **Radius** text field, type 0.275.

4 Click to expand the **Layers** section. In the table, enter the following settings:

Layer name	Thickness (m)
Layer 1	0.04

5 Click  **Build All Objects**.

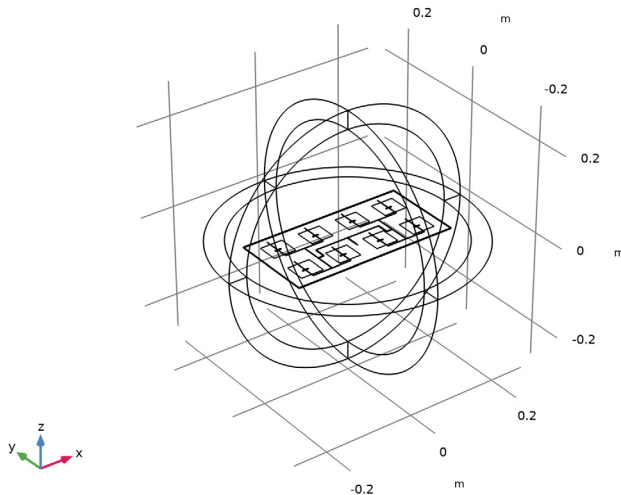

Disable the analysis of the geometry as the remaining small geometric details are needed.

6 In the **Model Builder** window, click **Geometry 1**.

**7** In the **Settings** window for **Geometry**, locate the **Cleanup** section.

**8** Clear the **Automatic detection of small details** checkbox.

## DEFINITIONS

Create a set of selections for use when setting up the physics. First, create a selection for the patch antennas.

### *Patch*

- 1** In the **Definitions** toolbar, click  **Explicit**.
- 2** In the **Settings** window for **Explicit**, type Patch in the **Label** text field.
- 3** Locate the **Input Entities** section. From the **Geometric entity level** list, choose **Boundary**.
- 4** Select Boundaries 22, 23, 27, 28, 48, 49, 52, and 53 only.

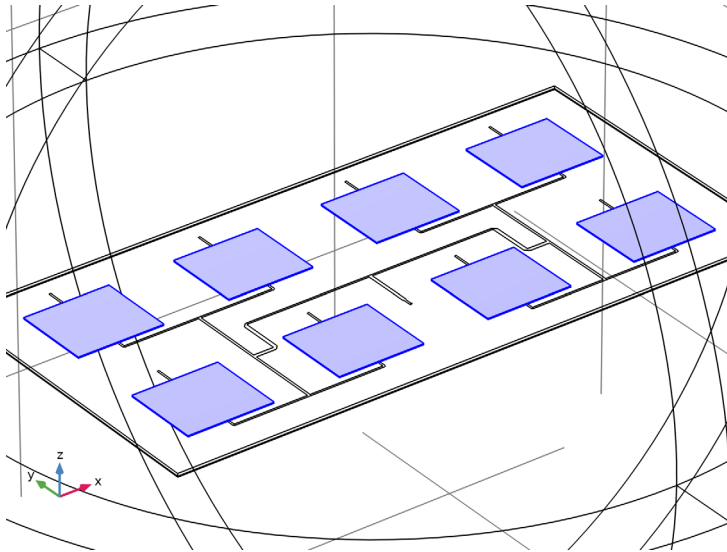

Add selections for the feed network, slot, ground, and substrate.

### *Feed network*

- 1** In the **Definitions** toolbar, click  **Explicit**.
- 2** In the **Settings** window for **Explicit**, type Feed network in the **Label** text field.
- 3** Locate the **Input Entities** section. From the **Geometric entity level** list, choose **Boundary**.

4 Select Boundary 26 only.

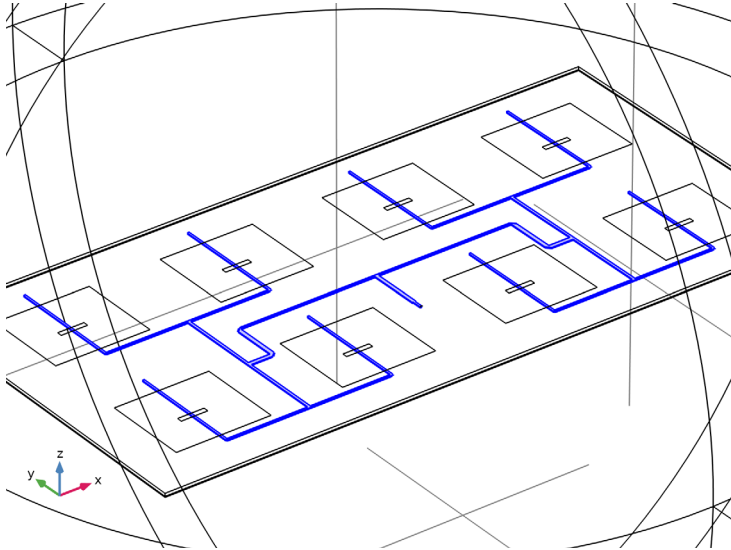

*Slot*

- 1 In the **Definitions** toolbar, click  **Explicit**.
- 2 In the **Settings** window for **Explicit**, type Slot in the **Label** text field.
- 3 Locate the **Input Entities** section. From the **Geometric entity level** list, choose **Boundary**.

4 Select Boundaries 24, 25, 29, 30, 50, 51, 54, and 55 only.

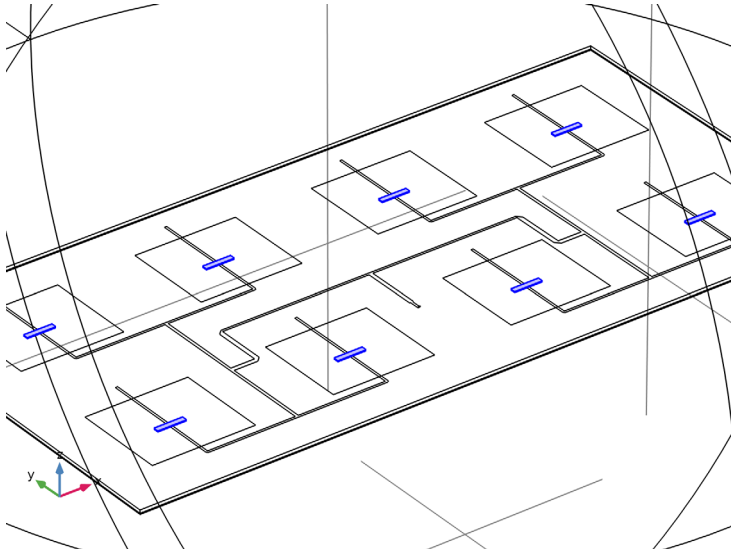

*Ground*

- 1 In the **Definitions** toolbar, click  **Explicit**.
- 2 In the **Settings** window for **Explicit**, type **Ground** in the **Label** text field.
- 3 Locate the **Input Entities** section. From the **Geometric entity level** list, choose **Boundary**.

4 Select Boundary 18 only.

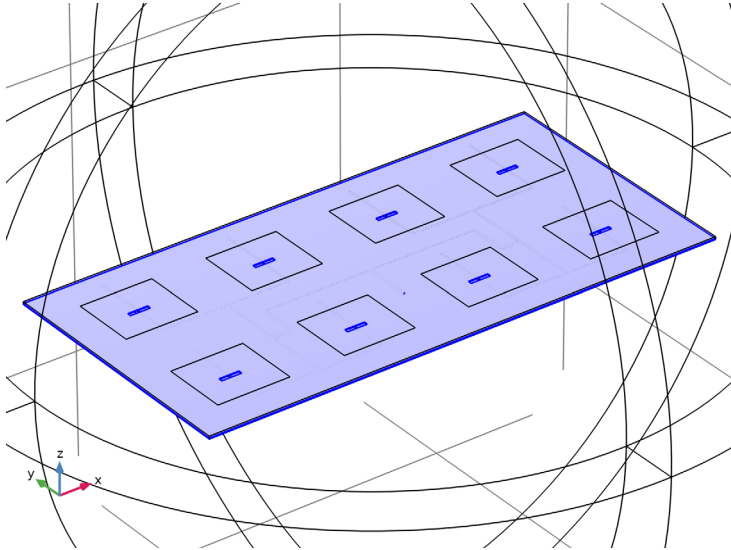

*Substrate*

- 1 In the **Definitions** toolbar, click  **Explicit**.
- 2 In the **Settings** window for **Explicit**, type **Substrate** in the **Label** text field.

3 Select Domains 6 and 7 only.

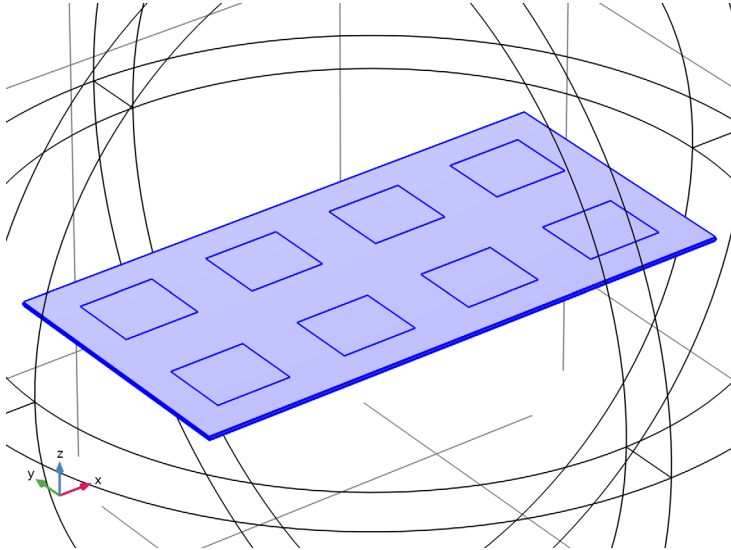

Zoom out to get a view of the entire structure.

4 Click the  **Zoom Out** button in the **Graphics** toolbar.

*Perfectly Matched Layer 1 (pml1)*

1 In the **Definitions** toolbar, click  **Perfectly Matched Layer**.

2 Select Domains 1–4 and 8–11 only.

3 In the **Settings** window for **Perfectly Matched Layer**, locate the **Geometry** section.

4 From the **Type** list, choose **Spherical**.

To get a better view, suppress some of the domains. Furthermore, by assigning the resulting settings to a View node, you can easily return to the same view later by clicking the **Go to View 2** button in the **Graphics** toolbar.

*View 2*

1 In the **Model Builder** window, under **Component 1 (comp1)** right-click **Definitions** and choose **View**.

2 Click the  **Wireframe Rendering** button in the **Graphics** toolbar.

*Hide for Physics 1*

1 In the **Model Builder** window, right-click **View 2** and choose **Hide for Physics**.

2 Select Domains 2, 4, 9, and 11 only.

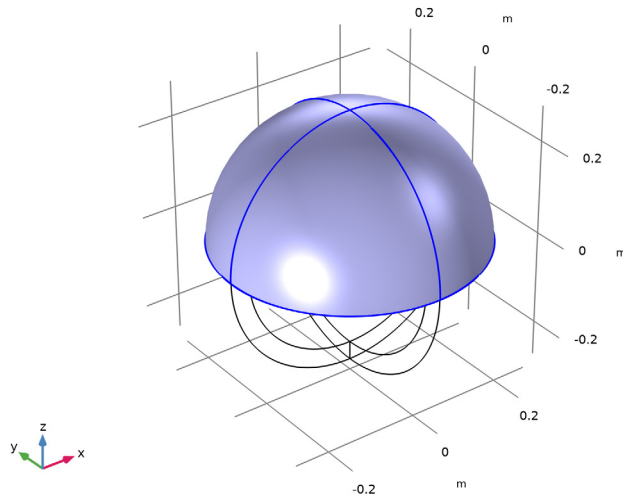

*Hide for Physics 2*

- 1 In the **Model Builder** window, right-click **View 2** and choose **Hide for Physics**.
- 2 In the **Settings** window for **Hide for Physics**, locate the **Geometric Entity Selection** section.
- 3 From the **Geometric entity level** list, choose **Boundary**.

4 Select Boundaries 10, 12, 38, and 45 only.

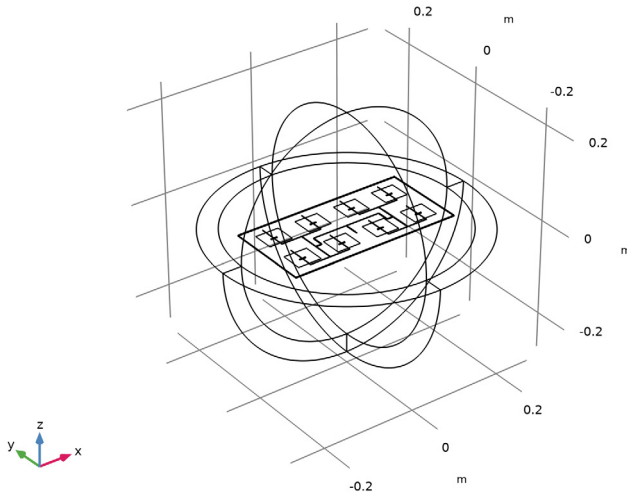

## ELECTROMAGNETIC WAVES, FREQUENCY DOMAIN (EMW)

### *Perfect Electric Conductor 2*

- 1 In the **Physics** toolbar, click  **Boundaries** and choose **Perfect Electric Conductor**.
- 2 In the **Settings** window for **Perfect Electric Conductor**, locate the **Boundary Selection** section.
- 3 From the **Selection** list, choose **Patch**.



### *Perfect Electric Conductor 3*

- 1 In the **Physics** toolbar, click  **Boundaries** and choose **Perfect Electric Conductor**.
- 2 In the **Settings** window for **Perfect Electric Conductor**, locate the **Boundary Selection** section.
- 3 From the **Selection** list, choose **Feed network**.

### *Perfect Electric Conductor 4*

- 1 In the **Physics** toolbar, click  **Boundaries** and choose **Perfect Electric Conductor**.
- 2 In the **Settings** window for **Perfect Electric Conductor**, locate the **Boundary Selection** section.
- 3 From the **Selection** list, choose **Ground**.

### Lumped Port 1

- 1 In the **Physics** toolbar, click  **Boundaries** and choose **Lumped Port**.
- 2 Click the  **Zoom In** button in the **Graphics** toolbar, a couple of times to see the port boundary clearly.
- 3 Select Boundary 31 only.

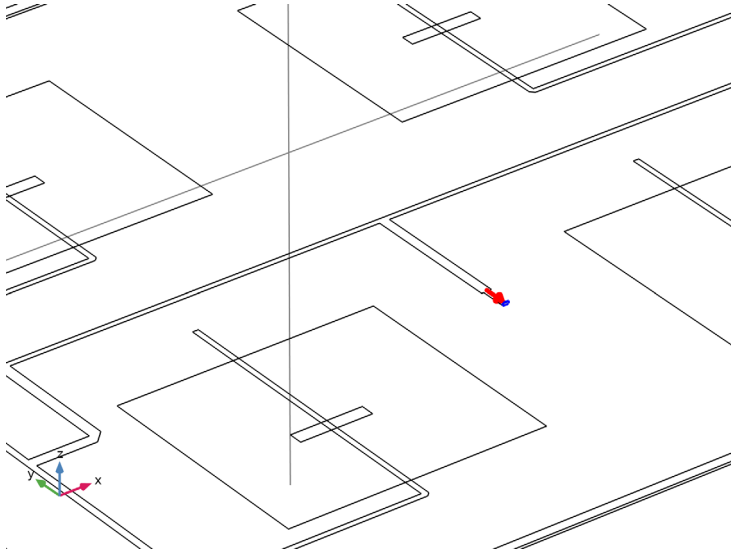

For the first port, wave excitation is **on** by default.

- 4 Click the  **Zoom Extents** button in the **Graphics** toolbar.



### Far-Field Domain 1

In the **Physics** toolbar, click  **Domains** and choose **Far-Field Domain**.

## MATERIALS

Next, assign material properties to the model. Begin by specifying air for all domains.

### ADD MATERIAL

- 1 In the **Materials** toolbar, click  **Add Material** to open the **Add Material** window.
- 2 Go to the **Add Material** window.
- 3 In the tree, select **Built-in > Air**.
- 4 Click the **Add to Component** button in the window toolbar.
- 5 In the **Materials** toolbar, click  **Add Material** to close the **Add Material** window.

## MATERIALS

Override the substrate with the dielectric material of  $\epsilon_r = 3.38$ .

### Substrate

- 1 In the **Model Builder** window, under **Component 1 (comp1)** right-click **Materials** and choose **Blank Material**.
- 2 In the **Settings** window for **Material**, type Substrate in the **Label** text field.
- 3 Locate the **Geometric Entity Selection** section. From the **Selection** list, choose **Substrate**.
- 4 Locate the **Material Contents** section. In the table, enter the following settings:

Property	Variable	Value	Unit	Property group
Relative permittivity	epsilon_nr_iso ; epsilon_nr_ii = epsilon_nr_iso, epsilon_nr_ij = 0	3.38		Basic
Relative permeability	mu_r_iso ; mu_r_ii = mu_r_iso, mu_r_ij = 0	1		Basic
Electric conductivity	sigma_iso ; sigma_ii = sigma_iso, sigma_ij = 0	0	S/m	Basic

## MESH 1

Choose the maximum mesh size in the air domain smaller than 0.2 wavelengths using the parameter  $h_{max}$  that you defined earlier. Scale the mesh size inside the substrate by the inverse of the square root of the relative dielectric constant of the substrate.

### Size 1

- 1 In the **Model Builder** window, under **Component 1 (comp1)** right-click **Mesh 1** and choose **Size**.
- 2 In the **Settings** window for **Size**, locate the **Element Size** section.
- 3 Click the **Custom** button.
- 4 Locate the **Element Size Parameters** section.
- 5 Select the **Maximum element size** checkbox. In the associated text field, type  $h_{max}$ .
- 6 Select the **Maximum element growth rate** checkbox. In the associated text field, type 2.5.

Due to the thin substrate, use a smaller value for the maximum mesh size than that initially suggested.

#### *Size 2*

- 1 In the **Model Builder** window, right-click **Mesh 1** and choose **Size**.
- 2 In the **Settings** window for **Size**, locate the **Geometric Entity Selection** section.
- 3 From the **Geometric entity level** list, choose **Domain**.
- 4 From the **Selection** list, choose **Substrate**.
- 5 Locate the **Element Size** section. Click the **Custom** button.
- 6 Locate the **Element Size Parameters** section.
- 7 Select the **Maximum element size** checkbox. In the associated text field, type  $h_{\max} / \sqrt{3.38} / 2$ .

To resolve the small parts properly, refine the mesh further in each selection of the model.

#### *Size 3*

- 1 Right-click **Mesh 1** and choose **Size**.
- 2 In the **Settings** window for **Size**, locate the **Geometric Entity Selection** section.
- 3 From the **Geometric entity level** list, choose **Boundary**.
- 4 From the **Selection** list, choose **Feed network**.
- 5 Locate the **Element Size** section. Click the **Custom** button.
- 6 Locate the **Element Size Parameters** section.
- 7 Select the **Maximum element size** checkbox. In the associated text field, type 1.8[mm].
- 8 Select the **Minimum element size** checkbox. In the associated text field, type 0.5[mm].

#### *Size 4*

- 1 Right-click **Mesh 1** and choose **Size**.
- 2 In the **Settings** window for **Size**, locate the **Geometric Entity Selection** section.
- 3 From the **Geometric entity level** list, choose **Boundary**.
- 4 From the **Selection** list, choose **Slot**.
- 5 Locate the **Element Size** section. Click the **Custom** button.
- 6 Locate the **Element Size Parameters** section.
- 7 Select the **Maximum element size** checkbox. In the associated text field, type 2[mm].

#### *Size 5*

- 1 Right-click **Mesh 1** and choose **Size**.

- 2 In the **Settings** window for **Size**, locate the **Geometric Entity Selection** section.
- 3 From the **Geometric entity level** list, choose **Boundary**.
- 4 From the **Selection** list, choose **Patch**.
- 5 Locate the **Element Size** section. Click the **Custom** button.
- 6 Locate the **Element Size Parameters** section.
- 7 Select the **Maximum element size** checkbox. In the associated text field, type 2[mm].

#### *Size 6*

- 1 Right-click **Mesh 1** and choose **Size**.
- 2 In the **Settings** window for **Size**, locate the **Geometric Entity Selection** section.
- 3 From the **Geometric entity level** list, choose **Boundary**.
- 4 From the **Selection** list, choose **Ground**.
- 5 Locate the **Element Size** section. Click the **Custom** button.
- 6 Locate the **Element Size Parameters** section.
- 7 Select the **Maximum element size** checkbox. In the associated text field, type 4[mm].

#### *Free Tetrahedral 1*

- 1 In the **Mesh** toolbar, click  **Free Tetrahedral**.
- 2 In the **Settings** window for **Free Tetrahedral**, locate the **Domain Selection** section.
- 3 From the **Geometric entity level** list, choose **Domain**.
- 4 Select Domains 5–7 only.

Use a swept mesh for the PMLs.

#### *Swept 1*

In the **Mesh** toolbar, click  **Swept**.

#### *Distribution 1*

- 1 Right-click **Swept 1** and choose **Distribution**.

2 Right-click **Mesh 1** and choose **Build All**.

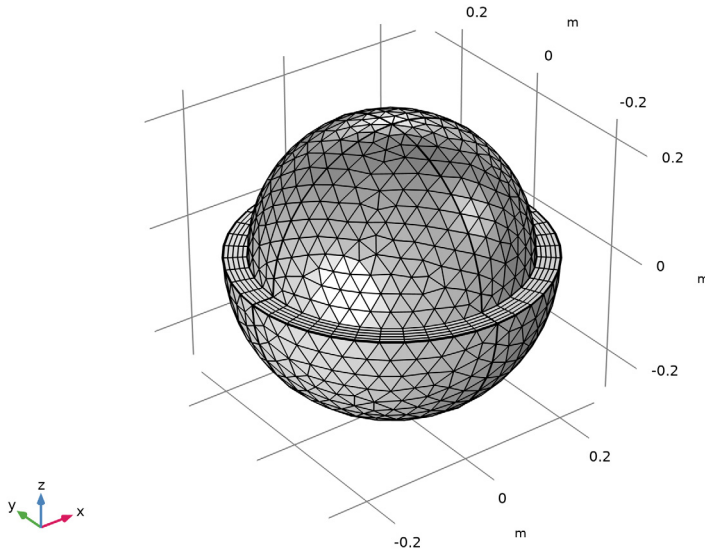

## STUDY 1

### Step 1: Frequency Domain

- 1 In the **Model Builder** window, under **Study 1** click **Step 1: Frequency Domain**.
- 2 In the **Settings** window for **Frequency Domain**, locate the **Study Settings** section.
- 3 In the **Frequencies** text field, type  $f_0$ .
- 4 In the **Study** toolbar, click **Compute**.

## RESULTS

### Electric Field (emw)

Begin the results analysis by reviewing the plot showing the distribution of the electric field norm.

### Multislice

- 1 In the **Model Builder** window, expand the **Electric Field (emw)** node, then click **Multislice**.
- 2 In the **Settings** window for **Multislice**, locate the **Expression** section.
- 3 In the **Expression** text field, type  $20 * \log_{10}(emw.normE)$ .

- 4 Locate the **Multipane Data** section. Find the **X-planes** subsection. In the **Planes** text field, type 0.
- 5 Find the **Y-planes** subsection. In the **Planes** text field, type 0.
- 6 Find the **Z-planes** subsection. From the **Entry method** list, choose **Coordinates**.
- 7 In the **Coordinates** text field, type 1.524[mm].
- 8 Locate the **Coloring and Style** section. From the **Color table** list, choose **HeatCameraLight**.

#### *Selection 1*

- 1 Right-click **Multislice** and choose **Selection**.
- 2 Select Domain 7 only.
- 3 Click the  **Zoom to Selection** button in the **Graphics** toolbar.

#### *Deformation 1*

- 1 Right-click **Multislice** and choose **Deformation**.
- 2 In the **Settings** window for **Deformation**, locate the **Expression** section.
- 3 In the **X-component** text field, type 0.
- 4 In the **Y-component** text field, type 0.
- 5 In the **Z-component** text field, type  $20 \cdot \log_{10}(\text{emw}.\text{normE})$ .

6 In the **Electric Field (emw)** toolbar, click  **Plot**.

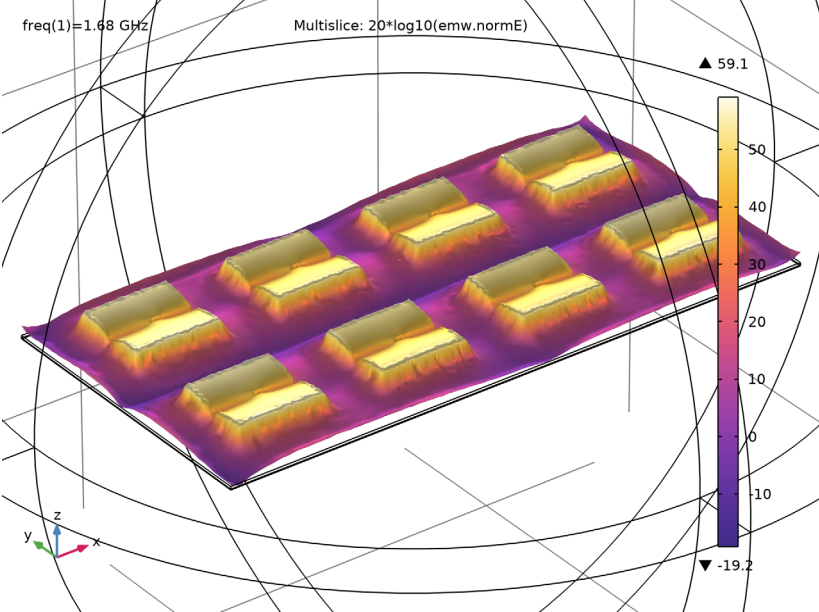

Strong electric fields are observed on the radiating edges.

### Electric Field, Logarithmic (emw)

In the **Model Builder** window, under **Results** click **Electric Field, Logarithmic (emw)**.

freq(1)=1.68 GHz Surface: 1 (1) Multislice: Electric field norm (V/m) Surface: Electric field norm (V/m)

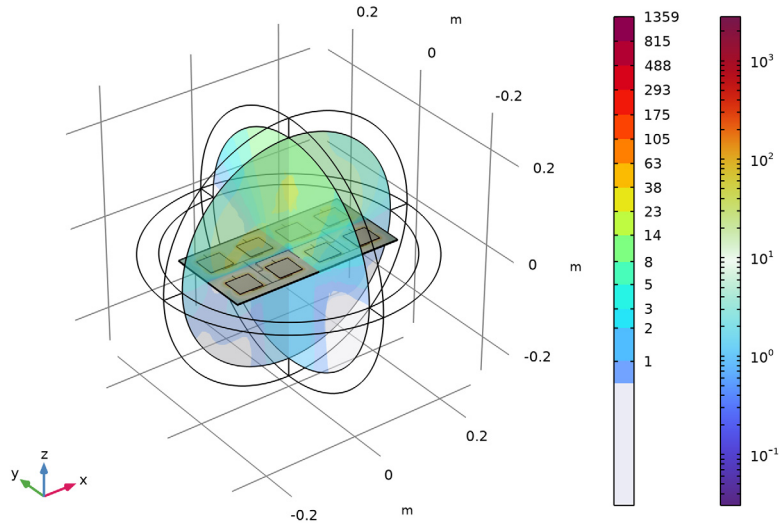

Adjust the polar plot settings to visualize the far-field pattern on the E-plane.

### Radiation Pattern 1

- 1 In the **Model Builder** window, expand the **Results > 2D Far Field (emw)** node, then click **Radiation Pattern 1**.
- 2 In the **Settings** window for **Radiation Pattern**, locate the **Evaluation** section.
- 3 Find the **Normal vector** subsection. In the **x** text field, type 1.
- 4 In the **z** text field, type 0.
- 5 Find the **Reference direction** subsection. In the **x** text field, type 0.
- 6 In the **y** text field, type 1.
- 7 Click to expand the **Legends** section. From the **Legends** list, choose **Manual**.
- 8 In the table, enter the following settings:

#### Legends

E-plane

9 In the **2D Far Field (emw)** toolbar, click  **Plot**.

The E-plane in this model is located on the  $yz$ -plane where  $\phi$  is measured counterclockwise from the  $y$ -axis.

Add the H-plane polar plot.

#### *Radiation Pattern 2*

- 1 Right-click **Results > 2D Far Field (emw) > Radiation Pattern I** and choose **Duplicate**.
- 2 In the **Settings** window for **Radiation Pattern**, locate the **Evaluation** section.
- 3 Find the **Reference direction** subsection. In the **x** text field, type 1.
- 4 In the **y** text field, type 0.
- 5 Find the **Normal vector** subsection. In the **x** text field, type 0.
- 6 In the **y** text field, type -1.
- 7 Locate the **Legends** section. In the table, enter the following settings:

---

#### **Legends**

---

##### H-plane

---

8 In the **2D Far Field (emw)** toolbar, click  **Plot**.

The H-plane is located on the  $xz$ -plane where  $\phi$  is measured counterclockwise from the  $x$ -axis.

Compare the resulting plot with that shown in [Figure 4](#).

#### *Radiation Pattern 1*

- 1 In the **Model Builder** window, expand the **3D Far Field, Gain (emw)** node, then click **Radiation Pattern I**.
- 2 In the **Settings** window for **Radiation Pattern**, locate the **Evaluation** section.
- 3 Find the **Angles** subsection. In the **Number of elevation angles** text field, type 90.
- 4 In the **Number of azimuth angles** text field, type 90.
- 5 Locate the **Coloring and Style** section. From the **Color table** list, choose **DiscoLight**.
- 6 In the **3D Far Field, Gain (emw)** toolbar, click  **Plot**.

#### **DIRECTIVITY**

1 Go to the **Directivity** window.

Compare the 3D far-field realized gain pattern plot with [Figure 5](#).

## **RESULTS**

Finish by inspecting the input matching characteristic of the antenna array.

