



Uniform Layer Waveguide

Introduction

Whenever dimensions in waveguides become small compared to the viscous and thermal boundary layers, it is necessary to model acoustics using thermoviscous acoustics. In the present model, the thermoviscous acoustic wave field in a shallow uniform waveguide is modeled and compared with an analytical solution.

Model Definition

An infinitely wide slit of length L and height H is subject to a harmonically varying pressure drop of 1 Pa. In order to reduce the model size, only a section of width L is modeled using symmetry conditions. The waveguide top and bottom are modeled as no slip isothermal walls.

Model parameters are summarized in [Table 1](#).

TABLE 1: LOADED PARAMETERS.

PARAMETER	EXPRESSION	DESCRIPTION
f_0	500 Hz	Frequency
T_0	293 K	Ambient temperature
p_0	1 atm	Atmospheric pressure
H	1 mm	Waveguide height
L	5 mm	Waveguide side lengths
p_{in}	1 Pa	Inlet pressure
d_{visc}	$0.22\text{mm} \sqrt{\frac{100\text{Hz}}{f_0}}$	Approximate expression for the viscous boundary layer scale at 20°C and 1 atm.

ANALYTICAL THEORY

A thermoviscous acoustics problem can in principle be thought of as a three-wave problem, each with its own wave number: the acoustic k_0 , the viscous k_v , and the thermal k_{th} , with

$$k_0 = \frac{\omega}{c_0} \quad k_v^2 = \frac{-i\omega\rho_0}{\mu} \quad k_{\text{th}}^2 = \frac{-i\omega\rho_0 C_p}{k}$$

where c_0 is the isentropic speed of sound, ω is the angular frequency, ρ_0 is the static density, μ is the dynamic viscosity, C_p is the heat capacity, and k is the thermal conductance.

The thermal and viscous waves are rapidly decaying waves normal to a wall. The three waves interact and in the case of geometries with small dimensions, this interaction becomes evident. In simple geometries, analytical solutions of this interaction exist. In the case of a uniform slit, the cross-sectional variation of the temperature T and velocity \mathbf{u} is:

$$\mathbf{u} = \frac{-\Psi_v \nabla p}{i k_0 Z_0} \quad T = \frac{\Psi_{th} p}{\rho_0 C_p}$$

where the function Ψ is a complex-valued scalar field

$$\Psi_\phi = 1 - \frac{\cos(k_\phi z)}{\cos\left(k_\phi \frac{H}{2}\right)}$$

and ϕ is either v or th. The pressure gradient and the pressure are in this simple geometry given by (disregarding the phase)

$$\nabla p = \frac{p_{in} - p_{out}}{L} \quad p = \nabla p \cdot (L - x)$$

Results and Discussion

At 500 Hz, the characteristic size of the viscous boundary layer is about 0.1 mm (for air at 20°C), this length is 1/10 of the waveguide thickness H . This is seen in [Figure 1](#) as the changing colors region near the wall where the velocity is varying to fulfill the no slip condition.

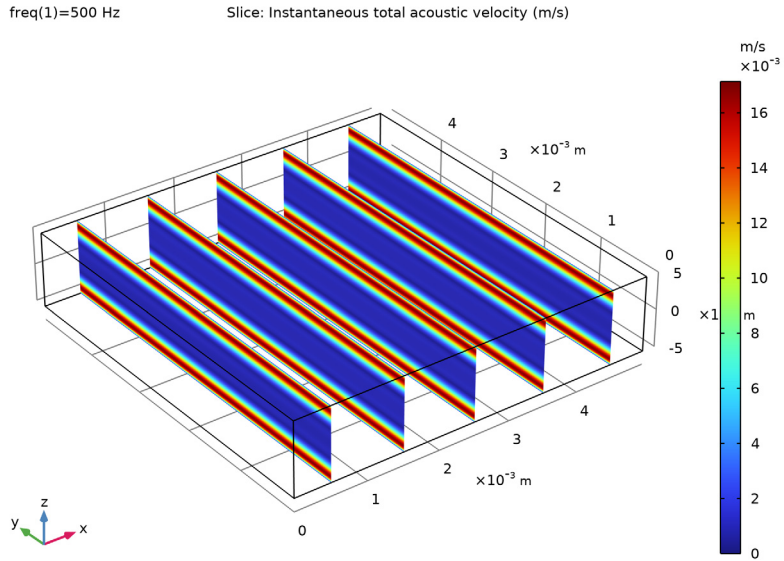

Figure 1: Slice plot of the instantaneous particle velocity U . Outside the boundary layer (red regions) the velocity profile becomes flat as in pressure acoustics.

The velocity and temperature profiles are probed using a 3D cut line and compared to the expressions found in the theory. The velocity profile is shown in [Figure 2](#), while the temperature profile is shown in [Figure 3](#). The results agree very well. When modeling acoustics in small dimensions, it is essential to include the thermal and viscous losses (see [Ref. 1](#)).

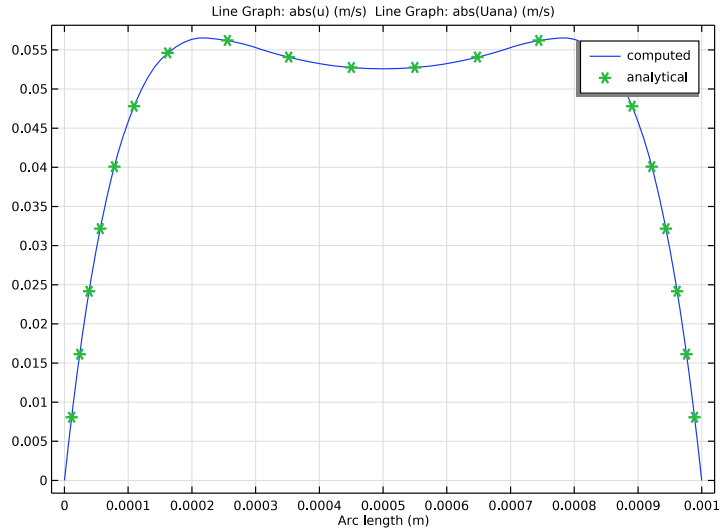

Figure 2: Comparison of the analytical and numerical velocity profiles.

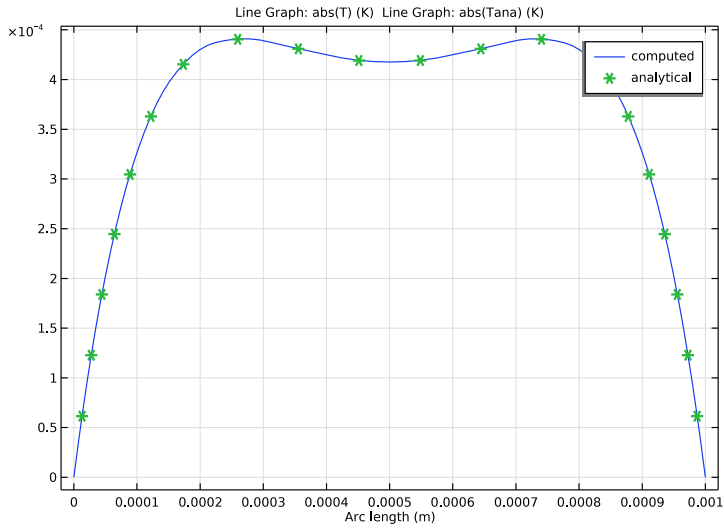

Figure 3: Comparison of the analytical and the COMSOL Multiphysics-generated solution for the amplitude of the acoustic temperature variation T .

Reference

1. H. Tijdeman, “On the propagation of sound waves in cylindrical tubes,” *J. Sound Vib.*, vol. 39, no. 1, pp. 1–33, 1975.

Application Library path: Acoustics_Module/Verification_Examples/
uniform_layer_waveguide



Modeling Instructions

From the **File** menu, choose **New**.

NEW

In the **New** window, click  **Model Wizard**.

MODEL WIZARD

- 1 In the **Model Wizard** window, click  **3D**.
- 2 In the **Select Physics** tree, select **Acoustics** > **Thermoviscous Acoustics** > **Thermoviscous Acoustics, Frequency Domain (ta)**.
- 3 Click **Add**.
- 4 Click  **Study**.
- 5 In the **Select Study** tree, select **General Studies** > **Frequency Domain**.
- 6 Click  **Done**.

GLOBAL DEFINITIONS

Parameters 1

- 1 In the **Model Builder** window, under **Global Definitions** click **Parameters 1**.
- 2 In the **Settings** window for **Parameters**, locate the **Parameters** section.
- 3 Click  **Load from File**.
- 4 Browse to the model's Application Libraries folder and double-click the file `uniform_layer_waveguide_parameters.txt`.



DEFINITIONS

Variables 1

- 1 In the **Model Builder** window, under **Component 1 (comp1)** right-click **Definitions** and choose **Variables**.
- 2 In the **Settings** window for **Variables**, locate the **Variables** section.
- 3 Click  **Load from File**.
- 4 Browse to the model's Application Libraries folder and double-click the file `uniform_layer_waveguide_variables.txt`.



GEOMETRY 1

Block 1 (blk1)

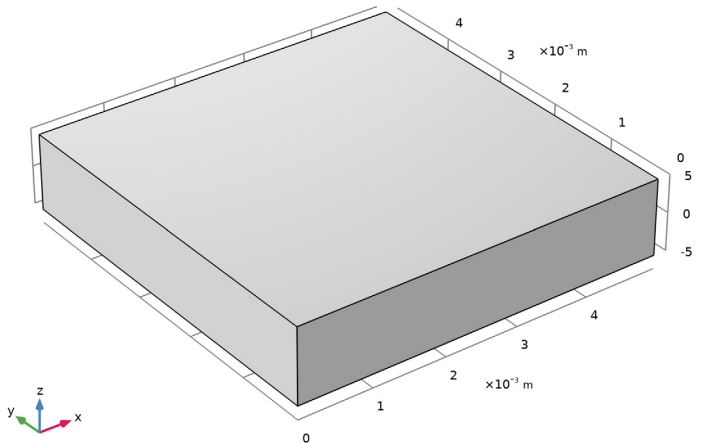
- 1 In the **Geometry** toolbar, click  **Block**.
- 2 In the **Settings** window for **Block**, locate the **Size and Shape** section.
- 3 In the **Width** text field, type L.
- 4 In the **Depth** text field, type L.
- 5 In the **Height** text field, type H.
- 6 Locate the **Position** section. In the **z** text field, type $-H/2$.
- 7 Click  **Build Selected**.
- 8 Click the  **Zoom Extents** button in the **Graphics** toolbar.



ADD MATERIAL

- 1 In the **Materials** toolbar, click  **Add Material** to open the **Add Material** window.
- 2 Go to the **Add Material** window.
- 3 In the tree, select **Built-in > Air**.
- 4 Click the **Add to Component** button in the window toolbar.
- 5 In the **Materials** toolbar, click  **Add Material** to close the **Add Material** window.

THERMOVISCOUS ACOUSTICS, FREQUENCY DOMAIN (TA)

Thermoviscous Acoustics Model 1

- 1 In the **Settings** window for **Thermoviscous Acoustics Model**, locate the **Model Input** section.
- 2 In the T_0 text field, type T0.
- 3 In the p_0 text field, type p0.

Symmetry 1

- 1 In the **Physics** toolbar, click  **Boundaries** and choose **Symmetry**.
- 2 Select Boundaries 2 and 5 only.

Pressure (Adiabatic) 1

- 1 In the **Physics** toolbar, click  **Boundaries** and choose **Pressure (Adiabatic)**.
- 2 Select Boundary 1 only.
- 3 In the **Settings** window for **Pressure (Adiabatic)**, locate the **Pressure** section.
- 4 In the p_{bnd} text field, type pin.

Pressure (Adiabatic) 2

- 1 In the **Physics** toolbar, click  **Boundaries** and choose **Pressure (Adiabatic)**.
- 2 Select Boundary 6 only.

MESH 1

When modeling thermoviscous acoustics, it is important that the mesh resolves the acoustic boundary layers properly. In the parameters list the quantity d_{visc} gives the viscous boundary layer penetration depth (the characteristic scale of the layer), in air, for the frequency f_0 . This parameter is used in the boundary layer mesh properties in order to get a proper mesh. The viscous and thermal waves are highly damped over the wavelength $2\pi d_{\text{visc}}$, so a good total scale for the layer can be πd_{visc} .

Mapped 1

- 1 In the **Mesh** toolbar, click  **More Generators** and choose **Mapped**.
- 2 Select Boundary 1 only.

Distribution 1

- 1 Right-click **Mapped 1** and choose **Distribution**.
- 2 Select Edges 4 and 6 only.
- 3 In the **Settings** window for **Distribution**, locate the **Distribution** section.
- 4 In the **Number of elements** text field, type 3.
- 5 Click  **Build Selected**.

Swept 1

In the **Mesh** toolbar, click  **Swept**.

Distribution 1

- 1 Right-click **Swept 1** and choose **Distribution**.
- 2 Right-click **Distribution 1** and choose **Build Selected**.

Boundary Layers 1

In the **Mesh** toolbar, click  **Boundary Layers**.

Boundary Layer Properties

- 1 In the **Model Builder** window, click **Boundary Layer Properties**.
- 2 Select Boundaries 3 and 4 only.
- 3 In the **Settings** window for **Boundary Layer Properties**, locate the **Layers** section.
- 4 In the **Number of layers** text field, type 5.
- 5 From the **Thickness specification** list, choose **All layers**.
- 6 In the **Total thickness** text field, type $\pi * d_{\text{visc}}$.

7 Click  **Build All**.

The finished mesh should look like that in the figure below.

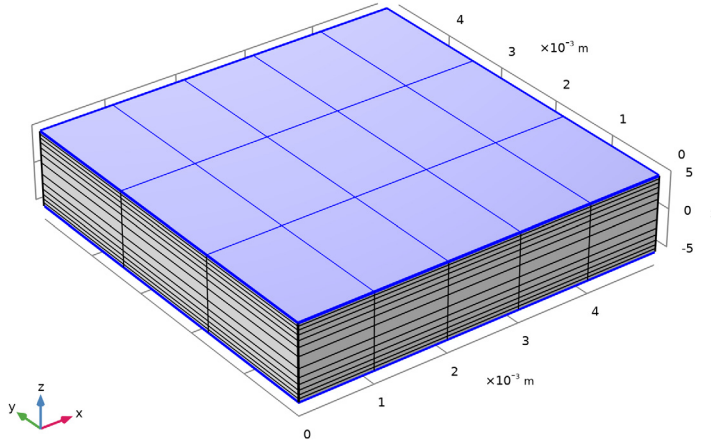

Mesh of the uniform layer waveguide including the boundary layer mesh.

STUDY I

Step 1: Frequency Domain

- 1 In the **Model Builder** window, under **Study I** click **Step 1: Frequency Domain**.
- 2 In the **Settings** window for **Frequency Domain**, locate the **Study Settings** section.
- 3 In the **Frequencies** text field, type f_0 .
- 4 In the **Study** toolbar, click  **Compute**.

RESULTS

Acoustic Velocity (ta)

The second default plot shows a slice plot of the instantaneous particle velocity [Figure 1](#).

To compare the analytical and numerical velocity and temperature profiles, as done in [Figure 2](#) and [Figure 3](#), follow the steps given below.

Cut Line 3D 1

- 1 In the **Results** toolbar, click  **Cut Line 3D**.
- 2 In the **Settings** window for **Cut Line 3D**, locate the **Line Data** section.

- 3 In row **Point 1**, set **X** to $L/2$, **y** to $L/2$, and **z** to $H/2$.
- 4 In row **Point 2**, set **X** to $L/2$, **y** to $L/2$, and **z** to $-H/2$.
- 5 Click  **Plot**.

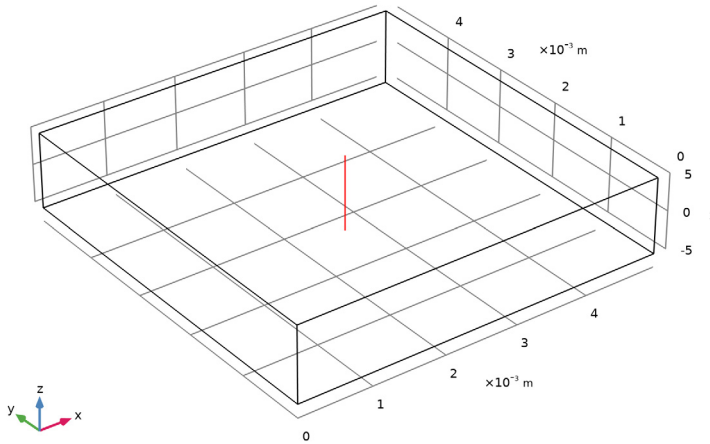

Velocity Profile

- 1 In the **Results** toolbar, click  **ID Plot Group**.
- 2 In the **Settings** window for **ID Plot Group**, type Velocity Profile in the **Label** text field.
- 3 Locate the **Data** section. From the **Dataset** list, choose **Cut Line 3D 1**.

Line Graph 1

- 1 Right-click **Velocity Profile** and choose **Line Graph**.
- 2 In the **Settings** window for **Line Graph**, locate the **y-Axis Data** section.
- 3 In the **Expression** text field, type $\text{abs}(u)$.
- 4 Click to expand the **Legends** section. Select the **Show legends** checkbox.
- 5 From the **Legends** list, choose **Manual**.
- 6 In the table, enter the following settings:

Legends
computed

Line Graph 2

- 1 In the **Model Builder** window, right-click **Velocity Profile** and choose **Line Graph**.
- 2 In the **Settings** window for **Line Graph**, locate the **y-Axis Data** section.
- 3 In the **Expression** text field, type `abs(Uana)`.
- 4 Click to expand the **Coloring and Style** section. Find the **Line style** subsection. From the **Line** list, choose **None**.
- 5 Find the **Line markers** subsection. From the **Marker** list, choose **Cycle**.
- 6 From the **Positioning** list, choose **Interpolated**.
- 7 In the **Number** text field, type 20.
- 8 Locate the **Legends** section. Select the **Show legends** checkbox.
- 9 From the **Legends** list, choose **Manual**.
- 10 In the table, enter the following settings:

Legends
analytical

- 11 In the **Velocity Profile** toolbar, click  **Plot**.

Temperature Profile

- 1 Right-click **Velocity Profile** and choose **Duplicate**.
- 2 In the **Settings** window for **ID Plot Group**, type `Temperature Profile` in the **Label** text field.

Line Graph 1

- 1 In the **Model Builder** window, expand the **Temperature Profile** node, then click **Line Graph 1**.
- 2 In the **Settings** window for **Line Graph**, locate the **y-Axis Data** section.
- 3 In the **Expression** text field, type `abs(T)`.

Line Graph 2

- 1 In the **Model Builder** window, click **Line Graph 2**.
- 2 In the **Settings** window for **Line Graph**, locate the **y-Axis Data** section.
- 3 In the **Expression** text field, type `abs(Tana)`.
- 4 In the **Temperature Profile** toolbar, click  **Plot**.