

Loudspeaker Driver — Frequency-Domain Analysis

Introduction

This example shows how to model a loudspeaker driver of the dynamic cone type, common for low and medium frequencies. The analysis is carried out in the frequency domain and thus represents the linear behavior of the driver. The instructions walk you through modeling its electromagnetic, structural, and acoustic properties. The output from the model includes the total electric impedance and the sensitivity (the on-axis sound pressure level at a nominal driving voltage) as functions of the frequency. The spatial characteristics of the speaker are depicted in a directivity plot.

When performing the acoustic measurements in this model, the driver is set up in an infinite baffle — a wide reflective surface acting to shut out the sound produced on the backside of the cone. Two extended 3D version of the model exist: the [Loudspeaker Driver in a Vented Enclosure](#), uses the lumped electromechanical properties modeled here and adds a vented enclosure (the driver is placed in a cabinet); and the [Loudspeaker Driver in 3D — Frequency-Domain Analysis](#) model solves a full electro-vibroacoustic multiphysics version of the driver in 3D.

The model is set up with a combination of the *Magnetic Fields* interface from the AC/DC Module and the *Acoustic-Structure Interaction* multiphysics interface from the Acoustics Module. The *Lorentz Coupling* multiphysics feature is used for handling the electromagnetic forces and induced currents over the voice coil. A first optional analysis solves only the electromagnetic part of the problem, with the driver in stand-still. From here, a driving force factor and the blocked voice coil impedance can be extracted and exported. The second analysis is of the full model, including the relevant multiphysics interactions all the way from the driving voltage to the computed sound pressure level.

A third optional analysis shows what is the effect of not considering the thermoviscous losses in the voice coil gap area. These losses are relevant around the frequencies where back cavity modes appear. The fourth and final analysis is an eigenfrequency analysis of the structure, showing the frequency and shape of the main structural modes of the speaker.

Note: This model requires the both the Acoustics Module and the AC/DC Module.

Model Definition

[Figure 1](#) shows the geometry of the baffled driver with its functional parts. The field from the *magnet* is supported and focused by the iron *pole piece* and *top plate* to the thin gap

where the *voice coil* is wound around a former extending from the apex of the *cone*. Although the voice coil consists of many turns of wire, it is for simplicity drawn and modeled as a homogenized domain. When a driving AC voltage is applied to the voice coil, the resulting force causes it to vibrate, and the cone to create sound.

The *dust cap* protects the magnetic motor. In this design, it is made of the same stiff and light composite material as the cone and also contributes to the sound. A centered hole in the pole piece counteracts pressure buildup beneath the dust cap. The *suspension*, consisting of the *surround*, made of a light foam material, and the *spider*, a flexible cloth, keep the cone in place and provide damping and spring forces.

The outer perimeters of the magnet and suspension are normally attached to a *basket*, a hollow supporting metal structure. The basket is not included in this model, but the magnet assembly and outer rims of the spider and surround are considered to be fixed. The omission of the basket means that the considered geometry is rotationally symmetric and can be modeled in the *rz*-plane.

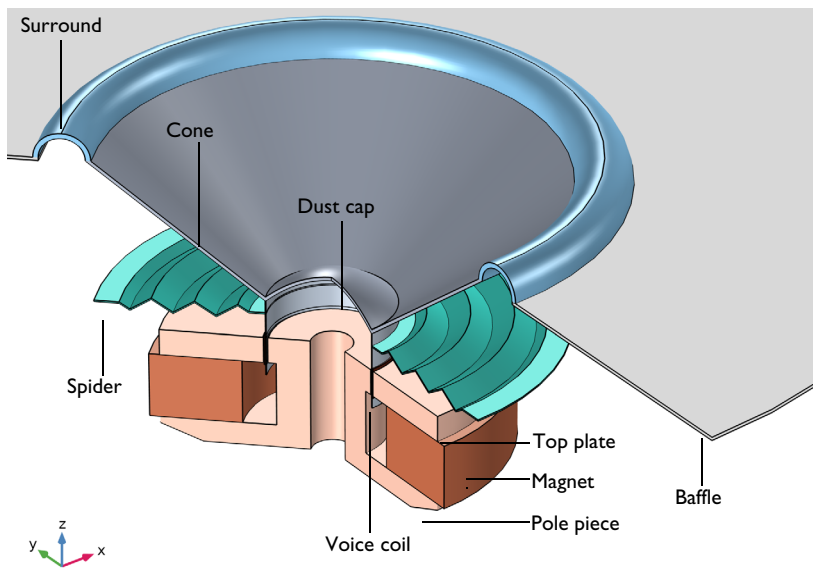

Figure 1: Geometry of the modeled loudspeaker driver.

The loudspeaker is driven by a time-harmonic voltage, $V = V_0 \exp(i\omega t)$, applied to the voice coil. The following theory section first describes the electromagnetic analysis of the current in the voice coil and the driving force that this current gives rise to. The relation

between the driving voltage and the force on the voice coil as well as the so-called back EMF are easily set up in COMSOL using built-in functionality. This force is then applied in an acoustic-structure interaction analysis to compute the sound generation. More details are given in the section [Electromagnetic Interactions](#).

The structural equation is solved in the moving parts of the driver, and a pressure acoustics equation in the surrounding air. The pressure acoustics equation is automatically excited by the structural vibrations, and feeds back the pressure load onto the structure, using the built-in *Acoustic-Structure Boundary* multiphysics coupling. In the narrow gap between the pole piece and the voice coil (the magnetic gap) damping occurs due to thermal and viscous boundary-layer losses. These losses are captured here using the *Narrow Region Acoustics* feature available in pressure acoustics. The gap is well approximated by a slit of constant cross section area. The effect of the damping is illustrated in the [Results and Discussion](#) section below.

The air domains and the baffle should ideally extend to infinity. To avoid unphysical reflections where you truncate the geometry, you use a perfectly matched layer (PML), as seen in [Figure 2](#). For more information about PMLs in acoustics, see the section *Modeling with the Pressure Acoustics Branch (FEM-Based Interfaces)* in the *Acoustics Module User's Guide*.

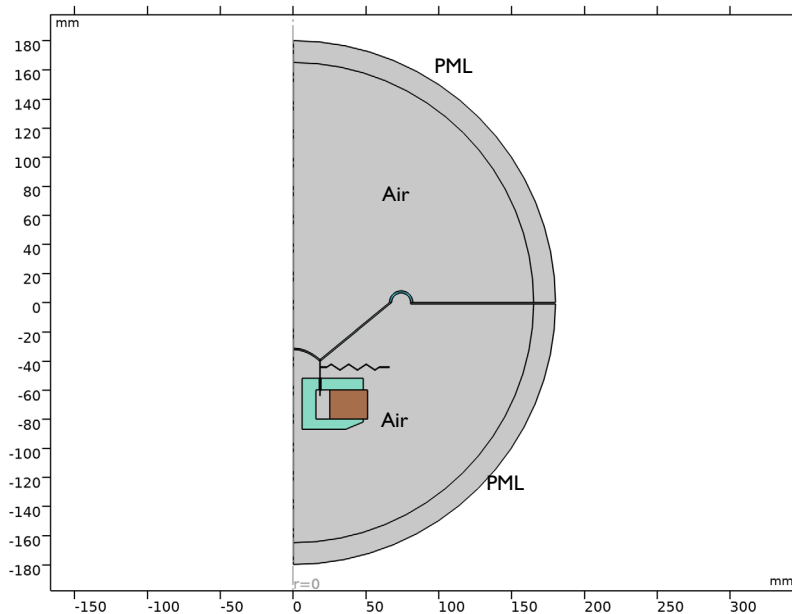

Figure 2: Overview of the model geometry.

Although the modeled air domain has a radius of only 165 mm, the local acoustic pressure and phase can be extracted anywhere outside the computational domain by using the exterior-field pressure computations. The sensitivity is calculated as the sound pressure level on the axis at a radius of 1 m, for the applied voltage $V_0 = 3.55$ V. This functionality also allows postprocessing the directivity plot for the speaker, again evaluated at 1 m.

ELECTROMAGNETIC INTERACTIONS

The Lorentz force on a wire of length L and with the current \mathbf{I} in an externally generated magnetic flux density \mathbf{B} perpendicular to the wire is given by $\mathbf{F} = L\mathbf{I} \times \mathbf{B}$. The voice coil consists of a single copper wire making $N_0 = 100$ turns. The coil is homogenized so that

$$N_0 I = \int_A \mathbf{J}_\varphi dA$$

where \mathbf{J}_φ is the azimuthally directed current density through a cross-section of the coil, and the integral is taken over its area in the rz -plane. The total driving force on the coil hence becomes

$$\mathbf{F}_e = - \int_V \mathbf{J}_\varphi B_r dV \quad (1)$$

with B_r being the r -component of the magnetic flux density, and the integral evaluated over the volume occupied by the coil domain. The Lorentz force is applied to the voice coil through the *Lorentz Coupling* multiphysics feature.

The current through the voice coil relates to the applied voltage as

$$I = (V_0 + V_{be}) / Z_b \quad (2)$$

where Z_b is the *blocked electric impedance* (the electric impedance of the voice coil measured while the speaker's moving parts are stationary) and $-V_{be}$ denotes the *back EMF* (the voltage induced in the coil due to its motion through the permanent magnetic field in the gap). The back EMF is also automatically added to the voice coil using the *Lorentz Coupling* multiphysics feature.

EXPORT OF LUMPED ELECTROMAGNETIC PARAMETERS

Lumped parameters that represent the driver can be derived and used for larger system simulations. The force factor BL and the blocked electric impedance of the coil are computed. They are used in the [Loudspeaker Driver in a Vented Enclosure](#) tutorial model to set up a lumped electromagnetic equivalent to drive the speaker.

If you write [Equation 1](#) in terms of the coil current I rather than the cross-sectional current density, you get

$$F_e = -\frac{2\pi IN_0}{A} \int r B_r dA \quad (3)$$

as it is assumed that $\mathbf{J}_\phi = I \cdot \mathbf{N}_0 / A$ and is constant in the coil cross-section of area A . The common factor in the expression for F_e and V_{be} is the force factor BL , defined as

$$BL = -\frac{2\pi N_0}{A} \int r B_r dA \quad (4)$$

Note that if $A \rightarrow 0$, the integral becomes equal to a magnetic flux density times the length of the coil; hence the name.

With knowledge of BL and the frequency-dependent Z_b , [Equation 2](#), [Equation 3](#), and [Equation 4](#) can be rearranged to form a relationship between the driving voltage V_0 and the force acting on the voice coil

$$F_e = \frac{BL V_0}{Z_b} - v \frac{(BL)^2}{Z_b}$$

This is the expression used as the driving force in the [Loudspeaker Driver in a Vented Enclosure](#) model. Note the dependence on the velocity v of the moving coil, which is unknown prior to modeling the acoustic-structure interaction (ASI) problem.

Results and Discussion

The magnetic field in and around the magnetic motor is depicted in [Figure 3](#). The maximum field in the air arises in the gap between the pole piece and the top plate (the magnetic gap where the voice coil is located). Performing the integral in [Equation 4](#) over the voice coil domain gives a force factor $BL = 10.48 \text{ N/A}$.

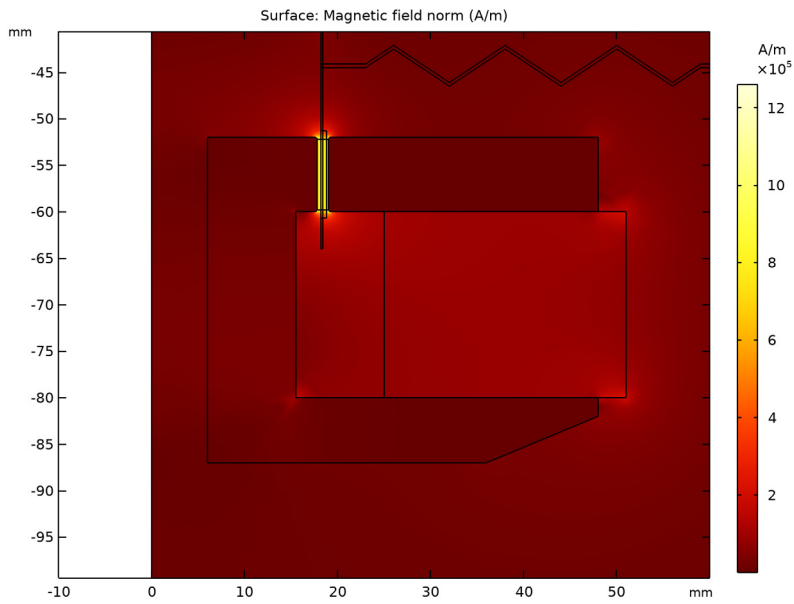

Figure 3: Magnetic field in and around the magnetic motor.

The iron in the pole piece and the top plate is modeled as a nonlinear magnetic material, with the relationship between the \mathbf{B} and \mathbf{H} fields described by interpolation from measured data. [Figure 4](#) shows the local effective relative permeability $\mu_r = \mathbf{B}/(\mu_0\mathbf{H})$. The plot shows that the iron is close to saturation in the center of the pole piece, but remains in the linear regime above and below the magnet. This indicates that if you want to use less material, you can likely decrease the radius of the pole piece and top plate with very little effect on the magnetic field in the gap.

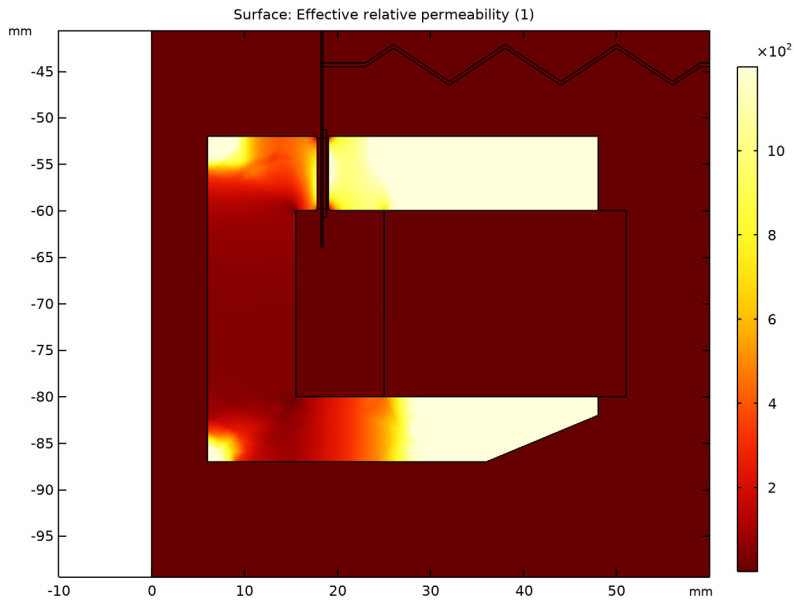

Figure 4: The local relative permeability in the pole piece and top plate, when subjected to the field from the magnet.

In computing the blocked coil impedance, the AC equation is linearized around the local permeability resulting from the static solution. [Figure 5](#) shows the induced currents at a frequency of 50 Hz and 900 Hz. With increasing frequency, it is evident that the so-called skin depth decreases as expected.

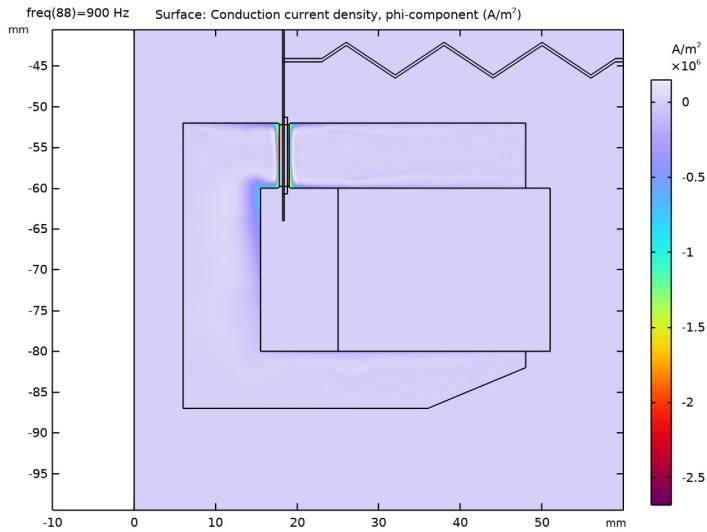
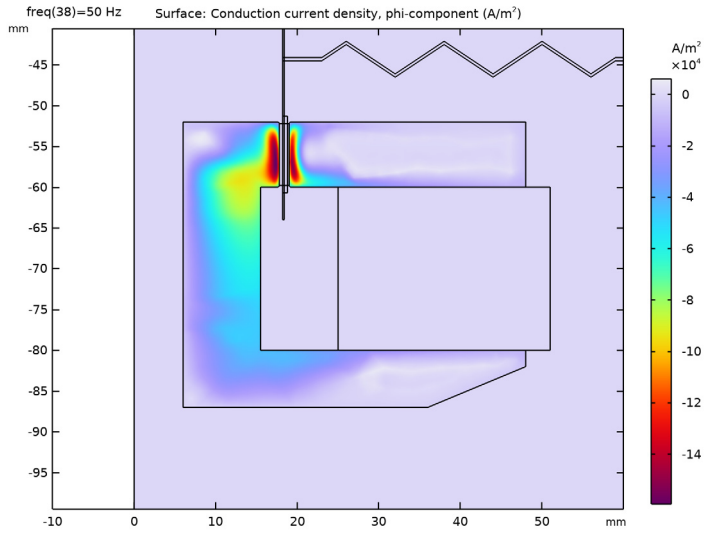

Figure 5: Induced currents in the pole piece and top plate at 50 Hz (top) and 900 Hz (bottom).

As seen at the higher frequency in [Figure 5](#), the skin effect brings the currents closer to the surfaces. This causes the inductance as well as the resistive part of the impedance to change with the frequency. [Figure 6](#) shows a plot of the blocked coil inductance versus frequency.

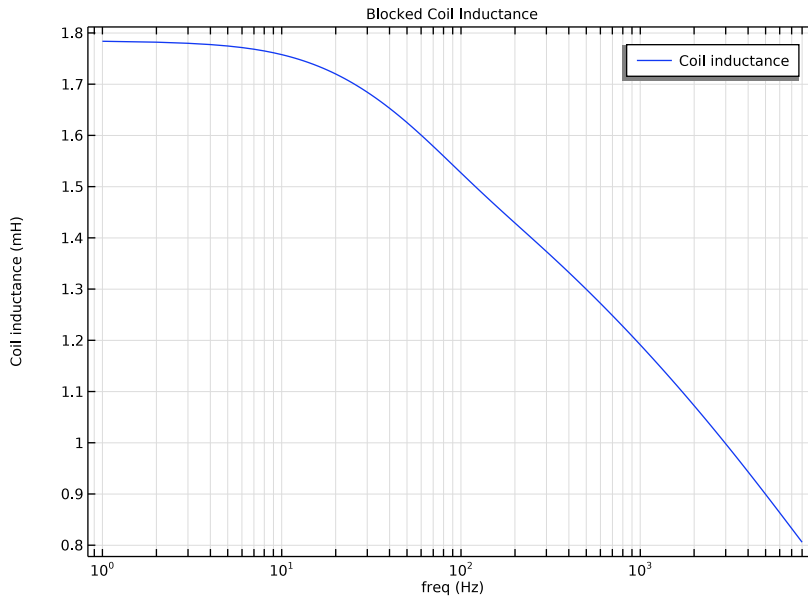

Figure 6: The inductance of the blocked coil as a function of frequency.

From the full electroacoustic-structure interaction analysis, [Figure 7](#) shows the sound pressure level and displacement distribution at 8000 Hz. As the frequency of the excitation increases, it becomes possible to excite structural modes where different parts of the cone move at phases differing more than $\pm 90^\circ$. This effect, called cone breakup, reduces the acoustic efficiency of the speaker, as different parts of the cone will produce acoustic pressures of opposite sign. Using an eigenfrequency study pinpoints at which frequencies the different breakup modes appear. At lower frequencies, the sound pressure level is rather evenly distributed with peaks in the on-axis direction.

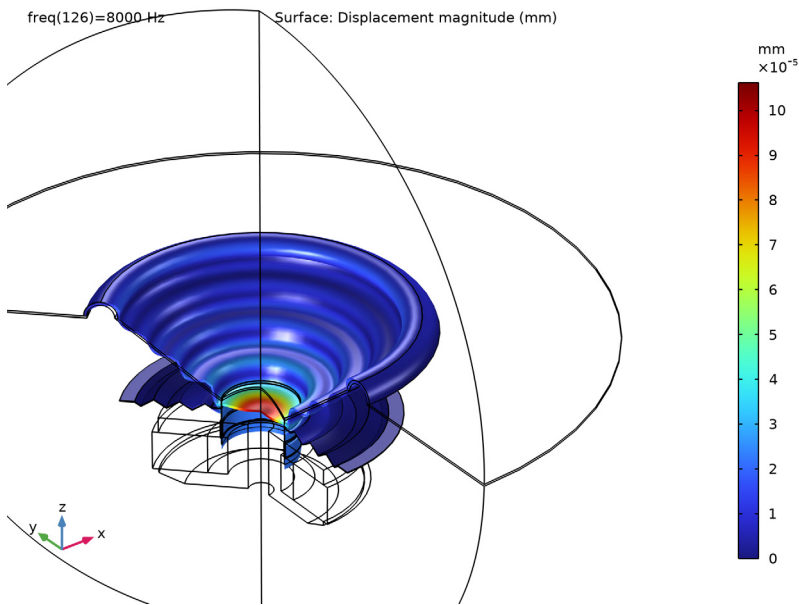
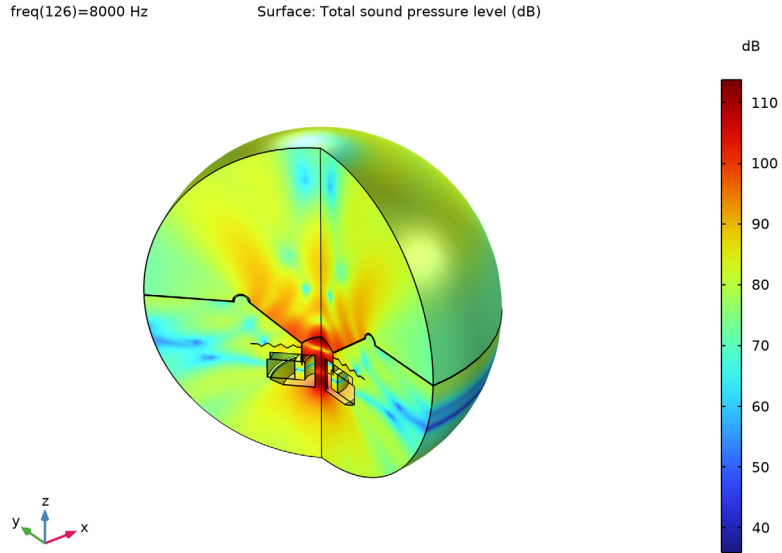

Figure 7: Sound pressure level (top) and displacement distribution (bottom) at 8000 Hz.

Figure 8 presents the loudspeaker’s sensitivity depicted both in 1/3 octave bands and as a continuous curve. The plot is realized using the specialized *Octave Band* plot available in the Acoustics Module. The preferred operating range is where the response is rather flat — that is, roughly in the range 100 Hz–1500 Hz. A vented enclosure can extend the range to lower frequencies, as shown in the tutorial model [Loudspeaker Driver in a Vented Enclosure](#).

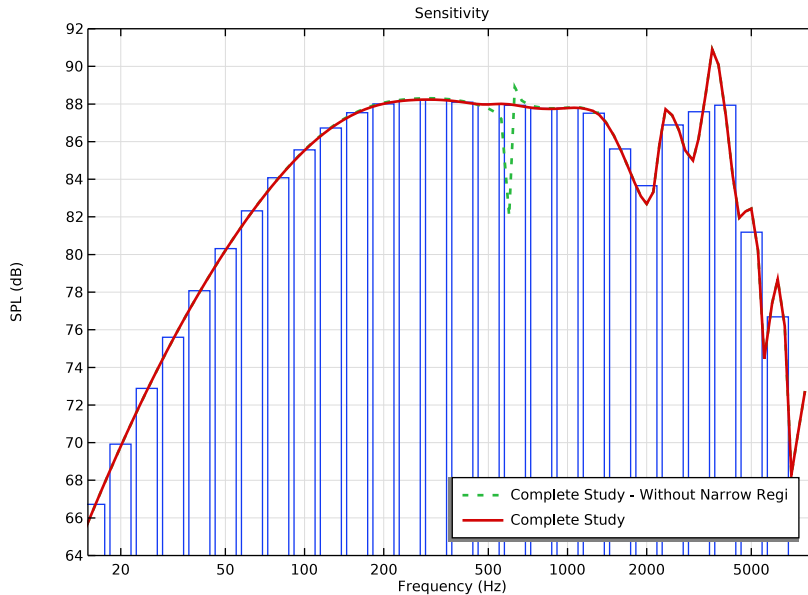

Figure 8: Loudspeaker sensitivity, measured as the on-axis sound pressure level (dB) at a distance of 1 m from the unit. The pressure is evaluated using an input signal of 3.55 V, or 2.51 V RMS, which corresponds to a power of 1 W at an 6.3 Ω . nominal impedance. Note the logarithmic frequency scale.

The plot in Figure 8 also shows the damping effect of the thermoviscous losses in the narrow gap between the voice coil and pole piece/top plate. In this setup one of the boundaries is moving (the voice coil), which is not fully compatible with the narrow region acoustics that assumes fixed boundaries. The error made is small. This can be seen by using the full thermoviscous acoustic physics interface in the narrow domain. The sensitivity is plotted both with (red curve) and without (green dotted) the losses included, captured using the *Narrow Region Acoustics* feature. If these are not considered, the back cavity mode around 600 Hz, will be shown in the sensitivity curve as steep resonances (green dotted curve). This mode can also be identified through the sudden shift of phase in the back cavity pressure as depicted in Figure 9.

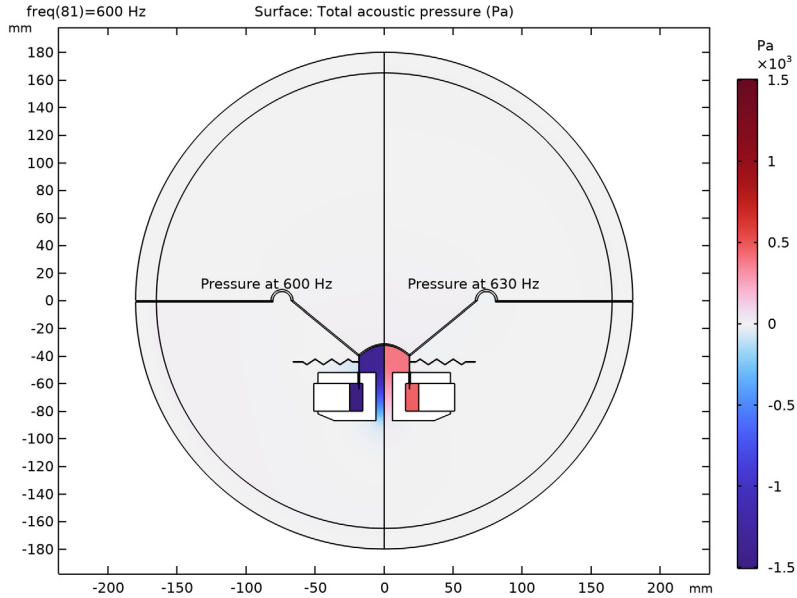

Figure 9: Acoustic pressure below and above the back cavity mode for the lossless model.

The total electric impedance, defined as $Z = V_0/I$, is depicted in Figure 10 (absolute, real, and imaginary parts are plotted). The features of this plot are very characteristic of loudspeaker drivers. The peak at approximately 50 Hz coincides with the mechanical resonance; at this frequency the reactive part of the impedance switches sign from inductive to capacitive. In most of the operational range the impedance is largely resistive. Between 100 Hz and 1 kHz it varies only between 6.3 Ω and 10.4 Ω . These are typical values for speakers with a nominal impedance of 6.3 Ω , as the nominal impedance is usually taken to represent a mean value over the usable frequency range, which for this driver extends between somewhat below 100 Hz and above 1 kHz. The DC resistance is the value as the frequency goes to 0 Hz, it has a value of 5.6 Ω . At frequencies higher than 1 kHz, the impedance continues to increase as the inductance of the voice coil starts playing a more important part.

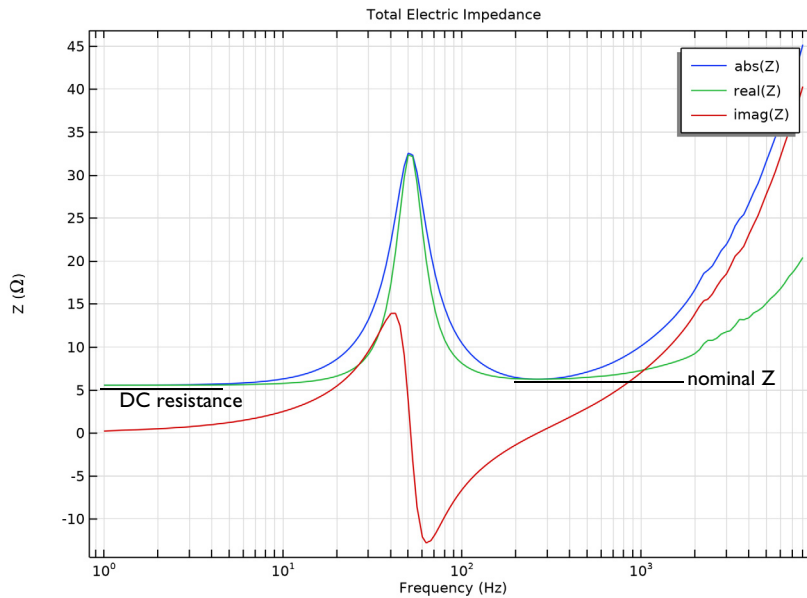

Figure 10: Electric impedance (Ω) of the loudspeaker as a function of frequency (Hz).

The deformation of the speaker depicted in Figure 7 indicates that one or more breakup modes are active at high frequencies. The eigenfrequency analysis performed in the last study step shows the main mode affecting the structure. Due to the small influence of the acoustic pressure or the magnetic field in the frequency at which these modes appear, the analysis considers only the *Solid Mechanics* physics (the structure). The main modes, depicted in Figure 11, show that the first mode of the speaker appears slightly above 50 Hz, while the first breakup mode appears at around 2350 Hz. In the present case, only rotationally symmetric breakups can be modeled (the speaker is analyzed in 3D in the [Loudspeaker Driver in a Vented Enclosure](#) model).

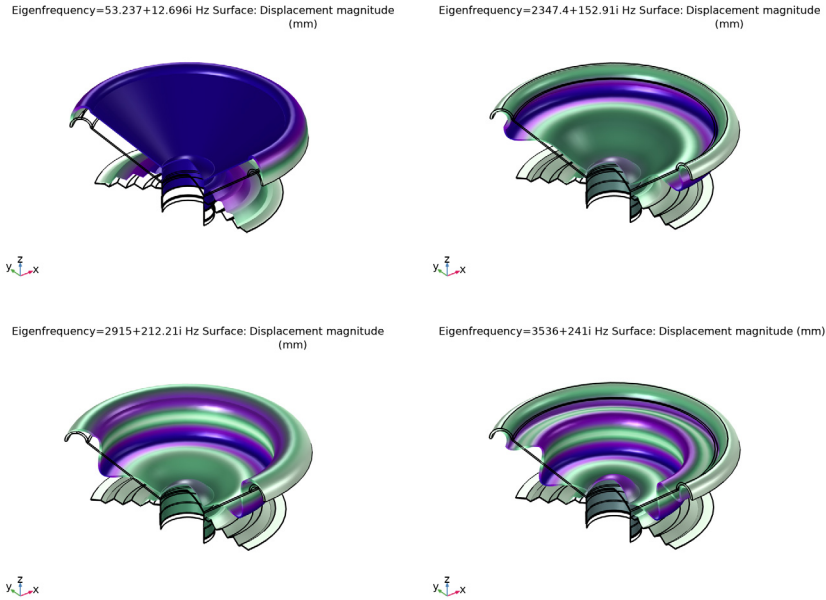

Figure 11: Main structural modes of the loudspeaker driver.

Figure 12, finally, shows a directivity plot of the spatial speaker response. This is created using the dedicated *Directivity* plot available with the Acoustics Module. The plot shows a contour representation of the spatial response (measured on a half sphere in front of the speaker) versus the frequency. Directivity plots help analyze when sidelobes occur and how they fall off. Several options, for example for the normalization and for switching the axes, are included. The plot in Figure 12 is normalized with respect to the level at 0° .

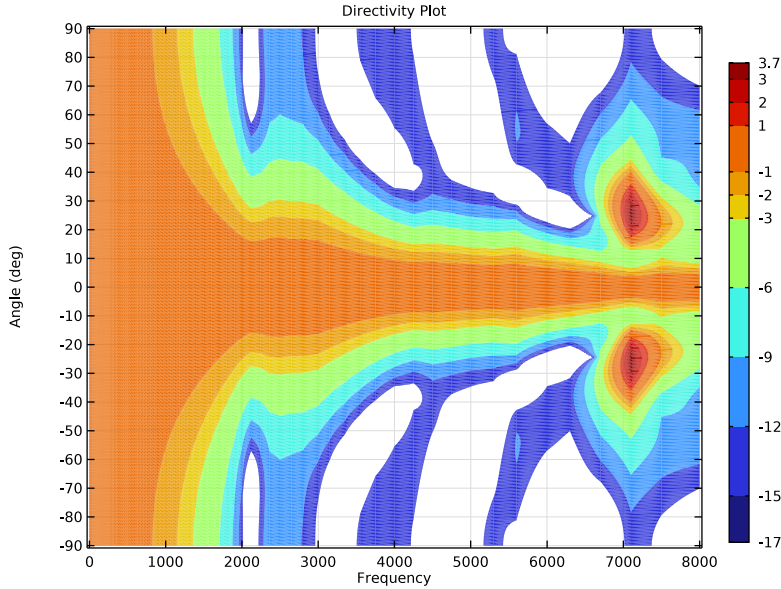

Figure 12: Directivity plot of the spatial speaker response.

Notes About the COMSOL Implementation

The step-by-step instructions take you through the following steps:

- Import the geometry and enter model parameters.
- Apply material settings.
- Set up the physics.
- Create a study computing first the static magnetic field from the permanent magnet, then the time-harmonic fields created by the voice coil over a range of frequencies.
- (Optional) Run the study to extract the force factor, BL , and the blocked coil impedance, Z_b .
- Copy and extend the study to include the acoustic-structure interaction.
- Solve to compute the sound pressure level and the total electric impedance of the driver over the same frequency range.

- (Optional) Set up a study considering all the physics but disable the *Narrow Region Acoustics* features.
- (Optional) Create and run an eigenfrequency analysis to locate the main structural modes of the loudspeaker.

POLE PIECE AND TOP PLATE MATERIAL

The iron used in the pole piece and top plate is a nonlinear magnetic material, with interpolation data describing the relationship between the B and H fields. Among other output, the static solution provides the local permeability, as shown in [Figure 4](#).

PERTURBATION ANALYSIS

The studies in this model have a Stationary study step followed by a Frequency Domain, Perturbation step. This automatically makes the stationary solution the linearization point for the subsequent frequency domain solution. This means that the Magnetic Fields interface derives and uses a differential permeability inherited from the one computed by the stationary study. For the frequency domain assumption to be strictly valid, the applied AC voltage must be so small that the resulting current creates a magnetic field which does not significantly alter this permeability. Even though this is not quite the situation here, linearizing around a local biased permeability should still be a better approximation than assuming a constant permeability. The most accurate way to compute the impedance would be in a fully transient analysis, which is outside the scope of this model.

The coil is driven with a voltage set to `linper(V0)`. The `linper()` operator ensures that the driving voltage $V0$ is applied only in the Frequency Domain, Perturbation study step.

MULTIPHYSICS

The *Acoustic-Structure Interaction* multiphysics interface sets up the pressure acoustics and the solid mechanics interfaces together with the *Acoustic-Structure Boundary* multiphysics coupling. The multiphysics coupling (under the *Multiphysics* node) automatically provides and assigns the boundary conditions for the two-way acoustic-structural coupling between the air and the structures. The acoustic-structure interaction is solved for only in the Frequency Domain, Perturbation step.

The *Lorentz Coupling* multiphysics feature automatically provides and assigns the domain loads for the two-way electromagnetic-structural coupling in the coil domain.

STRUCTURAL DAMPING

In most loudspeaker specifications, the suspension is characterized by a mechanical compliance C_s and resistance R_s . In order to keep the resistance constant over a range of frequencies, the material needs to have a damping factor that increases linearly with the

frequency or, equivalently, Rayleigh damping with $\alpha_{\delta M} = 0$ and a constant $\beta_{dK} = \eta/\omega_{\text{loss}}$, where η is the loss factor measured at the angular frequency ω_{loss} . In this model, the frequency where the loss factor is measured is chosen to be near the lowest mechanical resonance of the driver.

Application Library path: Acoustics_Module/Electroacoustic_Transducers/loudspeaker_driver

Note: This application also requires the file Acoustics_Module/Electroacoustic_Transducers/loudspeaker_driver_materials as it contains the material definitions for Materials.



Modeling Instructions

From the **File** menu, choose **New**.

NEW

In the **New** window, click  **Model Wizard**.



MODEL WIZARD

- 1 In the **Model Wizard** window, click  **2D Axisymmetric**.
- 2 In the **Select Physics** tree, select **AC/DC** > **Electromagnetic Fields** > **Magnetic Fields (mf)**.
- 3 Click **Add**.
- 4 In the **Select Physics** tree, select **Acoustics** > **Acoustic-Structure Interaction** > **Acoustic-Solid Interaction, Frequency Domain**.
- 5 Click **Add**.
- 6 Click  **Study**.

The Model Wizard lets you select the first one of the study steps you plan to use in the model. Select a stationary study used for solving the static magnetic fields.
- 7 In the **Select Study** tree, select **Preset Studies for Some Physics Interfaces** > **Stationary**.
- 8 Click  **Done**.

GEOMETRY I

When working with your own modeling project of an acoustic driver, you will typically either draw the geometry in COMSOL Multiphysics, or import a CAD file of the driver itself and add the surrounding air and PML domains. Here, the entire geometry is imported as a sequence from the geometry file. The instructions to the geometry can be found in the appendix at the end of this document.

- 1 In the **Geometry** toolbar, click **Insert Sequence** and choose **Insert Sequence**.
- 2 Browse to the model's Application Libraries folder and double-click the file `loudspeaker_driver_geom_sequence.mph`.
- 3 In the **Geometry** toolbar, click  **Build All**.
- 4 Click the  **Zoom Extents** button in the **Graphics** toolbar.

GLOBAL DEFINITIONS

Parameters I

Enter the model parameters or load them from the file `loudspeaker_driver_parameters.txt`. Here, as well as in all following sections, the Description field helps you keep track of what you are doing, but is completely optional.

- 1 In the **Model Builder** window, under **Global Definitions** click **Parameters I**.
- 2 In the **Settings** window for **Parameters**, locate the **Parameters** section.
- 3 In the table, enter the following settings:

Name	Expression	Value	Description
N0	100	100	Number of turns in coil
V0	3.55[V]	3.55 V	Peak driving voltage
f_loss	40[Hz]	40 Hz	Frequency at which loss factor is given
omega_loss	2*pi*f_loss	251.33 Hz	Angular frequency at which loss factor is given
fmax	8[kHz]	8000 Hz	Maximal study frequency
c0	343[m/s]	343 m/s	Speed of sound in air
lam0	c0/fmax	0.042875 m	Minimum wave length

The loss factor frequency definition `f_loss` will be used when setting up the structural damping properties.

Create some selections, this will simplify setting up the physics.

DEFINITIONS

Soft Iron

- 1 In the **Definitions** toolbar, click  **Explicit**.
- 2 In the **Settings** window for **Explicit**, type Soft Iron in the **Label** text field.
- 3 Select Domains 6 and 23 only.
- 4 Locate the **Color** section. From the **Color** list, choose **Color 3**.

Composite

- 1 In the **Definitions** toolbar, click  **Explicit**.
- 2 In the **Settings** window for **Explicit**, type Composite in the **Label** text field.
- 3 Select Domains 3 and 21 only.
- 4 Locate the **Color** section. From the **Color** list, choose **Color 9**.

Cloth

- 1 In the **Definitions** toolbar, click  **Explicit**.
- 2 In the **Settings** window for **Explicit**, type Cloth in the **Label** text field.
- 3 Select Domain 20 only.
- 4 Locate the **Color** section. From the **Color** list, choose **Color 7**.

Foam

- 1 In the **Definitions** toolbar, click  **Explicit**.
- 2 In the **Settings** window for **Explicit**, type Foam in the **Label** text field.
- 3 Select Domain 25 only.
- 4 Locate the **Color** section. From the **Color** list, choose **Color 10**.

Coil

- 1 In the **Definitions** toolbar, click  **Explicit**.
- 2 In the **Settings** window for **Explicit**, type Coil in the **Label** text field.
- 3 Select Domains 17–19 only.
- 4 Locate the **Color** section. From the **Color** list, choose **Color 8**.

Glass Fiber

- 1 In the **Definitions** toolbar, click  **Explicit**.
- 2 In the **Settings** window for **Explicit**, type Glass Fiber in the **Label** text field.
- 3 Select Domains 9–16 only.
- 4 Locate the **Color** section. From the **Color** list, choose **Color 10**.

Generic Ferrite

- 1 In the **Definitions** toolbar, click  **Explicit**.
- 2 In the **Settings** window for **Explicit**, type Generic Ferrite in the **Label** text field.
- 3 Select Domain 24 only.
- 4 Locate the **Color** section. From the **Color** list, choose **Color 17**.

PML

- 1 In the **Definitions** toolbar, click  **Explicit**.
- 2 In the **Settings** window for **Explicit**, type PML in the **Label** text field.
- 3 Select Domains 1 and 5 only.

All Domains

- 1 In the **Definitions** toolbar, click  **Box**.
- 2 In the **Settings** window for **Box**, type All Domains in the **Label** text field.

Air

- 1 In the **Definitions** toolbar, click  **Difference**.
- 2 In the **Settings** window for **Difference**, type Air in the **Label** text field.
- 3 Locate the **Input Entities** section. Under **Selections to add**, click **+ Add**.
- 4 In the **Add** dialog, select **All Domains** in the **Selections to add** list.
- 5 Click **OK**.
- 6 In the **Settings** window for **Difference**, locate the **Input Entities** section.
- 7 Under **Selections to subtract**, click **+ Add**.
- 8 In the **Add** dialog, in the **Selections to subtract** list, choose **Soft Iron, Composite, Cloth, Foam, Coil, Glass Fiber, and Generic Ferrite**.
- 9 Click **OK**.

Structural Domains

- 1 In the **Definitions** toolbar, click  **Union**.
- 2 In the **Settings** window for **Union**, type Structural Domains in the **Label** text field.
- 3 Locate the **Input Entities** section. Under **Selections to add**, click **+ Add**.
- 4 In the **Add** dialog, in the **Selections to add** list, choose **Composite, Cloth, Foam, Coil, and Glass Fiber**.
- 5 Click **OK**.

Composite and Glass Fiber

- 1 In the **Definitions** toolbar, click  **Union**.
- 2 In the **Settings** window for **Union**, type **Composite** and **Glass Fiber** in the **Label** text field.
- 3 Locate the **Input Entities** section. Under **Selections to add**, click **+ Add**.
- 4 In the **Add** dialog, in the **Selections to add** list, choose **Composite** and **Glass Fiber**.
- 5 Click **OK**.

Magnetic Domains

- 1 In the **Definitions** toolbar, click  **Box**.
- 2 In the **Settings** window for **Box**, type **Magnetic Domains** in the **Label** text field.
- 3 Locate the **Box Limits** section. In the **r minimum** text field, type **0[mm]**.
- 4 In the **r maximum** text field, type **50[mm]**.
- 5 In the **z minimum** text field, type **-90[mm]**.
- 6 In the **z maximum** text field, type **-42[mm]**.

All Domains Without the PML

- 1 In the **Definitions** toolbar, click  **Difference**.
- 2 In the **Settings** window for **Difference**, type **All Domains Without the PML** in the **Label** text field.
- 3 Locate the **Input Entities** section. Under **Selections to add**, click **+ Add**.
- 4 In the **Add** dialog, select **All Domains** in the **Selections to add** list.
- 5 Click **OK**.
- 6 In the **Settings** window for **Difference**, locate the **Input Entities** section.
- 7 Under **Selections to subtract**, click **+ Add**.
- 8 In the **Add** dialog, select **PML** in the **Selections to subtract** list.
- 9 Click **OK**.

Perfectly Matched Layer 1 (pml1)

- 1 In the **Definitions** toolbar, click  **Perfectly Matched Layer**.
Use the Perfectly Matched Layers (PMLs) to model a nonreflecting condition-like behavior and avoid unphysical reflections (spurious reflections) where the sound leaves the model. This feature is also set up under **Definitions**. This makes them available for any physics interface that needs them.
- 2 In the **Settings** window for **Perfectly Matched Layer**, locate the **Domain Selection** section.

- 3 From the **Selection** list, choose **PML**.
- 4 Locate the **Scaling** section. In the **PML scaling curvature parameter** text field, type 3.

Integration 1 (intop1)

- 1 In the **Definitions** toolbar, click  **Nonlocal Couplings** and choose **Integration**.

Use this integral to compute the radiated power of the loudspeaker.

- 2 In the **Settings** window for **Integration**, locate the **Source Selection** section.
- 3 From the **Geometric entity level** list, choose **Boundary**.
- 4 Select Boundary 93 only.

Variables 1

- 1 In the **Model Builder** window, right-click **Definitions** and choose **Variables**.

Add two variables to compute the acoustic efficiency of the loudspeaker. The coil power exists as a predefined results variable.

- 2 In the **Settings** window for **Variables**, locate the **Variables** section.
- 3 In the table, enter the following settings:

Name	Expression	Unit	Description
coil_power	mf.PCoil_1		Coil power
aco_eff	$-\text{intop1}(\text{up}(\text{acpr.Ir}) * \text{nr} + \text{up}(\text{acpr.Iz}) * \text{nz}) / \text{coil_power}$		Acoustic efficiency

MATERIALS

While the material properties used in this model are partly made up, they resemble those used in a real driver. The coil former has properties representative of glass fiber materials. The spider, acting as a spring, is made of a phenolic cloth with a much lower stiffness. The material used in the coil is taken to be lighter than copper, as the wire is insulated and does not completely fill the coil domain. The surround, finally, is a light resistive foam.

Except for air and soft Iron, the materials you will use all come from a material library created especially for this model (to be loaded from the file `loudspeaker_driver_materials.mph`). You may notice that some of the materials will report missing properties. For example, the composite does not include any electromagnetic properties. This is fine, as you will not model the magnetic fields in the domains where the composite is used.

ADD MATERIAL

- 1 In the **Materials** toolbar, click  **Add Material** to open the **Add Material** window.

- 2 Go to the **Add Material** window.
- 3 In the tree, select **Built-in > Air**.
- 4 Click the **Add to Component** button in the window toolbar.
- 5 In the tree, select **AC/DC > Soft Iron (With Losses)**.
- 6 Click the **Add to Component** button in the window toolbar.

MATERIALS

Air (mat1)

First, add air which will be present everywhere in your geometry. Next, switch to using nonlinear Iron in the pole piece and top plate.



Soft Iron (With Losses) (mat2)

- 1 In the **Model Builder** window, click **Soft Iron (With Losses) (mat2)**.
- 2 In the **Settings** window for **Material**, locate the **Geometric Entity Selection** section.
- 3 From the **Selection** list, choose **Soft Iron**.
- 4 Right-click **Soft Iron (With Losses) (mat2)** and choose **Browse Materials**.

MATERIAL BROWSER

- 1 In the **Material Browser** window, In the ribbon make sure to select the **Materials** tab and then click the **Browse Materials** icon.

The **Import Material Library** functionality is activated by clicking the small icon at the lower-right, below the Material Browser tree.

- 2 click  **Import Material Library**.
- 3 Browse to the model's Application Libraries folder and double-click the file `loudspeaker_driver_materials.mph`.
- 4 Click  **Done**.

ADD MATERIAL

- 1 Go to the **Add Material** window.
- 2 In the tree, select **loudspeaker driver materials > Composite**.
- 3 Click the **Add to Component** button in the window toolbar.
- 4 In the tree, select **loudspeaker driver materials > Cloth**.
- 5 Click the **Add to Component** button in the window toolbar.
- 6 In the tree, select **loudspeaker driver materials > Foam**.
- 7 Click the **Add to Component** button in the window toolbar.

- 8 In the tree, select **loudspeaker driver materials** > **Coil**.
- 9 Click the **Add to Component** button in the window toolbar.
- 10 In the tree, select **loudspeaker driver materials** > **Glass Fiber**.
- 11 Click the **Add to Component** button in the window toolbar.
- 12 In the tree, select **loudspeaker driver materials** > **Generic Ferrite**.
- 13 Click the **Add to Component** button in the window toolbar.
- 14 In the **Materials** toolbar, click  **Add Material** to close the **Add Material** window.

MATERIALS

Composite (mat3)

- 1 In the **Settings** window for **Material**, locate the **Geometric Entity Selection** section.
- 2 From the **Selection** list, choose **Composite**.

Cloth (mat4)

- 1 In the **Model Builder** window, click **Cloth (mat4)**.
- 2 In the **Settings** window for **Material**, locate the **Geometric Entity Selection** section.
- 3 From the **Selection** list, choose **Cloth**.

Foam (mat5)

- 1 In the **Model Builder** window, click **Foam (mat5)**.
- 2 In the **Settings** window for **Material**, locate the **Geometric Entity Selection** section.
- 3 From the **Selection** list, choose **Foam**.

Coil (mat6)

- 1 In the **Model Builder** window, click **Coil (mat6)**.
- 2 In the **Settings** window for **Material**, locate the **Geometric Entity Selection** section.
- 3 From the **Selection** list, choose **Coil**.

Glass Fiber (mat7)

- 1 In the **Model Builder** window, click **Glass Fiber (mat7)**.
- 2 In the **Settings** window for **Material**, locate the **Geometric Entity Selection** section.
- 3 From the **Selection** list, choose **Glass Fiber**.

Generic Ferrite (mat8)

- 1 In the **Model Builder** window, click **Generic Ferrite (mat8)**.
- 2 In the **Settings** window for **Material**, locate the **Geometric Entity Selection** section.

- 3 From the **Selection** list, choose **Generic Ferrite**.

MAGNETIC FIELDS (MF)

The Magnetic Fields equation needs to be solved in and around the magnetic motor. To reduce simulation time, make this physics interface active only where it is needed. You can remove all domains where you expect the magnetic field to be negligible.

- 1 In the **Model Builder** window, under **Component 1 (comp1)** click **Magnetic Fields (mf)**.
- 2 In the **Settings** window for **Magnetic Fields**, locate the **Domain Selection** section.
- 3 From the **Selection** list, choose **Magnetic Domains**.

Add an instance of the **Ampère's Law in Solids** domain feature in all Magnetic Fields domains, where the material is different from air.

Ampère's Law in Solids - Generic Ferrite

- 1 In the **Physics** toolbar, click  **Domains** and choose **Ampère's Law in Solids**.
- 2 In the **Settings** window for **Ampère's Law in Solids**, type Ampère's Law in Solids - Generic Ferrite in the **Label** text field.
- 3 Locate the **Domain Selection** section. From the **Selection** list, choose **Generic Ferrite**.
- 4 Locate the **Constitutive Relation B-H** section. From the **Magnetization model** list, choose **Remanent flux density**.
- 5 Specify the **e** vector as

0	r
0	phi
1	z

This setting gives a static remanent flux density equal to 0.4 T in the z direction. This will create a static magnetic field distribution in the model, providing the linearization point for the frequency domain study.

Ampère's Law in Solids - Soft Iron

- 1 In the **Physics** toolbar, click  **Domains** and choose **Ampère's Law in Solids**.
- 2 In the **Settings** window for **Ampère's Law in Solids**, type Ampère's Law in Solids - Soft Iron in the **Label** text field.
- 3 Locate the **Domain Selection** section. From the **Selection** list, choose **Soft Iron**.
- 4 Locate the **Constitutive Relation B-H** section. From the **Magnetization model** list, choose **B-H curve**.

The B-H curve is provided by the soft iron material.

Ampère's Law in Solids - Nonconductive Solids

- 1 In the **Physics** toolbar, click  **Domains** and choose **Ampère's Law in Solids**.
- 2 In the **Settings** window for **Ampère's Law in Solids**, locate the **Domain Selection** section.
- 3 From the **Selection** list, choose **Structural Domains**.
- 4 In the **Label** text field, type Ampère's Law in Solids - Nonconductive Solids.

Coil 1

- 1 In the **Physics** toolbar, click  **Domains** and choose **Coil**.
- 2 In the **Settings** window for **Coil**, locate the **Domain Selection** section.
- 3 From the **Selection** list, choose **Coil**.
- 4 Locate the **Coil** section. From the **Conductor model** list, choose **Homogenized multiturn**.
- 5 Locate the **Homogenized Conductor** section. In the N text field, type $N0$.
- 6 From the list, choose **User defined**.
- 7 Find the **High-frequency effective loss** subsection. Clear the **Include harmonic loss** checkbox.
- 8 In the a text field, type $3.5e-8[m^2]$.
With $N0 = 100$ turns, the total cross-sectional area covered by the wires will be $3.5e-6 m^2$. The area of the coil domain is $6e-6 m^2$, making the fill factor approximately 60%.
- 9 Locate the **Coil** section. From the **Coil excitation** list, choose **Voltage**.
- 10 In the V_{coil} text field, type $linper(V0)$.
This is the driving voltage. Because the $linper()$ operator is used it will kick in only in the **Frequency Domain, Perturbation** study.

PRESSURE ACOUSTICS, FREQUENCY DOMAIN (ACPR)

Select the air domains above and under the speaker as well as the PML regions.

- 1 In the **Model Builder** window, under **Component 1 (comp1)** click **Pressure Acoustics, Frequency Domain (acpr)**.
- 2 In the **Settings** window for **Pressure Acoustics, Frequency Domain**, locate the **Domain Selection** section.
- 3 From the **Selection** list, choose **Air**.

Exterior Field Calculation 1

- 1 In the **Physics** toolbar, click  **Boundaries** and choose **Exterior Field Calculation**.
The exterior-field calculation requires a source boundary encompassing all local sound sources, and with a symmetry plane to account for the infinite baffle. After computing

the solution, you can evaluate the pressure in any point (r, z) outside the domain by entering `pext(r, z)`.

- 2 Select Boundary 93 only.
- 3 In the **Settings** window for **Exterior Field Calculation**, locate the **Exterior Field Calculation** section.
- 4 From the **Condition in the $z = z_0$ plane** list, choose **Symmetric/Infinite sound hard boundary**.

The narrow air gaps around the voice coil have a significant effect on the damping of the back cavity modes.

Narrow Region Acoustics 1

- 1 In the **Physics** toolbar, click  **Domains** and choose **Narrow Region Acoustics**.
- 2 Select Domain 8 only.
- 3 In the **Settings** window for **Narrow Region Acoustics**, locate the **Duct Properties** section.
- 4 From the **Duct type** list, choose **Slit**.
- 5 In the h text field, type 0.4[mm].
- 6 Select Domain 8 only.

Narrow Region Acoustics 2

- 1 Right-click **Narrow Region Acoustics 1** and choose **Duplicate**.
- 2 In the **Settings** window for **Narrow Region Acoustics**, locate the **Domain Selection** section.
- 3 Click  **Clear Selection**.
- 4 Select Domain 22 only.
- 5 Locate the **Duct Properties** section. In the h text field, type 0.2[mm].

SOLID MECHANICS (SOLID)

- 1 In the **Model Builder** window, under **Component 1 (comp1)** click **Solid Mechanics (solid)**.
- 2 In the **Settings** window for **Solid Mechanics**, locate the **Domain Selection** section.
- 3 From the **Selection** list, choose **Structural Domains**.



With the above selection, you leave out the magnet, pole piece, and top plate. You will consider these domains as perfectly rigid, by using the default sound hard wall condition on their surfaces.

Add damping to some of the solid material.

Linear Elastic Material 1

In the **Model Builder** window, under **Component 1 (comp1) > Solid Mechanics (solid)** click **Linear Elastic Material 1**.



Damping 1

- 1 In the **Physics** toolbar, click  **Attributes** and choose **Damping**.
- 2 In the **Settings** window for **Damping**, locate the **Domain Selection** section.
- 3 Click  **Clear Selection**.
- 4 From the **Selection** list, choose **Composite and Glass Fiber**.
- 5 Locate the **Damping Settings** section. From the **Damping type** list, choose **Isotropic loss factor**.

Linear Elastic Material 1

In the **Model Builder** window, click **Linear Elastic Material 1**.



Damping 2

- 1 In the **Physics** toolbar, click  **Attributes** and choose **Damping**.
- 2 In the **Settings** window for **Damping**, locate the **Domain Selection** section.
- 3 Click  **Clear Selection**.
- 4 From the **Selection** list, choose **Cloth**.
- 5 Locate the **Damping Settings** section. In the β_{dK} text field, type $0.14/\omega_{loss}$.

Linear Elastic Material 1

In the **Model Builder** window, click **Linear Elastic Material 1**.

Damping 3

- 1 In the **Physics** toolbar, click  **Attributes** and choose **Damping**.
- 2 In the **Settings** window for **Damping**, locate the **Domain Selection** section.
- 3 Click  **Clear Selection**.
- 4 From the **Selection** list, choose **Foam**.
- 5 Locate the **Damping Settings** section. In the β_{dK} text field, type $0.46/\omega_{loss}$.
The spider and the surround are attached to the case.

Fixed Constraint 1

- 1 In the **Physics** toolbar, click  **Boundaries** and choose **Fixed Constraint**.
- 2 Select Boundaries 81 and 85 only.

Now is a good time to inspect **Acoustic-Structure Boundary 1** multiphysics coupling under the **Multiphysics** node. When using a predefined multiphysics interface the coupling is automatically applied to all acoustic-solid boundaries.

Now, the **Magnetomechanics** multiphysics feature is added to handle Lorentz force on the coil (it represents the product of the time-harmonic current and the static magnetic field in which it is traveling). For details, see [Notes About the COMSOL Implementation](#).

MULTIPHYSICS

Magnetomechanics 1 (mmcp11)

- 1 In the **Physics** toolbar, click  **Multiphysics Couplings** and choose **Domain > Magnetomechanics**.
- 2 In the **Settings** window for **Magnetomechanics**, locate the **Lorentz Coupling** section.
- 3 Select the **Only use Lorentz force** checkbox.
- 4 Locate the **Domain Selection** section. From the **Selection** list, choose **Coil**.

MESH 1

In this model, the mesh is set up manually. Proceed by directly adding the desired mesh component.

The mesh used in computing the impedance needs to resolve the induced eddy currents in the pole piece and the top plate. For the results to be accurate, the skin depth needs to be resolved by at least 1, preferably 2 quadratic elements.

With a conductivity of $1.12e7$ S/m and a peak relative permeability of 1200, the skin depth in the iron at the maximum frequency of 8 kHz does not go below 0.05 mm. In practice, most of the induced currents will run in regions of the pole piece where the biased relative permeability is much less than 1200, which makes the skin depth greater. In this model, it is therefore sufficient to use a mesh size of 0.5 mm along the iron surfaces that are closest to the voice coil.

For the acoustic-structure interaction, the air domain and the thin moving structures also need to be well resolved. In general, 5 to 6 second-order elements per wavelength are needed to resolve the waves. For more details, see *Meshing (Resolving the Waves)* in the *Acoustics Module User's Guide*. In this model, use 5 elements per wavelength in the acoustic domains. The PML is preferably meshed with mapped elements, use 8 elements for the default polynomial scaling.

Mapped 1

- 1 In the **Mesh** toolbar, click  **Mapped**.

- 2 In the **Settings** window for **Mapped**, locate the **Domain Selection** section.
- 3 From the **Geometric entity level** list, choose **Domain**.
- 4 Select Domains 1, 3, 5, 8–22, and 25 only.

Size

- 1 In the **Model Builder** window, click **Size**.
- 2 In the **Settings** window for **Size**, locate the **Element Size** section.
- 3 Click the **Custom** button.
- 4 Locate the **Element Size Parameters** section. In the **Maximum element size** text field, type 1mm/5.
- 5 In the **Minimum element size** text field, type 0.5[mm].
- 6 In the **Maximum element growth rate** text field, type 1.15.

Size 1

- 1 In the **Model Builder** window, right-click **Mapped 1** and choose **Size**.
- 2 Select Domains 9, 13–16, and 20 only.
- 3 In the **Settings** window for **Size**, locate the **Element Size** section.
- 4 Click the **Custom** button.
- 5 Locate the **Element Size Parameters** section.
- 6 Select the **Maximum element size** checkbox. In the associated text field, type 2[mm].

Size 2

- 1 Right-click **Mapped 1** and choose **Size**.
- 2 In the **Settings** window for **Size**, locate the **Geometric Entity Selection** section.
- 3 Click  **Clear Selection**.
- 4 Select Domains 3, 21, and 25 only.
- 5 Locate the **Element Size** section. Click the **Custom** button.
- 6 Locate the **Element Size Parameters** section.
- 7 Select the **Maximum element size** checkbox. In the associated text field, type 4[mm].

Size 3

- 1 Right-click **Mapped 1** and choose **Size**.
- 2 In the **Settings** window for **Size**, locate the **Geometric Entity Selection** section.
- 3 Click  **Clear Selection**.
- 4 Select Domains 8, 10–12, 17–19, and 22 only.

- 5 Locate the **Element Size** section. Click the **Custom** button.
- 6 Locate the **Element Size Parameters** section.
- 7 Select the **Maximum element size** checkbox. In the associated text field, type 0.5[mm].

Distribution 1

- 1 Right-click **Mapped 1** and choose **Distribution**.
- 2 Select Boundaries 22, 38, 41, and 45 only.
- 3 In the **Settings** window for **Distribution**, locate the **Distribution** section.
- 4 In the **Number of elements** text field, type 2.

Distribution 2

- 1 Right-click **Mapped 1** and choose **Distribution**.
- 2 Select Boundaries 87 and 88 only.
- 3 In the **Settings** window for **Distribution**, locate the **Distribution** section.
- 4 In the **Number of elements** text field, type 8.
- 5 Click  **Build Selected**.

Free Triangular 1

In the **Mesh** toolbar, click  **Free Triangular**.

Boundary Layers 1

- 1 In the **Mesh** toolbar, click  **Boundary Layers**.
- 2 In the **Settings** window for **Boundary Layers**, locate the **Domain Selection** section.
- 3 From the **Geometric entity level** list, choose **Domain**.
- 4 Select Domains 4, 6, and 23 only.
- 5 Click to expand the **Transition** section. Clear the **Smooth transition to interior mesh** checkbox.

Boundary Layer Properties

- 1 In the **Model Builder** window, click **Boundary Layer Properties**.
- 2 Select Boundaries 12, 53, and 95–98 only.

Boundary Layer Properties 1

- 1 In the **Mesh** toolbar, click  **More Attributes** and choose **Boundary Layer Properties**.
- 2 Select Boundary 93 only.
- 3 In the **Settings** window for **Boundary Layer Properties**, locate the **Layers** section.
- 4 In the **Number of layers** text field, type 1.

- 5 Click  **Build All**.

The image should look like this.

- 6 In the **Model Builder** window, click **Mesh 1**.

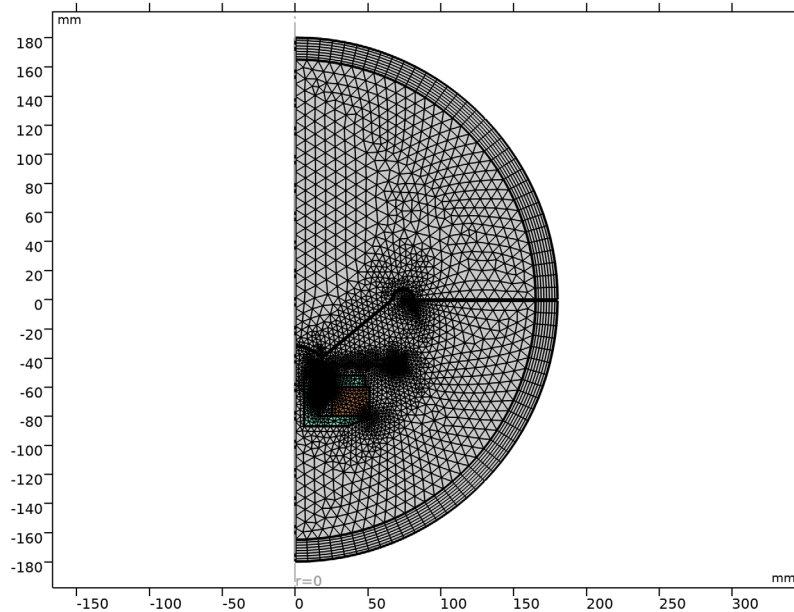

STUDY 1 - MAGNETIC FIELDS

- 1 In the **Model Builder** window, click **Study 1**.
- 2 In the **Settings** window for **Study**, type Study 1 - Magnetic Fields in the **Label** text field.



Your Study node already contains the Stationary study that you picked from the Model Wizard. Disable the Pressure Acoustics and Solid Mechanics interfaces.

Add a Frequency-Domain, Perturbation study.
- 3 Locate the **Study Settings** section. Clear the **Generate default plots** checkbox.

Step 1: Stationary

- 1 In the **Model Builder** window, under **Study 1 - Magnetic Fields** click **Step 1: Stationary**.
- 2 In the **Settings** window for **Stationary**, locate the **Physics and Variables Selection** section.
- 3 In the **Solve for** column of the table, under **Component 1 (comp1)**, clear the checkbox for **Solid Mechanics (solid)**.

Step 2: Frequency-Domain Perturbation

- 1 In the **Study** toolbar, click  **Study Steps** and choose **Frequency Domain > Frequency-Domain Perturbation**.
- 2 In the **Settings** window for **Frequency-Domain Perturbation**, locate the **Study Settings** section.
- 3 In the **Frequencies** text field, type 1 2 3 4 5 6 7 8 9.
- 4 Click  **Range**.
- 5 In the **Range** dialog, choose **ISO preferred frequencies** from the **Entry method** list.
- 6 In the **Start frequency** text field, type 10.
- 7 In the **Stop frequency** text field, type fmax.
- 8 From the **Interval** list, choose **1/12 octave**.
- 9 Click **Add**.

This generates a few frequency points below 10 Hz and ISO preferred frequencies between 10 Hz and 8 kHz.

- 10 In the **Settings** window for **Frequency-Domain Perturbation**, locate the **Physics and Variables Selection** section.
- 11 In the **Solve for** column of the table, under **Component 1 (comp1)**, clear the checkboxes for **Pressure Acoustics, Frequency Domain (acpr)** and **Solid Mechanics (solid)**.

NOTE: The first solution of this model is only of the electromagnetic part of the problem, with the coil assumed to be fixed in order to extract the BL factor and the blocked coil impedance. If you would like to skip ahead to the solution of the full electroacoustic problem, you can do so by proceeding from here to the instructions starting at the section **Component 1 (comp1)**, further below. Otherwise, continue by computing the solution.

- 12 In the **Study** toolbar, click  **Compute**.

RESULTS

First, create a 2D plot to view the magnetic field distribution from the permanent magnet.

Static Magnetic Field

- 1 In the **Results** toolbar, click  **2D Plot Group**.
- 2 In the **Settings** window for **2D Plot Group**, type **Static Magnetic Field** in the **Label** text field.
- 3 Locate the **Color Legend** section. Select the **Show units** checkbox.

- 4 Locate the **Data** section. From the **Dataset** list, choose **Study 1 - Magnetic Fields/ Solution Store 1 (sol2)**.

Each step in a study creates its own dataset. The numbering of the datasets begins from the last step. Hence in this model Solution 2 contains the stationary solution and Solution 1 the frequency domain perturbation.

Surface 1

- 1 Right-click **Static Magnetic Field** and choose **Surface**.
- 2 In the **Settings** window for **Surface**, click **Replace Expression** in the upper-right corner of the **Expression** section. From the menu, choose **Component 1 (comp1) > Magnetic Fields > Magnetic > mf.normH - Magnetic field norm - A/m**.
- 3 Locate the **Coloring and Style** section. From the **Color table** list, choose **Thermal**.
- 4 In the **Static Magnetic Field** toolbar, click  **Plot**.

You are now looking at the magnetic field norm created by the permanent magnet. Note that it has a distinct maximum in the gap where the voice coil is moving. If you zoom in a little, the plot should look like [Figure 3](#).

Another interesting result is the effective relative permeability distribution in the iron. Begin by duplicating the existing plot.

Effective Relative Permeability

- 1 In the **Model Builder** window, right-click **Static Magnetic Field** and choose **Duplicate**.
- 2 In the **Settings** window for **2D Plot Group**, type Effective Relative Permeability in the **Label** text field.

Surface 1

- 1 In the **Model Builder** window, expand the **Effective Relative Permeability** node, then click **Surface 1**.
- 2 In the **Settings** window for **Surface**, locate the **Expression** section.
- 3 In the **Expression** text field, type $mf.normB / (\mu_0_{const} * mf.normH)$.
- 4 Select the **Description** checkbox. In the associated text field, type Effective relative permeability.
- 5 In the **Effective Relative Permeability** toolbar, click  **Plot**.

This is the effective relative permeability at the linearization point, as given by the ratio of the flux density and the field multiplied by the permeability of vacuum. The plot should look like [Figure 4](#).

Next, evaluate the BL force factor.

Surface Average I

- 1 In the **Results** toolbar, click 8.85×10^{-12} **More Derived Values** and choose **Average** > **Surface Average**.
- 2 In the **Settings** window for **Surface Average**, locate the **Data** section.
- 3 From the **Dataset** list, choose **Study I - Magnetic Fields/Solution Store I (sol2)**.
- 4 Locate the **Selection** section. From the **Selection** list, choose **Coil**.
- 5 Locate the **Expressions** section. In the table, enter the following settings:

Expression	Unit	Description
$-mf.Br*N0*2*pi*r$	N/A	BL

- 6 Locate the **Integration Settings** section. Clear the **Compute volume integral** checkbox.
- 7 Click  **Evaluate**.

The BL factor evaluates to 10.5 N/A.

Next, study the induced current density at a few different frequencies.

Induced Current Density

- 1 In the **Results** toolbar, click  **2D Plot Group**.
- 2 In the **Settings** window for **2D Plot Group**, type Induced Current Density in the **Label** text field.
- 3 Locate the **Color Legend** section. Select the **Show units** checkbox.

Surface I

- 1 Right-click **Induced Current Density** and choose **Surface**.
- 2 In the **Settings** window for **Surface**, click **Replace Expression** in the upper-right corner of the **Expression** section. From the menu, choose **Component I (comp1)** > **Magnetic Fields** > **Currents and charge** > **Conduction current density (spatial frame) - A/m²** > **mf.jphi - Conduction current density, phi-component**.

Note that the **Compute differential** checkbox, if turned on, wraps the expression in a `lindev()` operator. For more information, search for `lindev` in the COMSOL Multiphysics Documentation. The use of this checkbox is only necessary when plotting expressions that are not linear in the fields and that contain components of the linearization point (the DC solution). Examples of this type of expressions include electromagnetic force expressions.

- 3 Locate the **Coloring and Style** section. From the **Color table** list, choose **Prism**.
- 4 From the **Color table transformation** list, choose **Reverse**.

- 5 In the **Induced Current Density** toolbar, click  **Plot**.

At 3500 Hz, the induced currents (or conduction currents) are highly localized to the surfaces of the top plate and pole piece.

Induced Current Density

- 1 In the **Model Builder** window, click **Induced Current Density**.
- 2 In the **Settings** window for **2D Plot Group**, locate the **Data** section.
- 3 From the **Parameter value (freq (Hz))** list, choose **I**.
- 4 In the **Induced Current Density** toolbar, click  **Plot**.

At 10 Hz, the induced currents distribute throughout the material. The distribution depends on the vicinity to the voice coil, but also very much on the local effective permeability from the static study. To reproduce [Figure 5](#), try two frequencies in between.

Before proceeding to the full electroacoustic analysis, plot the blocked coil inductance as a function of the frequency.



Blocked Coil Inductance

- 1 In the **Results** toolbar, click  **ID Plot Group**.
- 2 In the **Settings** window for **ID Plot Group**, type Blocked Coil Inductance in the **Label** text field.
- 3 Click to expand the **Title** section. From the **Title type** list, choose **Label**.

Global I

- 1 Right-click **Blocked Coil Inductance** and choose **Global**.
- 2 In the **Settings** window for **Global**, locate the **y-Axis Data** section.
- 3 In the table, enter the following settings:

Expression	Unit	Description
mf.LCoil_1	mH	Coil inductance

- 4 Click the  **x-Axis Log Scale** button in the **Graphics** toolbar.
- 5 In the **Blocked Coil Inductance** toolbar, click  **Plot**.

The result should look like [Figure 6](#).

Having extracted the force factor and the voice coil inductance, you now have most of the electromagnetic data required for a separate model of the acoustic parts of a boxed loudspeaker driver. See the **Loudspeaker Driver** in a **Vented Enclosure** model also in the Application Library. What remains is the real part of the blocked coil

impedance. This is available as `mf.RCoil_1`, the Coil Resistance. If you would like to extract this too, you can set it up in a Global plot just like the inductance, and export the results as described in the following steps.

Plot 1

- 1 Right-click **Global 1** and choose **Add Plot Data to Export**.

If you want to export the data, you can now enter a filename and click the **Export** button.

COMPONENT 1 (COMP1)

It is now time to compute and evaluate the solution of the entire model, including the acoustic-structure interaction. In order to this, you will set up a new study. Although you could technically reuse the static magnetic fields solution from the first study, it can be handy to include this step in the new study too. This allows you to make changes anywhere in the model, including such that affect the static magnetic fields, and run only the new study again to get correctly updated results.

ADD STUDY

- 1 In the **Home** toolbar, click  **Add Study** to open the **Add Study** window.

- 2 Go to the **Add Study** window.

Select an empty study so that you can copy and modify the study steps from your previous study.

- 3 Find the **Studies** subsection. In the **Select Study** tree, select **Empty Study**.

- 4 Click the **Add Study** button in the window toolbar.

- 5 In the **Home** toolbar, click  **Add Study** to close the **Add Study** window.

STUDY 1 - MAGNETIC FIELDS

Step 1: Stationary, Step 2: Frequency-Domain Perturbation

- 1 In the **Model Builder** window, under **Study 1 - Magnetic Fields**, Ctrl-click to select **Step 1: Stationary** and **Step 2: Frequency-Domain Perturbation**.

- 2 Right-click and choose **Copy**.

STUDY 2 - COMPLETE MODEL

- 1 In the **Model Builder** window, right-click **Study 2** and choose **Paste Multiple Items**.

- 2 In the **Settings** window for **Study**, type Study 2 - Complete Model in the **Label** text field.

- 3 Locate the **Study Settings** section. Clear the **Generate default plots** checkbox.

Step 2: Frequency-Domain Perturbation

Make the Frequency Domain, Perturbed study solve for the acoustics and the solid physics too.

- 1 In the **Model Builder** window, under **Study 2 - Complete Model** click **Step 2: Frequency-Domain Perturbation**.
- 2 In the **Settings** window for **Frequency-Domain Perturbation**, locate the **Physics and Variables Selection** section.
- 3 In the **Solve for** column of the table, under **Component 1 (comp1)**, select the checkboxes for **Pressure Acoustics, Frequency Domain (acpr)** and **Solid Mechanics (solid)**.
- 4 In the **Study** toolbar, click  **Compute**.

RESULTS

You will now have received two more datasets: Solution 4 containing the same static magnetic fields as Solution 2, and Solution 3 with the frequency domain electromagnetic and acoustic-structure interaction results. In order to get a good overview of the latter, begin by adding a selection of all domains except the PMLs.

Study 2 - Complete Model/Solution 3 (sol3)



In the **Model Builder** window, expand the **Results > Datasets** node, then click **Study 2 - Complete Model/Solution 3 (sol3)**.

Selection

- 1 In the **Results** toolbar, click  **Attributes** and choose **Selection**.
- 2 In the **Settings** window for **Selection**, locate the **Geometric Entity Selection** section.
- 3 From the **Geometric entity level** list, choose **Domain**.
- 4 From the **Selection** list, choose **All Domains Without the PML**.

Create a 3D plot of the instantaneous pressure distribution at zero phase in and around the speaker.

RESULT TEMPLATES

- 1 In the **Results** toolbar, click  **Result Templates** to open the **Result Templates** window.
- 2 Go to the **Result Templates** window.
- 3 In the tree, select **Study 2 - Complete Model/Solution 3 (sol3) > Pressure Acoustics, Frequency Domain > Acoustic Pressure, 3D (acpr)**.
- 4 Click the **Add Result Template** button in the window toolbar.
- 5 In the **Results** toolbar, click  **Result Templates** to close the **Result Templates** window.



RESULTS

Contour 1

- 1 In the **Model Builder** window, right-click **Acoustic Pressure, 3D (acpr)** and choose **Contour**.
- 2 In the **Settings** window for **Contour**, locate the **Expression** section.
- 3 In the **Expression** text field, type `acpr.p_t`.
- 4 Locate the **Coloring and Style** section. From the **Coloring** list, choose **Uniform**.
- 5 From the **Color** list, choose **Gray**.
- 6 Clear the **Color legend** checkbox.



Next, reproduce [Figure 7](#) with a plot of the local sound pressure level.

RESULT TEMPLATES

- 1 In the **Results** toolbar, click  **Result Templates** to open the **Result Templates** window.
- 2 Go to the **Result Templates** window.
- 3 In the tree, select **Study 2 - Complete Model/Solution 3 (sol3) > Pressure Acoustics, Frequency Domain > Sound Pressure Level, 3D (acpr)**.
- 4 Click the **Add Result Template** button in the window toolbar.
- 5 In the **Results** toolbar, click  **Result Templates** to close the **Result Templates** window.

RESULTS

Sound Pressure Level, 3D (acpr)

- 1 Click the  **Show Grid** button in the **Graphics** toolbar.
- 2 In the **Sound Pressure Level, 3D (acpr)** toolbar, click  **Plot**.

The result should look like [Figure 7](#).

Create a 1D plot of the sensitivity versus the frequency, as in [Figure 8](#).

Sensitivity

- 1 In the **Results** toolbar, click  **ID Plot Group**.
- 2 In the **Settings** window for **ID Plot Group**, type **Sensitivity** in the **Label** text field.
- 3 Locate the **Data** section. From the **Dataset** list, choose **Study 2 - Complete Model/Solution 3 (sol3)**.
- 4 Locate the **Title** section. From the **Title type** list, choose **Label**.
- 5 Locate the **Plot Settings** section.
- 6 Select the **x-axis label** checkbox. In the associated text field, type **Frequency (Hz)**.

- 7 Select the **y-axis label** checkbox. In the associated text field, type **SPL (dB)**.
- 8 Locate the **Legend** section. From the **Position** list, choose **Lower middle**.

Octave Band 1

- 1 In the **Sensitivity** toolbar, click  **More Plots** and choose **Octave Band**.
- 2 In the **Settings** window for **Octave Band**, locate the **Selection** section.
- 3 From the **Geometric entity level** list, choose **Global**.

Use the Octave Band Plot to depict the sensitivity. Evaluate the pressure 1 m in front using `pext()` operator. The reference pressure is the default for an SPL evaluation. Plot the sensitivity both as a continuous curve and in 1/3 octave bands.

- 4 Locate the **y-Axis Data** section. In the **Expression** text field, type `pext(0,1[m])`.
- 5 In the **Sensitivity** toolbar, click  **Plot**.
- 6 Locate the **Plot** section. From the **Quantity** list, choose **Band average power spectral density**.
- 7 From the **Band type** list, choose **1/3 octave**.
- 8 Click to expand the **Coloring and Style** section. From the **Type** list, choose **Outline**.

Octave Band 2

- 1 Right-click **Octave Band 1** and choose **Duplicate**.
- 2 In the **Settings** window for **Octave Band**, locate the **Plot** section.
- 3 From the **Quantity** list, choose **Continuous power spectral density**.
- 4 In the **Sensitivity** toolbar, click  **Plot**.
- 5 Locate the **Coloring and Style** section. From the **Width** list, choose **2**.
- 6 Click to expand the **Legends** section. Select the **Show legends** checkbox.
- 7 From the **Legends** list, choose **Manual**.
- 8 In the table, enter the following settings:

Legends

Complete Study

Sensitivity

- 1 In the **Model Builder** window, click **Sensitivity**.
- 2 In the **Settings** window for **ID Plot Group**, locate the **Axis** section.
- 3 Select the **Manual axis limits** checkbox.
- 4 In the **x minimum** text field, type **15**.

- 5 In the **y minimum** text field, type 64.
- 6 In the **y maximum** text field, type 92.
- 7 Locate the **Legend** section. From the **Position** list, choose **Lower right**.
- 8 In the **Sensitivity** toolbar, click  **Plot**.
Finally, plot the total electric impedance versus the frequency.



Total Electric Impedance

- 1 In the **Results** toolbar, click  **ID Plot Group**.
- 2 In the **Settings** window for **ID Plot Group**, type Total Electric Impedance in the **Label** text field.
- 3 Locate the **Data** section. From the **Dataset** list, choose **Study 2 - Complete Model/ Solution 3 (sol3)**.
- 4 Locate the **Title** section. From the **Title type** list, choose **Label**.
- 5 Locate the **Plot Settings** section.
- 6 Select the **x-axis label** checkbox. In the associated text field, type Frequency (Hz).
- 7 Select the **y-axis label** checkbox. In the associated text field, type $Z (\omega)$.

Global I

- 1 Right-click **Total Electric Impedance** and choose **Global**.
A predefined variable exists of the coil impedance `mf.ZCoil_1`. It is defined as the driving voltage divided by the time-harmonic current through the coil. The results are depicted in [Figure 10](#).
- 2 In the **Settings** window for **Global**, locate the **y-Axis Data** section.
- 3 In the table, enter the following settings:

Expression	Unit	Description
<code>abs(mf.ZCoil_1)</code>		<code>abs(Z)</code>
<code>real(mf.ZCoil_1)</code>		<code>real(Z)</code>
<code>imag(mf.ZCoil_1)</code>		<code>imag(Z)</code>

- 4 In the **Total Electric Impedance** toolbar, click  **Plot**.
- 5 Click the  **x-Axis Log Scale** button in the **Graphics** toolbar.
Next create a plot of the deformation of the loudspeaker showing the displacement. This can in general be used to visualize breakups in the cone and surround.

Displacement

- 1 In the **Results** toolbar, click  **3D Plot Group**.

- 2 In the **Settings** window for **3D Plot Group**, type Displacement in the **Label** text field.
- 3 Locate the **Color Legend** section. Select the **Show units** checkbox.

Surface 1

- 1 Right-click **Displacement** and choose **Surface**.
- 2 In the **Settings** window for **Surface**, locate the **Expression** section.
- 3 In the **Expression** text field, type `solid.disp`.

Deformation 1

- 1 Right-click **Surface 1** and choose **Deformation**.
- 2 In the **Displacement** toolbar, click  **Plot**.

The plot should look like the one in [Figure 10](#).

Now, visualize the directivity of the loudspeaker using the built-in **Directivity** plot. This is an important plot used to visualize and analyze the spatial response of the speaker as function of the frequency.

Directivity Plot

- 1 In the **Results** toolbar, click  **ID Plot Group**.
- 2 In the **Settings** window for **ID Plot Group**, type Directivity Plot in the **Label** text field.
- 3 Locate the **Data** section. From the **Dataset** list, choose **Study 2 - Complete Model/ Solution 3 (sol3)**.
- 4 Locate the **Title** section. From the **Title type** list, choose **Label**.

Directivity 1

- 1 In the **Directivity Plot** toolbar, click  **More Plots** and choose **Directivity**.
Per default the reference direction is along the z -axis. This defines what 0 deg corresponds to. Change the angles to correspond to everything in front of the speaker, that is, from -90 to 90 deg.
- 2 In the **Settings** window for **Directivity**, locate the **Evaluation** section.
- 3 Find the **Angles** subsection. From the **Restriction** list, choose **Manual**.
- 4 In the **Number of angles** text field, type 360.
- 5 In the ϕ **start** text field, type -90.
- 6 In the ϕ **range** text field, type 180.
- 7 Find the **Evaluation distance** subsection. In the **Radius** text field, type 1[m].
- 8 Locate the **Levels** section. From the **Entry method** list, choose **Levels**.

9 In the **Levels** text field, type -15 -12 -9 -6 -3 -2 -1 1 2 3.

10 In the **Directivity Plot** toolbar, click  **Plot**.

The horizontal scale can also be represented using a logarithmic scale by selecting **x-Axis Log Scale** in the **Graphics** window.

The image should look like the one in [Figure 12](#). If you are more familiar with having the frequency on the *y*-axis, you can just change that under the **Coloring and Style** tab and change the **Layout** option.

Coil Power and Efficiency

1 In the **Results** toolbar, click  **ID Plot Group**.

2 In the **Settings** window for **ID Plot Group**, type **Coil Power and Efficiency** in the **Label** text field.

3 Locate the **Title** section. From the **Title type** list, choose **Label**.

4 Locate the **Data** section. From the **Dataset** list, choose **Study 2 - Complete Model/ Solution 3 (sol3)**.

5 Locate the **Plot Settings** section. Select the **Two y-axes** checkbox.

6 Locate the **Legend** section. From the **Position** list, choose **Middle left**.

Global 1

1 Right-click **Coil Power and Efficiency** and choose **Global**.

2 In the **Settings** window for **Global**, locate the **y-Axis Data** section.

3 In the table, enter the following settings:

Expression	Unit	Description
coil_power	W	Coil power

Global 2

1 In the **Model Builder** window, right-click **Coil Power and Efficiency** and choose **Global**.

2 In the **Settings** window for **Global**, locate the **y-Axis** section.

3 Select the **Plot on secondary y-axis** checkbox.

4 Locate the **y-Axis Data** section. In the table, enter the following settings:

Expression	Unit	Description
aco_eff	%	Acoustic efficiency

5 Click the  **x-Axis Log Scale** button in the **Graphics** toolbar.

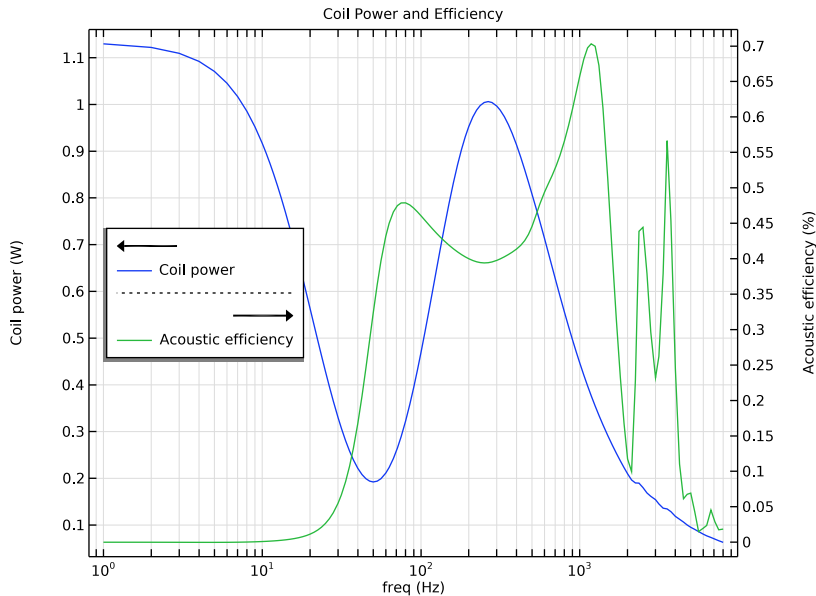

6 In the **Coil Power and Efficiency** toolbar, click  **Plot**.

The plot should look like this.



In the following steps, create a new study where the **Narrow Region Acoustics** features are disabled. This will highlight how the thermoviscous losses have a large influence around the back cavity modes but negligible influence on the global response of the loudspeaker for the rest of the frequencies.

ADD STUDY

- 1 In the **Home** toolbar, click  **Add Study** to open the **Add Study** window.
- 2 Go to the **Add Study** window.
- 3 Find the **Studies** subsection. In the **Select Study** tree, select **Empty Study**.
- 4 Click the **Add Study** button in the window toolbar.
- 5 In the **Home** toolbar, click  **Add Study** to close the **Add Study** window.

STUDY 2 - COMPLETE MODEL

Step 1: Stationary

In the **Model Builder** window, under **Study 2 - Complete Model** right-click **Step 1: Stationary** and choose **Copy**.

STUDY 3

In the **Model Builder** window, right-click **Study 3** and choose **Paste Stationary**.



STUDY 2 - COMPLETE MODEL

Step 2: Frequency-Domain Perturbation

In the **Model Builder** window, under **Study 2 - Complete Model** right-click **Step 2: Frequency-Domain Perturbation** and choose **Copy**.

STUDY 3 - COMPLETE MODEL, WITHOUT NARROW REGION ACOUSTICS

In the **Model Builder** window, right-click **Study 3** and choose **Paste Frequency-Domain Perturbation**.

- 1 In the **Settings** window for **Frequency-Domain Perturbation**, locate the **Physics and Variables Selection** section.
- 2 Select the **Modify model configuration for study step** checkbox.
- 3 In the tree, select **Component 1 (comp1) > Pressure Acoustics, Frequency Domain (acpr) > Narrow Region Acoustics 1**.
- 4 Click  **Disable**.
- 5 In the tree, select **Component 1 (comp1) > Pressure Acoustics, Frequency Domain (acpr) > Narrow Region Acoustics 2**.
- 6 Click  **Disable**.
- 7 In the **Model Builder** window, click **Study 3**.
- 8 In the **Settings** window for **Study**, type Study 3 - Complete Model, Without Narrow Region Acoustics in the **Label** text field.
- 9 Locate the **Study Settings** section. Clear the **Generate default plots** checkbox.
- 10 In the **Study** toolbar, click  **Compute**.

RESULTS

Octave Band 2

- 1 In the **Model Builder** window, under **Results > Sensitivity** click **Octave Band 2**.
- 2 In the **Settings** window for **Octave Band**, locate the **Data** section.
- 3 From the **Dataset** list, choose **Study 3 - Complete Model, Without Narrow Region Acoustics/Solution 5 (sol5)**.

4 Locate the **Legends** section. In the table, enter the following settings:

Legends

Complete Study - Without Narrow Region Acoustics

5 Locate the **Coloring and Style** section. Find the **Line style** subsection. From the **Line** list, choose **Dotted**.

Octave Band 3

1 Right-click **Results > Sensitivity > Octave Band 2** and choose **Duplicate**.

2 In the **Settings** window for **Octave Band**, locate the **Data** section.

3 From the **Dataset** list, choose **From parent**.

4 Locate the **Legends** section. In the table, enter the following settings:

Legends

Complete Study

5 Locate the **Coloring and Style** section. Find the **Line style** subsection. From the **Line** list, choose **Solid**.

6 In the **Sensitivity** toolbar, click  **Plot**.

The image should look like the one in [Figure 8](#). As you can see, the two models only differ for the frequencies around 600 Hz and 1300 Hz, which indicate back cavity modes.

Proceed and create a mirror dataset. It will be used to visually compare the frequency distribution in the driver at different frequencies, by having them side by side.

Mirror 2D 1

1 In the **Results** toolbar, click  **More Datasets** and choose **Mirror 2D**.

2 In the **Settings** window for **Mirror 2D**, locate the **Data** section.

3 From the **Dataset** list, choose **Study 3 - Complete Model, Without Narrow Region Acoustics/Solution 5 (sol5)**.

Acoustic Pressure - Without Narrow Region Acoustics

1 In the **Results** toolbar, click  **2D Plot Group**.

2 In the **Settings** window for **2D Plot Group**, type **Acoustic Pressure - Without Narrow Region Acoustics** in the **Label** text field.

3 Locate the **Color Legend** section. Select the **Show units** checkbox.

4 Locate the **Data** section. From the **Dataset** list, choose **Mirror 2D 1**.

- 5 From the **Parameter value (freq (Hz))** list, choose **600**.

Surface 1

- 1 Right-click **Acoustic Pressure - Without Narrow Region Acoustics** and choose **Surface**.
- 2 In the **Settings** window for **Surface**, locate the **Expression** section.
- 3 In the **Expression** text field, type `acpr.p_t`.
- 4 Locate the **Coloring and Style** section. From the **Scale** list, choose **Linear symmetric**.
- 5 From the **Color table** list, choose **Wave**.
- 6 In the **Acoustic Pressure - Without Narrow Region Acoustics** toolbar, click  **Plot**.

Surface 2

- 1 Right-click **Surface 1** and choose **Duplicate**.
- 2 In the **Settings** window for **Surface**, locate the **Data** section.
- 3 From the **Dataset** list, choose **Study 3 - Complete Model, Without Narrow Region Acoustics/Solution 5 (sol5)**.
- 4 From the **Parameter value (freq (Hz))** list, choose **630**.
- 5 Click to expand the **Title** section. From the **Title type** list, choose **None**.
- 6 Click to expand the **Inherit Style** section. From the **Plot** list, choose **Surface 1**.



Annotation 1

- 1 In the **Model Builder** window, right-click **Acoustic Pressure - Without Narrow Region Acoustics** and choose **Annotation**.
- 2 In the **Settings** window for **Annotation**, locate the **Annotation** section.
- 3 In the **Text** text field, type `Pressure at 630 Hz`.
- 4 Locate the **Position** section. In the **x** text field, type `10[mm]`.
- 5 In the **y** text field, type `20[mm]`.
- 6 Locate the **Coloring and Style** section. Clear the **Show point** checkbox.

Annotation 2

- 1 Right-click **Annotation 1** and choose **Duplicate**.
- 2 In the **Settings** window for **Annotation**, locate the **Position** section.
- 3 In the **x** text field, type `-140[mm]`.
- 4 Locate the **Annotation** section. In the **Text** text field, type `Pressure at 600 Hz`.



Line 1

- 1 In the **Model Builder** window, right-click **Acoustic Pressure - Without Narrow Region Acoustics** and choose **Line**.
- 2 In the **Settings** window for **Line**, locate the **Expression** section.
- 3 In the **Expression** text field, type 0.
- 4 Locate the **Data** section. From the **Dataset** list, choose **Mirror 2D 1**.
- 5 Click to expand the **Title** section. From the **Title type** list, choose **None**.
- 6 Locate the **Coloring and Style** section. From the **Coloring** list, choose **Uniform**.
- 7 From the **Color** list, choose **Black**.
- 8 Click the  **Zoom Extents** button in the **Graphics** toolbar.
- 9 In the **Acoustic Pressure - Without Narrow Region Acoustics** toolbar, click  **Plot**.

The result should look like [Figure 9](#).

ADD STUDY

Now, proceed to set up an eigenfrequency analysis for the structural part of the loudspeaker driver.

- 1 In the **Home** toolbar, click  **Add Study** to open the **Add Study** window.
- 2 Go to the **Add Study** window.
- 3 Find the **Physics interfaces in study** subsection. In the table, clear the **Solve** checkboxes for **Magnetic Fields (mf)** and **Pressure Acoustics, Frequency Domain (acpr)**.
- 4 Find the **Multiphysics couplings in study** subsection. In the table, clear the **Solve** checkboxes for **Acoustic–Structure Boundary I (asb1)** and **Magnetomechanics I (mmcp11)**.
- 5 Find the **Studies** subsection. In the **Select Study** tree, select **General Studies > Eigenfrequency**.
- 6 Click the **Add Study** button in the window toolbar.
- 7 In the **Home** toolbar, click  **Add Study** to close the **Add Study** window.

STUDY 4 - EIGENFREQUENCY

In the **Settings** window for **Study**, type Study 4 - Eigenfrequency in the **Label** text field.

Step 1: Eigenfrequency

- 1 In the **Model Builder** window, under **Study 4 - Eigenfrequency** click **Step 1: Eigenfrequency**.
- 2 In the **Settings** window for **Eigenfrequency**, locate the **Study Settings** section.

- 3 Select the **Desired number of eigenfrequencies** checkbox. In the associated text field, type 10.
- 4 From the **Search method around shift** list, choose **Larger real part**.
- 5 In the **Study** toolbar, click  **Compute**.

RESULTS

Study 4 - Eigenfrequency/Solution 7 (sol7)

In the **Model Builder** window, under **Results** > **Datasets** click **Study 4 - Eigenfrequency/Solution 7 (sol7)**.

Selection

- 1 In the **Results** toolbar, click  **Attributes** and choose **Selection**.
- 2 In the **Settings** window for **Selection**, locate the **Geometric Entity Selection** section.
- 3 From the **Geometric entity level** list, choose **Domain**.
- 4 From the **Selection** list, choose **Structural Domains**.

Mode Shape, 3D (solid)

By looping through the different modes, you can reproduce the plot in [Figure 11](#) and identify the modes that limit the frequency range of the speaker. Note that this analysis is limited to the axisymmetric modes.

- 1 In the **Model Builder** window, under **Results** click **Mode Shape, 3D (solid)**.

Eigenfrequency=53.237+12.696i Hz Surface: Displacement magnitude (mm)

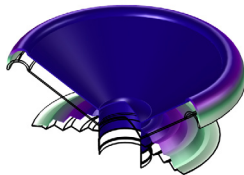

Appendix: Geometry Sequence Instructions

From the **File** menu, choose **New**.

NEW

In the **New** window, click  **Blank Model**.

ADD COMPONENT

In the **Home** toolbar, click  **Add Component** and choose **2D Axisymmetric**.

GEOMETRY 1

- 1 In the **Settings** window for **Geometry**, locate the **Units** section.
- 2 From the **Length unit** list, choose **mm**.

Circle 1 (c1)

- 1 In the **Geometry** toolbar, click  **Circle**.
- 2 In the **Settings** window for **Circle**, locate the **Size and Shape** section.
- 3 In the **Radius** text field, type 180[mm].
- 4 Click to expand the **Layers** section. In the table, enter the following settings:

Layer name	Thickness (mm)
Layer 1	15[mm]

Circle 2 (c2)

- 1 In the **Geometry** toolbar, click  **Circle**.
- 2 In the **Settings** window for **Circle**, locate the **Size and Shape** section.
- 3 In the **Radius** text field, type 8[mm].
- 4 In the **Sector angle** text field, type 180.
- 5 Locate the **Position** section. In the **r** text field, type 74[mm].
- 6 Locate the **Layers** section. In the table, enter the following settings:

Layer name	Thickness (mm)
Layer 1	1.5[mm]

Delete Entities 1 (del1)

- 1 In the **Model Builder** window, right-click **Geometry 1** and choose **Delete Entities**.
- 2 On the object **c2**, select Boundaries 2–4 only.

Rectangle 1 (r1)

- 1 In the **Geometry** toolbar, click  **Rectangle**.
- 2 In the **Settings** window for **Rectangle**, locate the **Size and Shape** section.
- 3 In the **Width** text field, type 120[mm].
- 4 In the **Height** text field, type 1[mm].
- 5 Locate the **Position** section. In the **r** text field, type 80.5[mm].

6 In the **z** text field, type -1[mm].

Difference 1 (dif1)

1 In the **Geometry** toolbar, click  **Booleans and Partitions** and choose **Difference**.

2 Select the object **c1** only.

3 In the **Settings** window for **Difference**, locate the **Difference** section.

4 Click to select the  **Activate Selection** toggle button for **Objects to subtract**.

5 Select the object **r1** only.

Rectangle 2 (r2)

1 In the **Geometry** toolbar, click  **Rectangle**.

2 In the **Settings** window for **Rectangle**, locate the **Size and Shape** section.

3 In the **Width** text field, type 42[mm].

4 In the **Height** text field, type 35[mm].

5 Locate the **Position** section. In the **r** text field, type 6[mm].

6 In the **z** text field, type -87[mm].

Rectangle 3 (r3)

1 In the **Geometry** toolbar, click  **Rectangle**.

2 In the **Settings** window for **Rectangle**, locate the **Size and Shape** section.

3 In the **Width** text field, type 35.5[mm].

4 In the **Height** text field, type 20[mm].

5 Locate the **Position** section. In the **r** text field, type 15.5[mm].

6 In the **z** text field, type -80[mm].

Rectangle 4 (r4)

1 In the **Geometry** toolbar, click  **Rectangle**.

2 In the **Settings** window for **Rectangle**, locate the **Size and Shape** section.

3 In the **Width** text field, type 1.2[mm].

4 In the **Height** text field, type 8[mm].

5 Locate the **Position** section. In the **r** text field, type 17.8[mm].

6 In the **z** text field, type -60[mm].

Rectangle 5 (r5)

1 In the **Geometry** toolbar, click  **Rectangle**.



2 In the **Settings** window for **Rectangle**, locate the **Size and Shape** section.

- 3 In the **Width** text field, type 26[mm].
- 4 In the **Height** text field, type 20[mm].
- 5 Locate the **Position** section. In the **r** text field, type 25[mm].
- 6 In the **z** text field, type -80[mm].

Polygon 1 (pol1)

- 1 In the **Geometry** toolbar, click  **Polygon**.
- 2 In the **Settings** window for **Polygon**, locate the **Coordinates** section.
- 3 From the **Data source** list, choose **Vectors**.
- 4 In the **r** text field, type 48[mm] 36[mm] 36[mm] 48[mm].
- 5 In the **z** text field, type -82[mm] -87[mm] -87[mm] -87[mm].

Difference 2 (dif2)

- 1 In the **Geometry** toolbar, click  **Booleans and Partitions** and choose **Difference**.
- 2 Select the object **r2** only.
- 3 In the **Settings** window for **Difference**, locate the **Difference** section.
- 4 Click to select the  **Activate Selection** toggle button for **Objects to subtract**.
- 5 Select the objects **pol1**, **r3**, and **r4** only.

Rectangle 6 (r6)

- 1 In the **Geometry** toolbar, click  **Rectangle**.
- 2 In the **Settings** window for **Rectangle**, locate the **Size and Shape** section.
- 3 In the **Width** text field, type 0.2[mm].
- 4 In the **Height** text field, type 25[mm].
- 5 Locate the **Position** section. In the **r** text field, type 18.2[mm].
- 6 In the **z** text field, type -64[mm].
- 7 Click to expand the **Layers** section. In the table, enter the following settings:

Layer name	Thickness (mm)
Layer 1	1.26[mm]
Layer 2	3.84[mm]
Layer 3	0.4[mm]

- 8 Clear the **Layers on bottom** checkbox.
- 9 Select the **Layers on top** checkbox.

Rectangle 7 (r7)

- 1 In the **Geometry** toolbar, click  **Rectangle**.
- 2 In the **Settings** window for **Rectangle**, locate the **Size and Shape** section.
- 3 In the **Width** text field, type 0.6[mm].
- 4 In the **Height** text field, type 9.4[mm].
- 5 Locate the **Position** section. In the **r** text field, type 18.2[mm].
- 6 In the **z** text field, type -60.7[mm].

Polygon 2 (pol2)

- 1 In the **Geometry** toolbar, click  **Polygon**.
- 2 In the **Settings** window for **Polygon**, locate the **Coordinates** section.
- 3 From the **Data source** list, choose **Vectors**.
- 4 In the **r** text field, type 18.4[mm] 23[mm] 26[mm] 26[mm] 32[mm] 32[mm] 38[mm] 38[mm] 44[mm] 44[mm] 50[mm] 50[mm] 56[mm] 56[mm] 59[mm] 66[mm] 66[mm] 59[mm] 56[mm] 56[mm] 50[mm] 50[mm] 44[mm] 44[mm] 38[mm] 38[mm] 32[mm] 32[mm] 26[mm] 26[mm] 23[mm] 18.4[mm].
- 5 In the **z** text field, type -44.1[mm] -44.1[mm] -42.1[mm] -42.1[mm] -46.1[mm] -46.1[mm] -42.1[mm] -42.1[mm] -46.1[mm] -46.1[mm] -44.1[mm] -44.1[mm] -44.5[mm] -44.5[mm] -46.5[mm] -46.5[mm] -42.5[mm] -42.5[mm] -46.5[mm] -46.5[mm] -42.5[mm] -42.5[mm] -44.5[mm] -44.5[mm].

Polygon 3 (pol3)

- 1 In the **Geometry** toolbar, click  **Polygon**.
- 2 In the **Settings** window for **Polygon**, locate the **Coordinates** section.
- 3 From the **Data source** list, choose **Vectors**.
- 4 In the **r** text field, type 18.4[mm] 66[mm] 66[mm] 67.5[mm] 67.5[mm] 18.4[mm] 18.4[mm] 18.4[mm].
- 5 In the **z** text field, type -39[mm] 0 0 0 0 -40.26[mm] -40.26[mm] -39[mm].

Quadratic Bézier 1 (qb1)

- 1 In the **Geometry** toolbar, click  **More Primitives** and choose **Quadratic Bézier**.
- 2 In the **Settings** window for **Quadratic Bézier**, locate the **Control Points** section.
- 3 In row **1**, set **r** to -18.2[mm].
- 4 In row **3**, set **r** to 18.2[mm].
- 5 In row **1**, set **z** to -39[mm].

- 6 In row **2**, set **z** to -23.5[mm].
- 7 In row **3**, set **z** to -39[mm].
- 8 Locate the **Weights** section. In the **2** text field, type 1.

Line Segment 1 (ls1)

- 1 In the **Geometry** toolbar, click  **More Primitives** and choose **Line Segment**.
- 2 In the **Settings** window for **Line Segment**, locate the **Starting Point** section.
- 3 From the **Specify** list, choose **Coordinates**.
- 4 Locate the **Endpoint** section. From the **Specify** list, choose **Coordinates**.
- 5 Locate the **Starting Point** section. In the **r** text field, type 18.2[mm].
- 6 Locate the **Endpoint** section. In the **r** text field, type 18.2[mm].
- 7 Locate the **Starting Point** section. In the **z** text field, type -39[mm].
- 8 Locate the **Endpoint** section. In the **z** text field, type -40.26[mm].

Quadratic Bézier 2 (qb2)

- 1 In the **Geometry** toolbar, click  **More Primitives** and choose **Quadratic Bézier**.
- 2 In the **Settings** window for **Quadratic Bézier**, locate the **Control Points** section.
- 3 In row **1**, set **r** to 18.2[mm].
- 4 In row **3**, set **r** to -18.2[mm].
- 5 In row **1**, set **z** to -40.26[mm].
- 6 In row **2**, set **z** to -24.26[mm].
- 7 In row **3**, set **z** to -40.26[mm].
- 8 Locate the **Weights** section. In the **2** text field, type 1.



Line Segment 2 (ls2)

- 1 In the **Geometry** toolbar, click  **More Primitives** and choose **Line Segment**.
- 2 In the **Settings** window for **Line Segment**, locate the **Starting Point** section.
- 3 From the **Specify** list, choose **Coordinates**.
- 4 Locate the **Endpoint** section. From the **Specify** list, choose **Coordinates**.
- 5 Locate the **Starting Point** section. In the **r** text field, type -18.2[mm].
- 6 Locate the **Endpoint** section. In the **r** text field, type -18.2[mm].
- 7 Locate the **Starting Point** section. In the **z** text field, type -40.26[mm].
- 8 Locate the **Endpoint** section. In the **z** text field, type -39[mm].

Fillet 1 (fil1)

- 1 In the **Geometry** toolbar, click  **Fillet**.
- 2 On the object **dif2**, select Points 5–8 only.
- 3 In the **Settings** window for **Fillet**, locate the **Radius** section.
- 4 In the **Radius** text field, type 0.2[mm].

Rectangle 8 (r8)

- 1 In the **Geometry** toolbar, click  **Rectangle**.
- 2 In the **Settings** window for **Rectangle**, locate the **Size and Shape** section.
- 3 In the **Width** text field, type 1.2[mm].
- 4 In the **Height** text field, type 7.6[mm].
- 5 Locate the **Position** section. In the **r** text field, type 17.8[mm].
- 6 In the **z** text field, type -59.8[mm].
- 7 In the **Geometry** toolbar, click  **Build All**.