



# Car Cabin Acoustics — Frequency-Domain Analysis

## *Introduction*

---

The acoustic conditions of a car interior contribute greatly to the overall comfort of the vehicle as perceived by the driver and passengers. Simulations can be performed to optimize for speaker locations of sound systems with respect to mirror sources (sound reflections in the windscreen), damping, for signal processing (DSP) improvement, and other factors.

This model analyses the low- to mid-frequency range performance of the sound system in a car cabin. The cabin is a typical sedan interior, that is, the inside of a hard-top family car. The model studies the frequency response at the location of a microphone array and the modal behavior at low frequencies.

The cabin is considered a small volume within the scope of room acoustics due to a large part of the frequency range of interest being dominated by modal behavior. It is best solved with a wave-based approach, in this case the Finite Element Method (FEM), to accurately determine the acoustic properties inside the volume. The size of the model allows a relatively short computation time in the frequency domain. Up to 1 kHz the model is solved using a direct solver. At higher frequencies it is solved with an iterative approach that uses the complex shifted Laplacian method (CSL).

---

**Note:** In addition to the Acoustics Module, this model requires the AC/DC Module and the CAD Import Module.

---

## Model Definition

The analysis of the car cabin is performed with the *Pressure Acoustics, Frequency Domain* interface. The model geometry, depicted in [Figure 1](#), has a total interior volume of  $3.35 \text{ m}^3$ .

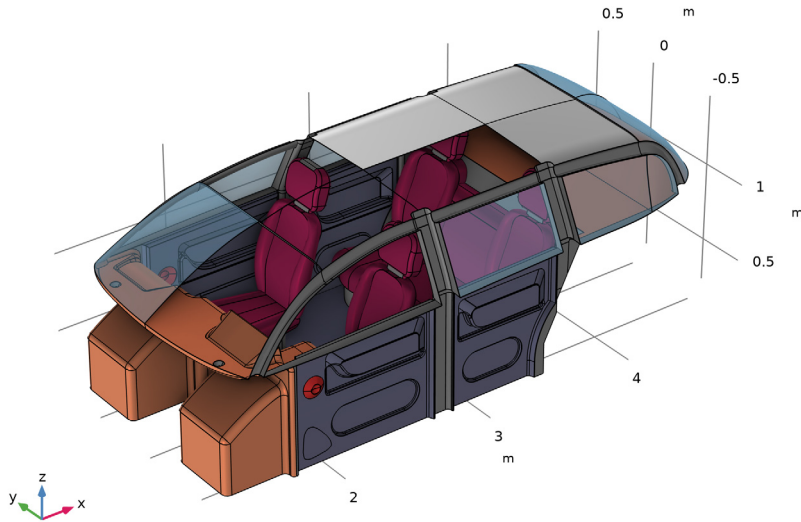

*Figure 1: Geometry of the car cabin.*

The boundary conditions are defined with generic absorption and impedance data. The values used are found under **Global Definition > Parameters 2 - Boundaries**. The windows, dashboard, and doors are modeled using constant absorption coefficients inspired by measurements found in [Ref. 1](#). This is an approximation as only purely resistive losses are modeled; at lower frequencies it can be important to include the reactive part of the impedance to get the correct phase. The complex-valued impedance data of the leather seats is based on experimental values presented in [Ref. 2](#). It is imported into an interpolation function from the file `car_cabin_acoustics_impedance_seats.txt`. The roof trim and the carpet floor are defined using the **Porous layer** option in the **Impedance** boundary condition. The porous materials are modeled with the semi-empirical **Delany-Bazley-Miki** poroacoustic model, using Qunli's and Miki's constants to describe the

foam and fiber materials, respectively. The resulting absorption coefficients of selected surfaces at 2000 Hz can be seen in [Figure 2](#).

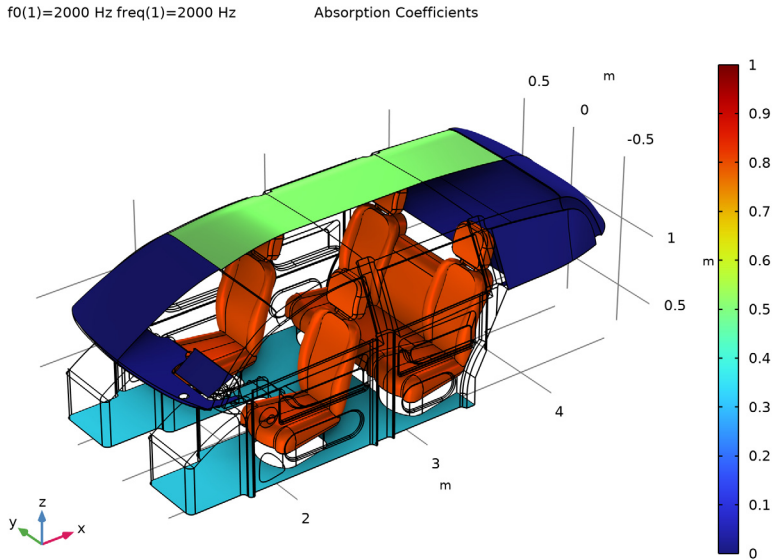
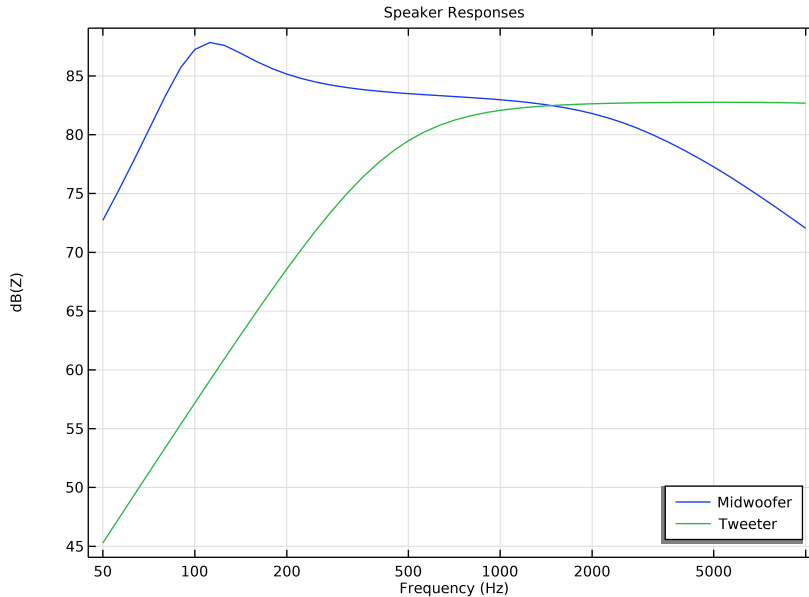

*Figure 2: Absorption coefficients of various surfaces at 2000 Hz.*

The model is driven by loudspeakers placed in the typical locations of a car interior. A lumped Thiele/Small representation (of the electrical and mechanical domains) is implemented with the *Electrical Circuit* interface for a generic midwoofer and a generic tweeter. They are coupled to the acoustic domain using the **Lumped Speaker Boundary** condition. Protective grid covers are also modeled in front of the speakers using the **Interior Perforated Plate** condition. Generic values are used for the perforation configuration.

The loudspeakers are also described with a full lumped models, comprising the electrical, mechanical, and acoustical parts. This analysis gives a fast approximate response of the speakers. For the lumped acoustic circuit, including the radiation impedance and compliance of the closed back volume, see [Ref. 3](#). The impedance and back volume compliance is defined in **Definitions > Variables 2 Electrical Circuit**, using analytic functions for the piston impedance and Struve function. The lumped frequency response of the speakers, when placed in an infinite baffle, is shown in [Figure 3](#). Note that the cross over only happens at about 1000 Hz.

The lumped (Thiele/Small) representation is a low-frequency approximation that is typically valid as long as the transducers retain their piston behavior. The approximation is no longer valid when breakup occurs (mechanical modes in the speaker structures). Using the lumped speaker boundary feature will, however, give a good assessment of the overall acoustic behavior.



*Figure 3: Frequency response of the tweeter and midwoofer loudspeakers. Response curves from a full lumped model.*

The cabin response is first solved with a 1/12 octave resolution from 50 Hz to 1 kHz using a direct solver. To reduce the model size and save disk space the solution is only stored on a microphone array. The model is further solved at 2 kHz, 3 kHz, and 4 kHz using an iterative solver. At 4 kHz the solution time is in the order of some minutes (depending on the hardware) and requires about 45 GB of RAM. Running the model (which is a full wave simulation) to a high frequency before switching to, for example, ray tracing is readily done.

## *Results and Discussion*

---

The modal analysis allows to investigate the properties of the acoustic domain independently of the excitation. It returns the first eigenfrequencies and their corresponding modes. Two modes are shown in Figure 4, at  $f = 111.24$  Hz and  $f = 129.63$  Hz. The first of these modes can be identified to be equivalent to the (1,1,0)

mode in a rectangular enclosure. The second one appears more complex and stems from the irregular geometry and boundary conditions of the car cabin.

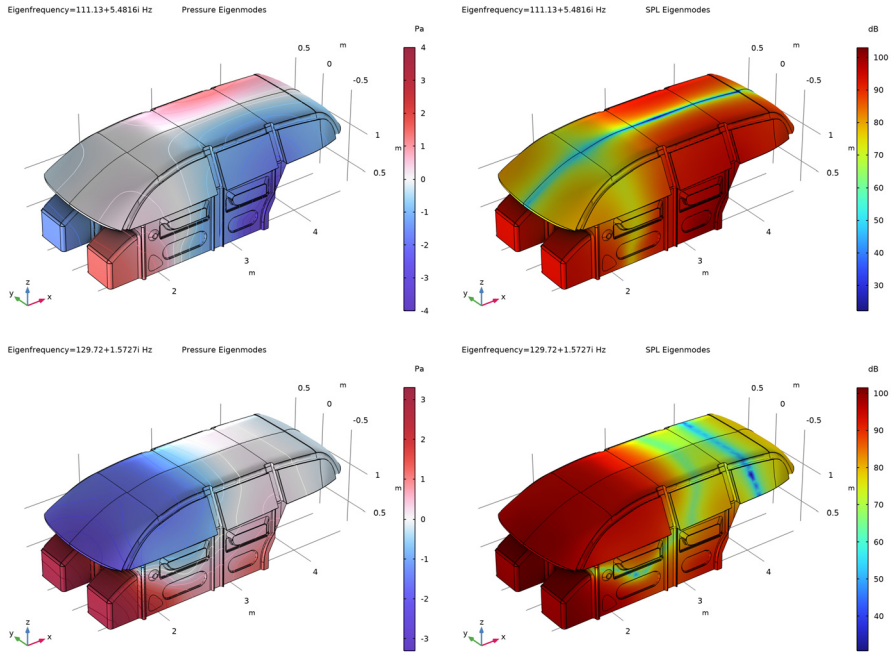

*Figure 4: Eigenmodes of the car cabin. Left column: sound pressure; right column: SPL; top row:  $f = 111.24$  Hz; bottom row:  $f = 129.63$  Hz.*

The frequency response of the car cabin is first considered with both the left midwoofer and the right tweeter active. The result of averaging the sound pressure in three microphone locations corresponding to the driver’s head position is depicted in [Figure 5](#). The **Octave Band** plot comes in handy as it can automatically average over several selected points. The response is shown for a 1/12 octave resolution. The large dips and peaks observed at low frequencies are due to the resonant behavior of the car interior and are seen to coincide with the computed eigenfrequencies. The frequencies solved for in Study 3 and 4 can also be updated to an even finer resolution if needed.

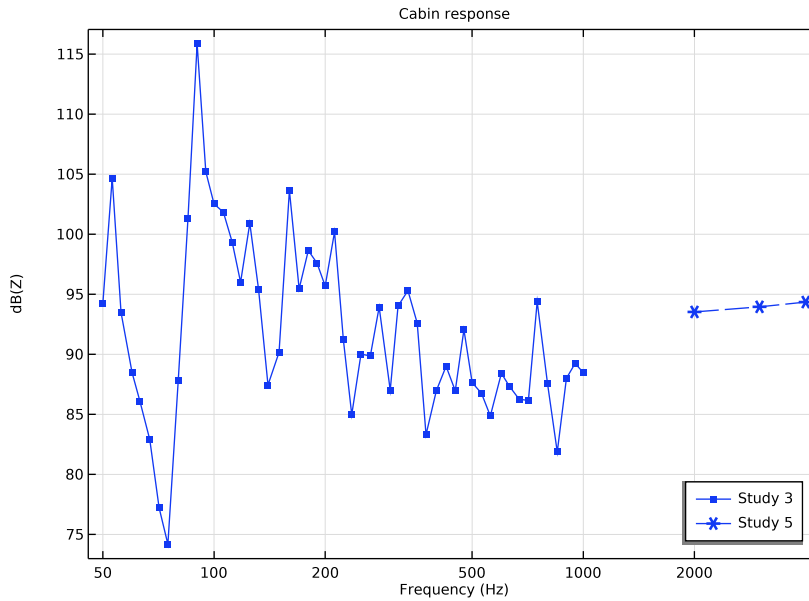

Figure 5: Frequency response of the car cabin with a midwoofer and a tweeter active.

The car cabin is studied with two different loudspeaker setups. In one case, both a midwoofer and a tweeter are active, while in the other case only the tweeter is active. Figure 6 shows the two resulting frequency responses at the same location as previously. This type of comparison allows to identify the frequency ranges where the response is dominated by one or the other loudspeaker. In this example, it is observed that the response from the tweeter becomes important from around 350 Hz and above. It should, however, be pointed out that frequency responses depend on the receiver position (distance to source), and a different result could be found at another location of the car cabin. At even higher frequencies directivity starts to play an important role.

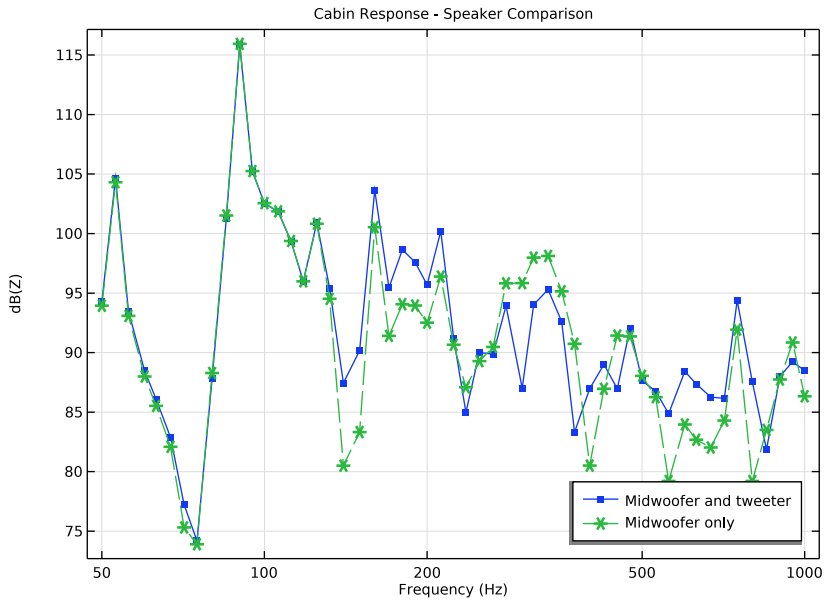
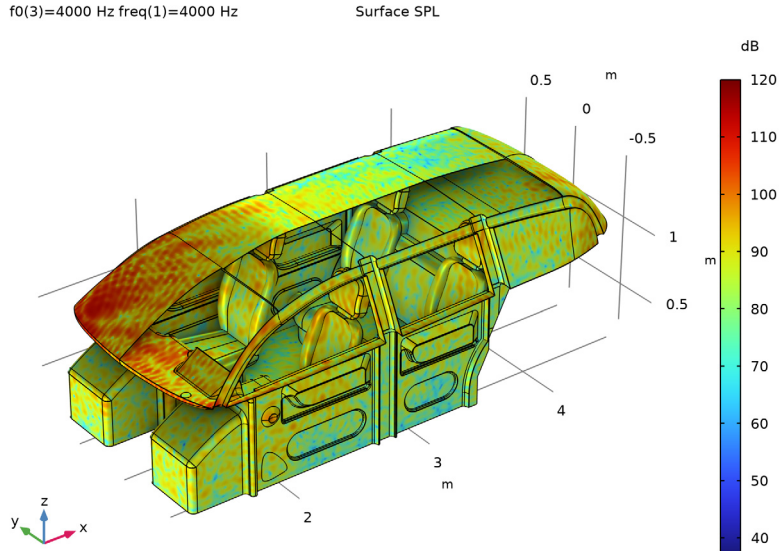

Figure 6: Comparison between loudspeaker setups at the driver location.

In the last study, where the model is solved at 2 kHz, 3 kHz, and 4 kHz, the solution is stored also on the model boundaries. The sound pressure level (SPL) at 4 kHz on all the model surfaces is plotted in Figure 7. Naturally, the SPL is found to be the highest on surfaces close to the dominating sound sources (here the tweeter), such as the dashboard and windshield. The directivity and the reflections in the windshield are also seen. With all the speakers located at the front of the car, it also follows that the SPL is higher on the front seats than on the back seats. This is especially true at high frequencies as depicted here.



*Figure 7: SPL inside the car cabin at 4000 Hz.*

### *Notes About the COMSOL Implementation*

Several actions are taken in this model in order to reduce computation time:

- The imported CAD geometry is a complex model with many small edges and surfaces, which can lead to an unnecessarily large number of mesh elements. The CAD geometry is defeatured using the automatic **Remove Details** functionality.
- The mesh optimization is set to avoid small elements. Small mesh details are also avoided by manually controlling the options of the mesh generation.
- In the low-frequency range (below 1000 Hz) the model is solved using the default direct solver. The **Block low rank factorization** option is turned on as it improves the solver performance in this case.
- At high frequencies, the solution is found via an iterative solver with the complex shifted Laplacian (CSL) method. The solver is one of the predefined iterative solver suggestions. This method ensures convergence at a faster rate and with a significantly smaller memory consumption than the default direct solver.
- The variable fields calculated in the frequency studies are only stored for the points in the microphone array. In the last study with three single (higher) frequencies, the

solution is also stored on the geometry boundaries. This allows to reduce the size of the saved file.

## References

---

1. T.J. Cox and P. D'Antonio, *Acoustic Absorbers and Diffusers: Theory, design and application*, Taylor & Francis, 2009.
2. P. Didier, "In situ estimation of the acoustic properties of vehicle interiors," M.Sc. thesis, DTU Electrical Engineering, 2019.
3. W.M. Leach, Jr., *Introduction to Electroacoustics and Audio Amplifier Design*, 4th ed., Kendall Hunt, 2010.

---

**Application Library path:** Acoustics\_Module/Automotive/car\_cabin\_acoustics

---

## Modeling Instructions



---

From the **File** menu, choose **New**.

### NEW

In the **New** window, click  **Model Wizard**.

### MODEL WIZARD



- 1 In the **Model Wizard** window, click  **3D**.
- 2 In the **Select Physics** tree, select **Acoustics > Pressure Acoustics > Pressure Acoustics, Frequency Domain (acpr)**.
- 3 Click **Add**.
- 4 In the **Select Physics** tree, select **AC/DC > Electrical Circuit (cir)**.
- 5 Click **Add**.
- 6 Click **Add**.
- 7 Click  **Study**.
- 8 In the **Select Study** tree, select **General Studies > Frequency Domain**.
- 9 Click  **Done**.

## GEOMETRY I

Start by importing the geometry from an MPHBIN-file. Then, create faces for the loudspeaker covers and points to represent a microphone array at the front of the car cabin.

- 1 In the **Model Builder** window, under **Component 1 (comp1)** click **Geometry 1**.
- 2 In the **Settings** window for **Geometry**, locate the **Advanced** section.
- 3 From the **Geometry representation** list, choose **CAD kernel**.
- 4 From the **Default repair tolerance** list, choose **Relative**.

### *Import 1 (imp1)*

- 1 In the **Geometry** toolbar, click  **Import**.
- 2 In the **Settings** window for **Import**, locate the **Source** section.
- 3 Click  **Browse**.
- 4 Browse to the model's Application Libraries folder and double-click the file `car_cabin_acoustics_geometry.mphbin`.

### *Cap Faces 1 (cap1)*

- 1 In the **Geometry** toolbar, click  **Defeaturing and Repair** and choose **Cap Faces**.
- 2 Click the  **Wireframe Rendering** button in the **Graphics** toolbar.
- 3 On the object **imp1**, select Edges 53, 54, 56, 57, 389, 390, 392, and 393 only.

### *Point 1 (pt1)*

- 1 In the **Geometry** toolbar, click  **More Primitives** and choose **Point**.
- 2 In the **Settings** window for **Point**, locate the **Point** section.
- 3 In the **x** text field, type 2.
- 4 In the **y** text field, type -0.55.
- 5 In the **z** text field, type 1.2.

### *Array 1 (arr1)*

- 1 In the **Geometry** toolbar, click  **Transforms** and choose **Array**.
- 2 Select the object **pt1** only.
- 3 In the **Settings** window for **Array**, locate the **Size** section.
- 4 In the **x size** text field, type 6.
- 5 In the **y size** text field, type 12.
- 6 Locate the **Displacement** section. In the **x** text field, type 0.1.
- 7 In the **y** text field, type 0.1.

- 8 Locate the **Selections of Resulting Entities** section. Select the **Resulting objects selection** checkbox.
- 9 Find the **Cumulative selection** subsection. Click **New**.
- 10 In the **New Cumulative Selection** dialog, type Microphone Array in the **Name** text field.
- 11 Click **OK**.

#### *Microphone Array (Domain)*

- 1 In the **Model Builder** window, expand the **Component 1 (comp1) > Geometry 1 > Cumulative Selections** node, then click **Microphone Array (Domain)**.
- 2 In the **Settings** window for **Selection**, locate the **Resulting Selection** section.
- 3 Clear the **Show in physics** checkbox.

#### *Microphone Array (Boundary)*

- 1 In the **Model Builder** window, click **Microphone Array (Boundary)**.
- 2 In the **Settings** window for **Selection**, locate the **Resulting Selection** section.
- 3 Clear the **Show in physics** checkbox.

#### *Microphone Array (Edge)*

- 1 In the **Model Builder** window, click **Microphone Array (Edge)**.
- 2 In the **Settings** window for **Selection**, locate the **Resulting Selection** section.
- 3 Clear the **Show in physics** checkbox.

Proceed with creating explicit selections to group the different types of boundary surfaces together.

#### *Windows*

- 1 In the **Geometry** toolbar, click  **Selections** and choose **Explicit Selection**.
- 2 In the **Settings** window for **Explicit Selection**, type Windows in the **Label** text field.
- 3 Locate the **Entities to Select** section. From the **Geometric entity level** list, choose **Boundary**.
- 4 On the object **ige1**, select Boundaries 3, 4, 62, 63, 507, 515, 807, 814, 838, 841, 844, and 845 only.

#### *Dashboard*



- 1 In the **Geometry** toolbar, click  **Selections** and choose **Explicit Selection**.
- 2 In the **Settings** window for **Explicit Selection**, type Dashboard in the **Label** text field.
- 3 Locate the **Entities to Select** section. From the **Geometric entity level** list, choose **Boundary**.

- 4 Click the  **Paste Selection** button for **Entities to select**.
- 5 In the **Paste Selection** dialog, type ige1: 1, 2, 5-9, 11-30, 42-44, 47-52, 54-57, 64-71, 85-92, 95-97, 99-109, 115-119, 121-127, 130-145, 147-150, 152, 153, 162-166, 328-330, 335-339, 341, 792, 839 in the **Selection** text field.
- 6 Click **OK**.



#### *Carpet floor*

- 1 In the **Geometry** toolbar, click  **Selections** and choose **Explicit Selection**.
- 2 In the **Settings** window for **Explicit Selection**, type Carpet floor in the **Label** text field.
- 3 Locate the **Entities to Select** section. From the **Geometric entity level** list, choose **Boundary**.
- 4 On the object **ige1**, select Boundary 10 only.

#### *Doors*

- 1 In the **Geometry** toolbar, click  **Selections** and choose **Explicit Selection**.
- 2 In the **Settings** window for **Explicit Selection**, type Doors in the **Label** text field.
- 3 Locate the **Entities to Select** section. From the **Geometric entity level** list, choose **Boundary**.
- 4 Click the  **Paste Selection** button for **Entities to select**.
- 5 In the **Paste Selection** dialog, type ige1: 155, 157-161, 167, 168, 175, 176, 181-203, 212-215, 218-236, 259, 261-267, 273, 281, 282, 284, 285, 296-310, 314, 322-327, 367-370, 373-386, 389-400, 413, 414, 435, 436, 445, 446, 458, 509, 519-587, 593, 594, 607-620, 639-644, 647-661, 663-672, 680-691, 695, 697-706 in the **Selection** text field.
- 6 Click **OK**.



#### *Leather seats*

- 1 In the **Geometry** toolbar, click  **Selections** and choose **Explicit Selection**.
- 2 In the **Settings** window for **Explicit Selection**, type Leather seats in the **Label** text field.
- 3 Locate the **Entities to Select** section. From the **Geometric entity level** list, choose **Boundary**.
- 4 Click the  **Paste Selection** button for **Entities to select**.
- 5 In the **Paste Selection** dialog, type ige1: 204, 205, 208, 209, 216, 217, 237, 238, 240-242, 245, 246, 249, 250, 253-256, 282, 288-295, 310, 311, 314-317, 343-352, 357-366, 371, 372, 387, 388, 395, 401-412, 417-434, 437-444, 447-453, 467-473, 483-494, 588, 589, 591, 592, 595-606, 621, 622,

628-638, 673-679, 686, 695, 696, 707, 708, 723, 734-747, 752-774, 783-790, 793-802, 816-835 in the **Selection** text field.

6 Click **OK**.

#### *Roof trim*

- 1 In the **Geometry** toolbar, click  **Selections** and choose **Explicit Selection**.
- 2 In the **Settings** window for **Explicit Selection**, type Roof trim in the **Label** text field.
- 3 Locate the **Entities to Select** section. From the **Geometric entity level** list, choose **Boundary**.
- 4 Click the  **Paste Selection** button for **Entities to select**.
- 5 In the **Paste Selection** dialog, type ige1: 270, 271, 495, 496, 748, 749 in the **Selection** text field.
- 6 Click **OK**.

#### *Speaker Covers*

- 1 In the **Geometry** toolbar, click  **Selections** and choose **Explicit Selection**.
- 2 In the **Settings** window for **Explicit Selection**, type Speaker Covers in the **Label** text field.
- 3 Locate the **Entities to Select** section. From the **Geometric entity level** list, choose **Boundary**.
- 4 On the object **ige1**, select Boundaries 33, 36, 171, and 174 only.

#### *Midwoofer L*

- 1 In the **Geometry** toolbar, click  **Selections** and choose **Explicit Selection**.
- 2 In the **Settings** window for **Explicit Selection**, type Midwoofer L in the **Label** text field.
- 3 Locate the **Entities to Select** section. From the **Geometric entity level** list, choose **Boundary**.
- 4 On the object **ige1**, select Boundaries 169, 170, 177, and 178 only.

#### *Midwoofer R*

- 1 In the **Geometry** toolbar, click  **Selections** and choose **Explicit Selection**.
- 2 In the **Settings** window for **Explicit Selection**, type Midwoofer R in the **Label** text field.
- 3 Locate the **Entities to Select** section. From the **Geometric entity level** list, choose **Boundary**.
- 4 On the object **ige1**, select Boundaries 172, 173, 179, and 180 only.

#### *Tweeter R*

- 1 In the **Geometry** toolbar, click  **Selections** and choose **Explicit Selection**.
- 2 In the **Settings** window for **Explicit Selection**, type Tweeter R in the **Label** text field.
- 3 Locate the **Entities to Select** section. From the **Geometric entity level** list, choose **Boundary**.
- 4 On the object **ige1**, select Boundaries 39 and 40 only.



#### *Tweeter L*

- 1 In the **Geometry** toolbar, click  **Selections** and choose **Explicit Selection**.
- 2 In the **Settings** window for **Explicit Selection**, type Tweeter L in the **Label** text field.
- 3 Locate the **Entities to Select** section. From the **Geometric entity level** list, choose **Boundary**.
- 4 On the object **ige1**, select Boundaries 37 and 38 only.

#### *Remove Details 1 (rmd1)*

In the **Geometry** toolbar, click  **Virtual Operations** and choose **Remove Details**.

#### *Ignore Edges 2 (ige2)*

- 1 In the **Geometry** toolbar, click  **Virtual Operations** and choose **Ignore Edges**.
- 2 In the **Settings** window for **Ignore Edges**, locate the **Input** section.
- 3 Click the  **Paste Selection** button for **Edges to ignore**.
- 4 In the **Paste Selection** dialog, type 1178, 1183, 1191, 1678, 1686 in the **Selection** text field.
- 5 Click **OK**.
- 6 In the **Geometry** toolbar, click  **Build All**.

## **DEFINITIONS**

Change the view settings to improve the rendering of 3D plots.

#### *View 1*

- 1 In the **Model Builder** window, expand the **Component 1 (comp1) > Definitions** node, then click **View 1**.
- 2 In the **Settings** window for **View**, click to expand the **Visual Effects** section.
- 3 Select the **Ambient occlusion** checkbox.



Import the model parameters from text files. These include the ambient conditions and boundary conditions for acoustics, as well as parameter values for the loudspeaker electrical circuits.

## GLOBAL DEFINITIONS



### *Parameters 1 - Model*

- 1 In the **Model Builder** window, under **Global Definitions** click **Parameters 1**.
- 2 In the **Settings** window for **Parameters**, type Parameters 1 - Model in the **Label** text field.
- 3 Locate the **Parameters** section. Click  **Load from File**.
- 4 Browse to the model's Application Libraries folder and double-click the file `car_cabin_acoustics_parameters_model.txt`.



### *Parameters 2 - Boundaries*

- 1 In the **Home** toolbar, click  **Parameters** and choose **Add > Parameters**.
- 2 In the **Settings** window for **Parameters**, type Parameters 2 - Boundaries in the **Label** text field.
- 3 Locate the **Parameters** section. Click  **Load from File**.
- 4 Browse to the model's Application Libraries folder and double-click the file `car_cabin_acoustics_parameters_boundaries.txt`.

### *Parameters 3 - Midwoofer*

- 1 In the **Home** toolbar, click  **Parameters** and choose **Add > Parameters**.
- 2 In the **Settings** window for **Parameters**, type Parameters 3 - Midwoofer in the **Label** text field.
- 3 Locate the **Parameters** section. Click  **Load from File**.
- 4 Browse to the model's Application Libraries folder and double-click the file `car_cabin_acoustics_parameters_midwoofer.txt`.

### *Parameters 4 - Tweeter*

- 1 In the **Home** toolbar, click  **Parameters** and choose **Add > Parameters**.
- 2 In the **Settings** window for **Parameters**, type Parameters 4 - Tweeter in the **Label** text field.
- 3 Locate the **Parameters** section. Click  **Load from File**.
- 4 Browse to the model's Application Libraries folder and double-click the file `car_cabin_acoustics_parameters_tweeter.txt`.

### *Interpolation 1 - Leather Seats*

- 1 In the **Home** toolbar, click  **Functions** and choose **Global > Interpolation**.
- 2 In the **Settings** window for **Interpolation**, type Interpolation 1 - Leather Seats in the **Label** text field.

- 3 Locate the **Definition** section. From the **Data source** list, choose **File**.
- 4 Click  **Browse**.
- 5 Browse to the model's Application Libraries folder and double-click the file `car_cabin_acoustics_impedance_seats.txt`.
- 6 Locate the **Data Column Settings** section. In the table, click to select the cell at row number 1 and column number 1.
- 7 In the **Unit** text field, type Hz.
- 8 In the table, enter the following settings:

Columns	Type	Settings
Column 2	Function values	Function name=realZ_seat

- 9 In the **Name** text field, type `realZ_seat`.
- 10 In the **Unit** text field, type 1.
- 11 In the table, click to select the cell at row number 3 and column number 1.
- 12 In the **Name** text field, type `imagZ_seat`.
- 13 In the **Unit** text field, type 1.
- 14 Locate the **Interpolation and Extrapolation** section. From the **Interpolation** list, choose **Piecewise cubic**.
- 15 Locate the **Definition** section. Click  **Import**.

*Analytic 1 - Struve Function (Order One)*

- 1 In the **Home** toolbar, click  **Functions** and choose **Global > Analytic**.
- 2 In the **Settings** window for **Analytic**, type Analytic 1 - Struve Function (Order One) in the **Label** text field.
- 3 In the **Function name** text field, type `h1`.
- 4 Locate the **Definition** section. In the **Expression** text field, type  $2/\pi - \text{besselj}(0, x) + (16/\pi - 5) * \sin(x) / x + (12 - 36/\pi) * (1 - \cos(x)) / x^2$ .
- 5 Locate the **Units** section. In the **Function** text field, type 1.
- 6 In the table, enter the following settings:

Argument	Unit
x	1

- 7 Click to expand the **Advanced** section. Select the **May produce complex output for real arguments** checkbox.

8 Locate the **Plot Parameters** section. In the table, enter the following settings:

Plot	Argument	Lower limit	Upper limit	Fixed value	Unit
√	x	0	10	0	I

#### Analytic 2 - Piston Impedance



- 1 In the **Home** toolbar, click  **Functions** and choose **Global > Analytic**.
- 2 In the **Settings** window for **Analytic**, type Analytic 2 - Piston Impedance in the **Label** text field.
- 3 In the **Function name** text field, type Zp.
- 4 Locate the **Definition** section. In the **Expression** text field, type  $\rho_0 \cdot c_0 \cdot (1 - \text{besselj}(1, 2 \cdot x) / x + i \cdot h_1(2 \cdot x) / x)$ .
- 5 Locate the **Units** section. In the **Function** text field, type  $\text{kg} / (\text{s} \cdot \text{m}^2)$ .
- 6 In the table, enter the following settings:

Argument	Unit
x	1

- 7 Locate the **Advanced** section. Select the **May produce complex output for real arguments** checkbox.
- 8 Locate the **Plot Parameters** section. In the table, enter the following settings:

Plot	Argument	Lower limit	Upper limit	Fixed value	Unit
√	x	0	10	0	I

#### ADD MATERIAL

- 1 In the **Home** toolbar, click  **Add Material** to open the **Add Material** window.
- 2 Go to the **Add Material** window.
- 3 In the tree, select **Built-in > Air**.
- 4 Click the **Add to Component** button in the window toolbar.
- 5 In the **Home** toolbar, click  **Add Material** to close the **Add Material** window.

#### DEFINITIONS

##### Variables 1 - Acoustics

- 1 In the **Model Builder** window, under **Component 1 (comp1)** right-click **Definitions** and choose **Variables**.

- 2 In the **Settings** window for **Variables**, type Variables 1 - Acoustics in the **Label** text field.
- 3 Locate the **Variables** section. Click  **Load from File**.
- 4 Browse to the model's Application Libraries folder and double-click the file `car_cabin_acoustics_variables_acoustics.txt`.



#### *Variables 2 - Electrical Circuits*

- 1 In the **Model Builder** window, right-click **Definitions** and choose **Variables**.
- 2 In the **Settings** window for **Variables**, type Variables 2 - Electrical Circuits in the **Label** text field.
- 3 Locate the **Variables** section. Click  **Load from File**.
- 4 Browse to the model's Application Libraries folder and double-click the file `car_cabin_acoustics_variables_electrical_circuits.txt`.

#### *All Boundaries*

- 1 In the **Definitions** toolbar, click  **Explicit**.
- 2 In the **Settings** window for **Explicit**, type All Boundaries in the **Label** text field.
- 3 Locate the **Input Entities** section. From the **Geometric entity level** list, choose **Boundary**.
- 4 Select the **All boundaries** checkbox.

#### *Sound Hard Surfaces*

- 1 In the **Definitions** toolbar, click  **Difference**.
- 2 In the **Settings** window for **Difference**, type Sound Hard Surfaces in the **Label** text field.
- 3 Locate the **Geometric Entity Level** section. From the **Level** list, choose **Boundary**.
- 4 Locate the **Input Entities** section. Under **Selections to add**, click  **Add**.
- 5 In the **Add** dialog, select **All Boundaries** in the **Selections to add** list.
- 6 Click **OK**.
- 7 In the **Settings** window for **Difference**, locate the **Input Entities** section.
- 8 Under **Selections to subtract**, click  **Add**.
- 9 In the **Add** dialog, in the **Selections to subtract** list, choose **Windows, Dashboard, Carpet floor, Doors, Leather seats, Roof trim, Speaker Covers, Midwoofer L, Midwoofer R, Tweeter R, and Tweeter L**.
- 10 Click **OK**.

#### *All Speakers*

- 1 In the **Definitions** toolbar, click  **Union**.

- 2 In the **Settings** window for **Union**, type All Speakers in the **Label** text field.
- 3 Locate the **Geometric Entity Level** section. From the **Level** list, choose **Boundary**.
- 4 Locate the **Input Entities** section. Under **Selections to add**, click **+ Add**.
- 5 In the **Add** dialog, in the **Selections to add** list, choose **Midwoofer L**, **Midwoofer R**, **Tweeter R**, and **Tweeter L**.
- 6 Click **OK**.

Now set up the physics of the model. Boundary conditions are defined with the **Impedance** feature. A generic midwoofer and a generic tweeter are modeled as electrical circuits that are coupled to the acoustic domain with the **Lumped Speaker Boundary** feature.

## PRESSURE ACOUSTICS, FREQUENCY DOMAIN (ACPR)

### *Pressure Acoustics 1*

- 1 In the **Model Builder** window, under **Component 1 (comp1) > Pressure Acoustics**, **Frequency Domain (acpr)** click **Pressure Acoustics 1**.
- 2 In the **Settings** window for **Pressure Acoustics**, locate the **Pressure Acoustics Model** section.
- 3 From the **Fluid model** list, choose **Atmosphere attenuation**.
- 4 Locate the **Model Input** section. In the  $\phi_w$  text field, type  $re1H$ .

### *Impedance 1 - Windows*

- 1 In the **Physics** toolbar, click  **Boundaries** and choose **Impedance**.
- 2 In the **Settings** window for **Impedance**, type Impedance 1 - Windows in the **Label** text field.
- 3 Locate the **Boundary Selection** section. From the **Selection** list, choose **Windows**.
- 4 Locate the **Impedance** section. From the **Impedance model** list, choose **Absorption coefficient**.
- 5 In the  $\alpha_n$  text field, type  $alpha\_win$ .

### *Impedance 2 - Dashboard*

- 1 In the **Physics** toolbar, click  **Boundaries** and choose **Impedance**.
- 2 In the **Settings** window for **Impedance**, type Impedance 2 - Dashboard in the **Label** text field.
- 3 Locate the **Boundary Selection** section. From the **Selection** list, choose **Dashboard**.
- 4 Locate the **Impedance** section. From the **Impedance model** list, choose **Absorption coefficient**.

5 In the  $\alpha_n$  text field, type alpha\_dash.

#### *Impedance 3 - Carpet Floor*

- 1 In the **Physics** toolbar, click  **Boundaries** and choose **Impedance**.
- 2 In the **Settings** window for **Impedance**, type Impedance 3 - Carpet Floor in the **Label** text field.
- 3 Locate the **Boundary Selection** section. From the **Selection** list, choose **Carpet floor**.
- 4 Locate the **Impedance** section. From the **Impedance model** list, choose **Porous layer**.
- 5 In the  $d$  text field, type d\_carp.
- 6 From the **Direction of incident wave** list, choose **Automatic**.
- 7 Locate the **Fluid Properties** section. From the **Fluid material** list, choose **Air (mat1)**.
- 8 Locate the **Porous Matrix Properties** section. From the **Porous elastic material** list, choose **Air (mat1)**.
- 9 From the  $R_f$  list, choose **User defined**. In the associated text field, type Rf\_carp.
- 10 From the **Constants** list, choose **Miki**.

#### *Impedance 4 - Doors*

- 1 In the **Physics** toolbar, click  **Boundaries** and choose **Impedance**.
- 2 In the **Settings** window for **Impedance**, type Impedance 4 - Doors in the **Label** text field.
- 3 Locate the **Boundary Selection** section. From the **Selection** list, choose **Doors**.
- 4 Locate the **Impedance** section. From the **Impedance model** list, choose **Absorption coefficient**.
- 5 In the  $\alpha_n$  text field, type alpha\_door.

#### *Impedance 5 - Leather Seats*

- 1 In the **Physics** toolbar, click  **Boundaries** and choose **Impedance**.
- 2 In the **Settings** window for **Impedance**, type Impedance 5 - Leather Seats in the **Label** text field.
- 3 Locate the **Boundary Selection** section. From the **Selection** list, choose **Leather seats**.
- 4 Locate the **Impedance** section. In the  $Z_n$  text field, type Zn\_seat.

#### *Impedance 6 - Roof Trim*

- 1 In the **Physics** toolbar, click  **Boundaries** and choose **Impedance**.
- 2 In the **Settings** window for **Impedance**, type Impedance 6 - Roof Trim in the **Label** text field.

- 3 Locate the **Boundary Selection** section. From the **Selection** list, choose **Roof trim**.
- 4 Locate the **Impedance** section. From the **Impedance model** list, choose **Porous layer**.
- 5 In the  $d$  text field, type `d_roof`.
- 6 From the **Direction of incident wave** list, choose **Automatic**.
- 7 Locate the **Fluid Properties** section. From the **Fluid material** list, choose **Air (mat1)**.
- 8 Locate the **Porous Matrix Properties** section. From the **Porous elastic material** list, choose **Air (mat1)**.
- 9 From the  $R_f$  list, choose **User defined**. In the associated text field, type `Rf_roof`.
- 10 From the **Constants** list, choose **Qunli**.

Constants are taken from Qunli's model to represent thin foam layers.

#### *Interior Perforated Plate 1*

- 1 In the **Physics** toolbar, click  **Boundaries** and choose **Interior Perforated Plate**.
- 2 In the **Settings** window for **Interior Perforated Plate**, locate the **Boundary Selection** section.
- 3 From the **Selection** list, choose **Speaker Covers**.
- 4 Locate the **Interior Perforated Plate** section. In the  $\sigma$  text field, type `0.5`.
- 5 Locate the **Fluid Properties** section. From the **Fluid material** list, choose **Air (mat1)**.

#### *Lumped Speaker Boundary 1 - Midwoofer L*

- 1 In the **Physics** toolbar, click  **Boundaries** and choose **Lumped Speaker Boundary**.
- 2 In the **Settings** window for **Lumped Speaker Boundary**, type `Lumped Speaker Boundary 1 - Midwoofer L` in the **Label** text field.
- 3 Locate the **Boundary Selection** section. From the **Selection** list, choose **Midwoofer L**.
- 4 Locate the **Back Volume Correction** section. In the  $V_{\text{back}}$  text field, type `Vback_m`.

#### *Lumped Speaker Boundary 2 - Tweeter R*

- 1 In the **Physics** toolbar, click  **Boundaries** and choose **Lumped Speaker Boundary**.
- 2 In the **Settings** window for **Lumped Speaker Boundary**, type `Lumped Speaker Boundary 2 - Tweeter R` in the **Label** text field.
- 3 Locate the **Boundary Selection** section. From the **Selection** list, choose **Tweeter R**.
- 4 Locate the **Back Volume Correction** section. In the  $V_{\text{back}}$  text field, type `Vback_t`.

### **ELECTRICAL CIRCUIT - MIDWOOFER**

- 1 In the **Model Builder** window, under **Component 1 (comp1)** click **Electrical Circuit (cir)**.

2 In the **Settings** window for **Electrical Circuit**, type **Electrical Circuit - Midwoofer** in the **Label** text field.

*Voltage Source 1 (V1)*

In the **Electrical Circuit** toolbar, click  **Voltage Source**.

*Resistor 1 (R1)*

In the **Electrical Circuit** toolbar, click  **Resistor**.

*Inductor 1 (L1)*

In the **Electrical Circuit** toolbar, click  **Inductor**.

*Current-Controlled Voltage Source 1 (H1)*

In the **Electrical Circuit** toolbar, click  **Current-Controlled Voltage Source**.

*Current-Controlled Voltage Source 2 (H2)*

In the **Electrical Circuit** toolbar, click  **Current-Controlled Voltage Source**.

*Inductor 2 (L2)*

In the **Electrical Circuit** toolbar, click  **Inductor**.

*Resistor 2 (R2)*

In the **Electrical Circuit** toolbar, click  **Resistor**.

*Capacitor 1 (C1)*

In the **Electrical Circuit** toolbar, click  **Capacitor**.

*External I vs. U 1 (IvsU1)*

In the **Electrical Circuit** toolbar, click  **External I vs. U**.

*Voltage-Controlled Voltage Source 1 (E1)*

In the **Electrical Circuit** toolbar, click  **Voltage-Controlled Voltage Source**.

*Current-Controlled Current Source 1 (F1)*

In the **Electrical Circuit** toolbar, click  **Current-Controlled Current Source**.

*Resistor 3 (R3)*

In the **Electrical Circuit** toolbar, click  **Resistor**.

*Resistor 4 (R4)*

In the **Electrical Circuit** toolbar, click  **Resistor**.

*Voltage Source 1 (V1)*

1 In the **Model Builder** window, click **Voltage Source 1 (V1)**.

2 In the **Settings** window for **Voltage Source**, locate the **Node Connections** section.

3 In the table, enter the following settings:

Label	Node names
n	0

4 Locate the **Device Parameters** section. In the  $v_{\text{src}}$  text field, type V0.

*Resistor 1 (R1)*

1 In the **Model Builder** window, click **Resistor 1 (R1)**.

2 In the **Settings** window for **Resistor**, locate the **Node Connections** section.

3 In the table, enter the following settings:

Label	Node names
p	1
n	2

4 Locate the **Device Parameters** section. In the  $R$  text field, type R1\_m.

*Inductor 1 (L1)*

1 In the **Model Builder** window, click **Inductor 1 (L1)**.

2 In the **Settings** window for **Inductor**, locate the **Node Connections** section.

3 In the table, enter the following settings:

Label	Node names
p	2
n	3

4 Locate the **Device Parameters** section. In the  $L$  text field, type L1\_m.

*Current-Controlled Voltage Source 1 (H1)*

1 In the **Model Builder** window, click **Current-Controlled Voltage Source 1 (H1)**.

2 In the **Settings** window for **Current-Controlled Voltage Source**, locate the **Node Connections** section.

3 In the table, enter the following settings:

Label	Node names
p	3
n	0

4 Locate the **Current Measurement** section. From the **Measure current for device** list, choose **Inductor 2 (L2)**.

5 Locate the **Device Parameters** section. In the **Gain** text field, type  $A_m$ .

*Current-Controlled Voltage Source 2 (H2)*

1 In the **Model Builder** window, click **Current-Controlled Voltage Source 2 (H2)**.

2 In the **Settings** window for **Current-Controlled Voltage Source**, locate the **Node Connections** section.

3 In the table, enter the following settings:

Label	Node names
p	6
n	0

4 Locate the **Current Measurement** section. From the **Measure current for device** list, choose **Resistor 1 (R1)**.

5 Locate the **Device Parameters** section. In the **Gain** text field, type  $A_m$ .

*Inductor 2 (L2)*

1 In the **Model Builder** window, click **Inductor 2 (L2)**.

2 In the **Settings** window for **Inductor**, locate the **Node Connections** section.

3 In the table, enter the following settings:

Label	Node names
p	6
n	7

4 Locate the **Device Parameters** section. In the  $L$  text field, type  $L2_m$ .

*Resistor 2 (R2)*

1 In the **Model Builder** window, click **Resistor 2 (R2)**.

2 In the **Settings** window for **Resistor**, locate the **Node Connections** section.

3 In the table, enter the following settings:

Label	Node names
p	7
n	8

4 Locate the **Device Parameters** section. In the  $R$  text field, type  $R2_m$ .

### Capacitor 1 (C1)

- 1 In the **Model Builder** window, click **Capacitor 1 (C1)**.
- 2 In the **Settings** window for **Capacitor**, locate the **Node Connections** section.
- 3 In the table, enter the following settings:

Label	Node names
p	8
n	9

- 4 Locate the **Device Parameters** section. In the *C* text field, type C1\_m.

### External I vs. U 1 (IvsU1)

- 1 In the **Model Builder** window, click **External I vs. U 1 (IvsU1)**.
- 2 In the **Settings** window for **External I vs. U**, locate the **External Device** section.
- 3 From the *V* list, choose **Voltage from lumped speaker boundary (acpr/lsb I)**.
- 4 Locate the **Node Connections** section. In the table, enter the following settings:

Label	Node names
p	9
n	0

### Voltage-Controlled Voltage Source 1 (E1)

- 1 In the **Model Builder** window, click **Voltage-Controlled Voltage Source 1 (E1)**.
- 2 In the **Settings** window for **Voltage-Controlled Voltage Source**, locate the **Node Connections** section.
- 3 In the table, enter the following settings:

Label	Node names
p	9
n	0
measure (+)	11
measure (-)	10

- 4 Locate the **Device Parameters** section. In the **Gain** text field, type Sd\_m[1/m^2].

### Current-Controlled Current Source 1 (F1)

- 1 In the **Model Builder** window, click **Current-Controlled Current Source 1 (F1)**.

2 In the **Settings** window for **Current-Controlled Current Source**, locate the **Node Connections** section.

3 In the table, enter the following settings:

Label	Node names
p	10
n	11

4 Locate the **Current Measurement** section. From the **Measure current for device** list, choose **Voltage-Controlled Voltage Source I (EI)**.

5 Locate the **Device Parameters** section. In the **Gain** text field, type  $Sd\_m[1/m^2]$ .

#### *Resistor 3 - Lumped Radiation Impedance*

1 In the **Model Builder** window, under **Component 1 (comp1) > Electrical Circuit - Midwoofer (cir)** click **Resistor 3 (R3)**.

2 In the **Settings** window for **Resistor**, type **Resistor 3 - Lumped Radiation Impedance** in the **Label** text field.

3 Locate the **Node Connections** section. In the table, enter the following settings:

Label	Node names
p	10
n	0

4 Locate the **Device Parameters** section. In the  $R$  text field, type  $Zrad\_m*1[ohm*m^4*s/kg]$ .

5 Locate the **Node Connections** section. In the table, enter the following settings:

Label	Node names
p	10
n	0

#### *Resistor 4 - Lumped Back Volume Compliance*

1 In the **Model Builder** window, under **Component 1 (comp1) > Electrical Circuit - Midwoofer (cir)** click **Resistor 4 (R4)**.

2 In the **Settings** window for **Resistor**, type **Resistor 4 - Lumped Back Volume Compliance** in the **Label** text field.

3 Locate the **Node Connections** section. In the table, enter the following settings:

Label	Node names
p	11
n	0

4 Locate the **Device Parameters** section. In the  $R$  text field, type  $Zbv\_m*1$  [ohm\*m<sup>4</sup>\*s/kg].

#### **ELECTRICAL CIRCUIT 2 - TWEETER**

- 1 In the **Model Builder** window, under **Component 1 (comp1)** click **Electrical Circuit 2 (cir2)**.
- 2 In the **Settings** window for **Electrical Circuit**, type **Electrical Circuit 2 - Tweeter** in the **Label** text field.

#### **ELECTRICAL CIRCUIT - MIDWOOFER (CIR)**

*Capacitor 1 (C1), Current-Controlled Current Source 1 (F1), Current-Controlled Voltage Source 1 (H1), Current-Controlled Voltage Source 2 (H2), External I vs. U 1 (IvsU1), Inductor 1 (L1), Inductor 2 (L2), Resistor 1 (R1), Resistor 2 (R2), Resistor 3 - Lumped Radiation Impedance (R3), Resistor 4 - Lumped Back Volume Compliance (R4), Voltage Source 1 (V1), Voltage-Controlled Voltage Source 1 (E1)*

- 1 In the **Model Builder** window, under **Component 1 (comp1) > Electrical Circuit - Midwoofer (cir)**, Ctrl-click to select **Voltage Source 1 (V1), Resistor 1 (R1), Inductor 1 (L1), Current-Controlled Voltage Source 1 (H1), Current-Controlled Voltage Source 2 (H2), Inductor 2 (L2), Resistor 2 (R2), Capacitor 1 (C1), External I vs. U 1 (IvsU1), Voltage-Controlled Voltage Source 1 (E1), Current-Controlled Current Source 1 (F1), Resistor 3 - Lumped Radiation Impedance (R3), and Resistor 4 - Lumped Back Volume Compliance (R4)**.
- 2 Right-click and choose **Copy**.

#### **ELECTRICAL CIRCUIT 2 - TWEETER (CIR2)**

In the **Model Builder** window, under **Component 1 (comp1)** right-click **Electrical Circuit 2 - Tweeter (cir2)** and choose **Paste Multiple Items**.

*Voltage Source 1 (V1)*

- 1 In the **Settings** window for **Voltage Source**, locate the **Node Connections** section.

2 In the table, enter the following settings:

Label	Node names
n	0

*Resistor 1 (R1)*

1 In the **Model Builder** window, click **Resistor 1 (R1)**.

2 In the **Settings** window for **Resistor**, locate the **Node Connections** section.

3 In the table, enter the following settings:

Label	Node names
p	1
n	2

4 Locate the **Device Parameters** section. In the  $R$  text field, type R1\_t.

*Inductor 1 (L1)*

1 In the **Model Builder** window, click **Inductor 1 (L1)**.

2 In the **Settings** window for **Inductor**, locate the **Node Connections** section.

3 In the table, enter the following settings:

Label	Node names
p	2
n	3

4 Locate the **Device Parameters** section. In the  $L$  text field, type L1\_t.

*Current-Controlled Voltage Source 1 (H1)*

1 In the **Model Builder** window, click **Current-Controlled Voltage Source 1 (H1)**.

2 In the **Settings** window for **Current-Controlled Voltage Source**, locate the **Node Connections** section.

3 In the table, enter the following settings:

Label	Node names
p	3
n	0

4 Locate the **Current Measurement** section. From the **Measure current for device** list, choose **Inductor 2 (L2)**.

5 Locate the **Device Parameters** section. In the **Gain** text field, type  $A_t$ .

*Current-Controlled Voltage Source 2 (H2)*

1 In the **Model Builder** window, click **Current-Controlled Voltage Source 2 (H2)**.

2 In the **Settings** window for **Current-Controlled Voltage Source**, locate the **Node Connections** section.

3 In the table, enter the following settings:

Label	Node names
p	6
n	0

4 Locate the **Device Parameters** section. In the **Gain** text field, type  $A_t$ .

*Inductor 2 (L2)*

1 In the **Model Builder** window, click **Inductor 2 (L2)**.

2 In the **Settings** window for **Inductor**, locate the **Node Connections** section.

3 In the table, enter the following settings:

Label	Node names
p	6
n	7

4 Locate the **Device Parameters** section. In the  $L$  text field, type  $L2_t$ .

*Resistor 2 (R2)*

1 In the **Model Builder** window, click **Resistor 2 (R2)**.

2 In the **Settings** window for **Resistor**, locate the **Node Connections** section.

3 In the table, enter the following settings:

Label	Node names
p	7
n	8

4 Locate the **Device Parameters** section. In the  $R$  text field, type  $R2_t$ .

*Capacitor 1 (C1)*

1 In the **Model Builder** window, click **Capacitor 1 (C1)**.

2 In the **Settings** window for **Capacitor**, locate the **Node Connections** section.

3 In the table, enter the following settings:

Label	Node names
p	8
n	9

4 Locate the **Device Parameters** section. In the *C* text field, type  $C1\_t$ .

*External I vs. U I (IvsUI)*

- 1 In the **Model Builder** window, click **External I vs. U I (IvsUI)**.
- 2 In the **Settings** window for **External I vs. U**, locate the **External Device** section.
- 3 From the *V* list, choose **Voltage from lumped speaker boundary (acpr/lspb2)**.
- 4 Locate the **Node Connections** section. In the table, enter the following settings:

Label	Node names
p	9
n	0

*Voltage-Controlled Voltage Source I (EI)*

- 1 In the **Model Builder** window, click **Voltage-Controlled Voltage Source I (EI)**.
- 2 In the **Settings** window for **Voltage-Controlled Voltage Source**, locate the **Node Connections** section.
- 3 In the table, enter the following settings:

Label	Node names
p	9
n	0
measure (+)	11
measure (-)	10

4 Locate the **Device Parameters** section. In the **Gain** text field, type  $Sd\_t[1/m^2]$ .

*Current-Controlled Current Source I (FI)*

- 1 In the **Model Builder** window, click **Current-Controlled Current Source I (FI)**.
- 2 In the **Settings** window for **Current-Controlled Current Source**, locate the **Node Connections** section.

3 In the table, enter the following settings:

Label	Node names
p	10
n	11

4 Locate the **Device Parameters** section. In the **Gain** text field, type  $Sd_t[1/m^2]$ .

*Resistor 3 - Lumped Radiation Impedance (R3)*

1 In the **Model Builder** window, click **Resistor 3 - Lumped Radiation Impedance (R3)**.

2 In the **Settings** window for **Resistor**, locate the **Node Connections** section.

3 In the table, enter the following settings:

Label	Node names
p	10
n	0

4 Locate the **Device Parameters** section. In the  $R$  text field, type  $Zrad\_t*1[ohm*m^4*s/kg]$ .

*Resistor 4 - Lumped Back Volume Compliance (R4)*

1 In the **Model Builder** window, click **Resistor 4 - Lumped Back Volume Compliance (R4)**.

2 In the **Settings** window for **Resistor**, locate the **Node Connections** section.

3 In the table, enter the following settings:

Label	Node names
p	11
n	0

4 Locate the **Device Parameters** section. In the  $R$  text field, type  $Zbv\_t*1[ohm*m^4*s/kg]$ .

Next, create a mesh to study the electrical circuits. Although it is not used by the solver, the acoustic domain still needs to be meshed. The element size therefore does not need to be fine.

## MESH 1 - ELECTRICAL CIRCUITS

1 In the **Model Builder** window, under **Component 1 (comp1)** click **Mesh 1**.

2 In the **Settings** window for **Mesh**, type Mesh 1 - Electrical Circuits in the **Label** text field.

3 Locate the **Physics-Controlled Mesh** section. In the table, clear the **Use** checkboxes for **Geometric Analysis, Detail Size** and **Pressure Acoustics, Frequency Domain (acpr)**.

4 Click  **Build All**.

Proceed with the study to investigate the responses of the midwoofer and tweeter. Remember to disable the coupling with the acoustic domain in this case.

### STUDY 1 - SPEAKER RESPONSES

1 In the **Settings** window for **Study**, type **Study 1 - Speaker Responses** in the **Label** text field.

2 Locate the **Study Settings** section. Clear the **Generate default plots** checkbox.

#### *Step 1: Frequency Domain*

1 In the **Model Builder** window, under **Study 1 - Speaker Responses** click **Step 1: Frequency Domain**.

2 In the **Settings** window for **Frequency Domain**, locate the **Study Settings** section.

3 Click  **Range**.

4 In the **Range** dialog, choose **ISO preferred frequencies** from the **Entry method** list.

5 In the **Start frequency** text field, type 50.

6 In the **Stop frequency** text field, type 10000.

7 From the **Interval** list, choose **1/6 octave**.

8 Click **Replace**.

9 In the **Settings** window for **Frequency Domain**, locate the **Physics and Variables Selection** section.

10 Select the **Modify model configuration for study step** checkbox.

11 In the tree, select **Component 1 (comp1) > Pressure Acoustics, Frequency Domain (acpr)**.

12 Click  **Disable in Solvers**.

13 In the tree, select **Component 1 (comp1) > Electrical Circuit - Midwoofer (cir) > External I vs. U I (IvsUI)**.

14 Click  **Disable**.

15 In the tree, select **Component 1 (comp1) > Electrical Circuit 2 - Tweeter (cir2) > External I vs. U I (IvsUI)**.

16 Click  **Disable**.

17 In the **Study** toolbar, click  **Compute**.

## RESULTS

- 1 In the **Model Builder** window, click **Results**.
- 2 In the **Settings** window for **Results**, locate the **Update of Results** section.
- 3 Select the **Only plot when requested** checkbox.

### *Speaker Responses*

- 1 In the **Results** toolbar, click  **ID Plot Group**.
- 2 In the **Settings** window for **ID Plot Group**, type Speaker Responses in the **Label** text field.
- 3 Click to expand the **Title** section. From the **Title type** list, choose **Label**.
- 4 Locate the **Legend** section. From the **Position** list, choose **Lower right**.

### *Octave Band 1*

- 1 In the **Speaker Responses** toolbar, click  **More Plots** and choose **Octave Band**.
- 2 In the **Settings** window for **Octave Band**, locate the **Selection** section.
- 3 From the **Geometric entity level** list, choose **Global**.
- 4 Locate the **y-Axis Data** section. In the **Expression** text field, type  $\text{acpr.i}\omega\rho_0\text{cir.R3.i}\exp(-i*k_0*1[m]) / (2*\pi*1[m])$ .
- 5 Locate the **Plot** section. From the **Quantity** list, choose **Continuous power spectral density**.
- 6 Click to expand the **Legends** section. Select the **Show legends** checkbox.
- 7 From the **Legends** list, choose **Manual**.
- 8 In the table, enter the following settings:

---

<b>Legends</b>
Midwoofer

### *Octave Band 2*

- 1 Right-click **Octave Band 1** and choose **Duplicate**.
- 2 In the **Settings** window for **Octave Band**, locate the **y-Axis Data** section.
- 3 In the **Expression** text field, type  $\text{acpr.i}\omega\rho_0\text{cir2.R3.i}\exp(-i*k_0*1[m]) / (2*\pi*1[m])$ .
- 4 Locate the **Legends** section. In the table, enter the following settings:

---

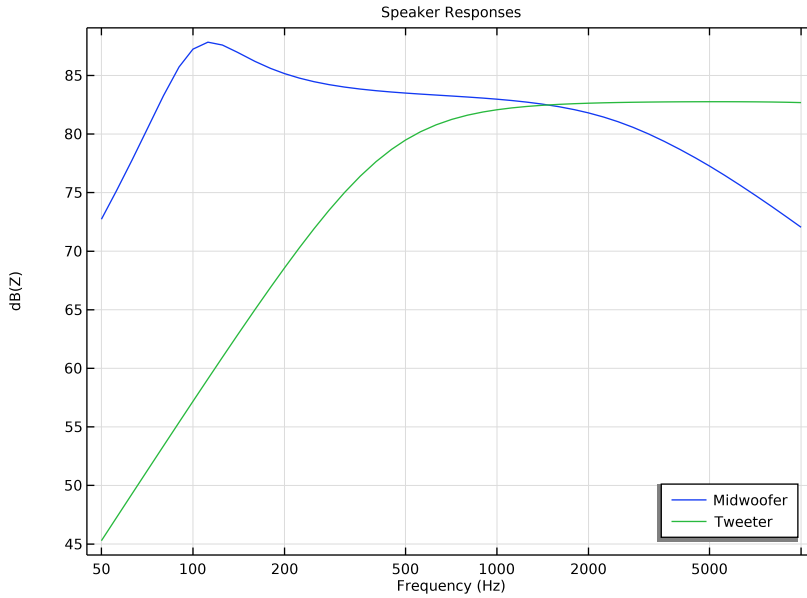

<b>Legends</b>
Tweeter

5 In the **Speaker Responses** toolbar, click  **Plot**.



Now set up the studies and their corresponding meshes to investigate the acoustics of the car cabin.

#### ADD STUDY

- 1 In the **Home** toolbar, click  **Add Study** to open the **Add Study** window.
- 2 Go to the **Add Study** window.
- 3 Find the **Studies** subsection. In the **Select Study** tree, select **More Studies** > **Eigenfrequency**.
- 4 Click the **Add Study** button in the window toolbar.
- 5 In the **Select Study** tree, select **General Studies** > **Frequency Domain**.
- 6 Click the **Add Study** button in the window toolbar three times.
- 7 In the **Home** toolbar, click  **Add Study** to close the **Add Study** window.

#### STUDY 4

##### *Step 1: Frequency Domain*

The second mesh will be used for eigenfrequency search and frequency sweeps. It is built as a fixed mesh based on the highest frequency of the sweep. In general, five to six second-order elements per wavelength are needed to resolve the waves. For more details, see

*Meshing (Resolving the Waves)* in the *Acoustics Module User's Guide*. In this model, use five elements per wavelength. The mesh is also set to avoid generating small elements due to the many small surfaces and edges in the geometry.

#### **MESH 1 - ELECTRICAL CIRCUITS**

In the **Model Builder** window, under **Component 1 (comp1)** right-click **Mesh 1 - Electrical Circuits** and choose **Duplicate**.

#### **MESH 2 - FIXED MESH FOR FREQUENCY SWEEPS**

- 1 In the **Settings** window for **Mesh**, locate the **Physics-Controlled Mesh** section.
- 2 In the table, select the **Use** checkbox for **Pressure Acoustics, Frequency Domain (acpr)**.
- 3 In the **Model Builder** window, click **Mesh 1 - Electrical Circuits 1**.
- 4 In the **Label** text field, type Mesh 2 - Fixed Mesh for Frequency Sweeps.
- 5 Locate the **Pressure Acoustics, Frequency Domain (acpr)** section. From the **Maximum mesh element size control parameter** list, choose **Frequency**.
- 6 Locate the **Sequence Type** section. From the list, choose **User-controlled mesh**.

#### *Size*

- 1 In the **Model Builder** window, under **Component 1 (comp1) > Meshes > Mesh 2 - Fixed Mesh for Frequency Sweeps** click **Size**.
- 2 In the **Settings** window for **Size**, locate the **Element Size Parameters** section.
- 3 In the **Maximum element size** text field, type  $c0/f_{max}/5$ .
- 4 In the **Minimum element size** text field, type 0.06.

#### *Size Expression 1*

In the **Model Builder** window, right-click **Size Expression 1** and choose **Delete**.

#### *Free Tetrahedral 1*

- 1 In the **Settings** window for **Free Tetrahedral**, click to expand the **Element Quality Optimization** section.
- 2 Select the **Avoid elements that are too small** checkbox.

3 Click  **Build All**.

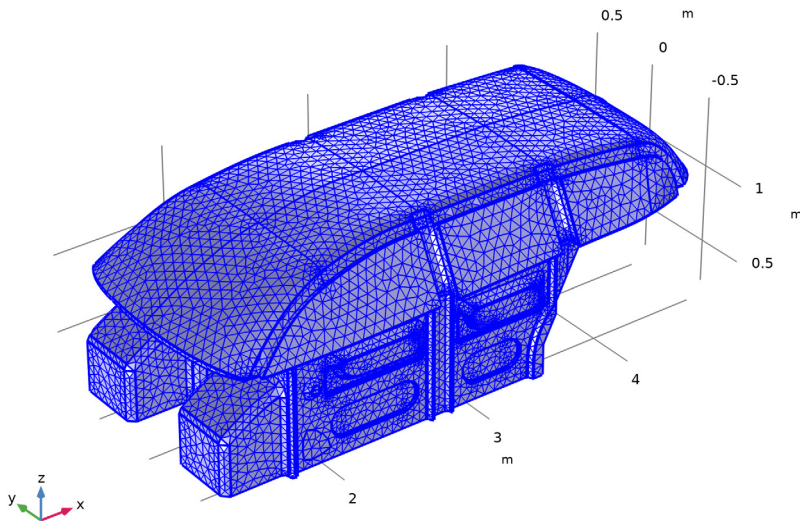

4 In the **Model Builder** window, right-click **Mesh 2 - Fixed Mesh for Frequency Sweeps** and choose **Duplicate**.

### **MESH 3 - ADAPTIVE MESH FOR HIGH FREQUENCIES**

The third mesh will be used to study individual high frequencies. It is set up as an adaptive mesh which will be rebuilt for every frequency value of the parametric sweep.

1 In the **Settings** window for **Mesh**, type **Mesh 3 - Adaptive Mesh for High Frequencies** in the **Label** text field.

#### *Size*

1 In the **Model Builder** window, expand the **Mesh 3 - Adaptive Mesh for High Frequencies** node, then click **Size**.

2 In the **Settings** window for **Size**, locate the **Element Size Parameters** section.

3 In the **Maximum element size** text field, type  $c0/f0/5$ .

Set up and perform the eigenfrequency study. This only depends on the geometry and boundary conditions of the acoustic domain, the electrical circuits should therefore be disabled.

## STUDY 2 - MODAL ANALYSIS

- 1 In the **Model Builder** window, click **Study 2**.
- 2 In the **Settings** window for **Study**, type Study 2 - Modal Analysis in the **Label** text field.

### *Step 1: Eigenfrequency*



- 1 In the **Model Builder** window, under **Study 2 - Modal Analysis** click **Step 1: Eigenfrequency**.
- 2 In the **Settings** window for **Eigenfrequency**, locate the **Study Settings** section.
- 3 From the **Search method around shift** list, choose **Larger real part**.
- 4 Locate the **Physics and Variables Selection** section. In the **Solve for** column of the table, under **Component 1 (comp1)**, clear the checkboxes for **Electrical Circuit - Midwoofer (cir)** and **Electrical Circuit 2 - Tweeter (cir2)**.
- 5 Click to expand the **Mesh Selection** section. In the table, enter the following settings:

Component	Mesh
Component 1	Mesh 2 - Fixed Mesh for Frequency Sweeps

- 6 In the **Study** toolbar, click  **Compute**.

## RESULTS



### *Acoustic Pressure (acpr)*

- 1 In the **Settings** window for **3D Plot Group**, locate the **Data** section.
- 2 From the **Eigenfrequency (Hz)** list, choose **111.13+5.4816i**.
- 3 Click to expand the **Title** section. From the **Title type** list, choose **Manual**.
- 4 In the **Title** text area, type Pressure Eigenmodes.
- 5 In the **Parameter indicator** text field, type Eigenfrequency=eval(freq) Hz.
- 6 In the **Acoustic Pressure (acpr)** toolbar, click  **Plot**.
- 7 Locate the **Data** section. From the **Eigenfrequency (Hz)** list, choose **129.72+1.5727i**.
- 8 In the **Acoustic Pressure (acpr)** toolbar, click  **Plot**.

Loop through the eigenfrequencies to analyze the different modes of the car cabin.

### *Sound Pressure Level (acpr)*

- 1 In the **Model Builder** window, click **Sound Pressure Level (acpr)**.
- 2 In the **Settings** window for **3D Plot Group**, locate the **Data** section.
- 3 From the **Eigenfrequency (Hz)** list, choose **111.13+5.4816i**.

- 4 Locate the **Title** section. From the **Title type** list, choose **Manual**.
- 5 In the **Title** text area, type SPL Eigenmodes.
- 6 In the **Parameter indicator** text field, type Eigenfrequency=eval(freq) Hz.
- 7 In the **Sound Pressure Level (acpr)** toolbar, click  **Plot**.
- 8 Locate the **Data** section. From the **Eigenfrequency (Hz)** list, choose **I29.72+I.5727i**.
- 9 In the **Sound Pressure Level (acpr)** toolbar, click  **Plot**.

Proceed with the studies investigating the car cabin response to loudspeaker excitation. Reduce the data to be stored by limiting it to relevant selections only. In the solver settings, also select the **Block low rank factorization** option to speed up the calculations.

### STUDY 3 - FREQUENCY SWEEP UP TO FMAX

- 1 In the **Model Builder** window, click **Study 3**.
- 2 In the **Settings** window for **Study**, type Study 3 - Frequency Sweep up to fmax in the **Label** text field.
- 3 Locate the **Study Settings** section. Clear the **Generate default plots** checkbox.

#### *Step 1: Frequency Domain*

- 1 In the **Model Builder** window, under **Study 3 - Frequency Sweep up to fmax** click **Step 1: Frequency Domain**.
- 2 In the **Settings** window for **Frequency Domain**, locate the **Study Settings** section.
- 3 Click  **Range**.
- 4 In the **Range** dialog, choose **ISO preferred frequencies** from the **Entry method** list.
- 5 In the **Start frequency** text field, type 50.
- 6 In the **Stop frequency** text field, type fmax.
- 7 From the **Interval** list, choose **1/12 octave**.
- 8 Click **Replace**.
- 9 In the **Settings** window for **Frequency Domain**, locate the **Physics and Variables Selection** section.
- 10 Select the **Modify model configuration for study step** checkbox.
- 11 In the tree, select **Component 1 (comp1) > Electrical Circuit - Midwoofer (cir) > Voltage-Controlled Voltage Source 1 (E1)**, **Component 1 (comp1) > Electrical Circuit - Midwoofer (cir) > Current-Controlled Current Source 1 (F1)**, **Component 1 (comp1) > Electrical Circuit - Midwoofer (cir) > Resistor 3 - Lumped Radiation Impedance (R3)**, and

**Component 1 (comp1) > Electrical Circuit - Midwoofer (cir) > Resistor 4 - Lumped Back Volume Compliance (R4).**

12 Click  **Disable**.

13 In the tree, select **Component 1 (comp1) > Electrical Circuit 2 - Tweeter (cir2) > Voltage-Controlled Voltage Source 1 (E1)**, **Component 1 (comp1) > Electrical Circuit 2 - Tweeter (cir2) > Current-Controlled Current Source 1 (F1)**, **Component 1 (comp1) > Electrical Circuit 2 - Tweeter (cir2) > Resistor 3 - Lumped Radiation Impedance (R3)**, and **Component 1 (comp1) > Electrical Circuit 2 - Tweeter (cir2) > Resistor 4 - Lumped Back Volume Compliance (R4)**.

14 Click  **Disable**.

15 Click to expand the **Store in Output** section. In the table, enter the following settings:

Interface	Output	Selection
Pressure Acoustics, Frequency Domain (acpr)	Selection	

16 Under **Selections**, click  **Add**.

17 In the **Add** dialog, select **Microphone Array** in the **Selections** list.

18 Click **OK**.

19 In the **Settings** window for **Frequency Domain**, click to expand the **Mesh Selection** section.

20 In the table, enter the following settings:

Component	Mesh
Component 1	Mesh 2 - Fixed Mesh for Frequency Sweeps

### *Solution 3 (sol3)*

1 In the **Study** toolbar, click  **Show Default Solver**.

2 In the **Model Builder** window, expand the **Solution 3 (sol3)** node.

3 In the **Model Builder** window, expand the **Study 3 - Frequency Sweep up to fmax > Solver Configurations > Solution 3 (sol3) > Stationary Solver 1** node, then click **Suggested Direct Solver () (Merged)**.

4 In the **Settings** window for **Direct**, locate the **General** section.





5 Select the **Block low rank factorization** checkbox.

### **STUDY 4 - FREQUENCY SWEEP UP TO FMAX (MIDWOOFER ONLY)**

1 In the **Model Builder** window, click **Study 4**.

- 2 In the **Settings** window for **Study**, type Study 4 - Frequency Sweep up to fmax (Midwoofer Only) in the **Label** text field.
- 3 Locate the **Study Settings** section. Clear the **Generate default plots** checkbox.

*Step 1: Frequency Domain*

- 1 In the **Model Builder** window, under **Study 4 - Frequency Sweep up to fmax (Midwoofer Only)** click **Step 1: Frequency Domain**.
- 2 In the **Settings** window for **Frequency Domain**, locate the **Study Settings** section.
- 3 Click  **Range**.
- 4 In the **Range** dialog, choose **ISO preferred frequencies** from the **Entry method** list.
- 5 In the **Start frequency** text field, type 50.
- 6 In the **Stop frequency** text field, type fmax.
- 7 From the **Interval** list, choose **1/12 octave**.
- 8 Click **Replace**.
- 9 In the **Settings** window for **Frequency Domain**, locate the **Physics and Variables Selection** section.
- 10 Select the **Modify model configuration for study step** checkbox.
- 11 In the tree, select **Component 1 (comp1) > Pressure Acoustics, Frequency Domain (acpr) > Lumped Speaker Boundary 2 - Tweeter R**.
- 12 Click  **Disable**.
- 13 In the tree, select **Component 1 (comp1) > Electrical Circuit - Midwoofer (cir) > Voltage-Controlled Voltage Source 1 (E1)**, **Component 1 (comp1) > Electrical Circuit - Midwoofer (cir) > Current-Controlled Current Source 1 (F1)**, **Component 1 (comp1) > Electrical Circuit - Midwoofer (cir) > Resistor 3 - Lumped Radiation Impedance (R3)**, and **Component 1 (comp1) > Electrical Circuit - Midwoofer (cir) > Resistor 4 - Lumped Back Volume Compliance (R4)**.
- 14 Click  **Disable**.
- 15 In the tree, select **Component 1 (comp1) > Electrical Circuit 2 - Tweeter (cir2)**.
- 16 Click  **Disable in Model**.
- 17 Locate the **Store in Output** section. In the table, enter the following settings:

Interface	Output	Selection
Pressure Acoustics, Frequency Domain (acpr)	Selection	

- 18 Under **Selections**, click  **Add**.

- 19 In the **Add** dialog, select **Microphone Array** in the **Selections** list.
- 20 Click **OK**.
- 21 In the **Settings** window for **Frequency Domain**, locate the **Mesh Selection** section.
- 22 In the table, enter the following settings:

Component	Mesh
Component 1	Mesh 2 - Fixed Mesh for Frequency Sweeps

#### *Solution 4 (sol4)*

- 1 In the **Study** toolbar, click  **Show Default Solver**.
- 2 In the **Model Builder** window, expand the **Solution 4 (sol4)** node.
- 3 In the **Model Builder** window, expand the **Study 4 - Frequency Sweep up to fmax (Midwoofer Only) > Solver Configurations > Solution 4 (sol4) > Stationary Solver 1** node, then click **Suggested Direct Solver () (Merged)**.
- 4 In the **Settings** window for **Direct**, locate the **General** section.
- 5 Select the **Block low rank factorization** checkbox.

#### **STUDY 5 - SINGLE FREQUENCIES ABOVE FMAX**

- 1 In the **Model Builder** window, click **Study 5**.
- 2 In the **Settings** window for **Study**, type Study 5 - Single Frequencies Above fmax in the **Label** text field.
- 3 Locate the **Study Settings** section. Clear the **Generate default plots** checkbox.



#### *Parametric Sweep*

- 1 In the **Study** toolbar, click  **Parametric Sweep**.
- 2 In the **Settings** window for **Parametric Sweep**, locate the **Study Settings** section.
- 3 Click **+ Add**.
- 4 In the table, enter the following settings:

Parameter name	Parameter value list	Parameter unit
f0 (Study frequency)	2000, 3000, 4000	Hz

#### *Step 1: Frequency Domain*

- 1 In the **Model Builder** window, click **Step 1: Frequency Domain**.
- 2 In the **Settings** window for **Frequency Domain**, locate the **Study Settings** section.
- 3 In the **Frequencies** text field, type f0.

- 4 Locate the **Physics and Variables Selection** section. Select the **Modify model configuration for study step** checkbox.
- 5 In the tree, select **Component 1 (comp1) > Electrical Circuit - Midwoofer (cir) > Voltage-Controlled Voltage Source 1 (E1)**, **Component 1 (comp1) > Electrical Circuit - Midwoofer (cir) > Current-Controlled Current Source 1 (F1)**, **Component 1 (comp1) > Electrical Circuit - Midwoofer (cir) > Resistor 3 - Lumped Radiation Impedance (R3)**, and **Component 1 (comp1) > Electrical Circuit - Midwoofer (cir) > Resistor 4 - Lumped Back Volume Compliance (R4)**.
- 6 Click  **Disable**.
- 7 In the tree, select **Component 1 (comp1) > Electrical Circuit 2 - Tweeter (cir2) > Voltage-Controlled Voltage Source 1 (E1)**, **Component 1 (comp1) > Electrical Circuit 2 - Tweeter (cir2) > Current-Controlled Current Source 1 (F1)**, **Component 1 (comp1) > Electrical Circuit 2 - Tweeter (cir2) > Resistor 3 - Lumped Radiation Impedance (R3)**, and **Component 1 (comp1) > Electrical Circuit 2 - Tweeter (cir2) > Resistor 4 - Lumped Back Volume Compliance (R4)**.
- 8 Click  **Disable**.
- 9 Locate the **Store in Output** section. In the table, enter the following settings:

Interface	Output	Selection
Pressure Acoustics, Frequency Domain (acpr)	Selection	

- 10 Under **Selections**, click  **Add**.
- 11 In the **Add** dialog, in the **Selections** list, choose **All Boundaries** and **Microphone Array**.
- 12 Click **OK**.
- 13 In the **Settings** window for **Frequency Domain**, locate the **Mesh Selection** section.
- 14 In the table, enter the following settings:

Component	Mesh
Component 1	Mesh 3 - Adaptive Mesh for High Frequencies

Select the iterative solver with Shifted Laplace among the list of suggested solvers to reduce computation time at high frequencies.



*Solution 5 (sol5)*

- 1 In the **Study** toolbar, click  **Show Default Solver**.
- 2 In the **Model Builder** window, expand the **Solution 5 (sol5)** node.

- 3 In the **Model Builder** window, expand the **Study 5 - Single Frequencies Above fmax > Solver Configurations > Solution 5 (sol5) > Stationary Solver 1** node.
- 4 Right-click **Study 5 - Single Frequencies Above fmax > Solver Configurations > Solution 5 (sol5) > Stationary Solver 1 > Suggested Iterative Solver (Shifted Laplace) ()** and choose **Enable**.
- 5 In the **Model Builder** window, expand the **Study 5 - Single Frequencies Above fmax > Solver Configurations > Solution 5 (sol5) > Stationary Solver 1 > Suggested Iterative Solver (Shifted Laplace) () > Multigrid 1 > Coarse Solver** node, then click **Direct**.
- 6 In the **Settings** window for **Direct**, locate the **General** section.
- 7 Select the **Block low rank factorization** checkbox.

Create an overall study to automatically run all the frequency studies one after the other.

#### ADD STUDY

- 1 In the **Home** toolbar, click  **Add Study** to open the **Add Study** window.
- 2 Go to the **Add Study** window.
- 3 Find the **Studies** subsection. In the **Select Study** tree, select **Empty Study**.
- 4 Click the **Add Study** button in the window toolbar.
- 5 In the **Home** toolbar, click  **Add Study** to close the **Add Study** window.

#### STUDY 6 - ALL FREQUENCY ANALYSES

- 1 In the **Settings** window for **Study**, type Study 6 - All Frequency Analyses in the **Label** text field.
- 2 Locate the **Study Settings** section. Clear the **Generate default plots** checkbox.



##### Study 3

- 1 In the **Study** toolbar, click  **Study Reference**.
- 2 In the **Settings** window for **Study Reference**, type Study 3 in the **Label** text field.
- 3 Locate the **Study Reference** section. From the **Study reference** list, choose **Study 3 - Frequency Sweep up to fmax**.

##### Study 4

- 1 In the **Study** toolbar, click  **Study Reference**.
- 2 In the **Settings** window for **Study Reference**, type Study 4 in the **Label** text field.
- 3 Locate the **Study Reference** section. From the **Study reference** list, choose **Study 4 - Frequency Sweep up to fmax (Midwoofer Only)**.

### Study 5

- 1 In the **Study** toolbar, click  **Study Reference**.
- 2 In the **Settings** window for **Study Reference**, type Study 5 in the **Label** text field.
- 3 Locate the **Study Reference** section. From the **Study reference** list, choose **Study 5 - Single Frequencies Above fmax**.
- 4 In the **Study** toolbar, click  **Compute**.

Proceed with the results, starting with the frequency response at the microphone positions and then looking at the SPL on the model's boundary surfaces.

## RESULTS

### Cabin response

- 1 In the **Results** toolbar, click  **ID Plot Group**.
- 2 In the **Settings** window for **ID Plot Group**, type Cabin response in the **Label** text field.
- 3 Locate the **Data** section. From the **Dataset** list, choose **None**.
- 4 Locate the **Title** section. From the **Title type** list, choose **Label**.
- 5 Locate the **Legend** section. From the **Position** list, choose **Lower right**.

### Octave Band 1

- 1 In the **Cabin response** toolbar, click  **More Plots** and choose **Octave Band**.
- 2 In the **Settings** window for **Octave Band**, locate the **Data** section.
- 3 From the **Dataset** list, choose **Study 3 - Frequency Sweep up to fmax/Solution 3 (sol3)**.
- 4 Locate the **Selection** section. From the **Geometric entity level** list, choose **Point**.
- 5 Select Points 543–545 only.
- 6 Locate the **Plot** section. From the **Quantity** list, choose **Continuous power spectral density**.
- 7 Click to expand the **Coloring and Style** section. Find the **Line markers** subsection. From the **Marker** list, choose **Point**.
- 8 Locate the **Legends** section. Select the **Show legends** checkbox.
- 9 From the **Legends** list, choose **Manual**.
- 10 In the table, enter the following settings:

---

#### Legends

---

Study 3

---

## Octave Band 2

- 1 Right-click **Octave Band 1** and choose **Duplicate**.
- 2 In the **Settings** window for **Octave Band**, locate the **Data** section.
- 3 From the **Dataset** list, choose **Study 5 - Single Frequencies Above fmax/ Parametric Solutions 1 (sol7)**.
- 4 Locate the **Coloring and Style** section. Find the **Line style** subsection. From the **Line** list, choose **Dashed**.
- 5 From the **Color** list, choose **Cycle (reset)**.
- 6 Find the **Line markers** subsection. From the **Marker** list, choose **Asterisk**.
- 7 Locate the **Legends** section. In the table, enter the following settings:

---

### Legends

---

Study 5

---

- 8 In the **Cabin response** toolbar, click  **Plot**.

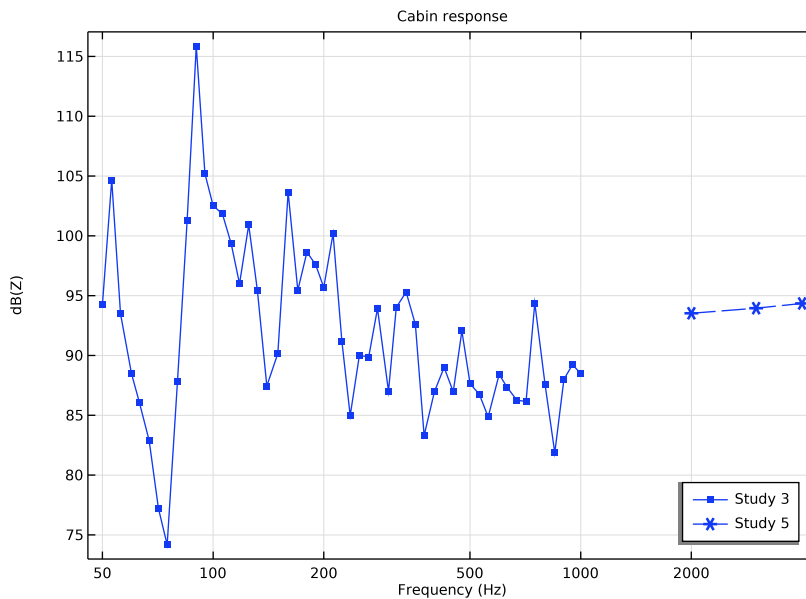

## Cabin Response - Speaker Comparison

- 1 In the **Model Builder** window, right-click **Cabin response** and choose **Duplicate**.
- 2 In the **Model Builder** window, click **Cabin response 1**.

- 3 In the **Settings** window for **ID Plot Group**, type Cabin Response - Speaker Comparison in the **Label** text field.

#### *Octave Band 1*

- 1 In the **Model Builder** window, click **Octave Band 1**.
- 2 In the **Settings** window for **Octave Band**, locate the **Legends** section.
- 3 In the table, enter the following settings:

---

**Legends**

---

Midwoofer and tweeter

---

#### *Octave Band 2*

- 1 In the **Model Builder** window, click **Octave Band 2**.
- 2 In the **Settings** window for **Octave Band**, locate the **Data** section.
- 3 From the **Dataset** list, choose **Study 4 - Frequency Sweep up to fmax (Midwoofer Only)/ Solution 4 (sol4)**.
- 4 Locate the **Coloring and Style** section. From the **Color** list, choose **Cycle**.
- 5 Locate the **Legends** section. In the table, enter the following settings:

---

**Legends**

---



Midwoofer only

---

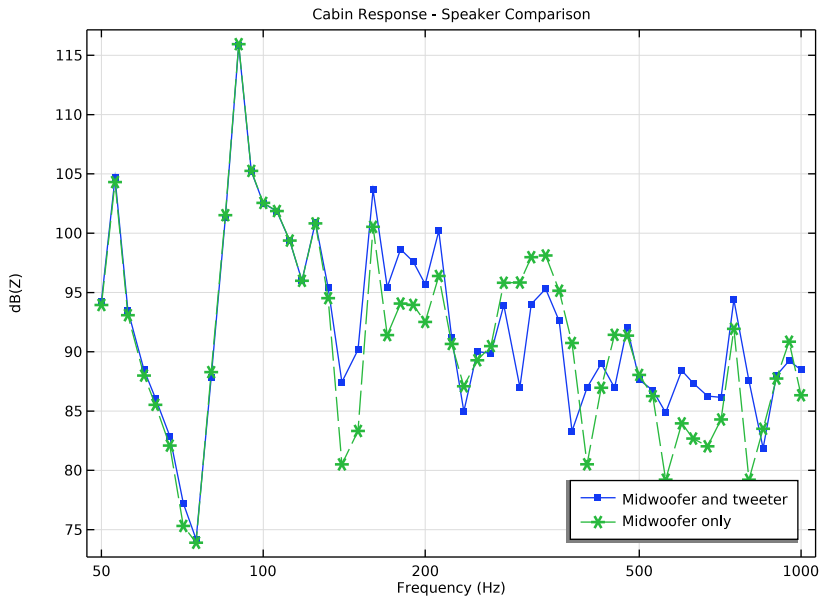
6 In the **Cabin Response - Speaker Comparison** toolbar, click  **Plot**.



## RESULT TEMPLATES

- 1 In the **Results** toolbar, click  **Result Templates** to open the **Result Templates** window.
- 2 Go to the **Result Templates** window.
- 3 In the tree, select **Study 5 - Single Frequencies Above fmax/Parametric Solutions I (sol7) > Pressure Acoustics, Frequency Domain > Sound Pressure Level (acpr)**.
- 4 Click the **Add Result Template** button in the window toolbar.
- 5 In the **Results** toolbar, click  **Result Templates** to close the **Result Templates** window.

## RESULTS

### Surface SPL



To visualize the SPL inside the car, start by selecting all boundaries and then manually remove some roof and window surfaces from the selection.

- 1 In the **Settings** window for **3D Plot Group**, type **Surface SPL** in the **Label** text field.
- 2 Click to expand the **Selection** section. From the **Geometric entity level** list, choose **Boundary**.
- 3 Click  **Paste Selection**.

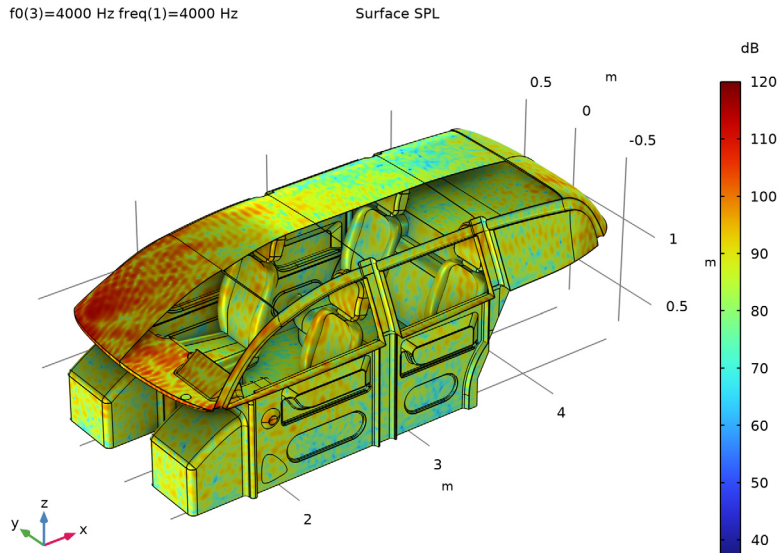
- 4 In the **Paste Selection** dialog, type 1, 2, 4-61, 63-256, 258-476, 478-488, 490-711, 713-808 in the **Selection** text field.
- 5 Click **OK**.
- 6 In the **Settings** window for **3D Plot Group**, locate the **Title** section.
- 7 From the **Title type** list, choose **Label**.
- 8 In the **Surface SPL** toolbar, click  **Plot**.



### *Absorption Coefficients*

- 1 Right-click **Surface SPL** and choose **Duplicate**.  
The absorption coefficient of the boundaries can also be plotted. Choose to display the selection for the seat boundaries and add a few other relevant surfaces.
- 2 In the **Settings** window for **3D Plot Group**, type **Absorption Coefficients** in the **Label** text field.
- 3 Locate the **Data** section. From the **Parameter value (f0 (Hz))** list, choose **2000**.
- 4 Locate the **Selection** section. Click to select the  **Activate Selection** toggle button.
- 5 Click  **Clear Selection**.
- 6 Click  **Paste Selection**.

7 In the **Paste Selection** dialog, type 4, 7, 10, 64, 198, 199, 202, 203, 210, 211, 228, 229, 231-233, 236, 237, 240, 241, 244-247, 258, 269, 275-278, 293, 294, 297-300, 326-335, 340-349, 354, 355, 367, 368, 375, 381-392, 397-414, 417-424, 427-433, 449-455, 465-476, 478, 561, 562, 564, 565, 568-579, 594, 595, 601-607, 641-647, 654, 663, 664, 671, 672, 687, 698-711, 713, 716-738, 747-754, 756-766, 771, 777-796, 798, 799, 804, 805 in the **Selection** text field.

8 Click **OK**.

### Surface 1

1 In the **Model Builder** window, expand the **Absorption Coefficients** node, then click **Surface 1**.

2 In the **Settings** window for **Surface**, locate the **Expression** section.

3 In the **Expression** text field, type `alpha_all`.

4 From the **Unit** list, choose **1**.

5 Click to expand the **Range** section. Select the **Manual color range** checkbox.

6 In the **Minimum** text field, type 0.

7 In the **Maximum** text field, type 1.

8 In the **Absorption Coefficients** toolbar, click  **Plot**.

`f0(1)=2000 Hz freq(1)=2000 Hz`

Absorption Coefficients

