

Battery Design Module

User's Guide

Battery Design Module User's Guide

© 1998–2023 COMSOL

Protected by patents listed on www.comsol.com/patents, or see Help>About COMSOL Multiphysics on the File menu in the COMSOL Desktop for less detailed lists of U.S. Patents that may apply. Patents pending.

This Documentation and the Programs described herein are furnished under the COMSOL Software License Agreement (www.comsol.com/sla) and may be used or copied only under the terms of the license agreement.

COMSOL, the COMSOL logo, COMSOL Multiphysics, COMSOL Desktop, COMSOL Compiler, COMSOL Server, and LiveLink are either registered trademarks or trademarks of COMSOL AB. All other trademarks are the property of their respective owners, and COMSOL AB and its subsidiaries and products are not affiliated with, endorsed by, sponsored by, or supported by those trademark owners. For a list of such trademark owners, see www.comsol.com/trademarks.

Version: COMSOL 6.2

Contact Information

Visit the Contact COMSOL page at www.comsol.com/contact to submit general inquiries or search for an address and phone number. You can also visit the Worldwide Sales Offices page at www.comsol.com/contact/offices for address and contact information.

If you need to contact Support, an online request form is located on the COMSOL Access page at www.comsol.com/support/case. Other useful links include:

- Support Center: www.comsol.com/support
- Product Download: www.comsol.com/product-download
- Product Updates: www.comsol.com/product-update
- COMSOL Blog: www.comsol.com/blogs
- Discussion Forum: www.comsol.com/forum
- Events: www.comsol.com/events
- COMSOL Video Gallery: www.comsol.com/videos
- Support Knowledge Base: www.comsol.com/support/knowledgebase

Part number: CM021501

C o n t e n t s

Chapter 1: Introduction

About the Battery Design Module	26
What Can the Battery Design Module Do?	26
Battery Design Module Physics Interface Guide	27
Common Physics Interface and Feature Settings and Nodes	31
Where Do I Access the Documentation and Application Libraries?	31
Overview of the User's Guide	35

Chapter 2: Modeling with Electrochemistry

Introduction to Electrochemistry Modeling	38
What Is Electrochemistry?	38
Electrochemical Applications	39
Fundamentals of Electrochemistry Modeling	39
Current Distribution Cases and Choosing the Right Interface to Model an Electrochemical Cell	41
Understanding the Different Approximations for Conservation of Charge in Electrolytes	42
Modeling Electrochemical Reactions	46
Double Layer Capacitance	53
Porous Electrodes	54
Boundary Conditions for Running and Controlling Electrochemical Cells	55
Battery Modeling	56
Modeling Cyclic Voltammetry	57
Common Simplifications When Modeling Electrochemical Cells	58
Before You Start Building Your Model.	60
Meshing Advice	61
Solving Electrochemical Models	62
Postprocessing Your Solution	66

Connecting to Electrical Circuits	69
About Connecting Electrical Circuits to Physics Interfaces	69
Connecting Electrical Circuits Using Predefined Couplings	70
Connecting Electrical Circuits by User-Defined Couplings	70
Solving	71
Postprocessing	72
References	72
SPICE Import and Export	73
SPICE Import	73
SPICE Export	74
Reference	75

Chapter 3: Battery Interfaces

The Lithium-Ion Battery Interface	79
About the Domain, Boundary, Edge, Point, and Pair Nodes for the Lithium-Ion Battery Interface	83
Initial Values	83
Electrode Reaction	84
Lithium-Ion Battery, Deformed Geometry Model Wizard Entry	85
Modeling Deformation of an Electrode Surface	86
Tangential Velocities at the Intersection Between a Depositing and a Nondepositing Boundary	86
The Battery with Binary Electrolyte Interface	89
Domain, Boundary, Edge, Point, and Pair Nodes for the Battery with Binary Electrolyte Interface.	93
Initial Values	93
Porous Matrix Adsorption/Desorption Reaction	94
The Lead–Acid Battery Interface	95
Domain, Boundary, Edge, Point, and Pair Nodes for the Lead–Acid Battery Interface.	97

Reservoir.	98
Initial Values	98
Negative Porous Electrode	99
Positive Porous Electrode	99
Separator.	100
The Single Particle Battery Interface	101
Model Tree Nodes for the Single Particle Battery Interface	105
Electrolyte and Separator	105
Positive Electrode	106
Negative Electrode	106
Lithium Insertion Reaction	106
The Lumped Battery Interface	108
Model Tree Nodes for the Lumped Battery Interface	111
Cell Equilibrium Potential.	111
Voltage Losses.	111
Capacity Loss	112
Short Circuit	113
The Battery Equivalent Circuit Model Wizard Entry	114
The Battery Pack Interface	115
Model Tree Nodes for the Battery Pack Interface	116
Batteries	117
Thermal Event.	118
Current Conductors	119
Initial Values	119
Negative Connectors	119
Positive Connectors	119
Shared Nodes for Battery Interfaces	120
Electrolyte	121
Separator.	122
Porous Electrode.	123
Particle Intercalation	125
Porous Electrode Reaction	128
Reaction Source	129

Additional Porous Electrode Material	130
Porous Conductive Binder	130
Concentration	132
No Flux	132
Flux	132
SOC and Initial Charge Distribution	132
Negative Electrode Selection	134
Positive Electrode Selection	134
Theory for the Lithium-Ion Battery Interface	135
References	145
Theory for the Battery with Binary Electrolyte Interface	146
Theory for the Lead–Acid Battery Interface	152
The Electrode Reactions Equations	152
Electrode Kinetics and Active Available Surface Areas	153
Electrode Charge Transport Equations	153
Electrolyte Transport Equations	154
Theory for the Single Particle Battery Interface	158
Theory for the Lumped Battery Interface	165
Theory for the Battery Pack Interface	172

Chapter 4: Electrochemistry Interfaces

The Primary and Secondary Current Distribution Interfaces	176
The Primary Current Distribution and Secondary Current Distribution Interfaces	176
Electrolyte	179
Initial Values	180
Porous Electrode	180
Periodic Condition	182
Thin Electrolyte Layer	182

Edge Electrode	183
Electrode Line Current Source	184
Electrolyte Line Current Source	184
Electrode Symmetry Axis Current Source	184
Electrolyte Symmetry Axis Current Source	185
Electrode Point Current Source	185
Electrolyte Point Current Source	185
Electrode Current	185

The Tertiary Current Distribution, Nernst-Planck Interface 186

The Tertiary Current Distribution, Nernst-Planck Interface	186
Electrolyte	191
Porous Electrode	192
Separator	193
Reactions	193
Initial Values	193
Ion Exchange Membrane	194
Ion Exchange Membrane Boundary	194
Thin Electrolyte Layer	195

Shared Physics Features in the Current Distribution Interfaces

196

Domain, Boundary, Pair, Edge, and Point Nodes for the Electrochemistry Interfaces	196
Current Conductor	198
Highly Conductive Porous Electrode	198
Electrode Current Source	198
Electrolyte Current Source	199
Porous Electrode Reaction	199
Porous Matrix Double-Layer Capacitance	200
Insulation	200
Symmetry	200
Electrode Surface	201
Electrode Reaction	206
Double-Layer Capacitance	211
Perforated Electrode Surface	211
Internal Electrode Surface	212
Electrolyte Potential	212

Electrolyte Current	213
Electrolyte Current Density	213
Thin Electrode Layer	214
Electrode-Electrolyte Boundary Interface	214
Electric Ground	215
Electric Potential	215
Electrode Current Density	216
Electrode Current	216
Electrode Power	217
Harmonic Perturbation	217
Electrode Potential	218
External Short	218
Initial Values for Adsorbing-Desorbing Species	219
Initial Values for Dissolving-Depositing Species	219
Nonfaradaic Reactions	219
Reference Electrode	219
Electric Reference Potential	220
Charge-Discharge Cycling	220
Circuit Terminal	221

The Electrode, Shell Interface **222**

Boundary, Edge, Point, and Pair Nodes for the Electrode, Shell Interface	223
Electrode	224
Initial Values	225
External Current Density	225
Current Source	225
Normal Current Density	226
Electric Insulation	226
Boundary Current Source	226
Ground	226
Electric Potential	227

The Electroanalysis Model Wizard Entry **228**

Theory for the Current Distribution Interfaces **229**

The Nernst–Planck Equations	229
Domain Equations for Primary and Secondary Current Distributions	230

Electrochemical Reactions and the Difference Between a Primary and a Secondary Current Distribution	231
Domain Equations for Tertiary Current Distributions Using the Nernst–Planck Equations and Electroneutrality	234
Mass Fluxes and Sources Due to Electrochemical Reactions	235
Deposition-Dissolution Rates, Growth Velocities, and Thicknesses on an Electrode Surface	236
Stoichiometric Coefficients for Double Layer Capacitive Charging	237
Film Resistance	238
Equilibrium Potentials and the Nernst Equation	238
Electrode Kinetics Expressions	239
Theory for Specific Current Distribution Feature Nodes.	244
Reference	252
Theory for Electrochemical Heat Sources	253
Joule Heating Due to Charge Transport	254
Heating Due to Electrochemical Reactions	254
Heating Due to Heat of Mixing	255
Heat of Mixing in Intercalating Electrodes	256
Total Overpotential Calculation for Concentration Dependent Kinetics	257
References	258
Theory for the Electrode, Shell Interface	259
Governing Equations	259
Coupling to Other Physics Interfaces	259
Theory for Electroanalysis	261
Electroanalytical Methods	261
Supporting Electrolyte	261
Domain Equations for the Electroanalysis Case	262
Electrode Boundary Conditions in the Electroanalysis Model	264
The Electroanalytical Butler–Volmer Equation	266
Counter Electrodes and Overall Charge Balance	267
Electrode Potentials and Reference Electrodes	268
Reference Electrodes	268
Boundary Conditions Using Reference Electrode Potentials.	269
Nodes for Handling Electrode Potentials and Reference Electrodes.	269

Chapter 5: AC/DC Interfaces

The Electrostatics Interface	272
Domain, Boundary, Edge, Point, and Pair Nodes for the Electrostatics Interface	274
Charge Conservation	276
Conduction Loss (Time-Harmonic)	277
Initial Values	278
Space Charge Density	279
Zero Charge	279
Ground	279
Electric Potential	280
Surface Charge Density	280
External Surface Charge Accumulation	281
Symmetry Plane (for Electric Field)	281
Electric Displacement Field	282
Periodic Condition	282
Thin Low Permittivity Gap	284
Line Charge.	284
Line Charge (on Axis)	285
Line Charge (Out-of-Plane)	285
Point Charge	286
Point Charge (on Axis)	287
Change Cross Section	287
Change Thickness (Out-of-Plane).	288
Charge Conservation, Piezoelectric.	288
The Electric Currents Interface	290
Domain, Boundary, Edge, Point, and Pair Nodes for the Electric Currents Interface	292
Current Conservation	294
Initial Values	296
External Current Density	296
Current Source	297
Electric Insulation	297
Boundary Current Source	297
Normal Current Density.	298

Distributed Impedance	298
Contact Impedance	299
Sector Symmetry	300
Line Current Source	302
Line Current Source (on Axis)	302
Point Current Source	302
Point Current Source (on Axis)	303
The Electrical Circuit Interface	304
Ground Node	305
Voltmeter	306
Ampère Meter	306
Resistor	306
Capacitor	307
Inductor	307
Voltage Source	307
Current Source	308
Voltage-Controlled Voltage Source	309
Voltage-Controlled Current Source	310
Current-Controlled Voltage Source	310
Current-Controlled Current Source	310
Switch	311
Subcircuit Definition	312
Subcircuit Instance	312
NPN BJT and PNP BJT	313
n-Channel MOSFET and p-Channel MOSFET	313
Mutual Inductance	314
Transformer	314
Battery Open Circuit Voltage	315
Resistor-Capacitor Couple	315
Diode	316
External I vs. U	316
External U vs. I	317
External I-Terminal	318
SPICE Circuit Import	319
SPICE Circuit Export	319

Theory for the Electrostatics Interface	321
Charge Relaxation Theory	321
Electrostatics Equations	323
The Electrostatics Interface in Time Dependent or Frequency Domain Studies	324
Theory for the Electric Currents Interface	325
Electric Currents Equations in Steady State	325
Theory for the Electrical Circuit Interface	327
Electric Circuit Modeling and the Semiconductor Device Models.	327
Bipolar Transistors	328
MOSFET Transistors	331
Diode	334
Reference for the Electrical Circuit Interface	336

Chapter 6: Chemical Species Transport Interfaces

The Transport of Diluted Species Interface	338
The Transport of Diluted Species in Porous Media Interface	342
Domain, Boundary, and Pair Nodes for the Transport of Diluted Species Interface.	343
Prescribing Conditions on Fluid-Solid Interfaces	346
Species Properties	346
Transport Properties	347
Solid	349
Initial Values	350
Mass-Based Concentrations.	350
Reactions.	351
No Flux	352
Inflow	353
Outflow	353
Concentration.	354
Flux.	354
Symmetry	356
Flux Discontinuity	356

Partition Condition	356
Periodic Condition	357
Line Mass Source	359
Point Mass Source	359
Open Boundary	360
Thin Diffusion Barrier	360
Thin Impermeable Barrier	361
Equilibrium Reaction	361
Surface Reactions	362
Surface Equilibrium Reaction	363
Fast Irreversible Surface Reaction	363
Porous Electrode Coupling	363
Reaction Coefficients	364
Electrode Surface Coupling	365
Porous Medium	365
Fluid	366
Porous Matrix	367
Dispersion	368
Unsaturated Porous Medium	369
Liquid	369
Gas	371
Adsorption	372
Volatilization	374
Species Source	375
Hygroscopic Swelling	375
Out-of-Plane Flux	376
Fracture	378
Fluid (Fracture)	378
Fracture Material	379
The Transport of Diluted Species in Fractures Interface	380
Boundary, Edge, Point, and Pair Nodes for the Transport of Diluted Species in Fractures Interface	382
Adsorption	383
Concentration	385
Dispersion	385
Flux	386
Inflow	386

No Flux	387
Outflow	387
Reactions.	387
Species Source.	388
The Transport of Concentrated Species Interface	390
The Transport of Concentrated Species in Porous Media Interface . . .	396
Domain, Boundary, and Pair Nodes for the Transport of Concentrated Species Interface	397
Prescribing Conditions on Fluid-Solid Interfaces	398
Species Properties	398
Transport Properties	399
Porous Medium	402
Fluid	402
Porous Matrix	406
Electrode Surface Coupling	406
Reaction	407
Reaction Sources.	409
Initial Values	409
Mass Fraction	410
Flux	411
Inflow	412
No Flux	413
Out-of-Plane Flux	413
Outflow	415
Symmetry	416
Flux Discontinuity	416
Open Boundary	417
Equilibrium Reaction	417
Surface Equilibrium Reaction	418
The Chemistry Interface	420
Feature Nodes Available for the Chemistry Interface	425
Reaction	425
Species	431
Electrode Reaction	434
Electrode Reaction Group	436
Reversible Reaction Group	436

Equilibrium Reaction Group	438
Species Group	439
Reaction Thermodynamics	439
Species Activity	439
Species Thermodynamics.	440
The Nernst–Planck–Poisson Equations Interface	441
The Electrophoretic Transport Interface	443
Common Settings for the Species Nodes in the Electrophoretic Transport Interface	446
Diffusion and Migration Settings	448
Domain, Boundary, and Pair Nodes for the Electrophoretic Transport Interface.	449
Solvent	450
Porous Matrix Properties	450
Fully Dissociated Species	450
Uncharged Species	450
Weak Acid	451
Weak Base	451
Ampholyte	451
Protein	452
Current Source	452
Initial Potential.	452
Current	452
Current Density	452
Insulation.	453
Potential	453
Species Source.	453
Initial Concentration	454
Concentration	454
No Flux	454
Flux	454
Inflow	455
Outflow	455
The Surface Reactions Interface	456
Boundary, Edge, Point, and Pair Nodes for the Surface Reactions	

Interface.	457
Surface Properties	458
Initial Values	459
Reactions.	459
Surface Concentration.	460
The Reacting Flow Interfaces	461
The Reacting Laminar Flow Interface	461
The Reacting Flow Coupling Feature	462
Physics Interface Features	466
The Reacting Flow in Porous Media Interfaces	468
The Reacting Flow in Porous Media, Transport of Diluted Species Interface.	468
The Reacting Flow in Porous Media, Transport of Concentrated Species Interface.	469
The Reacting Flow, Diluted Species Coupling Feature	469
The Reacting Flow Coupling Feature	470
Physics Interface Features	470
The Nonisothermal Reacting Flow Multiphysics Interfaces	471
The Nonisothermal Reacting Laminar Flow Interface	471
The Nonisothermal Reacting Turbulent Flow, k - \mathcal{E} Interface.	472
The Nonisothermal Reacting Turbulent Flow, k - ω Interface	473
The Nonisothermal Reacting Turbulent Flow, SST Interface	474
The Nonisothermal Reacting Turbulent Flow, Low Re k - \mathcal{E} Interface	476
The Reacting Flow Coupling Feature	477
Physics Interface Features	477
Theory for the Transport of Diluted Species Interface	479
Mass Balance Equation.	480
Equilibrium Reaction Theory	481
Convective Term Formulation.	483
Solving a Diffusion Equation Only	484
Mass Sources for Species Transport	484
Adding Transport Through Migration	486
Supporting Electrolytes	487
Crosswind Diffusion	488

Danckwerts Inflow Boundary Condition	489
Mass Balance Equation for Transport of Diluted Species in Porous Media	490
Convection in Porous Media	491
Diffusion in Porous Media	493
Dispersion	494
Adsorption	496
Reactions.	498
Mass Transport in Fractures	499
References	500
Theory for the Transport of Concentrated Species Interface	502
Multicomponent Mass Transport	502
Multicomponent Gas Diffusion: Maxwell–Stefan Description	503
Multicomponent Diffusivities	505
Multicomponent Diffusion: Mixture-Averaged Approximation	507
Multispecies Diffusion: Fick’s Law Approximation	510
Multicomponent Thermal Diffusion	511
Regularization of Reaction Rate Expression	512
References for the Transport of Concentrated Species Interface.	512
Theory for the Electrophoretic Transport Interface	513
Theory for the Surface Reactions Interface	519
Governing Equations for the Surface Concentrations	519
Governing Equations for the Bulk Concentrations	520
ODE Formulations for Surface Concentrations	522
Surface Reaction Equations on Deforming Geometries	523
Reference for the Surface Reactions Interface	524
Theory for the Coupling of Mass Transport to Electrochemical Reactions	525
Molar Sources and Sinks	525
Mass Sources and Sinks	526
Theory for the Reacting Flow Interface	527
Pseudo Time Stepping for Mass Transport	527
The Stefan Velocity	527

The Chemical Reaction Rate	529
Nonisothermal Reacting Flow	530
References for the Reacting Flow Interfaces	533

Chapter 7: Fluid Flow Interfaces

The Laminar Flow and Creeping Flow Interfaces	536
The Creeping Flow Interface	536
The Laminar Flow Interface	537
Domain, Boundary, Pair, and Point Nodes for Single-Phase Flow	543
Fluid Properties	543
Volume Force	545
Initial Values	545
Wall	546
Inlet	549
Outlet	553
Symmetry	555
Open Boundary	556
Boundary Stress	557
Periodic Flow Condition	559
Porous Interface	560
Flow Continuity	561
Pressure Point Constraint	562
Point Mass Source	562
Line Mass Source	563
Gravity	564
The Darcy's Law Interface	565
Domain, Boundary, Edge, Point, and Pair Nodes for the Darcy's Law Interface	567
Porous Medium	569
Fluid	571
Porous Matrix	572
Unsaturated Porous Medium	575
Dual Porosity Medium	576
Dual Permeability Medium	577

Unsaturated Dual Permeability Medium	579
Macropores	581
Micropores	582
Mass Source	584
Contributing Velocity	585
Initial Values	586
Gravity	586
Cross Section	587
Thickness.	587
Porous Electrode Coupling	588
Electrode Surface Coupling	588
Pressure	588
Mass Flux.	589
Line Mass Source.	590
Point Mass Source	590
Inlet.	591
Symmetry	592
No Flow	592
Flux Discontinuity	593
Outlet	593
Precipitation	594
Interior Wall	594
Thin Barrier.	594
Pressure Head.	595
Hydraulic Head	595
Atmosphere/Gauge	595
Pervious Layer.	596
Well	597
Fracture	598
Fluid (Fracture)	600
Fracture Material.	601
The Free and Porous Media Flow, Brinkman Interface	603
Domain, Boundary, Point, and Pair Nodes for the Free and Porous Media Flow, Brinkman Interface	605
Fluid Properties	606
Porous Medium	607
Fluid	607

Porous Matrix	608
Mass Source	609
Volume Force	609
Porous Electrode Coupling	610
Initial Values	610
Gravity	610
Electrode-Electrolyte Interface Coupling	611
Wall	611
The Free and Porous Media Flow, Darcy Interface	613
Free and Porous Media Flow Coupling (Multiphysics Coupling)	613
The Brinkman Equations Interface	617
Domain, Boundary, Point, and Pair Nodes for the Brinkman Equations Interface.	620
Porous Medium	621
Fluid	622
Porous Matrix	623
Mass Source	624
Volume Force	625
Initial Values	625
Fluid Properties	625
Gravity	626
Theory for the Laminar Flow and Creeping Flow Interfaces	628
General Single-Phase Flow Theory	629
Compressible Flow	631
Weakly Compressible Flow	631
The Mach Number Limit	631
Incompressible Flow	632
The Reynolds Number.	633
Gravity	634
Theory for the Wall Boundary Condition	635
Prescribing Inlet and Outlet Conditions	639
Mass Flow	641
Fully Developed Flow (Inlet)	642
Fully Developed Flow (Outlet).	644
No Viscous Stress	645

Normal Stress Boundary Condition	645
Pressure Boundary Condition	646
Porous Interface	648
Mass Sources for Fluid Flow	651
Numerical Stability — Stabilization Techniques for Fluid Flow	653
Solvers for Laminar Flow	655
Pseudo Time Stepping for Laminar Flow Models	658
Nitsche Constraints.	659
Particle Tracing in Fluid Flow	659
References for the Single-Phase Flow, Laminar Flow Interfaces	660
Theory for the Darcy's Law Interface	663
About Darcy's Law	663
Darcy's Law — Equation Formulation	664
Storage Models	665
Average Linear Velocity	666
Dual Porosity and Dual Permeability Theory	666
References for the Darcy's Law Interface.	668
Theory for the Free and Porous Media Flow, Brinkman Interface	670
Reference for the Free and Porous Media Flow, Brinkman Interface	670
Theory for the Free and Porous Media Flow, Darcy Interface	671
References	673
Theory for the Brinkman Equations Interface	674
About the Brinkman Equations	674
Brinkman Equations Theory.	674
References for the Brinkman Equations Interface.	676
Theory for the Coupling of Fluid Flow to Electrochemical Reactions	677
Momentum Sources and Sinks	677

Chapter 8: Heat Transfer

Chapter 9: Solid Mechanics

Chapter 10: Thermodynamics

Using Thermodynamic Properties	688
Workflow for Thermodynamics Property Calculations	688
Thermodynamics	690
Thermodynamic System	691
External Thermodynamic Packages	699
External Thermodynamic System	700
Predefined System	703
Exporting and Importing Thermodynamic Systems	706
Species Property	707
Mixture Property	713
Equilibrium Calculation	714
Generate Chemistry	718
Generate Material	720
Coupling with the Reaction Engineering and the Chemistry Interfaces	724
Evaluating a Property Function in a Physics Interface	729
User-Defined Species	729
References	735
Thermodynamic Models and Theory	736
Introduction	736
Thermodynamic Models	736
Selecting the Right Thermodynamic Model	751
Species Property References	752
Thermodynamic Properties Definitions	752
Standard Enthalpy of Formation and Absolute Entropy Terms	756
Reference State	758
Transport Properties	758
Surface Tension	784

References	784
----------------------	-----

Chapter 11: Multiphysics Coupling Nodes

Deforming Electrode Surface	792
Nondeforming Boundary	793
Electrochemical Heating	794
Potential Coupling	794
Space Charge Density Coupling	794

Chapter 12: Parameter Estimation

Chapter 13: Glossary

Glossary of Terms	798
--------------------------	------------

Introduction

This guide describes the Battery Design Module, an optional add-on package for COMSOL Multiphysics® designed to assist you in building detailed models of the configuration of the electrodes, separators, current collectors and other components of battery cells.

This chapter introduces you to the capabilities of the module. A summary of the physics interfaces and where you can find documentation and model examples is also included. The last section is a brief overview with links to each chapter in this guide.

- [About the Battery Design Module](#)
- [Overview of the User's Guide](#)

About the Battery Design Module

In this section:

- [What Can the Battery Design Module Do?](#)
- [Battery Design Module Physics Interface Guide](#)
- [Common Physics Interface and Feature Settings and Nodes](#)
- [Where Do I Access the Documentation and Application Libraries?](#)

What Can the Battery Design Module Do?

The Battery Design Module extends the COMSOL Multiphysics environment with customized physics interfaces for modeling of batteries. These physics interfaces provide tools for building detailed models of the configuration of the various components of a battery. The physics interfaces include descriptions of the electrochemical reactions and the transport properties that influence the performance in terms of charge-discharge characteristics, capacity, heat production and capacity fade. With this module, you have the perfect tools to investigate the influence of using different materials, geometric configurations, and operating conditions.

The core functionality of the module are the electrochemistry interfaces. Generic electrochemistry interfaces for various types (primary, secondary, and tertiary) current distributions are available, which may be used for modeling both solid nonporous as well as for porous electrodes. In addition to these generic electrochemistry interfaces, the module also contains dedicated battery interfaces.

The tailored physics interfaces mentioned above are also complemented with extended functionality in other physics interfaces for chemical species transport, heat transfer, and fluid flow. The extended functionality for heat transfer and fluid flow may be used, for instance, in battery thermal management models.



A selection of suitable materials are also available in the [Battery Material Library](#). For more detailed information about materials, see [Materials](#) in the *COMSOL Multiphysics Reference Manual*.

Finally, the Application Library available with Battery Design Module includes various tutorials (model examples), for a multitude of different battery chemistries such as:

- Lithium-ion (Li-ion) batteries
- Lead–Acid batteries
- Nickel–metal hydride (NiMH) batteries
- Vanadium redox flow batteries
- Soluble lead–acid flow batteries

See [Where Do I Access the Documentation and Application Libraries?](#) to locate and use these examples and tutorials as a starting point to your own investigations.

Battery Design Module Physics Interface Guide













The table lists the physics interfaces available with this module in addition to the core physics included with COMSOL Multiphysics.





















In the *COMSOL Multiphysics Reference Manual*:



- [Studies and Solvers](#)
- [The Physics Interfaces](#)
- For a list of all the core physics interfaces included with a COMSOL Multiphysics license, see [Physics Interface Guide](#).

PHYSICS INTERFACE	ICON	TAG	SPACE DIMENSION	AVAILABLE STUDY TYPE
Chemical Species Transport				
Transport of Diluted Species		tds	all dimensions	stationary; time dependent
Transport of Concentrated Species		tcs	all dimensions	stationary; time dependent
Chemistry		chem	all dimensions	stationary; time dependent
Nernst–Planck–Poisson Equations		tds+es	all dimensions	stationary; time dependent; stationary source sweep; small-signal analysis, frequency domain

PHYSICS INTERFACE	ICON	TAG	SPACE DIMENSION	AVAILABLE STUDY TYPE
Electrophoretic Transport		el	all dimensions	stationary; stationary with initialization; time dependent; time dependent with initialization
Transport of Diluted Species in Porous Media		tds	all dimensions	stationary; time dependent
Transport of Concentrated Species in Porous Media		tcs	all dimensions	stationary; time dependent
Surface Reactions		sr	all dimensions	stationary (3D, 2D, and 2D axisymmetric models only); time dependent
Transport of Diluted Species in Fractures		dsf	3D, 2D, 2D axisymmetric	stationary; time dependent
 Reacting Flow				
Laminar Flow		—	3D, 2D, 2D axisymmetric	stationary; time dependent
Laminar Flow, Diluted Species		—	3D, 2D, 2D axisymmetric	stationary; time dependent
 Nonisothermal Reacting Flow				
Laminar Flow		—	3D, 2D, 2D axisymmetric	stationary; time dependent
 Reacting Flow in Porous Media				
Transport of Diluted Species		—	3D, 2D, 2D axisymmetric	stationary; time dependent
Transport of Concentrated Species		—	3D, 2D, 2D axisymmetric	stationary; time dependent

PHYSICS INTERFACE	ICON	TAG	SPACE DIMENSION	AVAILABLE STUDY TYPE
 Electrochemistry				
Primary Current Distribution		cd	all dimensions	stationary; stationary with initialization; time dependent; time dependent with initialization; AC impedance, initial values; AC impedance, stationary; AC impedance, time dependent
Secondary Current Distribution				
Tertiary Current Distribution, Nernst–Planck (Electroneutrality, Water-Based with Electroneutrality, Supporting Electrolyte)		tcd	all dimensions	stationary; stationary with initialization; time dependent; time dependent with initialization; AC impedance, initial values; AC impedance, stationary; AC impedance, time dependent
Electroanalysis		tcd	all dimensions	stationary; time dependent; AC impedance, initial values; AC impedance, stationary; AC impedance, time dependent; cyclic voltammetry
Electrode, Shell		els	3D, 2D, 2D axisymmetric	stationary; time dependent
 Battery Interfaces				
Lithium-Ion Battery (Binary 1:1 Liquid Electrolyte, Single-Ion Conductor)		liion	all dimensions	stationary; time dependent; AC impedance, initial values; AC impedance, stationary; AC impedance, time dependent
Battery with Binary Electrolyte		batbe	all dimensions	stationary; time dependent; AC impedance, initial values; AC impedance, stationary; AC impedance, time dependent

PHYSICS INTERFACE	ICON	TAG	SPACE DIMENSION	AVAILABLE STUDY TYPE
Lead–Acid Battery		leadbat	all dimensions	stationary; time dependent; AC impedance, initial values; AC impedance, stationary; AC impedance, time dependent
Single Particle Battery		spb	all dimensions	time dependent; time dependent with initialization
Lumped Battery		lb	all dimensions	time dependent; AC impedance, initial values;
Battery Equivalent Circuit		ec	Not space dependent	stationary; time dependent; frequency domain
Battery Pack		bp	3D	time dependent
Fluid Flow				
Porous Media and Subsurface Flow				
Brinkman Equations		br	3D, 2D, 2D axisymmetric	stationary; time dependent
Darcy's Law		dl	all dimensions	stationary; time dependent
Free and Porous Media Flow, Brinkman		fp	3D, 2D, 2D axisymmetric	stationary; time dependent
Free and Porous Media Flow, Darcy		—	3D, 2D, 2D axisymmetric	stationary; time dependent
Nonisothermal Flow				
Brinkman Equations		—	3D, 2D, 2D axisymmetric	stationary; time dependent; stationary, one-way NITF; time dependent, one-way NITF

PHYSICS INTERFACE	ICON	TAG	SPACE DIMENSION	AVAILABLE STUDY TYPE
 Heat Transfer				
Heat Transfer in Porous Media		ht	all dimensions	stationary; time dependent

Common Physics Interface and Feature Settings and Nodes

There are several common settings and sections available for the physics interfaces and feature nodes. Some of these sections also have similar settings or are implemented in the same way no matter the physics interface or feature being used. There are also some physics feature nodes that display in COMSOL Multiphysics.

In each module's documentation, only unique or extra information is included; standard information and procedures are centralized in the *COMSOL Multiphysics Reference Manual*.



In the *COMSOL Multiphysics Reference Manual* see [Table 2-4](#) for links to common sections and [Table 2-5](#) to common feature nodes. You can also search for information: press F1 to open the **Help** window or Ctrl+F1 to open the **Documentation** window.

Where Do I Access the Documentation and Application Libraries?

A number of online resources have more information about COMSOL, including licensing and technical information. The electronic documentation, topic-based (or context-based) help, and the Application Libraries are all accessed through the COMSOL Desktop.





If you are reading the documentation as a PDF file on your computer, the [blue links](#) do not work to open an application or content referenced in a different guide. However, if you are using the Help system in COMSOL Multiphysics, these links work to open other modules, application examples, and documentation sets.

THE DOCUMENTATION AND ONLINE HELP

The *COMSOL Multiphysics Reference Manual* describes the core physics interfaces and functionality included with the COMSOL Multiphysics license. This book also has instructions on how to use COMSOL Multiphysics and how to access the electronic Documentation and Help content.

Opening Topic-Based Help

The Help window is useful as it is connected to the features in the COMSOL Desktop. To learn more about a node in the Model Builder, or a window on the Desktop, click to highlight a node or window, then press F1 to open the Help window, which then displays information about that feature (or click a node in the Model Builder followed by the **Help** button (). This is called *topic-based* (or *context*) *help*.

Win	<p>To open the Help window:</p> <ul style="list-style-type: none">• In the Model Builder, Application Builder, or Physics Builder, click a node or window and then press F1.• On any toolbar (for example, Home, Definitions, or Geometry), hover the mouse over a button (for example, Add Physics or Build All) and then press F1.• From the File menu, click Help ().• In the upper-right corner of the COMSOL Desktop, click the Help () button.
-----	---

Opening the Documentation Window

Win	<p>To open the Documentation window:</p> <ul style="list-style-type: none">• Press Ctrl+F1.• From the File menu, select Help>Documentation ().
-----	--

THE APPLICATION LIBRARIES WINDOW

Each model or application includes documentation with the theoretical background and step-by-step instructions to create a model or application. The models and applications are available in COMSOL Multiphysics as MPH-files that you can open for further investigation. You can use the step-by-step instructions and the actual models as templates for your own modeling. In most models, SI units are used to

describe the relevant properties, parameters, and dimensions, but other unit systems are available.

Once the Application Libraries window is opened, you can search by name or browse under a module folder name. Click to view a summary of the model or application and its properties, including options to open it or its associated PDF document.



[The Application Libraries Window](#) in the *COMSOL Multiphysics Reference Manual*.

Opening the Application Libraries Window

To open the **Application Libraries** window ():

Win

From the **File** menu, select **Application Libraries**.

To include the latest versions of model examples, from the **File>Help** menu select () **Update COMSOL Application Libraries**.

Mac

From the **File** or **Windows** menu, select **Application Libraries**.

Linux

To include the latest versions of model examples, from the **Help** menu select () **Update COMSOL Application Libraries**.

CONTACTING COMSOL BY EMAIL

For general product information, contact COMSOL at info@comsol.com.

COMSOL ACCESS AND TECHNICAL SUPPORT

To receive technical support from COMSOL for the COMSOL products, please contact your local COMSOL representative or send your questions to support@comsol.com. An automatic notification and a case number will be sent to you by email. You can also access technical support, software updates, license information, and other resources by registering for a COMSOL Access account.

COMSOL ONLINE RESOURCES

COMSOL website	www.comsol.com
Contact COMSOL	www.comsol.com/contact
COMSOL Access	www.comsol.com/access
Support Center	www.comsol.com/support
Product Download	www.comsol.com/product-download
Product Updates	www.comsol.com/product-update
COMSOL Blog	www.comsol.com/blogs
Discussion Forum	www.comsol.com/forum
Events	www.comsol.com/events
COMSOL Application Gallery	www.comsol.com/models
COMSOL Video Gallery	www.comsol.com/videos
Support Knowledge Base	www.comsol.com/support/knowledgebase

Overview of the User's Guide

The *Battery Design Module User's Guide* gets you started with modeling using COMSOL Multiphysics. The information in this guide is specific to this module. Instructions how to use COMSOL in general are included with the *COMSOL Multiphysics Reference Manual*.



As detailed in the section [Where Do I Access the Documentation and Application Libraries?](#) this information can also be searched from the COMSOL Multiphysics software **Help** menu.

TABLE OF CONTENTS, GLOSSARY, AND INDEX

To help you navigate through this guide, see the [Contents](#), [Glossary of Terms](#), and [Index](#).

MODELING WITH ELECTROCHEMISTRY

The [Modeling with Electrochemistry](#) chapter discusses a variety of topics, including [Fundamentals of Electrochemistry Modeling](#), [Modeling Electrochemical Reactions](#), [Modeling Cyclic Voltammetry](#), and [Postprocessing Your Solution](#).

THE BATTERY INTERFACES

The [Battery Interfaces](#) chapter describes the Battery with Binary Electrolyte, Lead-Acid Battery, and Lumped Battery, the Single-Particle Battery and the Lithium-Ion Battery interfaces. Also the Battery Equivalent Circuit model wizard entry is described in this chapter.

THE ELECTROCHEMISTRY INTERFACES

The [Electrochemistry Interfaces](#) chapter describes the Primary Current Distribution, Secondary Current Distribution, Tertiary Current Distribution, Nernst-Planck, Electrode, Shell, and Electroanalysis interfaces.

THE AC/DC INTERFACES

The [AC/DC Interfaces](#) chapter describes the Electrostatics, the Electrical Currents and the Electrical Circuit interfaces.

THE CHEMICAL SPECIES TRANSPORT INTERFACES

The [Chemical Species Transport Interfaces](#) chapter describes the Transport of Diluted Species, Transport of Concentrated Species, the Transport of Diluted Species in Porous Media, the Surface Reaction and the Reacting Flow interfaces.

THE FLUID FLOW INTERFACES

The [Fluid Flow Interfaces](#) chapter describes the Darcy's Law and Free and Porous Media Flow interfaces, both included under the Porous Media and Subsurface Flow branch.

The Laminar Flow interface is also available and is described in the *COMSOL Multiphysics Reference Manual*.

HEAT TRANSFER

The [Heat Transfer](#) chapter describes how electrochemical heat sources can be coupled to heat transfer, and the theory for how these are calculated.

SOLID MECHANICS

The [Solid Mechanics](#) chapter describes functionality added by the Battery Design Module to the Solid Mechanics interface.

THERMODYNAMICS

This chapter describes the functionality of the [Thermodynamics](#) node to define thermo-physical and transport properties.

THE MULTIPHYSICS COUPLING NODES

The [Multiphysics Coupling Nodes](#) chapter describes the coupling nodes available under the Multiphysics node for coupling various electrochemical interfaces using flow, potential, and temperature couplings, for example.

Modeling with Electrochemistry

In this chapter:

- [Introduction to Electrochemistry Modeling](#)
- [Connecting to Electrical Circuits](#)
- [SPICE Import and Export](#)

Introduction to Electrochemistry Modeling

In this section:

- [What Is Electrochemistry?](#)
- [Electrochemical Applications](#)
- [Fundamentals of Electrochemistry Modeling](#)
- [Current Distribution Cases and Choosing the Right Interface to Model an Electrochemical Cell](#)
- [Understanding the Different Approximations for Conservation of Charge in Electrolytes](#)
- [Modeling Electrochemical Reactions](#)
- [Double Layer Capacitance](#)
- [Porous Electrodes](#)
- [Boundary Conditions for Running and Controlling Electrochemical Cells](#)
- [Battery Modeling](#)
- [Modeling Cyclic Voltammetry](#)
- [Common Simplifications When Modeling Electrochemical Cells](#)
- [Before You Start Building Your Model](#)
- [Meshing Advice](#)
- [Solving Electrochemical Models](#)
- [Postprocessing Your Solution](#)

What Is Electrochemistry?

An *electrochemical* process is one that either converts electrical energy to chemical energy or converts chemical energy to electrical energy.

In electrochemical reactions, chemicals react by gaining or losing electrons. Chemicals can exchange these electrons with an electrical conductor or circuit. The chemical potential — or thermodynamic driving force — for a chemical reaction is thus converted into an electrical potential or voltage, which can be exploited to do useful work when an electrical current is drawn.

Electrochemical Applications

Electrochemical systems may be classified in different ways.

One approach is to contrast those electrochemical systems involving desirable reactions from those involving undesirable reactions. Synthetic *electrolysis* is an example of a desirable reaction because the chemical process is promoted to generate a desired product. Or, for example, when designing a battery we might want to set up conditions to promote an electrochemical reaction in order to extract useful energy.

Corrosion is an example of undesirable electrochemistry because in this case spontaneous electrochemical reactions destroy structural materials and so harm the integrity of a system: we aim to minimize the rate of these reactions.

Electrochemical systems can also be classified into systems that output energy or systems that consume energy. *Batteries and fuel cells* are energy extraction devices — an electrochemical reaction is used to convert the energy in chemical system into a voltage. Such cells are also called *galvanic cells*. By contrast, in *electrolysis*, the system consumes energy to promote an electrochemical reaction for synthesis. Similar electrochemical systems needing energy input include manufacturing processes such as *electroplating*. Electrochemical reactions may also be driven for *electroanalysis*, to quantify or otherwise explore the chemical constituents or reactivity of a system.

The different electrochemical modules in COMSOL Multiphysics are designed to offer tailored physics interfaces provision for each of these electrochemical situations. The underlying physical description provided by the general physics interfaces described below is common to all the modules — the differences between the modules lies in the particular expected system inputs and outputs and the intended behavior of the system.

Fundamentals of Electrochemistry Modeling

Electrochemical systems consist of electrically conducting media. These may be classified as electrodes or electrolytes. An *electrode* carries current by transport of electrons; normally the electrode is a conventional electrical conductor such as a metal. The *electrolyte* carries current by transport of charged chemical species (ions). Electrolytes are often salt solutions in water but may include salt solutions in other liquid solvents, as well as solids, such as concrete, which can conduct by transport of oxide ions. The electrical conductivity of an electrode is normally several orders of magnitude larger than the electrical conductivity of an electrolyte.

THE ELECTRODE-ELECTROLYTE INTERFACE

At the *electrode-electrolyte interface*, conventional electrical current in the electrode is converted into ionic current in the electrolyte. According to the overall conservation of charge, these currents must balance here. The conversion between the two types of currents may arise due to electrochemical reaction (electrolysis) or capacitive charging.

Electrolysis occurs when a chemical species in the electrolyte exchanges one or more electrons with the electrode. Capacitive charging occurs when the potential of an electrode is changing, so that ions in the electrolyte are either attracted or repelled from the surface, drawing a current.

Batteries and fuel cells can also involve porous electrodes, in which an electrode material has a micro- or nanostructure that is permeable to an electrolyte solution. The advantage of such a material is the great increase in the area of the electrode-electrolyte interface.

Note that all current must move in circuits. An isolated electrode-electrolyte interface cannot draw a net current, but a system with two such interfaces can. An electrochemical system with two or more electrodes in contact with electrolyte is called an *electrochemical cell*.

In an electrochemical cell with two electrodes, these electrodes are identified as an *anode*, at which the electrochemical reaction transfers electrons from electrolyte to electrode, and a *cathode*, at which electrons are transferred from the electrode to the electrolyte. Note that it is the direction of the current that will determine if an electrode reaction is anodic or cathodic. For a battery, for instance, the location of the anode and cathode will change depending on whether the battery is charged or discharged. (The general habit in the battery community to always denounce the positive electrode as the “cathode” is hence strictly only correct during battery discharge.)

Conventional electric current is the flow of positive charge, which is then from anode to cathode through the electrolyte. A closed circuit, conserving overall system charge, is formed by the flow of electric current in the electrode domains (and any electrical circuitry) from cathode to anode, and by the transport of ions through the electrolyte domains from anode to cathode.

OUTPUTS OF INTEREST FROM A MODEL

The experimentally measurable features of an electrochemical system are the external (lumped) current and voltage acting between the two electrodes. It is, in general, impossible to measure local current densities or potentials at different points on the

surface of a conducting electrode, or at arbitrary points within an electrochemical system.

The advantage of physical modeling is the ability to investigate the full space-dependent behavior of the system under a wide range of circumstances to identify the reasons for the observed current-voltage relationship, and so to identify the appropriate physical conditions to optimize current and voltage as required.

The overall current-voltage curve of an electrochemical cell is also known as a *polarization curve* or, in an analytical context, a *voltammogram*. These curves are not unique but rather depend on the means by which the current or voltage is altered, since these lumped parameters are related to multiple physical effects with different length and time scales. Hysteresis in practical polarization curves is not uncommon.

Polarization curves are frequently nonlinear. The combination of nonlinearity and hysteresis means that electrochemical cells do not necessarily resemble “ideal” electrical components (such as a circuit of resistors and capacitors) in the sense of giving a predictable and linear current-voltage response.



- [Potential Variables](#)
- [Current Variables and Calculating the Total Cell Current](#)

Current Distribution Cases and Choosing the Right Interface to Model an Electrochemical Cell

COMSOL Multiphysics has many built-in physics interfaces aimed at specific applications. In many generic cases, however, the modeler has to make some basic assumptions about his system before starting to build his model.

Under the assumption of a linear relation of current density to electric field, Ohm’s law is obeyed for the electrolyte current. This is the assumption of *primary current distribution*, where one also assumes infinitely fast electrodes kinetics, resulting in negligible potential drops over the electrode-electrolyte interfaces. If the electrode reaction kinetics proceed at a finite rate, then the system has a *secondary current distribution*. In cases where more advanced nonlinear charge conservation equations and concentration-dependent electrode polarization are required, the system is described as obeying *tertiary current distribution*.

In some applications, especially within the field of *electroanalysis*, the potential gradients in the electrolyte are so small that the spatial distribution of current in the

electrolyte is not solved for. Such models are instead centered around the interplay of electrode kinetics and transport (by diffusion) of the reacting species in the vicinity of the electrode.

A rule-of-thumb flowchart for selecting a proper current distribution interface for a model is shown below. The recommendations here are indicative and the modeler may sometimes want to deviate from the suggested route; in particular, simpler descriptions are recommended at an earlier stage of model development. In the following sections we explain some of the theory behind this flowchart with regards to the description of the electrolyte charge transport and electrode reactions.

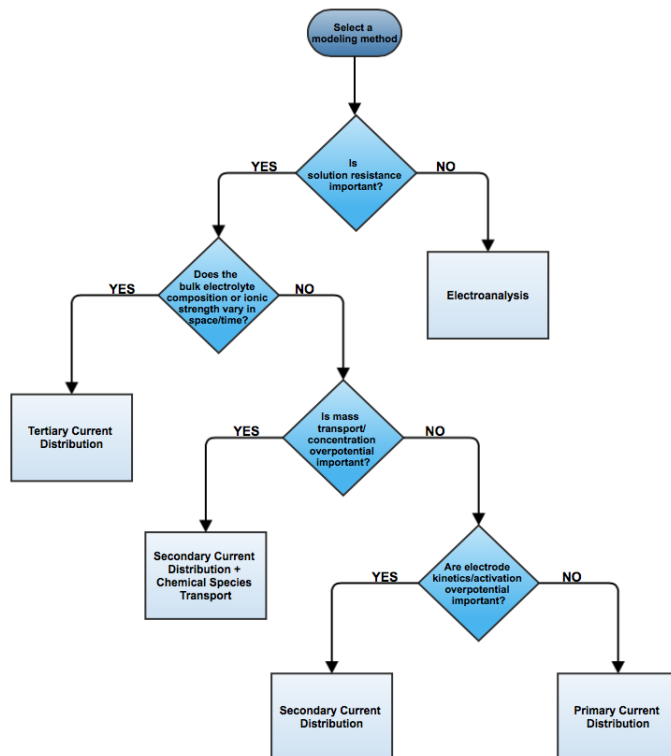

Understanding the Different Approximations for Conservation of Charge in Electrolytes

Deciding how to model the charge transport in the electrolyte is usually the starting point when setting up an electrochemical model since this will determine what physics

interface you will use when starting to build your model. Different theoretical descriptions of the electrolyte current density are included in COMSOL Multiphysics. They are applicable in different circumstances as discussed in this section.

The electric displacement field in a medium is related to the local charge density according to Gauss's law, one of Maxwell's equations:

$$\nabla \cdot \mathbf{D} = \rho_v$$

In electrolytes, we can normally assume that the electrical permittivity is constant and equal to a bulk value:

$$\mathbf{D} = \varepsilon_0 \varepsilon_s \mathbf{E} = -\varepsilon_0 \varepsilon_s \nabla V$$

Hence

$$\nabla^2 V + \frac{\rho_v}{\varepsilon_0 \varepsilon_s} = 0$$

In an electrolyte with ionic charge carriers, the charge density can be written as:

$$\rho_v = F \sum_i z_i c_i$$

Hence

$$\nabla^2 V + \frac{F}{\varepsilon_0 \varepsilon_s} \sum_i z_i c_i = 0$$

This is the *Poisson equation* relating the electrolyte potential to the distribution of charge carriers within the electrolyte. In its derivation we assumed that the only charge carriers are ions, and that the solvated ions and electric field do not alter the permittivity of the medium.

The mass transport of the charge carriers in aqueous systems is normally given by the *Nernst-Planck equations*. These equations neglect ion-ion interactions, and so they are only exact for infinitely dilute solutions:

$$\mathbf{N}_i = -D_i \nabla c_i - z_i u_{m,i} F c_i \nabla \phi_l + c_i \mathbf{u}$$

Note that concentrated electrolyte systems, such as those in many batteries, use an extended concentrated species flux definition, based on the Maxwell-Stefan set of

equations. This will result in a different set of equations to solve for, but the general principles and conclusion in this section will be the same.

Substituting the Nernst–Einstein relation for the electrical mobility of an ion we get:

$$\mathbf{N}_i = -D_i \left(\nabla c_i + \frac{z_i F}{RT} c_i \nabla \phi_l \right) + c_i \mathbf{u}$$

The above expressions for the n species i , together with the Poisson equation, give a set of $n + 1$ equations in $n + 1$ unknowns. These are the *Nernst–Planck–Poisson equations*. They can be defined in COMSOL Multiphysics by coupling **Transport of Diluted Species** with **Electrostatics**, or by using the **Tertiary Current Distribution, Nernst–Planck** interface with **Charge conservation model: Poisson**, but they are highly nonlinear and difficult to converge. Most often, further approximations can simplify the problem without compromising accuracy.



- [Theory for the Transport of Diluted Species Interface](#)
- [Theory of Electrostatics](#) in the *COMSOL Multiphysics Reference Manual*

An important dimensional quantity occurring in the Poisson equation is:

$$x_D = \sqrt{\frac{RT \varepsilon_0 \varepsilon_s}{F^2 I}}$$

This is the length across which electric fields are screened. It is called the *Debye length*. This is a very short length in electrolyte solutions: for a typical ionic strength, it is of the order of 1 nm. *Electroneutrality* holds at distances much larger than 1 nm from a charged surface:

$$\sum z_i c_i = 0$$

The constraint of electroneutrality can be used as a condition to determine the electric potential in the Nernst–Planck equations, in place of the full Poisson equation. The

Nernst–Planck equations with electroneutrality are used to describe current flow in the **Tertiary Current Distribution, Nernst-Planck** interface.



The Tertiary Current Distribution, Nernst-Planck Interface

The current flow itself is given by

$$\mathbf{i}_l = F \sum z_i \mathbf{N}_i$$

From substitution of the Nernst–Planck expressions for \mathbf{N}_i , the laws of conservation of mass and charge combine to automatically satisfy conservation of current.

We can simplify the system further by considering the arising expression for \mathbf{i}_l in more detail:

$$\mathbf{i}_l = -F \sum D_i z_i \nabla c_i - \frac{F^2}{RT} \nabla \phi_l \sum z_i^2 D_i c_i + \mathbf{u} \sum z_i c_i$$

Clearly, the rightmost term is zero: that is, convection of an electroneutral solution does not cause current flow. The leftmost term (diffusion current) also vanishes due to electroneutrality if the gradients of the charge carrying species are zero.

Even if this is not the case, however, this term is often much smaller than the central term (migration current), so long as the concentrations of the current-carrying ions do not vary markedly through the solution. Under conditions where the composition of the electrolyte can be considered nearly constant and current-carrying ions are not significantly depleted, the diffusion current can be assumed to contribute negligibly.

Hence, it follows that

$$\mathbf{i}_l = -\sigma_l \nabla \phi_l$$

This expression for current density is used in the **Secondary Current Distribution** interface, and also the **Primary Current Distribution** interface. The difference between these interfaces lies in the treatment of the electrode-electrolyte interfaces (see [Kinetics of Electrochemical Reactions](#) below). From the above, the conductivity of the electrolyte σ_l is given as:

$$\sigma_l = \frac{F^2}{RT} \sum z_i^2 D_i c_i$$

So long as this quantity does not vary markedly through the solution, the approximation of zero diffusion current is good. If the diffusivities and concentrations can be taken as constant, we can approximate that:

$$\sigma_l \approx \frac{2F^2 ID_{\text{mean}}}{RT}$$

The advantage of the ohmic expression for current density is that it is a linear relation of current density to electrolyte potential. It is only weakly nonlinear if σ_l is allowed to depend on a concentration solved for in a species transport interface. By comparison, the Nernst–Planck equations with electroneutrality can be highly nonlinear.

The approximations used to derive the secondary current distribution expression place tighter constraints on the allowed system configurations, however. The ionic strength of the solution must remain near-constant for the constant conductivity approximation to be valid. Usually this is only the case for relatively high conductivity solutions.

When the conductivity is large with respect to the current drawn, the electric field becomes negligible in solution. For negligible electric fields, a diffusion-only approximation may be used, where $\mathbf{E} = \mathbf{0}$. This converts the Nernst–Planck equations into Fick’s laws, with a term for convective transport where necessary. Fick’s laws with convection and electrochemical boundary conditions are solved for in the **Electroanalysis** interface.



Even if you think a problem will involve the full Nernst–Planck equations, it is best to set the model up in **Secondary Current Distribution** first, in order to identify any other possible complications in the system while using a simpler electrochemical model.



Theory for the Current Distribution Interfaces

Modeling Electrochemical Reactions

Electrochemical reactions are defined by using **Electrode Reaction** or **Porous Electrode Reaction** nodes. An electrode reaction is defined by its thermodynamics, kinetics, and stoichiometry. The latter describes the mass fluxes, sources, and sinks arising due to a certain current density of the reaction.

THERMODYNAMICS OF ELECTROCHEMICAL REACTIONS

An electrolytic reaction involves the exchange of electrons with the electrode. Such a reaction is written as reduction, even if the reaction occurs predominantly in the oxidative direction. For example:

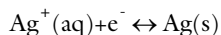

This reaction is called a “half-cell” reaction, since it will occur at a specific electrode-electrolyte interface. It cannot occur in isolation, but only when coupled to another half-cell reaction within a two-electrode electrochemical cell. Each reaction has a characteristic Gibbs energy change that determines whether or not it is thermodynamically favorable. A negative Gibbs energy change means that the reaction proceeds spontaneously — it is thermodynamically “downhill”.

The Gibbs energy change is related to the equilibrium potential difference from the electrode to the electrolyte according to:

$$E_{\text{eq}, m} = -\frac{\Delta G_m}{n_m F}$$

where $E_{\text{eq}, m}$ is the potential difference on some external reference scale for which the reaction is at equilibrium ($\Delta G = 0$). This is called the *equilibrium potential* or *reduction potential* (or in corrosion, *corrosion potential*) of the electrochemical reaction, and its absolute value depends on the choice of reference electrode.



Equilibrium potentials should always be quoted versus a specific reference. If a different reference scale is used in different parts of your model, the thermodynamics of the system may not behave as expected.

From the standard thermodynamic relation

$$\Delta G = -RT \ln K$$

it follows that

$$E - E_{\text{eq}} = \frac{RT}{nF} \ln K$$

This is the Nernst equation which is a universal thermodynamic expression. It is always true of systems at thermodynamic equilibrium; it does not necessarily apply to systems not at equilibrium.

Assuming that the species are ideal and that activity effects can be treated as constant, then for the conversion between unimolecular reduced and oxidized species:

$$[\text{Ox}] = [\text{Red}] \exp\left(\frac{nF}{RT}(\phi_s - \phi_l - E_f)\right)$$

Hence at *equilibrium*, the concentrations of reactants and products at the *electrolyte-electrode surface* are related by an expression which depends on the potential difference between the two phases, and two reaction parameters: n , the number of electrons transferred per molecule reduced; and E_f , the formal reduction potential of the reaction measured on the same potential scale as the electrode-electrolyte potential difference.

The quantity

$$\eta_m = \phi_s - \phi_l - E_{\text{eq},m}$$

is known as the *overpotential* and is particular to a specific reaction occurring at the interface.



η_m depends on both the electric potential in the electrode ϕ_s and the electrolyte potential ϕ_l . Where there is substantial resistance to current flow through a solution, the corresponding potential difference in ϕ_l called *ohmic drop*, alters the position of the electrochemical equilibrium. Additional applied potential in the electrical circuit may then be needed to drive an equivalent overpotential.

KINETICS OF ELECTROCHEMICAL REACTIONS

The Nernst equation tells us the position of equilibrium of a reaction. However, it tells us nothing about how fast the system may get there. If there is a kinetic limitation — that is, if the reaction proceeds slowly — the equilibrium condition may never be observed. As a familiar example, diamond is thermodynamically unstable with respect to reacting to form graphite at room temperature and pressure. However, this reaction is kinetically limited by a vast activation energy for the reorientation of atoms, such that it is never in practice observed, and diamond is technically described as *metastable*.

We encounter the same issue in many electrochemical contexts. Reactions are prevented from proceeding to their equilibrium by kinetic limitations. Indeed, overcoming the natural kinetic sluggishness of the surface reactions of small, nonpolar molecules such as hydrogen and oxygen is key to much fuel cell research.

There are two important expressions describing the current density due to an electrochemical reaction as a function of the overpotential and the concentrations of reactant and product. It should be noted that the validity of these expressions is not general and can never replace experimental kinetic data if such is available.

The first is the *Tafel law* which describes an irreversible anodic or cathodic process:

$$\log\left(\frac{i}{i_0}\right) = A\eta$$

The constant A is the *Tafel slope* and has units $1/V$. It is usually close to a half-integer multiple of F/RT and is less than or equal to nF/RT . Note that a reference *exchange current density* i_0 must be specified for the reaction. This is by definition the current density drawn at zero overpotential.



The Tafel law assumes that a reaction is irreversible. If the reverse reaction might occur in practice, Tafel kinetics will not be correct.

The second expression is the *Butler–Volmer equation*, which describes a reversible process, so that either anodic or cathodic current may flow depending on the sign and magnitude of the overpotential:

$$i = i_0 \left(\exp\left(\frac{\alpha_a F \eta}{RT}\right) - \exp\left(\frac{-\alpha_c F \eta}{RT}\right) \right)$$



The Butler–Volmer equation is the most general description of electrode kinetics. It is highly adaptable because:

- i_0 is an empirical quantity.
- It agrees with the Nernst equation when $i = 0$, so for a very fast reaction ($i_0 \rightarrow \infty$) then the Butler–Volmer equation gives the same potential difference as the Nernst equation. This is equally true under high resistance conditions.
- It agrees with the Tafel equation when either the anodic or cathodic term dominates. For highly irreversible reactions (very low i_0), appreciable current is only drawn for large overpotential, so this is typically the case.

For a discussion on the Butler–Volmer expression and concentration changes of the participating species, see the [Defining Concentration Dependent Butler–Volmer Kinetics](#) section below.

For a reversible reaction at very low overpotential (η of order $RT/F \sim 25$ mV), the exponentials in the Butler–Volmer equation can be linearized:

$$i_{\text{loc}} = i_0 \left(\frac{(\alpha_a + \alpha_c)F}{RT} \right) \eta$$

	Using a linearized Butler–Volmer reaction can be advantageous when investigating convergence issues of a model.
	The linearized Butler–Volmer equation is not correct for applied overpotentials larger than (RT/F) . This is about 25 mV at room temperature. It is not suitable outside this range and therefore its use is confined to electrochemical processes occurring exclusively at low current density, such as electroplating or electrochemical impedance spectroscopy.
	Electrode Kinetics Expressions

FLUXES AND SOURCES/SINKS DUE TO ELECTRODE REACTIONS

Electrode reactions will result in a molecular flux of reacting species to or from the electrode surface. If you are including mass transport in your model it is common to couple the flux of a reacting species on a boundary to the electrode reaction current density (by the Faraday’s law of electrolysis).



The coupling of chemical flux to electric current density is automated in some of the Electrochemistry interfaces by defining the reaction stoichiometry in the **Electrode Reaction** and **Porous Electrode Reaction** nodes. In the Chemical species transport interfaces the coupling however needs to be set up manually by the [Electrode Surface Coupling](#) nodes. When modeling porous electrodes, the corresponding coupling node to create a source/sink in a domain is the [Porous Electrode Coupling](#) node.

The mathematical treatment can be summed up by the expression:

$$N_j = -\frac{\nu_j m i_m}{n_m F}$$

This means that the flux N_j of chemical species j into the surface is proportional to the current density i_m due to reaction m drawn at an electrode-electrolyte interface. The constant of proportionality is the stoichiometric number for the species divided by n_m , the number of electrons transferred in reaction m , in a reductive direction and F the Faraday constant (96,485 C/mol, the absolute charge on a mole of electrons).

As such, knowledge of the stoichiometry of an electrochemical reaction allows the local flux of a chemical species to be coupled to the current density contributed by that reaction. Note that multiple reactions may take place simultaneously at an electrode, and their contributions to the current density are simply summed.

	The stoichiometric coefficients of the chemical species in an electrochemical reaction are conventionally written with the forward reaction in the direction of reduction, even if in practice within the system the reaction predominantly proceeds in the other direction.
	COMSOL Multiphysics uses the standard convention that anodic (oxidative) current is positive. Cathodic (reductive) current is negative.

DEFINING CONCENTRATION DEPENDENT BUTLER-VOLMER KINETICS

If the concentrations at an electrode surface change, this will have an impact on the local kinetics. The Butler-Volmer kinetics expression is derived by considering the rate of a redox reaction

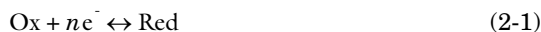

as the sum of the forward and backward rates according to:

$$r = \frac{i_{\text{loc}}}{nF} = k_{\text{fwd}} c_R \exp\left(\frac{\alpha_a F E}{RT}\right) - k_{\text{rwd}} c_O \exp\left(-\frac{\alpha_c F E}{RT}\right) \quad (2-2)$$

where k_{fwd} and k_{rwd} are reaction rate constants and c_O and c_R are the activities of the oxidized and reduced species of the redox couple, respectively. The potential E is here defined as

$$E = \phi_s - \phi_l \quad (2-3)$$

and the transfer coefficients are equal the sum of electrons in the charge transfer reaction according to

$$\alpha_a + \alpha_c = n \quad (2-4)$$

By defining an equilibrium potential at which the forward reaction and backward reaction rates are equal, Equation 2-1 can be shown to be equivalent to the commonly used Butler–Volmer equation:

$$i_{\text{loc}} = i_0 \left(\exp\left(\frac{\alpha_a F \eta}{RT}\right) - \exp\left(-\frac{\alpha_c F \eta}{RT}\right) \right) \quad (2-5)$$

In this formulation, assuming the stoichiometric coefficients of the oxidized and reduced species to be -1 and 1 , respectively, the exchange current density, i_0 , is defined as:

$$i_0 = i_{0, \text{ref}} \frac{c_R}{c_{R, \text{ref}}}^{\alpha_c/n} \frac{c_O}{c_{O, \text{ref}}}^{\alpha_a/n} \quad (2-6)$$

where $i_{0, \text{ref}}$ is the exchange current density at some chosen reference conditions, and the overpotential is defined as

$$\eta = E - E_{\text{eq}} \quad (2-7)$$

where E_{eq} is the equilibrium potential is defined by the Nernst equation as

$$E_{\text{eq}} = E_{\text{eq, ref}} - \frac{RT}{nF} \ln \frac{c_R/c_{R, \text{ref}}}{c_O/c_{O, \text{ref}}} \quad (2-8)$$

and $E_{\text{eq, ref}}$ is the equilibrium potential at the same reference conditions.

Typically standard conditions are used as reference concentrations, for instance concentrations of 1 M for ions in aqueous solutions.

Note that in Equation 2-5 both i_0 and E_{eq} are concentration dependent. This has some numerical drawbacks when modeling electrochemical cells including mass transport, since for low concentrations of the participating species (that is, when $c_O \rightarrow 0$ or $c_R \rightarrow 0$), the factor $\ln(c_R/c_O)$ may become undefined during the solution process. An expression of the form of Equation 2-2 is more desirable since this expressions contains a simple linear dependence on the species activities.

A common solution to this issue is to rewrite the Butler–Volmer expression by defining the overpotential with respect to a fixed reference state for the activities $c_{R, \text{ref}}$ and $c_{O, \text{ref}}$ (typically corresponding to the inlet or initial concentrations), resulting in

$$i_{\text{loc}} = i_{0, \text{ref}} \left(\frac{c_R}{c_{R, \text{ref}}} \exp\left(\frac{\alpha_a F \eta_{\text{ref}}}{RT}\right) - \frac{c_O}{c_{O, \text{ref}}} \exp\left(-\frac{\alpha_c F \eta_{\text{ref}}}{RT}\right) \right) \quad (2-9)$$

where

$$\eta_{\text{ref}} = E - E_{\text{eq,ref}} \quad (2-10)$$

Note that [Equation 2-9](#) now contains a linear dependence on the activities c_O and c_R .

Double Layer Capacitance

The Tafel and Butler–Volmer expressions can be used to calculate the magnitude of the current due to electrolysis: this is called *faradaic current*. However, the electrode-electrolyte interface may also draw capacitive current due to the attraction or repulsion of ions creating an oppositely charged layer of ions to form in solution close to the electrode.

The layer of charge on the electrode and layer of opposite charge in the adjacent electrolyte is called the *double layer* and can be thought of as behaving like a parallel plate capacitor, since the absolute amount of charge it separates varies with the charge density on the electrode, and hence with its voltage. The physics of double layer structure and formation are highly complex and are not yet well understood. One of the simplest empirical methods to account for the observed influence of capacitance on polarization curves is to introduce a constant ideal capacitance across the electrode-electrolyte interface.

This effect can be added to via the **Double Layer Capacitance** condition. The capacitor stores a surface charge density $Q = C_d(\phi_s - \phi_l)$, and contributes a dynamic charging current density (*nonfaradaic current*) equal to $i_{\text{NF}} = dQ/dt$. The total current recorded in a real experiment equals:

$$i_{\text{tot}} = i_{\text{Far}} + i_{\text{NF}}$$

Sometimes in electroanalysis a blank scan with no electrolysis is run to subtract nonfaradaic current. If double layer capacitance is ignored in your model, you should

make sure that you are comparing it to experimental data recorded under the same conditions.



The ability of COMSOL Multiphysics to model electrostatics and transport of charged species make it tempting to incorporate the double layer explicitly to add more detail to a model. These coupled equations are always extremely nonlinear and convergence is not trivial except in the simplest cases. Although the diffuse double layer can be modeled in isolation (see example), this is not recommended in conjunction with a fuller electrochemical model.



Double-Layer Capacitance



Porous Electrodes

A porous electrode is one in which the three-dimensional structure of the electrode is permeable to electrolyte. The electrode-electrolyte interface then extends over a much larger surface area. This specific surface area (“SSA”, area per unit volume, units $1/m$) is a key property of a porous electrode. Additionally, such an electrode can conduct electrical current independently through its electrode and electrolyte domains.

Most electrochemical interfaces in COMSOL Multiphysics include **Porous Electrode** domain nodes that can be used to model the above situation. In a **Porous Electrode**, current density is carried in both the electrode and in the pores which are assumed to contain electrolyte. For gas diffusion electrodes where the solid is conducting but the pore phase is not, the **Electrode** condition should be used.

It is common to combine an electrochemical interface with other physics, in order to model the mass transport, heat transfer and flow properties of a porous medium. For

instance, **Secondary Current Distribution** might be coupled to **Transport of Diluted Species in Porous Media**, **Heat Transfer in Porous Media**, and **Darcy's Law**.

	Homogenized transport parameters such as diffusion coefficients are commonly obtained for a bulk solution of the material. In porous media these must be corrected for tortuosity and porosity. Carefully consider such effects when defining your material properties.
	Porous Electrode Theory

Boundary Conditions for Running and Controlling Electrochemical Cells

An electrochemical cell is typically operated by controlling either the cell voltage (potentiostatic control) or the cell current (galvanostatic control). In a lab experiment this is accomplished by using a potentiostat.

In a model, potentiostatic control is defined by using fixed potential boundary conditions. This can be done by setting the **Electric Potential** with respect to ground to control the cell potential, or the **Electrode Potential** with respect to a reference potential somewhere in the system. Galvanostatic control can be accomplished using **Total Current** or **Average Current Density** boundary conditions. For both cases, one electrode in the cell needs to be grounded.

Mathematically, a **Total Current** or **Average Current Density** condition implies setting the potential of a boundary to be equal to an additional extra global potential degree of freedom (floating potential) to comply with the specified current condition. For this reason, solving for galvanic control is numerically slightly more complex.

Note that explicitly prescribing the current density distribution on an electrode boundary is hard to accomplish in a real world experiment. In higher dimensions than 1D, **Electrode Current Density** and **Electrolyte Current Density** boundary conditions should be used with care.

SHORT-CIRCUITING A CELL AND GALVANIC CORROSION

The simplest way to model a short-circuited cell is to set both electrodes to the same (electronic) potential, using a fixed potential boundary condition. The charge balance

equation of the electrolyte will make sure the total current over all electrode surfaces sums up to zero.

Note that many galvanic corrosion situations are practically equivalent to a short circuit of two electrodes consisting of different metals. In such models, the two metals are set to the same potential. Usually this potential is chosen to be zero (ground).



- [Electrode Potential](#)
 - [Reference Electrode](#)
-

Battery Modeling

Batteries are electrochemical energy extraction/storage devices that work by using a conducting domain to separate two regions, where the two halves of an overall favorable chemical reaction proceed. By preventing the mixing of reactants and instead forcing the reaction to proceed by mediation of electrical current between the separated reactants, energy can be extracted as a voltage.

In a battery, there is a finite supply of reactant and the system is closed. A battery does not have a steady state condition since its feedstock of reactants progressively depletes until it is consumed. Once consumed, the battery is *discharged* and it will no longer provide a voltage as its source of electrochemical energy has run out. In a rechargeable battery, the process is reversible and the application of a voltage can return the battery to saturation with feedstock under charging.



The electrochemistry in a battery model usually does not have a steady state, and so it is not appropriate to use a Stationary study with a battery interface.

The maximum achievable voltage in a battery or fuel cell is the difference between the half-cell potentials. The discharge mode is the direction in which the overall reaction is thermodynamically downhill (negative ΔG).



There can be variation in the literature between whether the charge or discharge mode is assumed when an electrode in a battery is referred to as the “anode” or “cathode”. Each electrode can operate in both roles, depending on whether the battery is charging or discharging.

Generic battery models can be set up using the **Tertiary Current Distribution** interface to describe charge transport coupled to species transport is required.

The **Lumped Battery** interface and **Battery Equivalent Circuit** interfaces are general “black box”-approach interfaces, which make use of global equations and parameters, typically fitted to experimental data, for capturing the battery cell dynamic charge-discharge behavior.

The **Single Particle Battery** interface is a generic interface for modeling intercalation electrode-based batteries. It may be viewed as a semi-lumped version of the Lithium-ion and Battery with Binary Electrolyte interfaces described below.

TAILOR MADE BATTERY INTERFACES

Certain common battery types have predefined physics interfaces. Common for all these interfaces is that by the use of concentrated electrolyte theory for the charge and mass transport in the electrolyte, a more accurate electrolyte transport model is achieved, compared to the Nernst–Planck equations described earlier in this chapter.

Lithium-ion Battery is used for solving problems in batteries where the anode (in discharge mode) is lithium metal intercalated into a material such as graphite, and the cathode (in discharge mode) is lithium ions intercalated into a transition metal oxide. The electrical current through the electrolyte is carried by lithium ions, typically in an organic solution. Because both the anode and cathode materials are typically porous to maximize the active surface area, the **Porous Electrode** domain node is standard to define each electrode.

The **Battery with Binary Electrolyte** interface can be used for a range of general battery types involving porous electrodes and current transfer through an ionic conductor. An example is the nickel–metal hydride battery — an early type of rechargeable battery in which the discharge anode is a metal hydride, the discharge cathode is a hydrated nickel oxide, and the current is transferred by high concentration potassium hydroxide in aqueous solution.

The **Lead–Acid Battery** interface is designed for batteries in which the discharge process is the comproportionation of Pb(0) and Pb(IV) through a sulfuric acid medium.

Modeling Cyclic Voltammetry

In a cyclic voltammetry experiment, a potentiostat is used to sweep the voltage at the working electrode linearly from a start potential to a vertex potential, and back again. Typically, the potential window is chosen to span the formal potential of a redox couple

of interest, allowing both the kinetics and transport properties of the chemical species to be investigated. The target species reacts under kinetic control to the point of depletion where the current becomes transport-controlled.

The built-in **Cyclic Voltammetry** study step in the **Electroanalysis** interface can be used to automatically set up the voltage sweep in a time-dependent study.

Common Simplifications When Modeling Electrochemical Cells

SHOULD I MODEL IN 3D OR CAN I MODEL IN 1D?

Many electrochemical systems use repetitive unit cells of high aspect ratio. In these cases, the lumped effect of edge phenomena in the system will be small. For example, in fuel cells or batteries it is often possible to use one-dimensional geometries with little loss of detail. Consider also any mirror or rotational symmetries. Reducing the geometry dimension where possible, either exactly or approximately, will reduce the meshing and solving time significantly.



Starting with a 1D model helps to understand the influence of different reactions and phenomena in an electrochemical system, and gives a good first estimate of current-voltage behavior.

NEGLECTING THE CHARGE TRANSFER AND POTENTIAL GRADIENTS IN ELECTRODES

The voltage over the surface of an electrode is typically constant — or very nearly constant — since it is a good conductor. This implies that it is either the intrinsic resistance of the electrolyte or the rate of the electrochemical reaction at the electrode-electrolyte interface that controls the amount of current drawn in an electrochemical cell. On the assumption of a constant surface voltage, the electrode domain itself need not be modeled, and the coupling of charge and mass transport at its surface treated by an **Electrode Surface** node.



[Electrode Surface](#)

However, when modeling porous and gas diffusion electrodes the metal phase potential is need typically to be included since the conductivity of the metal phase

potential can be much lower in this type of electrodes. This is done in the **Porous Electrode** nodes.

HALF-CELL MODELS

Often, an investigator is only interested in the chemistry taking place at one electrode in a cell. A model of one electrode is called a “half-cell model”.

This would correspond to an experimental situation where the electrode of interest — be it anode or cathode — is classified as the *working electrode*, and the other electrode is called the *counter electrode*.

One usually ignores the kinetics of the counter electrode in a model; commonly it is represented by a constant potential boundary condition. Such a model is only valid if the counter electrode can draw arbitrarily large amounts of current compared to the working electrode, so that it never limits the current flow in the electrochemical cell.

REPLACING THIN LAYERS WITH BOUNDARY CONDITIONS

When considering a layer that is very thin compared to other dimensions in the geometry, it is usually correct to treat that layer using a physical condition, rather than meshing it.

One important example is the catalyst layer in a fuel cell. Since this layer is only nanometers in size, transport across it is very fast compared to other parts of the system. Hence, it is not necessary to resolve a distribution of concentrations or potentials through the layer.

Another example is the passivation layer on an oxidized electrode surface, for which the “Thin Film Resistance” setting can be used. Because the layer is much thinner than its surroundings, the electric field through it is almost constant. Therefore, an ohmic expression can be substituted to create a boundary condition with a potential drop. This is much more efficient than meshing a geometrically narrow layer.



Film Resistance

INFINITE ELEMENTS FOR STEADY-STATE ELECTROANALYSIS

For microelectrodes, the diffusion profile may approach a steady state whose size is much larger than that of the working electrode of interest. In such an example, it is preferable to circumscribe the simulation space to a region not more than about

twenty-five times the electrode size - assuming that the surrounding electrolyte is uniform. Applying a bulk boundary condition such as a fixed concentration at this finite distance causes inaccuracy in the solution, however.

It is better to use a layer of **Infinite Elements** around the finite simulation space to project the simulation space to infinity, eliminating any error from artificially limiting the simulation space. This is a typical approximation when the electrolyte domain is a few orders of magnitude larger than the electrode: for example, a microelectrode in a cm-scale reaction vessel.



Infinite Elements, Perfectly Matched Layers, and Absorbing Layers in the
COMSOL Multiphysics Reference Manual

Before You Start Building Your Model

INTRODUCING COMPLEXITY ONE STEP AT A TIME

The true art of modeling is knowing what phenomena to include and what phenomena to neglect. Building complexity in a model by adding one additional piece of physics or geometric feature at a time is usually the fastest way to reach the modeling goal.

Here are some general tips:

- Start thinking about your cell in the lowest possible dimension. Starting with a 1D model helps to understand the influence of different reactions in an electrochemical system, and gives a good first estimate of current-voltage behavior. Go from 1D to 2D, then from 2D to 3D.
- Every electrode reaction adds numerical nonlinearities to your model. If you have multiple electrode reactions, add them one at a time.
- Start with a simple description of the electrolyte current, such as **Secondary Current Distribution**. Analyze the results to ensure that the electrochemical model is consistent. Switch only to more complex electrolyte models, or add extra physics such as mass transfer, heat transfer or flow, only if deemed necessary and when satisfied with the results from a simpler case.
- If you are including flow in your model, solve for the flow field first before coupling flow and electrochemistry together.

MODELING CHECKLIST

- Identify which domains are electrode and electrolyte. How will their conductivity be assessed?
- What is happening on the electrode-electrolyte interfaces? Do both the anode and the cathode need to be modeled? Do either need to be modeled as domains, or can they be treated as boundaries?
- What electrochemical reactions take place at the electrode surfaces to cause charge transfer? Can you parameterize their thermodynamics? Do you know the equilibrium potentials? Can you parameterize their kinetics — and are the kinetics ever going to be important? If not, ignore them.
- What is the system reference potential used to quote equilibrium potentials? Where is the system ground?
- Are charge carriers in the electrolyte plentiful with respect to the drawn current density, or is charge depletion important? Be aware of nonlinear effects that may make convergence more difficult.
- If you are performing a time-dependent study, do your initial conditions have a consistent current-voltage relationship?
- What other physics interfaces need to be coupled? How does charge transfer influence these physics interfaces?

Meshing Advice

The default triangular (2D) or tetrahedral (3D) mesh is normally suitable for solving the equations describing conservation of charge and mass for a general electrochemical problem.

Electrochemical models involving mass transport generally benefit from a finer mesh at the electrode surfaces, and at singularities such as the boundary between an electrode surface and an insulating surface. This may be accomplished by adding additional **Size** mesh nodes for these boundaries only. Also, consider refining the “element growth rate”, and/or using boundary layer meshing in 3D.

Sometimes, a regular **Mapped** mesh can be more appropriate in a rectangular (2D) domain; such domains are common in cutaway schematic studies of batteries and fuel cells. Similarly the **Swept** mesh is often appropriate for very thin layers in a 3D model.

For fluid domains, the default physics-controlled mesh should be used, with boundary layers as required.

For some problems with a stationary flow velocity field and time-dependent convection of electrochemically reacting species, it may improve convergence to set up a refined mesh without boundary layers for the species transport study step.



Solving Electrochemical Models

Due to the highly nonlinear nature of electrode kinetics, some electrochemical models can be difficult to solve. This section includes some general tips and tricks to facilitate model solving, trouble shooting, and to improve solution accuracy.

GENERAL CURRENT DISTRIBUTION PROBLEMS

Start with the following suggestions if you encounter difficulty solving a problem.

- Make sure that the potential levels are “boot-strapped” somewhere in the model, preferably by grounding one electrode. If there is no potential level defined anywhere in the model, your model may have infinitely many solutions, and the model will not converge.
- Consider using a **Stationary with Initialization** or a **Time Dependent with Initialization** study. Both these studies will use a **Current Distribution Initialization** study step as a first step to solve for the potentials only. If you run into problems solving for the second step in this study you may have to change the “Current distribution type” setting to **Secondary** on the **Current Distribution Initialization** study step node, and also review the **Initial Values** as described in the next bullet.
- Review the **Initial Values**, especially the potentials. Suitable initial potential values can usually be derived making a “potential walk” through the geometry, starting at the grounded boundary. Compute electric and electrolyte potentials in other domains by assuming equilibrium potential differences between electrode and electrolyte for the main electrode reactions.
- Switch to **Linearized Butler-Volmer** kinetics (or a **Primary** current distribution) while troubleshooting. This can be useful to help achieve a solution for a model that does

not solve with nonlinear kinetics, thereby indicating suitable initial values for the nonlinear problem.

- If your model contains porous electrodes, try refining the mesh resolution in these domains, especially toward the electrolyte boundaries.



- [Electrochemistry Interfaces](#)
 - [Specifying Initial Values](#) and [Inspecting and Troubleshooting Meshes](#) in the *COMSOL Multiphysics Reference Manual*
-

ELECTROCHEMISTRY COUPLED TO MASS TRANSPORT

If the model involves electrochemistry coupled to mass transport, here are a few things to try to help improve model convergence.

- Review the **Initial Values** for the concentration values. Zero initial concentration values can be unsuitable for tertiary current distribution problems and battery simulations, since they could imply that no charge carriers or no reacting material is present.
- If steep concentration gradients are expected close to electrode surfaces, use boundary layer meshing or finer mesh **Size** settings at these boundaries.
- When setting up user-defined kinetics expressions, avoid evaluating negative concentrations by using expressions such as $\max(c, \text{eps}^2)$, where eps is the machine epsilon (a very small but finite number).
- Try to solve for low currents and low overpotentials first, then increase the cell load (for stationary problems this can be done using an auxiliary sweep with continuation).
- If a problem involving mass transport is hard to solve for high currents, but solves for low currents, it might be due to mass transport limitations. In this case, review the transport parameter values and check that the current magnitudes are reasonable. If the current densities are unreasonably high, review the electrode reaction settings.
- For time-dependent problems that run into convergence problems after a certain time, review the solution at the last time-step. If the solution of a reactant reaches zero or a maximum value (for insertion electrodes in batteries) when the

convergence issues occur, the current load of the model is too high in relation to your initial concentrations or mass transport properties.



- [Electrochemistry Interfaces](#)

In the *COMSOL Multiphysics Reference Manual*:

- [2D and 3D Boundary Layer Meshes](#)
- [Stationary and Parametric Sweep](#)

SETTING UP A STUDY SEQUENCE FOR MULTIPHYSICS PROBLEMS

For multiphysics problems, try to adjust the study sequence.

- Solve certain physics interfaces in a sequence. This can in many cases reduce computational time and improve convergence. Analyzing the results when solving a physics interface separately can also help when troubleshooting a nonconverging model.
- A good strategy is often to solve for the potentials only (that is, disable mass transport and flow interfaces), using a stationary study step, before solving the full model in the study sequence. In this way the stationary solution is used as initial values for the following steps. This can be manually by modifying the settings of the study node, or in an automated way by using the **Stationary with Initialization** or **Time Dependent with Initialization** study sequences, as described above.
- In many models the flow profile is only slightly (or not at all) affected by changes in current density. Therefore it can be a good strategy to solve separately for the flow early in the study sequence, and then solve for the other physics interfaces in the subsequent steps. (If the flow is not affected at all by the current distribution, solving for the flow can be disabled entirely in consecutive steps.)



- [Electrochemistry Interfaces](#)

In the *COMSOL Multiphysics Reference Manual*:

- [Studies and Solvers](#)
- [Analyzing Model Convergence and Accuracy](#)
- [Achieving Convergence When Solving Nonlinear Equations](#)

TIME-DEPENDENT PROBLEMS WITH LOAD STEPS

For time-dependent problems, try the following to address accuracy and convergence issues with regards to sudden current or potential load steps.

- Use smoothed current or potential load functions in order to avoid instantaneous or discrete load steps.
- Add a double layer capacitance to the model, which can improve the numerical stability.
- Reduce the **Maximum step** taken by the solver if you want to prevent the solver from “missing” short square load steps, or change the **Steps taken by solver** setting from **Free** to **Strict**, or **Intermediate**, to control the time steps using the **Times** text field. Using the Events interface can also be an option in certain cases if the load cycle itself varies dynamically.



- [Double-Layer Capacitance](#)

In the *COMSOL Multiphysics Reference Manual*:

- [Step and Time Dependent](#)
 - [Building a COMSOL Multiphysics Model](#) and [The Events Interface](#)
-

SOLVER SETTINGS





Try adjusting the solver settings.

- In rare cases, try to increase the **Maximum number of iterations**.
- If you know the order of magnitude of the dependent variables beforehand, setting the scaling method to **Manual** for these can improve convergence and the accuracy of the results. This may be of special importance when solving for concentrations that are initially very small but where the final order of magnitude is known *a priori*. This could be the case for the active species in a battery model, for example.



In the *COMSOL Multiphysics Reference Manual*:

- [Studies and Solvers](#)
 - [Analyzing Model Convergence and Accuracy](#)
 - [Achieving Convergence When Solving Nonlinear Equations](#)
-

	Electrochemistry Studies and Study Steps and Cyclic Voltammetry in the <i>COMSOL Multiphysics Reference Manual</i>
	In multicomponent systems it is rarely straightforward to predict the rest potential and direction of current flow. The Current Initialization step in COMSOL Multiphysics does this for you but is only correct if concentrations and formal potentials for all electrode reactions are specified precisely and with respect to a common reference scale.
	Electrochemistry Studies and Study Steps in the <i>COMSOL Multiphysics Reference Manual</i>
	Studies and Solvers and Building a COMSOL Multiphysics Model in the <i>COMSOL Multiphysics Reference Manual</i>

Postprocessing Your Solution

POTENTIAL VARIABLES

Several different potential variables are available for postprocessing and during computation. The most common ones are described in [Table 2-1](#).

TABLE 2-1: COMMON POTENTIAL VARIABLES.

VARIABLE	DESCRIPTION	DEFINED AT
phil	Electrolyte phase potential	Electrolyte and Porous Electrode domains
phis	Electrode phase potential	Electrode and Porous Electrode domains
xxx.phisext	Electrode phase potential	Electrode Reaction boundaries to Electrolyte domains

TABLE 2-1: COMMON POTENTIAL VARIABLES.

VARIABLE	DESCRIPTION	DEFINED AT
xxx.Eq_yy	Equilibrium potential	Electrode Reaction boundaries and Porous Electrode Reaction domains
xxx.eta_yy	Overpotential	Electrode Reaction boundaries

The unit is V for all the above variables.

xxx denotes the tag of the physics interface. For instance, cd for the Secondary Current Distribution interface.

yy denotes the tag of the (Porous) Electrode Reaction node, for instance, er1 for an Electrode Reaction node.

CURRENT VARIABLES AND CALCULATING THE TOTAL CELL CURRENT

The current density may vary between locations on an electrode surface. This effect is very important to understand through modeling because it cannot be directly measured. Experimental measurement can only return the total current drawn at an electrode, although the variation in current density can be inferred by other means.

To calculate the total current in COMSOL Multiphysics, it is necessary to integrate the total drawn current density along the boundary or over the domain of the electrode. Some common current density variables are shown in [Table 2-2](#).

TABLE 2-2: COMMON CURRENT DENSITY VARIABLES.



VARIABLE	UNIT	DESCRIPTION	DEFINED AT
xxx.nll	A/m ²	Electrolyte current density in normal direction	Boundaries to Electrolyte and Porous Electrode domains
xxx.nls	A/m ²	Electrode current density in normal direction	Boundaries to Electrolyte and Porous Electrode domains
xxx.iloc_yy	A/m ²	Local current density of electrode reaction	Electrode Reaction boundaries
xxx.itot	A/m ²	Total interface current density (local sum of all xxx.iloc_yy)	Electrode Reaction boundaries
xxx.iv_yy	A/m ³	Volumetric current density of a Porous Electrode Reaction	Porous Electrode domains
xxx.ivtot	A/m ³	Total volumetric current densities (local sum of all xxx.iv_yy)	Porous Electrode domains
xxx.lIMag	A/m ²	Electrolyte current density magnitude (L ² norm)	Electrolyte domains
xxx.lSMag	A/m ²	Electrode current density magnitude (L ² norm)	Electrode domains

xxx denotes the tag of the physics interface. For instance **cd** for the Secondary Current Distribution interface.

yy denotes the tag of the (Porous) Electrode Reaction node, For instance **erl** for an Electrode Reaction node.

In 1D or 1D axisymmetric, the electrode is implicitly uniform so you can just multiply by the area of the electrode. In 2D or 2D axisymmetric, compute the appropriate line integral. In 3D, compute the surface integral.

You can also define your own total current variable by using an **Integration** nonlocal coupling across the electroactive boundaries. This variable can also be used during the computation. In 1D axisymmetric and 2D axisymmetric components, make sure to select the **Compute integral in revolved geometry** check box.

	In the <i>COMSOL Multiphysics Reference Manual</i> : <ul style="list-style-type: none">• Nonlocal Couplings and Coupling Operators and Integration
	Avoid evaluating the xxx.lIMag/xxx.lSMag variables on boundaries. These are generally less accurate than the xxx.nll/xxx.nls variables.

Connecting to Electrical Circuits

In this section:

- [About Connecting Electrical Circuits to Physics Interfaces](#)
- [Connecting Electrical Circuits Using Predefined Couplings](#)
- [Connecting Electrical Circuits by User-Defined Couplings](#)
- [Solving](#)
- [Postprocessing](#)

About Connecting Electrical Circuits to Physics Interfaces

This section describes the various ways electrical circuits can be connected to other physics interfaces in COMSOL Multiphysics. If you are not familiar with circuit modeling, it is recommended that you review the [Theory for the Electrical Circuit Interface](#).

In general electrical circuits connect to other physics interfaces via one or more of three special circuit features:

- [External I vs. U](#)
- [External U vs. I](#)
- [External I-Terminal](#)

These features either accept a voltage measurement from the connecting noncircuit physics interface and return a current from a Battery or Current Distribution Interface (or an Electrical Circuit interface), or the other way around.



The “External” features are considered “ideal” current or voltage sources by the Electrical Circuit interface. Hence, you cannot connect them directly in parallel (voltage sources) or in series (current sources) with other ideal sources. This results in the error message *The DAE is structurally inconsistent*. A workaround is to provide a suitable parallel or series resistor, which can be tuned to minimize its influence on the results.

Connecting Electrical Circuits Using Predefined Couplings

In addition to these circuit features, interfaces in the AC/DC Module, RF Module, MEMS Module, Plasma Module, and Semiconductor Module (the modules that include the Electrical Circuit interface) also contain features that provide couplings to the Electrical Circuit interface by accepting a voltage or a current from one of the specific circuit features ([External I vs. U](#), [External U vs. I](#), and [External I-Terminal](#)).

This coupling is typically activated when:

- A choice is made in the **Settings** window for the noncircuit physics interface feature, which then announces (that is, includes) the coupling to the Battery or Current Distribution (or Electrical Circuit) interface. Its voltage is then included to make it visible to the connecting circuit feature.
- A voltage that has been announced (that is, included) is selected in a feature node's **Settings** window.

These circuit connections are supported in Circuit Terminals.

Connecting Electrical Circuits by User-Defined Couplings

A more general way to connect a physics interface to the Electrical Circuit interface is to:

- Apply the voltage or current from the connecting “External” circuit feature as an excitation in the noncircuit physics interface.
- Define your own voltage or current measurement in the noncircuit physics interface using variables, coupling operators and so forth.
- In the **Settings** window for the Electrical Circuit interface feature, selecting the User-defined option and entering the name of the variable or expression using coupling operators defined in the previous step.

DETERMINING A CURRENT OR VOLTAGE VARIABLE NAME

To determine a current or voltage variable name, look at the **Dependent Variables** node under the **Study** node. To do this:

- 1 In the **Model Builder**, right-click the **Study** node and select **Show Default Solver**.

- Expand the **Solver>Dependent Variables** node and click the state node, in this example, **Current through device R1 (comp1.currents)**. The variable name is shown in the **Settings** window for **State**.

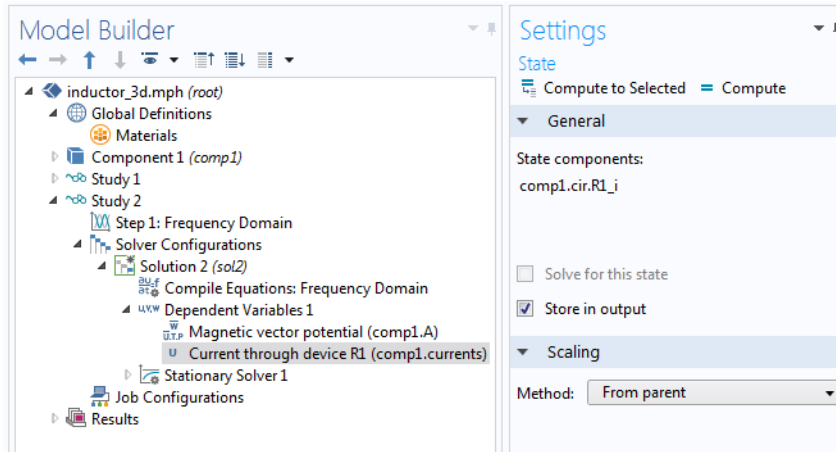

Typically, voltage variables are named `cir.Xn_v` and current variables `cir.Xn_i`, where n is the “External” device number — 1, 2, and so on.

Solving



Some modeling errors lead to the error message *The DAE is structurally inconsistent* being displayed when solving. This error typically occurs from having an open current loop, from connecting voltage sources in parallel, or connecting current sources in series.

In this respect, the predefined coupling features are also treated as (ideal) voltage or current sources. The remedy is to close current loops and to connect resistors in series with voltage sources or in parallel with current sources.

Postprocessing

The Electrical Circuits interface, unlike most of the other physics interfaces, solves for a relatively large number of global dependent variables (such as voltages and currents), instead of solving for a few space-varying fields (such as temperature or displacement). For this reason, the Electrical Circuit interface does not provide default plots when computing a study.

The physics interface defines a number of variables that can be used in postprocessing. All variables defined by the Electrical Circuit interface are of a global scope, and can be evaluated in a **Global Evaluation** node (under **Derived Values**). In addition, the time evolution or dependency on a parameter can be plotted in a **Global** plot (under a **ID Plot Group** node).

The physics interface defines a Node voltage variable for each electrical node in the circuit, with name `cir.v_name`, where `cir` is the physics interface Label and `<name>` is the node Name. For each two-pin component, the physics interface also defines variables containing the voltage across it and the current flowing through it. For resistors it adds a heat source variable as well.

In the *COMSOL Multiphysics Reference Manual*:



- [Derived Values, Evaluation Groups, and Tables and Global Evaluation](#)
 - [Plot Groups and Plots and Global](#)
-

References

1. V. Kaajakari, *Practical MEMS*, Small Gear Publishing, Las Vegas, 2009.
2. S.D. Senturia, *Microsystem Design*, Springer Science and Business Media, New York, 2001.
3. A.F. Bower, *Applied Mechanics of Solids*, CRC Press, Boca Raton, FL, 2010 (<http://www.solidmechanics.org>).

SPICE Import and Export

The following text is a generic description of the SPICE Import and Export functionality available with various add-on products from COMSOL.

SPICE Import

The circuit definition in COMSOL Multiphysics adheres to the SPICE format developed at the University of California, Berkeley ([Ref. 1](#)). SPICE netlists can be imported and the corresponding circuit nodes are generated in the COMSOL Multiphysics model. Most circuit simulators can export to this format or some version of it.

The Electrical Circuit interface supports the following device models:

TABLE 2-3: SUPPORTED SPICE DEVICE MODELS.

STATEMENT	DEVICE MODEL
R	Resistor
C	Capacitor
L	Inductor
V	Voltage Source
I	Current Source
E	Voltage-Controlled Voltage Source
F	Current-Controlled Voltage Source
G	Voltage-Controlled Current Source
H	Current-Controlled Voltage Source
D	Diode
Q	NPN BJT and PNP BJT
M	n-Channel MOSFET and p-Channel MOSFET
X	Subcircuit Instance

Statements corresponding to multiple devices are resolved by parsing the associated `.model` statement. The physics interface also supports the `.subckt` statement, which is represented in COMSOL by a [Subcircuit Definition](#) node, and the `.include` statement. SPICE commands are interpreted case-insensitively. The statement defining each device is also interpreted as the **Device name**.

According to SPICE specification, the first line in the netlist file is assumed to be the title of the netlist and it is ignored by the parser.

SPICE Export

The **SPICE Export** functionality creates a SPICE netlist file containing a description of the circuit represented by the physics interface. This functionality can be accessed from the physics interface context menu (right-click the physics interface node and select **Export SPICE Netlist**). After specifying a filename, the circuit is exported and messages from the export process display in the **Messages** window. During the export process, a series of operations are performed:

- In order to avoid conflicts, each component must be identified by a unique **Device name**. If one or more components have the same device name, the export operation fails and an error message is displayed. All characters in a **Device name** that are not letters, digits, or underscores are replaced by underscores.
- According to the SPICE specification, each circuit must have a node with name 0, which is assumed to be the only ground node. When exporting a circuit, any node with name 0 that is not connected to a **Ground** component is exported with a different node name. All nodes that are connected to a Ground components are exported as a merged node with name 0. The Messages window shows a log message if these operations are performed, showing the name of the renamed or merged nodes.
- All characters in node names that are not letters, digits, or underscores are replaced by underscores.
- Some components (most notably, the **External** components used to couple to other physics interfaces) cannot be exported to a SPICE netlist. These components are ignored during the export process, and a message is shown in the Messages window. Note that this can change the exported circuit, since some components are then missing.
- Subcircuit definitions are added as `.subckt` statements in the netlist. Semiconductor devices (such as MOSFETs, BJTs, and diodes) are exported as a SPICE device with a corresponding `.model` statement.

The title of the exported netlist file is the model's filename, and the time, date, and version of COMSOL Multiphysics is added as a comment in the netlist file.

Reference

1. <http://bwrce.eecs.berkeley.edu/Classes/IcBook/SPICE/>

Battery Interfaces



This chapter describes the physics interfaces found under the **Electrochemistry>Battery Interfaces** branch ().

In this chapter:

- [The Lithium-Ion Battery Interface](#)
- [Lithium-Ion Battery, Deformed Geometry Model Wizard Entry](#)
- [The Battery with Binary Electrolyte Interface](#)
- [The Lead–Acid Battery Interface](#)
- [The Single Particle Battery Interface](#)
- [The Lumped Battery Interface](#)
- [The Battery Equivalent Circuit Model Wizard Entry](#)
- [The Battery Pack Interface](#)
- [Shared Nodes for Battery Interfaces](#)
- [Theory for the Lithium-Ion Battery Interface](#)
- [Theory for the Battery with Binary Electrolyte Interface](#)
- [Theory for the Lead–Acid Battery Interface](#)
- [Theory for the Single Particle Battery Interface](#)

- Theory for the Lumped Battery Interface
- Theory for the Battery Pack Interface

The Lithium-Ion Battery Interface

The **Lithium-Ion Battery (liion)** interface (), found under the **Electrochemistry>Battery Interfaces** branch () when adding a physics interface, is used to compute the potential and current distributions in a lithium-ion battery. Multiple intercalating electrode materials can be used, and voltage losses due to solid-electrolyte-interface (SEI) layers are also included.

The physics interface is based on the works of Newman and others. Ohm's law is used to describe the charge transport in the electrodes. For the electrolyte, concentrated electrolyte theory for a quiescent aprotic (1:1) electrolyte is used to describe charge and mass transport in the electrolyte phase.

Alternatively, a single-ion conductor charge balance, used by default by the **Lithium-Ion Battery, Single-Ion Conductor (liion)** () entry in the model wizard, may be used for the electrolyte. This option is typically applicable to solid electrolytes.

An extra dimension is included in the porous electrode domains to describe the transport of solid lithium in the solid electrode phase using Fick's law.

Dependent Variables and Extra Dimensions

Different combinations of four dependent variables are valid and solved in different domains. The four dependent variables are:

- ϕ_l , electrolyte potential,
- ϕ_s , electric potential in the electrodes,
- c_l , salt concentration in the electrolyte, and
- c_s , solid lithium concentration in the electrode particles in the [Porous Electrode](#) and [Additional Porous Electrode Material](#) nodes.

The c_l variable is not solved for when using the single-ion conductor charge balance model.

The c_s variable is solved for in an extra dimension, using an internal discretization in the particle dimension, not visible in the ordinary model geometry. The `cs` dependent variable, named `liion.cs_xxx` (where `xxx` is the tag of the Porous Electrode node, for instance `pce1`), can be used to set for instance concentration varying diffusion coefficients in the particle. The spatial variable of the particle is named `xs_xxx_pin1` (for instance, `xs_pce1_pin1`).

The concentration variation along the extra dimension, at a given position in the real dimension, can be accessed using the `atxd1`, `atxd2`, and `atxd3` operators. See also [Using Extra Dimensions](#) and [Plotting Results in Extra Dimensions](#) in the *COMSOL Multiphysics Reference Manual*.

The surface, center, and average values of c_s can also be evaluated in the real dimension by the variable names `liion.cs_surface`, `liion.cs_center`, and `liion.cs_average`, respectively.

Default Nodes

When this physics interface is added, these default nodes are also added to the **Model Builder** — **Separator**, **Insulation**, and **Initial Values**. Then, from the **Physics** toolbar, add other nodes that implement, for example, **Porous Electrodes** and nonporous **Electrodes**, and boundary conditions. You can also right-click **Lithium-Ion Battery** to select physics features from the context menu.



All nodes are described in [Shared Nodes for Battery Interfaces](#).

SETTINGS

The **Label** is the default physics interface name.

The **Name** is used primarily as a scope prefix for variables defined by the physics interface. Refer to such physics interface variables in expressions using the pattern `<name>.<variable_name>`. In order to distinguish between variables belonging to different physics interfaces, the `name` string must be unique. Only letters, numbers, and underscores (`_`) are permitted in the **Name** field. The first character must be a letter.

The default **Name** (for the first physics interface in the model) is `liion`.

DOMAIN SELECTION



Exclude domains that do not conduct current.

OUT-OF-PLANE THICKNESS

See [Out-of-Plane Thickness](#).

CROSS-SECTIONAL AREA

See [Cross-Sectional Area](#).

CHARGE BALANCE MODEL

The **Binary 1:1 liquid electrolyte** option uses concentrated electrolyte theory to solve for the lithium salt concentration and the potential as dependent variables in the electrolyte phase. The option is applicable to liquid (or plasticized) organic solvent-based lithium salt electrolytes.

The **Single-ion conductor** solves for the electrolyte potential by assuming that all charge in the electrolyte phase is carried by the positive lithium ions only, so that the concentration of lithium ions in the electrolyte can be assumed to be constant. The option is typically applicable to solid phase electrolytes, or electrolytes where the electrolyte conductivity is not changing as a result of the ion transport in the cell. Since the electrolyte concentration is not solved for, the single-ion conductor option reduces the computational load and complexity.

Note that the single-ion conductor option will disable all settings in domain and boundary nodes applicable to the electrolyte concentration dependent variable.

CELL SETTINGS

In this section, the **Define cell state of charge (SOC) and initial charge inventory** check box can be ticked, which activates the global [SOC and Initial Charge Distribution](#) node.

The SOC and Initial Charge Distribution node can be used to define and compute various dynamic global cell variables such as the cell capacity, state of charge (SOC) and state of health (SOH), and it also allows for specifying the initial SOC of the battery in terms of either cell voltage, cell SOC, or the individual positive and negative electrode potentials, or charge inventories.

TRANSPORT MECHANISMS

Convection can be added as an additional transport mechanism. By default, the check box **Convection** is not selected. Select the check box to enable convective transport.

Note that this section is not applicable if the **Single-ion conductor** option is selected in the **Charge Balance Model** section.

PHYSICS VS. MATERIALS REFERENCE ELECTRODE POTENTIAL

The **Physics vs. Materials Reference Electrode Potential** setting on the physics interface node can be used to combine material library data for current densities and equilibrium

potentials with an arbitrary reference electrode scale in the physics. The setting affects the electrode potentials used for model input into the materials node, as well as all equilibrium potential values output from the materials node.

Note that the setting will only impact how potentials are interpreted in communication between the physics and the **Materials** node. If the **From material** option is not in use for equilibrium potentials or electrode kinetics, the setting has no impact.

This section is available when the **Advanced Physics Options** is selected in the **Show More Options** dialog box shown when the **Show More Options** button () is clicked.

CONSISTENT STABILIZATION AND INCONSISTENT STABILIZATION

To display these sections, click the **Show More Options** button () and select **Stabilization** from the **Show More Options** dialog box. These sections are applicable only if **Convection** is selected in the **Transport Mechanisms** section. There are two consistent stabilization methods available and selected by default — **Streamline diffusion** and **Crosswind diffusion**. There is one inconsistent stabilization method, **Isotropic diffusion**, which is not selected by default.

DEPENDENT VARIABLES



This physics interface defines the following dependent variables (fields): the *electrolyte potential*, the *electrolyte salt concentration*, and the *electric potential*. The names can be changed but the names of fields and dependent variables must be unique within a model.

The electrolyte salt concentration variable is not solved for when using the Single-ion conductor charge balance model (see previous section).

Certain nodes may add additional dependent variables to the model. For example the intercalated solid lithium concentration in the [Porous Electrode](#) and [Additional Porous Electrode Material](#) nodes.



In the *COMSOL Multiphysics Reference Manual* see [Table 2-4](#) for links to common sections and [Table 2-5](#) to common feature nodes. You can also search for information: press F1 to open the **Help** window or Ctrl+F1 to open the **Documentation** window.

	<ul style="list-style-type: none"> • Introduction to Electrochemistry Modeling • About the Domain, Boundary, Edge, Point, and Pair Nodes for the Lithium-Ion Battery Interface • Shared Nodes for Battery Interfaces • Shared Physics Features in the Current Distribution Interfaces • Theory for the Lithium-Ion Battery Interface
	<ul style="list-style-type: none"> • <i>Tutorial of a Lithium-Ion Battery</i>: Application Library path Battery_Design_Module/Batteries,_Lithium-Ion/li_battery_tutorial_2d • <i>1D Isothermal Lithium-Ion Battery</i>: Application Library path Battery_Design_Module/Batteries,_Lithium-Ion/li_battery_1d • <i>Capacity Fade of a Lithium-Ion Battery</i>: Application Library path Battery_Design_Module/Batteries,_Lithium-Ion/capacity_fade

About the Domain, Boundary, Edge, Point, and Pair Nodes for the Lithium-Ion Battery Interface

The [Initial Values](#) node and [Electrode Reaction](#) are described below, the other nodes for [The Lithium-Ion Battery Interface](#) are described in [Shared Nodes for Battery Interfaces](#).

Physics nodes are available from the **Physics** ribbon toolbar (Windows users), **Physics** context menu (macOS or Linux users), or right-click to access the context menu (all users).

Initial Values

The **Initial Values** node sets the initial values for the electrolyte potential, the electric potential, and the electrolyte salt concentration.

For many electrochemical problems that use nonlinear electrode kinetics, such as Butler–Volmer kinetics, providing reasonable initial values can significantly improve solver convergence.

A good value for the **Electric potential** (SI unit: V) in electrode and porous electrode domains can usually be derived from the boundary conditions. For instance, if a boundary has been grounded or set to a cell potential, use that value as the initial value

also in the adjacent domain. For the **Electrolyte potential** (SI unit: V) a good initial value is often the negative of the equilibrium potential of the grounded electrode.

The default initial **Electrolyte salt concentration**, $1 \cdot 10^3 \text{ mol/m}^3$, is a typical value for common lithium-ion battery electrolytes. This input field is not available when using the Single-ion conductor charge balance model.

Electrode Reaction

A default **Electrode Reaction** node is added to the [Internal Electrode Surface](#) or [Electrode Surface](#) physics nodes. Use the Electrode Reaction feature to define the electrode kinetics for the charge transfer reaction that occurs between the electrolyte and a nonporous electrode. Additional subnodes are available from the context menu (right-click the parent node) or from the **Physics** toolbar, **Attributes** menu.

See the [Electrode Reaction](#) node in [Shared Physics Features in the Current Distribution Interfaces](#) for a general description of the Equilibrium Potential, Electrode Kinetics and Stoichiometric Coefficients sections.

ELECTRODE KINETICS

In addition to the kinetics expression types described in the link above, two additional kinetics expressions are available in the **Lithium-Ion Battery** interface.

The **Lithium metal** expression can be used to define a lithium metal deposition/dissolution reaction.

The **Insertion Reaction** expression can be used for modeling a heterogeneous porous electrode — that is, when the individual electrode particles are resolved in the model and defined on the boundaries to the electrolyte domain.

Lithium-Ion Battery, Deformed Geometry Model Wizard Entry

The **Lithium-Ion Battery, Deformed Geometry** () model wizard entry is a predefined multiphysics interface for time-dependent modeling of deformations that occur as a result of a deposition/dissolution processes in a lithium-ion battery, for instance lithium metal dissolution at the negative electrode of a lithium-metal battery.

By choosing the multiphysics interface, a **Lithium-Ion Battery Interface** interface and a preset instance of a **Deformed Geometry** are added to the component. **Deforming Electrode Surface** and **Nondeforming Boundary** multiphysics coupling nodes that couple electrode reactions to boundary velocities are also added by default. The predefined couplings are set up so that the deforming geometry velocity is set to the total depositing velocity on boundaries where deposition/dissolution processes occur, and zero on all other boundaries.

Note that it is also possible to extend an already existing current distribution model to include electrode deformations by manually adding a Deformed Geometry interface and the required Multiphysics coupling nodes.



- [The Lithium-Ion Battery Interface](#)
- [The Deformed Geometry Interface](#) in the *COMSOL Multiphysics Reference Manual*
- [The Multiphysics Branch](#) in the *COMSOL Multiphysics Reference Manual*
- [Deforming Electrode Surface](#) multiphysics coupling node
- [Nondeforming Boundary](#) multiphysics coupling node



Lithium Plating with Deformation: Application Library path
Battery_Design_Module/Batteries_Lithium-Ion/li_plating_with_deformation

Modeling Deformation of an Electrode Surface

The deposition rate and electrode growth velocity are defined by the Current Distribution interface by the use of an Electrode Surface (applicable to external boundaries to an Electrolyte domain) or an Internal Electrode Surface (applicable to interior boundaries between an Electrolyte and an Electrode domain).

Use the Dissolving-Depositing species section in the Electrode Surface node to specify what species are participating in the electrode reactions, and use the Electrode Reaction subnodes to specify the reaction kinetics and stoichiometry.

An arbitrary number of dissolving-depositing species can be added on an electrode surface. The surface concentration variables of the deposited species can be used to calculate the thickness of the deposited layer, and the depositing rate is used to set the boundary velocity for the deforming geometry.

Dissolution or deposition is always assumed to occur in the normal direction to an electrode boundary, with the velocity being directed into the electrolyte domain:

$$\frac{\partial \mathbf{x}}{\partial t} \cdot \mathbf{n} = v_{\text{dep, tot}} \quad (3-1)$$

where $v_{\text{dep, tot}}$ is the total growth velocity, defined as the sum of the velocity contributions for all species and electrode reactions according to:

$$v_{\text{dep, tot}} = \sum_i \frac{M_i}{\rho_i} \sum_m \frac{v_{i,m} i_{\text{loc},m}}{n_m F} \quad (3-2)$$

Where M_i (SI unit: kg/mol) is the molar mass and ρ_i (SI unit: kg/m³) the density of the species.

The boundary condition is implemented similarly to the Normal Mesh Velocity boundary node in the Deformed Geometry interface.

Tangential Velocities at the Intersection Between a Depositing and a Nondepositing Boundary

Shared points (in 2D) or edges (in 3D) between depositing and nondepositing boundaries are handled specifically in the Electrodeposition interfaces.

The deformation in the normal direction of a nondepositing boundary is set to zero at all times. However, for the deformation velocity of the shared points/boundaries in

the tangential direction of the nondepositing boundary, special conditions apply. These conditions can be derived expressions by assuming growth or dissolution to occur only in the normal direction of the depositing boundary by addition or removal of spherical particles (for example metal atoms), see [Figure 3-1](#) below.

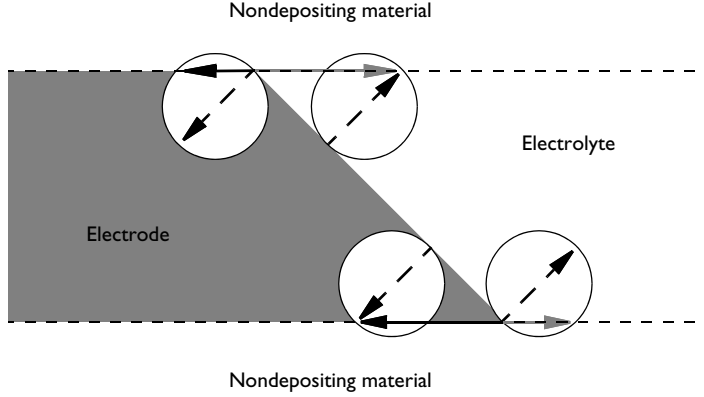

Figure 3-1: Gray/Black arrows in whole stroke indicate the tangential electrode growth/dissolution velocities, $v_{t, \text{point}}$, at the three-phase intersections between an electrolyte, a deposition or dissolution electrode and a nondepositing material. Dashed arrows are the growth or dissolution velocities, v_{dep} , based on the electrodeposition rate expressions. Note that the tangential velocities depend on both the angle between the depositing surface and the nondepositing surface, as well as the direction of the normal velocity.

In the following, the boundary tangents are denoted by \mathbf{t} (pointing from electrolyte to electrode) and the normal by \mathbf{n} (pointing in the direction out from the electrolyte domain).

If the angle between the depositing boundary and the nondepositing boundary is larger than π , the tangential velocity is set to zero:

$$\text{if } (\mathbf{t}_{\text{nondep}} \cdot \mathbf{n}_{\text{dep}} < 0) \quad v_{t, \text{point}} = 0 \quad (3-3)$$

Otherwise (that is, if the angle between the depositing boundary and the nondepositing boundary is less than π), the following expressions are used:

$$\begin{aligned} \text{Case 1:} & \quad \text{if } v_{\text{dep}} \mathbf{n}_{\text{nondep}} \cdot \mathbf{n}_{\text{dep}} > 0 & \quad v_{t, \text{point}} = v_{\text{dep}} / (\mathbf{t}_{\text{nondep}} \cdot \mathbf{n}_{\text{dep}}) \\ \text{Case 2:} & \quad \text{if } v_{\text{dep}} \mathbf{n}_{\text{nondep}} \cdot \mathbf{n}_{\text{dep}} < 0 & \quad v_{t, \text{point}} = v_{\text{dep}} (\mathbf{t}_{\text{nondep}} \cdot \mathbf{n}_{\text{dep}}) \end{aligned} \quad (3-4)$$



Note that Case 2 above results in a lower velocity in the normal direction of the depositing surface than the deposition velocity, and that this acts toward forming a $\pi/2$ angle between the depositing and the nondepositing boundary, a phenomenon observed in experiments (Ref. 1).

In the Electrodeposition Interfaces, on shared points (2D) and edges (3D) between a Nondeforming Boundary and a Deforming Electrode Surface, the velocity of the depositing boundary is set according to the expressions above.

REFERENCE

1. J. Deconinck, "Mathematical Modeling of Electrode Growth," *J. Appl. Electrochem.*, vol. 24, pp. 212–218, 1994.

The Battery with Binary Electrolyte Interface

The **Battery with Binary Electrolyte (batbe)** interface (), found under the **Electrochemistry>Battery Interfaces** branch () when adding a physics interface, is used to compute the potential and current distributions in a generic battery. Multiple intercalating electrode materials can be used, and voltage losses due to film formation on the porous electrodes can also be included.

Use this physics interface for modeling batteries with alkaline binary (1:1) electrolytes, such as NiMH or NiCd batteries.

Ohm's law is used to describe the charge transport in the electrodes, whereas concentrated electrolyte theory for an alkaline aqueous (1:1) electrolyte is used to describe charge and mass transport in the electrolyte phase. An extra dimension can be included in the porous electrode domains to describe transport of species in the solid electrode phase using Fick's law.

Dependent Variables and Extra Dimensions

Different combinations of four dependent variables are valid and solved in different domains. The four dependent variables are:

- ϕ_l , electrolyte potential
- ϕ_s , electric potential in the electrodes
- c_l , salt concentration in the electrolyte,
- c_s , intercalation concentration in the electrode particles when using the [Porous Electrode](#) and [Additional Porous Electrode Material](#) nodes.

The c_s variable is solved for in an extra dimension, using an internal discretization in the particle dimension, not visible in the ordinary model geometry. The c_s variable can be referred to as `batbe.cs_surface`, `batbe.cs_center`, or `batbe.cs_average`. The concentration variation along the extra dimension can be plotted along the solid electrode phase using the `comp1.xdim1.atxd2` operator. See also [Using Extra Dimensions](#) and [Plotting Results in Extra Dimensions](#) in the *COMSOL Multiphysics Reference Manual*.

Default Nodes

When this physics interface is added, these default nodes are also added to the **Model Builder** — **Electrolyte**, **Insulation**, **No Flux**, and **Initial Values**. Then, from the **Physics** toolbar, add other nodes that implement, for example, **Porous Electrodes** and nonporous **Electrodes**, and boundary conditions. You can also right-click **Battery with Binary Electrolyte** to select physics features from the context menu.



Except for the [Initial Values](#) and [Porous Matrix Adsorption/Desorption Reaction](#) nodes, the other nodes are described in [Shared Nodes for Battery Interfaces](#).

SETTINGS

The **Label** is the default physics interface name.

The **Name** is used primarily as a scope prefix for variables defined by the physics interface. Refer to such physics interface variables in expressions using the pattern `<name>.<variable_name>`. In order to distinguish between variables belonging to different physics interfaces, the `name` string must be unique. Only letters, numbers, and underscores (`_`) are permitted in the **Name** field. The first character must be a letter.

The default **Name** (for the first physics interface in the model) is `batbe`.

DOMAIN SELECTION



Exclude domains that do not conduct current.

OUT-OF-PLANE THICKNESS



For 2D components, the **Thickness** field (default value: 1 m) defines a parameter for the thickness of the geometry perpendicular to the two-dimensional cross-section. The value of this parameter is used, among other things, to automatically calculate the total current from the current density vector. The analogy is valid for other fluxes.

CROSS-SECTIONAL AREA

For 1D components, enter a **Cross-sectional area** A_c (SI unit: m^2) to define a parameter for the area of the geometry perpendicular to the 1D component. The value of this parameter is used, among other things, to automatically calculate the total current from the current density vector. The analogy is valid for other fluxes. The default is 1 m^2 .

SPECIES

This section contains some global settings for the electrolyte which are used in the **Insertion Reaction** type kinetics in the **Porous Electrode Reaction** node to calculate the concentration of water in the electrolyte. The default values correspond to a KOH electrolyte.

- **Electrolyte anion molar mass** M_{An^-} (SI unit: kg/mol). The default is 0.017 kg/mol.
- **Electrolyte cation molar mass** M_{Cat^+} (SI unit: kg/mol). The default is 0.0391 kg/mol.
- **Solvent molar mass** M_0 (SI unit: kg/mol). The default is 0.018 kg/mol.

CELL SETTINGS

In this section, the **Define cell state of charge (SOC) and initial charge inventory** check box can be ticked, which activates the global [SOC and Initial Charge Distribution](#) node.

The SOC and Initial Charge Distribution node can be used to define and compute various dynamic global cell variables such as the cell capacity, state of charge (SOC) and state of health (SOH), and it also allows for specifying the initial SOC of the battery in terms of either cell voltage, cell SOC, or the individual positive and negative electrode potentials, or charge inventories.

TRANSPORT MECHANISMS

Convection can be added as an additional transport mechanism. By default, the check box **Convection** is not selected. Select the check box to enable convective transport.

PHYSICS VS. MATERIALS REFERENCE ELECTRODE POTENTIAL

The **Physics vs. Materials Reference Electrode Potential** setting on the physics interface node can be used to combine material library data for current densities and equilibrium potentials with an arbitrary reference electrode scale in the physics. The setting affects

the electrode potentials used for model input into the materials node, as well as all equilibrium potential values output from the materials node.

Note that the setting will only impact how potentials are interpreted in communication between the physics and the **Materials** node. If the **From material** option is not in use for equilibrium potentials or electrode kinetics, the setting has no impact.

This section is available when the **Advanced Physics Options** is selected in the **Show More Options** dialog box shown when the **Show More Options** button () is clicked.

CONSISTENT STABILIZATION AND INCONSISTENT STABILIZATION

To display these sections, click the **Show More Options** button () and select **Stabilization** from the **Show More Options** dialog box. These sections are applicable only if **Convection** is selected in the **Transport Mechanisms** section. There are two consistent stabilization methods available and selected by default — **Streamline diffusion** and **Crosswind diffusion**. There is one inconsistent stabilization method, **Isotropic diffusion**, which is not selected by default.

DEPENDENT VARIABLES

This physics interface defines these dependent variables (fields), the **Electrolyte potential**, the **Electrolyte salt concentration** and **Electric potential**. The name can be changed but the names of fields and dependent variables must be unique within a model. The **Intercalating species concentration** in the electrode particles is another, hidden, dependent variable. This variable is solved for locally and with an independent variable for the particle radius.



In the *COMSOL Multiphysics Reference Manual* see [Table 2-4](#) for links to common sections and [Table 2-5](#) to common feature nodes. You can also search for information: press F1 to open the **Help** window or Ctrl+F1 to open the **Documentation** window.



- [Introduction to Electrochemistry Modeling](#)
- [Domain, Boundary, Edge, Point, and Pair Nodes for the Battery with Binary Electrolyte Interface](#)
- [Shared Nodes for Battery Interfaces](#)
- [Shared Physics Features in the Current Distribution Interfaces](#)
- [Theory for the Battery with Binary Electrolyte Interface](#)



1D Isothermal Nickel–Metal Hydride Battery: Application Library path
Battery_Design_Module/Batteries,_General/nimh_battery_Id

Domain, Boundary, Edge, Point, and Pair Nodes for the Battery with Binary Electrolyte Interface

The [Battery with Binary Electrolyte Interface](#) shares most of its domain, boundary, edge, point, and pair nodes with the other battery interfaces, except for [Initial Values](#) and [Porous Matrix Adsorption/Desorption Reaction](#), see [Shared Nodes for Battery Interfaces](#).

Physics nodes are available from the **Physics** ribbon toolbar (Windows users), **Physics** context menu (Mac or Linux users), or right-click to access the context menu (all users).



In general, to add a node, go to the **Physics** toolbar, no matter what operating system you are using. Subnodes are available by clicking the parent node and selecting it from the **Attributes** menu.

Initial Values

The **Initial Values** node sets the initial values for the electrolyte potential, the electric potential, and the electrolyte salt concentration.

For many electrochemical problems that use nonlinear electrode kinetics, such as Butler–Volmer kinetics, providing reasonable initial values can significantly improve solver convergence.

A good value for the **Electric potential** (SI unit: V) in electrode and porous electrode domains can usually be derived from the boundary conditions. For instance, if a boundary has been grounded or set to a cell potential, use that value as the initial value also in the adjacent domain. For the **Electrolyte potential** (SI unit: V) a good initial value is often the negative of the equilibrium potential of the grounded electrode.

The default initial **Electrolyte salt concentration**, $1 \cdot 10^3 \text{ mol/m}^3$, is a typical order of magnitude for common concentrated aqueous concentrated electrolytes.



Porous Matrix Adsorption/Desorption Reaction

Use this node to model nonfaradaic reactions on the porous electrode particle surface (for instance, hydrogen adsorption and desorption in a NiMH battery).

The **Porous Matrix Adsorption/Desorption Reaction** can be added as a subnode to a [Porous Electrode](#) parent node.

Enter values or expressions for the **Rate expression** k (SI unit: $\text{mol}/(\text{m}^2 \cdot \text{s})$) of the surface reaction and the stoichiometric **Coefficient** v_s (dimensionless) of the intercalating species for this reaction. The **Active specific surface area** a_v (SI unit: $1/\text{m}$) will only have an impact on post processing of the volumetric source variable ($\text{mol}/(\text{m}^3 \cdot \text{s})$) of the intercalating species.

The Lead–Acid Battery Interface

The **Lead–Acid Battery (leadbat)** interface (), found under the **Electrochemistry>Battery Interfaces** branch () when adding a physics interface, is used to compute the potential and current distributions in a lead–acid battery.

Ohm’s law is used to describe the charge transport in the electrodes, whereas concentrated electrolyte theory is used to describe charge and mass transport in the electrolyte phase. Mass balances for the porosities in the porous electrode domains account for changes in state of charge.

Dependent Variables

Different combinations of four dependent variables are valid and solved in different domains. The four dependent variables are:

- ϕ_l , electrolyte potential
- ϕ_s , electric potential in the electrodes
- c_l , salt concentration in the electrolyte, here H^+/SO_4^-
- ε , porosity (volume fraction of liquid electrolyte) in the [Negative Porous Electrode](#) and [Positive Porous Electrode](#) nodes.

A lead–acid cell typically consists of five parts: a positive porous electrode (PbO_2), a reservoir of electrolyte, a porous separator, a negative porous electrode (Pb), and two electrodes in contact with the positive porous electrode and negative porous electrode, respectively.

Default Nodes

When this physics interface is added, these default nodes are also added to the **Model Builder** — **Reservoir, Electric Insulation, No Flux**, and **Initial Values**. Then, from the **Physics** toolbar, add other nodes that implement, for example, **Porous Electrodes** and nonporous **Electrodes**, and boundary conditions. You can also right-click **Lead–Acid Battery** to select physics features from the context menu.

SETTINGS

The **Label** is the default physics interface name.

The **Name** is used primarily as a scope prefix for variables defined by the physics interface. Refer to such physics interface variables in expressions using the pattern `<name>.<variable_name>`. In order to distinguish between variables belonging to

different physics interfaces, the **name** string must be unique. Only letters, numbers, and underscores (`_`) are permitted in the **Name** field. The first character must be a letter.

The default **Name** (for the first physics interface in the model) is `Leadbat`.

DOMAIN SELECTION



Exclude domains that do not conduct current.

OUT-OF-PLANE THICKNESS

See [Out-of-Plane Thickness](#).

CROSS-SECTIONAL AREA

See [Cross-Sectional Area](#).

MODEL SETTINGS

The settings for the **Molar volume** and **Transport number** determine how the electrolyte velocity is calculated in the model. The default settings correspond to a lead–acid battery using sulfuric acid as electrolyte.

PHYSICS VS. MATERIALS REFERENCE ELECTRODE POTENTIAL

The **Physics vs. Materials Reference Electrode Potential** setting on the physics interface node can be used to combine material library data for current densities and equilibrium potentials with an arbitrary reference electrode scale in the physics. The setting affects the electrode potentials used for model input into the materials node, as well as all equilibrium potential values output from the materials node.



Note that the setting will only impact how potentials are interpreted in communication between the physics and the **Materials** node. If the **From material** option is not in use for equilibrium potentials or electrode kinetics, the setting has no impact.

This section is available when the **Advanced Physics Options** is selected in the **Show More Options** dialog box shown when the **Show More Options** button () is clicked.

DEPENDENT VARIABLES

This physics interface defines the following dependent variables (fields): **Electrolyte potential**, **Electrolyte salt concentration**, **Electric potential**, and **Porosity**. The names can

be changed but the names of fields and dependent variables must be unique within a model.

	<ul style="list-style-type: none">• Introduction to Electrochemistry Modeling• Domain, Boundary, Edge, Point, and Pair Nodes for the Lead–Acid Battery Interface• Shared Nodes for Battery Interfaces• Theory for the Lead–Acid Battery Interface
	<p><i>Discharge and Self-Discharge of a Lead–Acid Battery</i>: Application Library path Battery_Design_Module/Batteries,_General/pb_acid_battery_Id</p>

Domain, Boundary, Edge, Point, and Pair Nodes for the Lead–Acid Battery Interface

Physics nodes are available from the **Physics** ribbon toolbar (Windows users), **Physics** context menu (Mac or Linux users), or right-click to access the context menu (all users).

The [Lead–Acid Battery Interface](#) shares all but a few of its domain, boundary, edge, point, and pair nodes with the other battery interfaces as described in [Shared Nodes for Battery Interfaces](#).

These domain (and one boundary) nodes are unique for this physics interface and described here:

- [Initial Values](#)
- [Reservoir](#)
- [Negative Porous Electrode](#)
- [Separator](#)
- [Positive Porous Electrode](#)

	<p>In the <i>COMSOL Multiphysics Reference Manual</i>, see Table 2-4 for links to common sections and Table 2-5 to common feature nodes. You can also search for information: press F1 to open the Help window or Ctrl+F1 to open the Documentation window.</p>
---	---



In general, to add a node, go to the **Physics** toolbar, no matter what operating system you are using. Subnodes are available by clicking the parent node and selecting it from the **Attributes** menu.

Reservoir

The **Reservoir** node defines a current balance and a material balance for the salt, here H^+/SO_4^- , in a free electrolyte domain.

Use this node for domains that do not contain electrode nor separator material.

The settings of the **Electrolyte conductivity** σ_1 (SI unit: S/m) and the **Electrolyte salt diffusivity** D_1 (SI unit: m^2/s) values defines the electrolyte salt transport due to migration and diffusion.

Also convective transport can be of importance in lead–acid cells. You may set the **Mean surface-averaged velocity expression** to use analytical expressions for the velocity, based on the volume changes and the electrolyte current for either the **Negative electrode main reaction** or **Positive electrode main reaction**, or use **User defined** for an arbitrary expression for the **Velocity** \mathbf{u} (SI unit: m/s)



For the domain equations in the electrolyte, see the [Theory for the Lead–Acid Battery Interface](#).

Initial Values

The **Initial Values** node sets the initial values for the electrolyte potential, the electric potential, and the electrolyte salt concentration. Use multiple Initial Values nodes to specify different initial values in different domains.

For many electrochemical problems that use nonlinear electrode kinetics, such as Butler–Volmer kinetics, providing reasonable initial values can significantly improve solver convergence.

A good value for the **Electric potential** (SI unit: V) in electrode and porous electrode domains can usually be derived from the boundary conditions. For instance, if a boundary has been grounded or set to a cell potential, use that value as the initial value also in the adjacent domain. For the **Electrolyte potential** (SI unit: V) a good initial value is often the negative of the equilibrium potential of the grounded electrode.

The default initial **Electrolyte salt concentration**, 4900 mol/m^3 , is a typical value for a standard lead–acid battery.

The initial value of the **Porosity** (dimensionless) will set the initial electrode state of charge (SOC) in the [Negative Porous Electrode](#) and [Positive Porous Electrode](#) nodes.

Negative Porous Electrode

Use the **Negative Porous Electrode** node to set up current balances for the electrode and the pore electrolyte in the lead electrode, a material balance for the salt, and a mass balance for lead, lead oxide, and lead sulfate, using the porosity variable. In addition, the feature is also able to define the charge transfer reactions that take place in the lead electrode.

By addition of [Porous Electrode Reaction](#) subnodes, the feature is also able to define the charge transfer reactions that take place at the interface between the pore electrolyte and the porous electrode matrix. A [Porous Matrix Double-Layer Capacitance](#) and a [Porous Matrix Adsorption/Desorption Reaction](#) (for the Battery with Binary Electrolyte interface), can also be added to the node.

ELECTROLYTE PROPERTIES

See the [Reservoir](#) node for the settings of this section.

ELECTRODE PROPERTIES

The **Porosity at zero charge** ε_0 and **Porosity when fully charged** ε_{max} determines the capacity of the electrode and defines the soc variable. The **Exponent on porosity in electrode** exm defines how the effective transport parameters in the porous media depends on the porosity.

See the [Current Conductor](#) for more information about the settings of this node.



For the domain equations in the electrolyte, see the [Theory for the Lead–Acid Battery Interface](#).

Positive Porous Electrode

Use the **Positive Porous Electrode** node to set up current balances for the electrode and the pore electrolyte in the lead–oxide electrode, a material balance for the salt, and a mass balance for lead, lead oxide, and lead sulfate, using the porosity variable. In

addition, the feature is also able to define the charge transfer reactions that take place in the lead–oxide electrode.

See [Negative Porous Electrode](#) for all settings.

The difference between the Positive and Negative Porous Electrode nodes are the default values for some of the parameters, for instance of the Equilibrium Potential of the [Porous Electrode](#) subnode.

Separator

Use a **Separator** node to define a current balance in the electrolyte and a material balance for the salt, here H^+/SO_4^- . Both the material and current balances are defined for porous media.

The **Separator** node can be added from the **Electrolyte** submenu.



The **Porosity in separator** ε_{sep} (dimensionless) and the **Exponent on porosity in electrolyte** ex (dimensionless) parameters will define how the effective transport parameters of the pore electrolyte are calculated.

See also the [Reservoir](#) node.



For the domain equations in the electrolyte, see the [Theory for the Lead–Acid Battery Interface](#).

The Single Particle Battery Interface

The **Single Particle Battery (spb)** interface (), found under the **Electrochemistry>Battery Interfaces** branch () offers a simplified (compared to, for instance, the Lithium-Ion Battery interface) approach to battery modeling. The basic assumptions used are valid when current distribution effects along the depth of the porous electrodes are negligible, and when the salt concentration gradients in the electrolyte do not cause significant changes of the local conductivity of the electrolyte. The validity of the assumptions and the applicability of the single particle approach depends on various battery parameters values such as electrode porosities and thicknesses, and the electrode-electrolyte chemistry, in relation to the current load. As a rule of thumb, the Single Particle Battery interface is typically applicable to battery currents up to 1C (currents corresponding to a full charge or discharge in one hour).

Due to the lower computational load of the single particle model, the interface is suitable for models including extended cycling for, for instance, life-time simulations and thermal simulations of battery packs.

The Single Particle Battery interface models the charge distribution in a battery using one separate single particle model each for the positive and negative electrodes of the battery. The core simplification of the single particle model is to treat the large number of individual electrode particles as a single particle, assuming that the reaction current distribution across the porous electrodes is uniform. The single particle formulation accounts for solid diffusion in the electrode particles and the intercalation reaction kinetics. The ohmic potential drop in the separator is also included in the model, using a lumped solution resistance term.

The single particle model is either solved in a *global* version, where all potential dependent variables are solved globally, or in a *local* version (available in 1D, 2D, and 3D), where the variables are solved for locally in the same space dimension as the physics interface. The local version, which renders a significantly higher computational load, is suitable for modeling nonhomogeneous aging in cells where local differences in the model parameters (such as temperature) induce localized differences in the battery cell current density. It could also be used for modeling, for instance, cold start of a battery pack, where local currents will cause local heating with a positive feedback when the increased temperature raises the local electrolyte conductivity. Note that the global and local approach both require fairly low currents for the single particle approach to be valid, as described above. However, it is possible to set up the

electrolyte solution resistance as a function of the applied current in order to provide a better representation even at higher values of current.

The local model contains both global and local variables. Conversion between local and global variables are done by integrating over the total cell volume.



• [Introduction to Electrochemistry Modeling](#)

SETTINGS

The **Label** is the default physics interface name.

The **Name** is used primarily as a scope prefix for variables defined by the physics interface. Refer to such physics interface variables in expressions using the pattern `<name>.<variable_name>`. In order to distinguish between variables belonging to different physics interfaces, the `name` string must be unique. Only letters, numbers, and underscores (`_`) are permitted in the **Name** field. The first character must be a letter.

The default **Name** (for the first physics interface in the model) is `spb`.

DOMAIN SELECTION

This section is available in 1D, 2D, and 3D. The domain selection of the interface is used to calculate the battery volume.

OPERATION MODE

Use the **Operation mode** setting to specify the load of the battery. **Galvanostatic** lets you specify the **Applied current** (A). **Charge-discharge cycling** lets you specify the settings that are required to apply a charge-discharge cycle, including constant current, constant voltage and rest periods. **Potentiostatic** allows for specifying the **Applied voltage** (V) and **Circuit voltage source** lets you connect to the Electrical Circuits interface.

BATTERY SETTINGS

You may define the host capacities of the two electrodes (which in term will set the total capacity of the battery) either by the **Cell capacity** or the **Volume fractions** alternative. The for the cell capacity case, the electrode volume fractions are derived by setting explicit values for the **Battery cell capacity** in combination with the **Fraction of hosted capacity excess in negative electrode**, which can be used to specify the relation in size between the two electrodes. The fractional volumes correspond to the relative thicknesses of the porous electrodes to the total thickness of the battery cell. (The

volume fraction of the actual electrode materials within each electrode is defined in the [Positive Electrode](#) and [Negative Electrode](#) nodes.)

Use the **Model** setting (available in 1D, 2D, and 3D) to switch between a **Global** or **Local** definition of the dependent variables of the model. The difference between the global and local model is described above.

INITIAL CHARGE DISTRIBUTION

The settings of this section are used to specify the target initial solid concentration (state of charge) of the electrodes that will be solved for when the interface is solved with a Current Distribution Initialization step in the Study sequence. The initial charge distribution can then be used as initial conditions for a following Time Dependent study step in the Study.

Cell state of charge sets the concentrations based on the cell capacity and the **Initial cell state of charge** (1), **Cell voltage** sets the concentrations based on the cell capacity, and the **Electrode state of charges** lets you specify the state of charge of each electrode individually.

The **Fraction of cyclable species loss after cell assembly** can be used to reduce the amount of cyclable species in relation to the capacity specified in the Battery settings section. Use this setting to define irreversible losses of cyclable material, for instance due to solid-electrolyte-interface (SEI) formation in a lithium-ion battery.

POROUS ELECTRODE REACTION KINETICS

This section is only visible if the **Operation mode** is set to **Galvanostatic**.

In certain cases the Butler–Volmer kinetics expression, used to define the electrode reactions, can be inverted in order to define the electrode overpotential as an analytical function of the current. The advantage of this is that the potential then does not have to be solved for explicitly as a dependent variable in the model, and the nonlinearities associated with the exponential Butler–Volmer expression can be avoided. This improves computational efficiency significantly. The inverse expression can be used only when

- the anodic and cathodic transfer coefficients are both equal to 0.5
- only one porous electrode reaction is present per electrode
- no double-layer capacitance is present
- the battery is running in **Galvanostatic** mode

Enabling **Use simplified lithium insertion reaction kinetics expression for** either the **Positive electrode** or **Negative electrode** will disable any **Porous Electrode Reaction** subnodes to the corresponding electrode node and replace them with a single **Lithium Insertion Reaction** subnode.

BATTERY VOLUME

This setting is available in 0D.

CROSS-SECTIONAL AREA

This setting is available in 1D. The setting is used to calculate the battery volume. See [Cross-Sectional Area](#).

OUT-OF-PLANE THICKNESS

This setting is available in 2D. The setting is used to calculate the battery volume. See [Out-of-Plane Thickness](#).

PHYSICS VS. MATERIALS REFERENCE ELECTRODE POTENTIAL

The **Physics vs. Materials Reference Electrode Potential** setting on the physics interface node can be used to combine material library data for current densities and equilibrium potentials with an arbitrary reference electrode scale in the physics. The setting affects the electrode potentials used for model input into the materials node, as well as all equilibrium potential values output from the materials node.

Note that the setting will only impact how potentials are interpreted in communication between the physics and the **Materials** node. If the **From material** option is not in use for equilibrium potentials or electrode kinetics, the setting has no impact.

This section is available when the **Advanced Physics Options** is selected in the **Show More Options** dialog box shown when the **Show More Options** button () is clicked.

ADVANCED SETTINGS

To display this section, click the **Show More Options** button () and select **Advanced Physics Options** in the **Show More Options** dialog box. In this section you can set the **Initial values** of some of the dependent variables in the interface. The settings are normally only needed if the model is solved without an initial Current Distribution Initialization study step in the Study sequence. Also, you can set the check box **Exclude heat source variable from Jacobian**. The check box is selected by default in 3D and is not selected by default in other space dimensions. Note that this check box is relevant only when coupling to heat transfer interfaces.

DISCRETIZATION

The section is only available in 1D, 2D, and 3D. The chosen **Element order** will be used by the dependent variables when the **Model** is set to **Local**.



Single Particle Model of a Lithium-Ion Battery: Application Library
path **Battery_Design_Module/Batteries,_Lithium-Ion/**
li_battery_single_particle

Model Tree Nodes for the Single Particle Battery Interface

When this physics interface is added, these default nodes are also added to the **Model Builder** — **Electrolyte and Separator**, **Positive Electrode**, and **Negative Electrode**. Only one instance each of these nodes can be present in the interface, so you cannot add additional instances of these nodes, and they cannot be deleted. The selection of these nodes are locked to the parent selection of the physics interface.

Electrolyte and Separator

The settings of this node are used to define the lumped electrolyte conductivity and the cross-sectional area of the single particle model. For the conductivity, you may either specify user-defined settings or make use of the Materials node and the Battery Materials library.

The settings of the Model Inputs are used to specify the electrolyte salt concentration when you use the Materials node to provide the electrolyte conductivity.

The **Electrolyte solution resistance** setting may either be **Based on thickness and conductivity** or **User defined**. The first option will calculate the lumped electrolyte resistance based on the **Separator thickness** (m) and the **Electrolyte conductivity** (S/m), **Effective conductivity correction** (1) and the **Electrolyte volume fraction in separator** (1). The **Fraction of separator resistance value** (1) is used to correct for the fact that the lumped effective electrolyte thickness is thicker than the separator due to distribution effects in the porous electrodes. It is typically a value larger than 1.

The **Separator thickness** setting can also be used in combination with the parameters below to calculate the cross-sectional area of the separator in the battery, and it may also be used to compute to lumped solution resistance.

The **Separator cross-sectional area** setting may either be **Based on thickness and volume fraction** of **User defined**. The first option will calculate the area based on the **Separator thickness** and the **Separator volume fraction in battery** (1).

Positive Electrode

The settings of this node are used to define the properties of the positive electrode material.

Subnodes (one [Porous Electrode Reaction](#) is added by default) are used to define the properties of the electrochemical reactions in the electrode. You may also add additional [Porous Electrode Reaction](#) and [Porous Matrix Double-Layer Capacitance](#) subnodes. These subnodes are available by clicking the parent node and selecting it from the **Attributes** menu, or by right-clicking the parent node.

If the **Use simplified reaction kinetics expression for** check boxes for the **Positive electrode** has been enabled in the [Porous Electrode Reaction Kinetics](#) section on the top-node, only one single [Lithium Insertion Reaction](#) is present, and it cannot be deleted.

ELECTRODE SETTINGS

The **Solid volume fraction** (1) is used to calculate the electrode surface area of the electrode. If the battery capacity is defined by **Volume fractions** on the parent interface node, this setting will also have an impact on the resulting electrode host capacity.

PARTICLE INTERCALATION

This section handles the settings for the intercalating species in the electrode particles.

For the remaining settings of this section see the [Porous Electrode](#) node in the Lithium-Ion Battery and Battery with Binary Electrolyte interfaces.

Negative Electrode

The settings of this node are used to define the properties of the negative electrode material. The settings are identical to the [Positive Electrode](#).



Lithium Insertion Reaction

This node is available as a subnode to the [Positive Electrode](#) and [Negative Electrode](#) nodes.

The node is only present when the **Use simplified lithium insertion reaction kinetics expression for** check boxes for either the **Positive electrode** or **Negative electrode** has been enabled in the [Porous Electrode Reaction Kinetics](#) section on the top node.

For the rest of the settings of this node, see the [Insertion Reaction](#).

The Lumped Battery Interface

The **Lumped Battery (lb)** interface () , found under the **Electrochemistry>Battery Interfaces** branch () offers a simplified (compared to, for instance, the Lithium-Ion Battery or the Single Particle Battery interface) approach to battery modeling.

Instead of differentiating between the various processes in the negative and positive electrodes, and the electrolyte, the Lumped Battery interface makes use of a small set of lumped parameters for adding contributions for the sum of all voltage losses in the battery, stemming from ohmic resistances and (optionally) charge transfer and/or diffusion processes. The applicability of the lumped approach depends on various internal battery parameters such as the combination of electrode and electrolyte materials, porosities, and layer thicknesses, and the electrode-electrolyte chemistry, in relation to the current load.

Due to the limited set of parameters needed, the interface is suitable when only little information is available about the internal structure, or chemistry, of a battery. Heat sources are calculated automatically by the physics interface and can be used together with a Heat Transfer interface for thermal simulations.

The Lumped Battery interface is based on a similar set of equations as [The Single Particle Battery Interface](#), with additional simplifications based on the assumption that the activation and concentration overpotentials can be attributed to one electrode only.

The interface solves for the battery state of charge as a dependent variable. If concentration overpotentials are included in the model and calculated based on diffusion in an idealized particle, the state of charge variable is solved for in an extra dimension, representing a generalized electrode particle (or electrolyte diffusion layer) wherein concentration overpotentials occur due to limited mass transport of a reacting species to the electrode-electrolyte interface, where the charge transfer reaction takes place.

The lumped model is either solved in a *global* version, where the soc dependent variable and diffusion extra dimension are defined globally, or in a *local* version (available in 1D, 2D, and 3D), where the variables are solved for locally in the same space dimension as the physics interface. The local version, which renders a significantly higher computational load, is suitable for modeling inhomogeneous cells where local differences in the model parameters (such as temperature dependent resistances) induce localized differences in the battery cell current density. One example could be cold start of a battery pack, where local currents will cause local

heating with a positive feedback when the increased temperature raises the local electrolyte conductivity.

The local model contains both global and local variables. Conversion between local and global variables are done by integrating over the total cell volume.



• [Introduction to Electrochemistry Modeling](#)



Parameter Estimation of a Time-Dependent Lumped Battery Model:
Application Library path **Battery_Design_Module/Batteries_Lithium-Ion/li_battery_1d**

SETTINGS

The **Label** is the default physics interface name.

The **Name** is used primarily as a scope prefix for variables defined by the physics interface. Refer to such physics interface variables in expressions using the pattern `<name>.<variable_name>`. In order to distinguish between variables belonging to different physics interfaces, the `name` string must be unique. Only letters, numbers, and underscores (`_`) are permitted in the **Name** field. The first character must be a letter.

The default **Name** (for the first physics interface in the model) is `1b`

DOMAIN SELECTION

This section is available in 1D, 2D, and 3D. The domain selection of the interface is used to calculate the battery volume.

OPERATION MODE

Use the **Operation mode** setting to specify the load of the battery.

Galvanostatic lets you specify the **Applied current** (A). This can be used to specify the battery current load. (The expression may be time-dependent using the character `t` for time.). **Charge-discharge cycling** mode lets you specify the settings that are required to apply a charge-discharge cycle, including constant current, constant voltage and rest periods. **Potentiostatic** allows for specifying the **Applied voltage** (V) and **Power** allows for specifying the **Applied power** (W). **Circuit voltage source** lets you connect to the Electrical Circuits interface.

BATTERY SETTINGS

The **Initial battery cell capacity** (C) specifies the battery capacity.

The **Initial cell state of charge** (1) specifies the state of charge of the battery when the simulation starts.

Use the **Model** setting (available in 1D, 2D, and 3D) to switch between a **Global** or **Local** definition of the dependent variables of the model. The difference between the global and local model is described above.

HARMONIC PERTURBATION

To display this section, click the **Show More Options** button () and select **Advanced Physics Options**.

Use **Perturbation amplitude** (A) to specify the perturbation on the applied battery current. This section is applicable only for Frequency-Domain Perturbation studies using the **Galvanostatic** operation mode.

BATTERY VOLUME

A battery volume variable is used in order to calculate a battery heat source variable ($1b.Qh$, SI-unit: W/m^3) from the lumped model. The heat source may typically be used for thermal simulations in combination with a Heat Transfer interface.

A **Battery Volume** (m^3) setting is available in 0D.

In 1D, the selected domain length, in combination with the **Cross-Sectional Area** is used for calculating the volume.

In 2D, the selected domain area, in combination with the **Out-of-Plane Thickness** is used for calculating the volume.

In 3D, the battery volume equals the volume of the selected domain.

ADVANCED SETTINGS

To display this section, click the **Show More Options** button () and select **Advanced Physics Options**.

In this section you can set the check box **Exclude heat source variable from Jacobian**. The check box is selected by default in 3D and is not selected by default in other space dimensions. Note that this check box is relevant only when coupling to heat transfer interfaces. Excluding the heat source from the Jacobian may decrease the computation time.

Model Tree Nodes for the Lumped Battery Interface

When this physics interface is added, these default nodes are also added to the **Model Builder** — **Cell Equilibrium Potential** and **Voltage Losses**. Only one instance each of these nodes can be present in the interface, so you cannot add additional instances of these nodes, and they cannot be deleted. The selection of these nodes are locked to the parent selection of the physics interface.

Cell Equilibrium Potential

The settings of this node define the thermodynamics of the battery.

Specify the **Open circuit voltage at reference temperature** (V) and **Temperature derivative of open circuit voltage** (V/K) as a function of state of charge, in the corresponding tables. Linear interpolation between the provided values, as well as linear extrapolation outside the range of values will be used. Note, the temperature derivative of open circuit voltage data is used to calculate the temperature dependence of the open circuit voltage and in the calculation of the reversible (entropic) contribution and heat of mixing contribution to the total heat source.

Also, set the **Reference temperature** (K) in this node.

Voltage Losses

The settings of this node define the voltage losses that occur in the battery when a current is applied.

OHMIC OVERPOTENTIAL

The **Ohmic Overpotential** varies linearly with the battery current. The value of the **Ohmic overpotential at IC** (V) specifies the value of ohmic voltage loss for a battery current of 1C. The 1C current equals the battery capacity value, set at the interface top node, divided by 1 h.

ACTIVATION OVERPOTENTIAL

Enable **Include activation overpotential** to add a voltage loss related to the charge transfer processes in the battery. A **Dimensionless charge exchange current** value of 1 corresponds to an activation overpotential of approximately 25 mV for a battery current of 1C. For higher currents the activation overpotential varies approximately logarithmically with the current magnitude.

Enable **Include double-layer capacitance** to include capacitive charging of the double layer over which the charge transfer processes occur. These effects typically occur on a time scale of tens of microseconds, or less.

CONCENTRATION OVERPOTENTIAL

Enable **Include concentration overpotential** to add a voltage loss related to mass transport (diffusion) processes in the battery. Two different concentration overpotential models are available: **Particle diffusion** and **Resistor-Capacitor pair**.

For Particle diffusion, the magnitude of the concentration overpotential will depend both on the **Open circuit voltage**, specified on the [Cell Equilibrium Potential](#) node, and the cycling history of the battery. The value of the **Diffusion time constant** is related to the relaxation time of the battery for reaching steady state at open circuit. Increasing the value of the diffusion time constant will generally increase the concentration overpotential.

For the Resistor-Capacitor pair option, the concentration overpotential will depend both on the **RC time constant** and the **RC potential at IC** parameters. The latter parameter equals the steady-state overpotential that the RC component will approach for a IC constant load. (Note that the Particle diffusion overpotential will never reach a steady state value for a constant load.)

PARTICLE DISCRETIZATION

This section is only available when **Include concentration overpotential** is enabled, using a **Particle diffusion** model. The section handles the settings for how the extra dimension used for solving the diffusion equation is defined. For the settings of this section, see the [Particle Intercalation](#) node in the Lithium-Ion Battery and Battery with Binary Electrolyte interfaces.

Capacity Loss

The settings of this node define the capacity loss that occurs in the battery due to parasitic reactions.

CAPACITY LOSS

The **Loss kinetics** can be specified by either using a **Built in** expression or an **User defined** expression. The **Built in** option calculates a loss current based on a **Calendar aging time constant** that defines the rate of the parasitic reactions, and dimensionless aging factors dependent on **Voltage**, **Current**, **Aging history**, and **Temperature**, respectively. The loss

current is used to calculate the accumulated capacity loss corresponding to the parasitic reactions.

All aging factors having the value of 1 would result in a constant capacity fade, starting from initial time, reaching 0 remaining cell capacity when the time is equal to the **Calendar aging time constant**, independent of battery SOC, capacity throughput, aging history and temperature.

Enable **Voltage** to specify the **Offset potential** and **Transfer coefficient** parameters, that relate how the rate of the parasitic reactions changes when the battery voltage deviates from the average open circuit voltage. In many battery systems, it is seen that high state of charge values (typically resulting in high battery voltage) accelerate capacity loss.

Battery lifetime is closely related to the amount of cycled equivalent full cycles. Enable **Current** to specify the **Cycling capacity loss factor** parameter, which defines the additional capacity loss induced by cycling. For example, a value of $2 \cdot 10^{-4}$ (with all other aging factors set to 1) would result in an additional capacity fade of 20% for a cycled amount corresponding to 1000 cycles of the initial capacity.

Enable **Aging history** to define a decelerating aging rate. Specify the **Decelerating aging factor** that defines how many times the capacity loss rate will have been reduced when all capacity has been lost.

Enable **Temperature** to specify the **Activation energy** and **Reference temperature** parameters, in order to calculate a temperature-dependent aging factor defined using an Arrhenius expression.

The **User defined** option of **Loss kinetics** can be used to explicitly specify the **Loss current**.

Short Circuit

SHORT-CIRCUIT CONDUCTANCE

Use this setting to define the short-circuit scenario inside a lumped battery. Define the **Short-circuit conductance** G_{short} in S to evaluate short-circuit currents and corresponding heat source. This node can be used to model self-discharge in a lumped battery, along with other short-circuit scenarios.

The Battery Equivalent Circuit Model Wizard Entry

The **Battery Equivalent Circuit** model wizard entry can be used to define a battery model based on an arbitrary number of electrical circuit elements. Models created with the Battery Equivalent Circuit can typically be used to monitor the state of charge and the voltage response of a battery during a load cycle.

When selecting the Battery Equivalent Circuit in the Model Wizard, this adds an **Electrical Circuit** interface to the model, including a number of predefined circuit elements that are used to define the open circuit voltage, the load current and an internal resistance. Additional circuit elements such as resistors, capacitors, and inductors may be added by the user.

See also [The Electrical Circuit Interface](#).

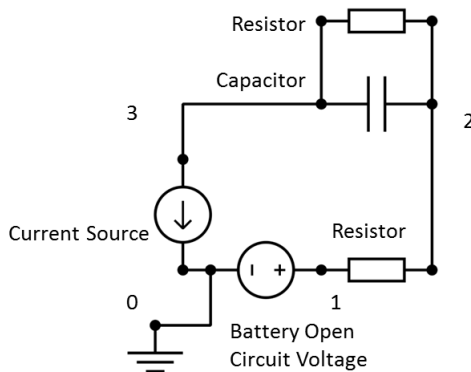



Figure 3-2: Circuit elements and corresponding node numbers in the Electrical Circuit interface added by the Battery Equivalent Circuit entry in the Model Wizard.



An Equivalent Circuit Model for a Nickel–Metal Hydride Battery.
Application Library path **Battery_Design_Module/Batteries_General/nimh_equivalent_circuit_battery**

The Battery Pack Interface

The **Battery Pack (bp)** interface () , found under the **Electrochemistry>Battery Interfaces** branch () offers a one-to-many approach for setting up multiple battery cell models, and for connecting them in a 3D geometry. The interface is typically used together with a heat transfer interface for modeling of thermal pack management and thermal runaway propagation problems.

The interface defines two types of domain nodes by default — **Batteries** and **Current Conductors**, which are used to define the active battery cells and the electrical wiring (current collectors, feeders, and busbars, and so on) of the pack, respectively. The location of the interconnects between the batteries and the current conductors are defined by the **Negative Connectors** and **Positive Connectors** boundary nodes, which are always also present by default.

The battery cell models are defined similarly as for [The Lumped Battery Interface](#). All battery models defined by a Battery Pack interface share the same parameter settings. Modeling of packs with cells different individual parameter settings may be accomplished by coupling multiple separate Battery Pack and/or Lumped Battery interfaces together.

Individual cell models are defined automatically on disjoint sets of battery domains and each individual battery current load is set implicitly via potential constraints at the negative/positive connector boundaries between the battery domains and the current conductor domains. The load of the complete battery pack is defined by boundary conditions on the external boundaries to the current conductor domains, which may be added as subnodes to the **Current Conductors** node.

The Battery Pack interface also defines a heat source that may be coupled to a Heat Transfer interface, using the **Electrochemical Heating** node, for modeling battery cooling and thermal management. The interface is available in 3D only.



- [Introduction to Electrochemistry Modeling](#)
 - [The Lumped Battery Interface](#)
-

SETTINGS

The **Label** is the default physics interface name.

The **Name** is used primarily as a scope prefix for variables defined by the physics interface. Refer to such physics interface variables in expressions using the pattern `<name>.<variable_name>`. In order to distinguish between variables belonging to different physics interfaces, the `name` string must be unique. Only letters, numbers, and underscores (`_`) are permitted in the **Name** field. The first character must be a letter.

The default **Name** (for the first physics interface in the model) is `bp`.

DOMAIN SELECTION



Exclude domains that neither conduct current nor are active battery cells.

ADVANCED SETTINGS

To display this section, click the **Show More Options** button () and select **Advanced Physics Options**.

In this section you can set the check box **Exclude heat source variable from Jacobian**. The check box is selected by default. Note that this check box is relevant only when coupling to heat transfer interfaces. Excluding the heat source from the Jacobian may decrease the computation time.



Thermal Distribution in a Pack of Cylindrical Batteries: Application
Library path **Battery_Design_Module/Thermal_Management/**
battery_pack_6s2p

Model Tree Nodes for the Battery Pack Interface

When this physics interface is added, these default nodes are also added to the **Model Builder** — **Batteries**, **Current Conductors**, **Negative Connectors**, and **Positive Connectors**. Only one instance each of these nodes can be present in the interface, so you cannot add additional instances of these nodes, and they cannot be deleted.

Batteries

The node defines the individual battery cells the battery pack. One battery cell model is defined per each disjoint domain group in the geometry selection.

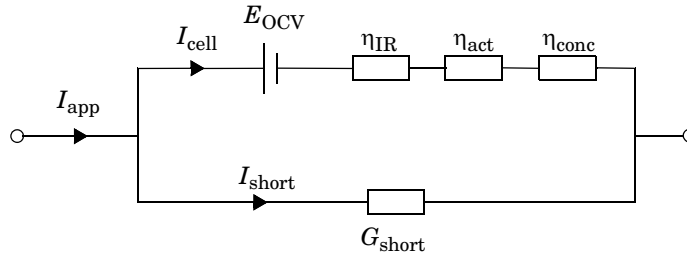

Figure 3-3: Circuit diagram depicting the available elements of the individual battery models, defined for each disjoint domain group by the Batteries node (and child nodes). The circles on the left and right hand sides represent the positive and negative cell terminals, respectively. The directions of I_{cell} and I_{app} correspond to the situation during charging.

Two subnodes are also added by default — [Cell Equilibrium Potential](#) and [Voltage Losses](#). Only one instance each of these subnodes can be present in the interface, so you cannot add additional instances of these subnodes, and they cannot be deleted. The selection of these subnodes are locked to the selection of the Batteries node.

Additional subnodes such as [Thermal Event](#), [Capacity Loss](#), and [Short Circuit](#) can be also be added. The [Capacity Loss](#) subnode is a singleton node and the selection is locked to the selection of the Batteries node. The [Short Circuit](#) subnode is also a singleton node with a default empty selection, that can be set to any of the domains of the Batteries node. The settings of the both these subnodes are similar to the nodes in [The Lumped Battery Interface](#).

BATTERY PACK SETTINGS

Enable **Specify battery properties from materials** to automatically set up the following from the **Materials** node: the **Initial battery cell capacity**, all open circuit voltage related properties on the [Cell Equilibrium Potential](#) node (the **Open circuit voltage at reference temperature**, the **Temperature derivative of open circuit voltage** and the **Reference temperature**), and all overpotential related properties on the [Voltage Losses](#) node (the **Ohmic overpotential at IC**, the **Dimensionless charge exchange current**, and either the **Diffusion time constant** or the **RC time constant** and the **RC potential at IC**).

The **Initial battery cell capacity** (C) specifies the initial battery cell capacity.

The **Initial pack state of charge** (1) specifies the state of charge of the battery pack when the simulation starts.

On the **Voltage Losses** node, if **Specify battery properties from materials** is enabled and the concentration overpotential is enabled and set to **Particle diffusion**, the **Heat of mixing** contribution can either be included or excluded. Enabling the **Heat of mixing**, requires the **Particle material** to be set. The **Open circuit voltage at reference temperature**, the **Temperature derivative of open circuit voltage** are automatically set up from the **Materials** node. Note that if **Specify battery properties from materials** is not enabled and the concentration overpotential is enabled and set to **Particle diffusion**, the heat of mixing contribution is always included.

Thermal Event

The settings of this subnode set up an event-based heat source in a battery pack. The node is typically used to study cell-to-cell propagation of thermal runaway phenomena, where the time-dependent heat source triggered by the event stems from exothermic reactions due to (irreversible) decomposition of the electrolyte and/or electrode materials. Multiple thermal event nodes may be used to model the effect of heat sources from different reactions. The selection of this subnode applies by default to the selection of the Batteries node, but may be altered.

The thermal event is triggered by an **Event condition**, which could be when either the maximum or average cell temperature exceeds a corresponding trigger temperature, or if the simulated time exceeds the explicit time that is specified. The event can only be triggered once per battery cell. The **Heat source after event** is to be specified as a function of time elapsed after triggering of the event, and this can be done using options of **Local table**, **User defined**, or **From definitions**. After the event has been triggered, the thermal event heat source is added to the total sum of all heat sources for the battery cell.

In addition, the event may also induce changes in the ohmic overpotentials (internal resistance) of the battery cells and/or induce cell short circuits. **Add ohmic overpotential after event** can be used to specify **Ohmic overpotential at IC after event** (V), and the specified value will be added to the corresponding value specified in the **Voltage Losses** subnode after the event. **Add short circuit after event** can be used to specify **Short circuit conductance after event** (S), and the specified value will add a short circuiting current after the event in a similar way as the **Short Circuit** node. If a **Short Circuit** subnode is already present, the event-induced short circuit current will be added in parallel.

Current Conductors

The settings of this node define the current conductor domains in a battery pack. When this node is added, these default subnodes are also added — [Initial Values](#) and [Insulation](#).

ELECTRICAL CONDUCTIVITY

The **Electrical conductivity** (S/m) specifies the electrical conductivity of the current conductors or feeders in the battery pack.

All the boundary condition subnodes of this node are similar to those described for the Current Distribution interfaces. See boundary nodes described in [Shared Nodes for Battery Interfaces](#).

Initial Values

This subnode sets up the initial value of the **Electric Potential** (V).

Negative Connectors

The settings of this node define the negative connector boundaries between the battery domains and current conductor domains of a battery pack.

CONTACT RESISTANCE

Enabling **Include contact resistance** allows for a contact resistance ($\Omega\cdot\text{m}^2$) to be specified.

Positive Connectors

The settings of this node define the positive connector boundaries between the battery domains and current conductor domains of a battery pack.

CONTACT RESISTANCE

Enabling **Include contact resistance** allows for a contact resistance ($\Omega\cdot\text{m}^2$) to be specified.

Shared Nodes for Battery Interfaces

The [Battery with Binary Electrolyte Interface](#), [The Lithium-Ion Battery Interface](#), and [The Lead–Acid Battery Interface](#) share many domain, boundary, edge, point, and pair nodes.

The following domain and boundary nodes are described in this section and available for the interfaces as noted (listed in alphabetical order):

- [Additional Porous Electrode Material](#)
- [Concentration](#)
- [Electrolyte](#)
- [Flux](#)
- [SOC and Initial Charge Distribution](#)
- [Negative Electrode Selection](#)
- [No Flux](#)
- [Porous Conductive Binder](#)
- [Porous Electrode](#)
- [Porous Electrode Reaction](#)
- [Positive Electrode Selection](#)
- [Reaction Source](#)
- [Separator](#)

These shared nodes are described for the Current Distribution interfaces (listed in alphabetical order).

- Double-Layer Capacitance
- Electric Ground
- Electric Potential
- Electric Reference Potential
- Current Conductor
- Electrode Current
- Electrode Current Density
- Electrode Current Source
- Electrode-Electrolyte Boundary Interface
- Electrode Potential
- Electrode Power
- Electrode Reaction
- Electrode Surface
- Electrolyte Current Source
- Electrolyte Current Density
- Electrolyte Potential
- Harmonic Perturbation
- Insulation
- Internal Electrode Surface
- Porous Matrix Double-Layer Capacitance
- Reference Electrode
- Symmetry



In the *COMSOL Multiphysics Reference Manual* see [Table 2-4](#) for links to common sections and [Table 2-5](#) to common feature nodes. You can also search for information: press F1 to open the **Help** window or Ctrl+F1 to open the **Documentation** window.

Electrolyte

Use the **Electrolyte** node to define an electrolyte domain that only conducts current in the ion conducting phase. The combined charge and mass transfer in the electrolyte is defined by the node.

The **Convection** section is available when the **Convection** check box is selected on the interface top node. The **Velocity field \mathbf{u}** (SI unit: m/s) of the solvent is specified as a feature input. Select the source of velocity field from the velocity field list.

The **Electrolyte conductivity**, σ_l (SI unit: S/m), parameter will define how the current in the domain depends on the gradient of the potential and the concentration variable, the **Diffusion coefficient** (SI unit: m^2/s), defines how the flux of ions relates to concentration gradients, and the **Transport number t_+** (also called transference

number), which by default is set to 0.363 (a typical value for Li-ion batteries), specifies how much of the charge is carried by the positive ions.

Use the **Activity dependence** on concentration parameter to modify the ion activity. The default is 1 (dimensionless).

For the Battery with Binary Electrolyte interface, also enter the **Solution density** ρ (SI unit: kg/m^3) (the electrolyte density). The default is $1293 \text{ kg}/\text{m}^3$ (A typical value for a KOH electrolyte).

Note that the electrolyte in this case does not refer to the pore electrolyte in porous electrodes (which should be defined by a [Porous Electrode](#) node instead). For porous separators, use the [Separator](#) instead.



For the domain equations in the electrolyte, see the [Theory for the Battery with Binary Electrolyte Interface](#) and [Theory for the Lithium-Ion Battery Interface](#) sections.

Separator

Use a **Separator** node to model electrolyte charge and mass transport in an electronically isolating porous matrix. Use correction factors to account for the lowered diffusion coefficients in the electrolyte and the lowered conductivities of the electrode, due to the lower volume fractions of the electrolyte phase and the tortuosity of the porous matrix.

See also the [Electrolyte](#) node for more information about some of the settings of this node.

POROUS MATRIX PROPERTIES

The **Electrolyte volume fraction** ε_1 is used in the mass balance equations to account for the available liquid volume. These parameter values may also be used by the **Effective Transport Parameter Correction** (next section). Similarly, the **Electrolyte tortuosity** τ_1 parameter may also be used by the **Effective Transport Parameter Correction** (next section). Select either **Isotropic** to define a scalar value, or **Diagonal** and **Symmetric** to define anisotropic tensor values. The default is **Isotropic 1**.

EFFECTIVE TRANSPORT PARAMETER CORRECTION

Use the settings of this section to calculate effective transport parameters for the electrode and the electrolyte if your corresponding parameter values refer to nonporous media.

DISSOLVING-DEPOSITING SPECIES

See the [Porous Electrode](#) node for more information about some of the settings of this node.

Porous Electrode

The **Porous Electrode** node sets up current balances for a porous electrode matrix and a pore electrolyte, as well as the mass balance for the pore electrolyte in a domain. The node may also set up a mass balance of an intercalating species in the electrode particles. By addition of [Porous Electrode Reaction](#) subnodes, the feature is also able to define the charge transfer reactions that take place at the interface between the pore electrolyte and the porous electrode matrix. A [Porous Matrix Double-Layer Capacitance](#) and a [Porous Matrix Adsorption/Desorption Reaction](#) (for the Battery with Binary Electrolyte interface), can also be added to the node.

Use correction factors to account for the lowered diffusion coefficients in the electrolyte and the lowered conductivities of the electrode, due to the lower volume fractions of each phase and the tortuosity of the porous matrix.

See also the [Electrolyte](#) and [Current Conductor](#) nodes for more information about the settings of this node.

ELECTROLYTE PROPERTIES

See the [Electrolyte](#) node for more information about the settings of this section.

ELECTRODE PROPERTIES

See the [Current Conductor](#) node for more information about the settings of this section

PARTICLE PROPERTIES

By selecting **Intercalating particles**, the node adds a mass balance and the corresponding dependent variables for solving for an intercalating concentration. The settings related to the intercalation are set on the [Particle Intercalation](#) child node.

POROUS MATRIX PROPERTIES

The **Electrode volume fraction** ε_s and **Electrolyte volume fraction** ε_1 parameters are used in the mass balance equations to account for the available volume of each phase, and also in the **Porous Electrode Reaction** to calculate the surface area. The default value for each fraction is 0.4. These parameter values may also be used by the **Effective Transport Parameter Correction** (next section). Similarly, the **Electrode tortuosity** τ_s and **Electrolyte tortuosity** τ_1 parameters may also be used by the **Effective Transport Parameter Correction** (next section). Select either **Isotropic** to define a scalar value, or **Diagonal** and **Symmetric** to define anisotropic tensor values. The default is **Isotropic 1**.

EFFECTIVE TRANSPORT PARAMETER CORRECTION

Use the settings of this section to calculate effective transport parameters for the electrode and the electrolyte if your corresponding parameter values refer to nonporous media.

DISSOLVING-DEPOSITING SPECIES

Use the settings of this section to define species that participate in dissolution-deposition electrode reactions within the porous electrode, for instance, metal deposition/dissolution or oxide formation.

Use the **Add** (+) and **Delete** () buttons as needed in the tables to control the number of species.

Dependent variables for the volumetric molar concentration are added for each dissolving-depositing species. These variables can be used to keep track of the amount of reacted material in the porous electrode. The total molar dissolution/deposition rate depends on the reaction rates and stoichiometry, defined in the **Porous Electrode Reaction** subnodes.

The **Density** and **Molar mass** determine the electrode growth velocity and the resulting dissolved/deposited layer thickness. By multiplying by the electrode surface area (in the case of multiple electrode reaction the average surface area is used), the change in electrode and electrolyte volume fractions can be also be calculated. By use of the **Add volume change to electrode volume fraction** (not available for Separator node) and **Subtract volume change from electrolyte volume fraction** check boxes you may define how these volume changes should be included in the model.

Thickness variables, based on the surface area, are also defined that you for instance can use to couple to the Film Resistance (see below).

FILM RESISTANCE

A film resistance is typically used for modeling the build-up of a SEI (solid electrolyte interface) layer in lithium-ion battery graphite electrodes. See also the [Electrode Surface](#) node.

Particle Intercalation

This node is available as a subnode to the [Porous Electrode](#) and [Additional Porous Electrode Material](#) nodes in [The Lithium-Ion Battery Interface](#) and [The Battery with Binary Electrolyte Interface](#) interfaces. The node is only visible if **Intercalating Particles** has been selected on the parent node.

SPECIES SETTINGS

Specify the initial concentration of the intercalating species (that is, the initial charge level of the electrode) either as a **Initial species concentration** $c_{s,init}$ (SI unit: mol/m³) or an **Initial electrode potential**.

The **Initial electrode potential** E_{init} (SI unit: V) is used as argument to the **Equilibrium concentration** function, which may be specified either **From material** or **User defined**.

Note that if the [SOC and Initial Charge Distribution](#) is active in the model, only the **Equilibrium concentration** setting is active, and E_{init} is defined internally based on the settings in the [SOC and Initial Charge Distribution](#) node.

The **Maximum species concentration** $c_{s,max}$ (SI unit: mol/m³) defines the maximum possible concentration of the intercalated concentration. The value is used by [Porous Electrode Reaction](#) when the **Kinetic expression type** has been set to **Lithium Insertion**. If the [SOC and Initial Charge Distribution](#) is active in the model this concentration is also used to compute the electrode host capacity.

PARTICLE TRANSPORT PROPERTIES

The **Species concentration transport model** specifies the diffusion model for the intercalating species in the electrode particles.

Fick's law and **Baker-Verbrugge** both add an extra dimension, defined on the porous electrode domain, within which a diffusion equation is applied in order to solve for the concentration distribution along the depth within a single particle of the electrode.

The transport in the extra dimension is defined by the **Intercalation diffusivity** D_s (SI unit: m²/s). The **From material** option of D_s does not support concentration varying diffusion coefficients. The **User defined** option of D_s can be used to set up concentration varying diffusion coefficients, by specifying the diffusivity as a function

of the solid lithium concentration in the electrode particles, c_s . Refer to *Dependent Variables and Extra Dimensions* in [The Lithium-Ion Battery Interface](#) (or *Dependent Variables and Extra Dimensions* in [The Battery with Binary Electrolyte Interface](#)) for a discussion on the variable name to be used for the c_s dependent variable.

Fick's law defines the molecular flux of the intercalated species as the product of the diffusion coefficient and the concentration gradient. The **Baker-Verbrugge** models adds a correction to the diffusion coefficient based on the **Equilibrium potential**, E_{eq} , of the intercalation reaction. This potential is defined in the **Equilibrium Potential** section below. Generally, the Baker-Verbrugge model is better at capturing state-of-charge dependent transport rates and staging phenomena, whereas Fick's law may be numerically more stable. Note that the parameter values of the diffusivity from the material library generally have been estimated assuming Fick's law and may have to be reduced when switching to Baker-Verbrugge.

Use **No spatial gradients** to assume a constant concentration along the depth of the particle. **No spatial gradients** significantly reduces the computational load of the model.

The geometry in the extra dimension is one dimensional and is defined by the **Particle type** (**Spheres** (the default), **Cylinders**, or **Flakes**) together with the **Particle mean center-surface distance** r_p .

OPERATIONAL POTENTIAL LIMITS

Set **Maximum** and the **Minimum operational potential**, E_{max} and E_{min} , to specify the potential window of the electrode. These values are used together with the [SOC and Initial Charge Distribution](#) node to define and compute dynamic global cell variables.

PARTICLE DISCRETIZATION

This section is not available if **No spatial gradients** is selected under **Particle Transport Settings**.

Use these settings to control the **Distribution** of the mesh and the **Element order** of the extra particle dimension.

The predefined distributions **Square** or **Cubic root sequence** create mesh distributions with a denser mesh toward the particle surface.

The **Use fast assembly in particle dimension** option enables an alternative method for assembling of the diffusion equation in the particle dimension that may decrease computation time when the number of mesh elements in the battery cell dimension is of the same order of magnitude as the number of elements in the particle dimension

(this is typically the case for 1D problems). When the fast assembly option is enabled, it is not possible to postprocess the solid particle concentration along the particle dimension, and the diffusion coefficient in the particle cannot vary along the particle depth. The same equations are solved for regardless of assembly method.

The fast assembly option is not available if **Baker-Verbrugge** species concentration transport model is enabled.

HEAT OF MIXING

This section is not available if **No spatial gradients** is selected under **Particle Transport Settings**, or if **Use fast assembly in particle dimension** is enabled under **Particle Discretization**.

Include heat of mixing defines a heat source defined as the gradient of the molar enthalpy times the molar flux of the intercalating species, integrates it over the particle, and adds it to the total heat source variable in the domain. The molar enthalpy is based on the **Equilibrium potential** of the insertion reaction, defined below.

The heat source is typically used when coupling the battery interface to a heat transfer interface using the [Electrochemical Heating](#) node.

The heat of mixing is usually small in relation the other heat sources in the battery, such as Joule heating in the electrolyte, or the heat of reactions.

EQUILIBRIUM POTENTIAL

This section defines the Equilibrium potential of the intercalation reaction, E_{eq} (SI unit: V), used by the **Particle Transport Properties** and **Heat of Mixing** sections, when applicable.

STRESS AND STRAIN

This section is not available if **No spatial gradients** or the particle type **Flakes** is selected under **Particle Transport Settings**, or if **Use fast assembly in particle dimension** is enabled under **Particle Discretization**.

When modeling diffusion in the particle you may enable the **Calculate stress and strain** check box to compute a number stress and strain related variables in the particle. The variables are based on the Young's modulus and Poisson's ratio values and the relative volume change of the particle. The relative volume change is typically dependent on the concentration in the particle.

See also [Stress and Strain in Intercalating Particles](#) in the theory chapter below.



Diffusion-Induced Stress in a Lithium-Ion Battery: Application Library
path **Battery_Design_Module/Batteries,_Lithium-Ion/**
lib_diffusion_induced_stress

Porous Electrode Reaction

The **Porous Electrode Reaction** node defines the electrode kinetics for a charge transfer reaction that occurs at the interface between the pore electrolyte and the electrode matrix a porous electrode. The node can be added as subnode to a **Porous Electrode** node. Add multiple nodes to the same **Porous Electrode** node to model multiple reactions, for instance in self-discharge or capacity fade problems.

See the [Electrode Reaction](#) node in [Shared Physics Features in the Current Distribution Interfaces](#) for a general description of the Equilibrium Potential, Electrode Kinetics and Stoichiometric Coefficients sections.

ELECTRODE KINETICS

The battery interfaces have some tailor-made kinetic expressions types (see also [Electrode Reaction](#)).

Lithium Insertion

The charge transfer reaction can be described by the reaction at the surface of the electrode particles with subsequent lithium intercalation. This solves the charge transfer current density in the particles in combination with the diffusion of the intercalating species (see the theory section).

The **Lithium insertion** option is available for the Lithium-Ion Battery interface. The expression is suitable for any positive or negative intercalation reaction. The **Reference exchange current density** $i_{0,\text{ref}}(T)$ (SI unit: A/m^2) or the **Rate constant** k (SI unit: m/s) depends on the electrode material in use and the temperature.

Insertion Reaction

The **Insertion reaction** option is available for the Battery with Binary Electrolyte interface. It can be used for both the positive and the negative electrode main reactions of a NiMH battery. The **Reference exchange current density** $i_{0,\text{ref}}(T)$ (SI unit: A/m^2) depends on the electrode material in use and the temperature.

Lead–Acid Battery Charge and Lead–Acid Battery Discharge

These options are available for the Lead–Acid Battery interface. The kinetic section is equal between the **Lead–acid battery charge** or **Lead–acid battery discharge**, but the **Active specific surface area** equations differ.

ADVANCED INSERTION KINETICS SETTINGS

To display this section, click the **Show More Options** button () and select **Advanced Physics Options**.

By enabling **Extrapolate insertion kinetics using first order kinetics for high and low socs** numerical stability can be improved for solid concentration values close to 0 or the maximum concentration. The feature is enabled by default. Use the **Extrapolation soc window width** to specify how close to 0 or the maximum soc the extrapolated kinetics expression should be used.

The option is available both for the Lithium Insertion and the Insertion Reaction kinetics.

ACTIVE SPECIFIC SURFACE AREA

The **Active specific surface area** a_v (SI unit: m^2/m^3) specifies the area of the electrode-electrolyte interface that is catalytically active for this porous electrode reaction. a_v is multiplied by i_{1oc} (defined in the **Electrode Kinetics** section) to produce a current source in the domain.

When using a **Particle-based area** the particle radius is taken from the parent node if using **Intercalating particles** (Lithium-ion and Battery with Binary Electrolyte interfaces).

For the Lead–Acid Battery interface the active surface area can also be calculated as a function of the porosity of the electrodes, which changes during discharge and recharge as defined by the **Maximum active surface area**, a_{max} (dimensions L^2/L^3 ; that is, the SI unit is $1/\text{m}$) and the **Morphology number** (dimensionless).

Reaction Source

Use the **Reaction Source** node to define sources or sinks in the mass balance of the salt in the electrolyte. To display this option, click the **Show More Options** button () and select **Advanced Physics Options** then select **Reaction Source** from the **Additional Sources** submenu.

Additional Porous Electrode Material

Use the **Additional Porous Electrode Material** node to define an additional porous electrode material in a porous electrode, for instance to solve for an additional intercalation concentration in the solid phase of the electrode particles. The feature can only be applied to domains that contain an active [Porous Electrode](#) node. A [Porous Electrode Reaction](#) node is added by default.

You specify the reactions occurring on the additional material, giving rise to fluxes in and out from the electrode particles, using [Porous Electrode Reaction](#) subnodes, which is available from the context menu (right-click the parent node) or from the **Physics** toolbar, **Attributes** menu. Also add a [Porous Matrix Double-Layer Capacitance](#) and, for the Battery with Binary Electrolyte interface, a [Porous Matrix Adsorption/Desorption Reaction](#) subnode.

The current sources and sinks defined in the Additional Porous Electrode Material subnodes are also used in the Porous Electrode node domain equations that describe the electrolyte and electrode current balances, and the mass balance for the electrolyte salt.

This physics node is available for the Lithium-Ion Battery and Battery with Binary Electrolyte interfaces.

See the [Porous Electrode](#) for more information about the settings of this node.

Porous Conductive Binder

Use the **Porous Conductive Binder** node to define an electrochemically inactive but electronically conductive porous domains.

Use correction factors to account for the lowered diffusion coefficient and conductivity in the electrolyte and the lowered conductivities of the electrode, as a result of the lower volume fractions of each phase, and the tortuosity of the porous matrix.

You can specify the **Nonfaradaic Reactions** occurring on the domain as a subnode, which is available from the context menu (right-click the parent node) or from the **Physics** toolbar, **Attributes** menu. You can also add a [Porous Matrix Double-Layer Capacitance](#) subnode and, [Dissolving-Depositing Species](#) section in the porous conductive binder.

See also the [Electrolyte](#) and [Current Conductor](#) nodes for more information about the settings of this node.

ELECTROLYTE PROPERTIES

See the [Electrolyte](#) node for more information about the settings of this section.

ELECTRODE PROPERTIES

See the [Current Conductor](#) node for more information about the settings of this section

POROUS MATRIX PROPERTIES

The **Electrode volume fraction** ε_s and **Electrolyte volume fraction** ε_1 parameters are used in the mass balance equations to account for the available volume of each phase. The default value for each fraction is 0.4. These parameter values may also be used by the **Effective Transport Parameter Correction** (next section). Similarly, the **Electrode tortuosity** τ_s and **Electrolyte tortuosity** τ_1 parameters may also be used by the **Effective Transport Parameter Correction** (next section). Select either **Isotropic** to define a scalar value, or **Diagonal** and **Symmetric** to define anisotropic tensor values. The default is **Isotropic 1**.

EFFECTIVE TRANSPORT PARAMETER CORRECTION

Use the settings of this section to calculate effective transport parameters for the electrode and the electrolyte if your corresponding parameter values refer to nonporous media.

DISSOLVING-DEPOSITING SPECIES

Use the settings of this section to define species that participate in dissolution-deposition electrode reactions within the porous matrix of the binder, for instance, metal deposition/dissolution or oxide formation.

Use the **Add** (+) and **Delete** () buttons as needed in the tables to control the number of species.

Dependent variables for the volumetric molar concentration are added for each dissolving-depositing species.

The **Density** and **Molar mass** determine the electrode growth velocity and the resulting dissolved/deposited layer thickness. By multiplying by the electrode surface area (in the case of multiple electrode reaction the average surface area is used), the change in electrode and electrolyte volume fractions can be also be calculated. By use of the **Add volume change to electrode volume fraction** and **Subtract volume change from electrolyte volume fraction** check boxes you may define how these volume changes should be included in the model.

Thickness variables, based on the surface area, are also defined that you for instance can use to couple to the Film Resistance (see below).

FILM RESISTANCE

A film resistance is typically used for modeling the build-up of a SEI (solid electrolyte interface) layer in lithium-ion battery graphite electrodes. This might be important for accounting the changes in electrical conductivity of the electronic phase.

This physics node is available for the Lithium-Ion Battery and Battery with Binary Electrolyte interfaces.

Concentration

Add the **Concentration** boundary condition from the **Electrolyte** submenu to set the **Concentration on boundary** of the salt to a given value or expression.

No Flux

A **No Flux** boundary condition is added by default for all external boundaries to an electrolyte domain.

Select additional nodes from the **Electrolyte** submenu overwrite this boundary condition.

Flux

Add the **Flux** boundary condition from the **Electrolyte** submenu to set the **Salt electrolyte inward flux**.

The flux of ions will be set in the normal direction to the boundary.

SOC and Initial Charge Distribution

This global node is activated by enabling **Define cell state of charge and initial charge inventory** on the interface top node. The node is only available in the Lithium-Ion Battery and Battery with Binary Electrolyte interfaces.

The node can be used to define and compute various dynamic global cell variables such as the cell capacity, state of charge (SOC) and state of health (SOH), and it also allows for specifying the initial SOC of the battery in terms of either cell voltage, cell SOC, or the individual positive and negative electrode potentials, or charge inventories.

The following variables are defined and made available for global evaluation by the node (where xxx refers to the interface name, for instance liion, or batbe):

TABLE 3-1: VARIABLES FOR SOC AND INITIAL CHARGE DISTRIBUTION.

VARIABLE NAME	UNIT	DESCRIPTION
xxx.SOC_cell	dimensionless	Cell state of charge
xxx.SOH_cell	dimensionless	Cell state of health
xxx.I_1C	A	1C cell current
xxx.Cap_cell	C (Ah)	Cell capacity

The node has two child nodes: [Negative Electrode Selection](#) and the [Positive Electrode Selection](#), and it is required that the **Domain Selection** of these child nodes coincide with the selection of one or several active [Particle Intercalation](#) nodes (child nodes to [Porous Electrode](#) or [Additional Porous Electrode Material](#)) in the model.

The **Cell Type** can be set to either **Full cell** or **Half cell**. For **Full cell**, both the negative and positive child nodes are active. For **Half cell**, only the positive child node is active, and the (fixed) negative electrode potential is instead defined by the **Reference (counter) electrode equilibrium potential** setting.

In the **State-of-Charge Definition** section, the cell voltages at 0% and 100% SOC are defined. These voltages are used to connect the SOC of the battery cell to the individual charge levels of the [Particle Intercalation](#) nodes.

The cell voltages at 0% and 100% SOC may be either defined **From operational potential limits**, or **User defined**. For the **From operational potential limits** case, the settings of the **Operational Potential Limits** section in the [Particle Intercalation](#) nodes, in combination with the [Negative Electrode Selection](#) and [Positive Electrode Selection](#), are used to define the 0% and 100% SOC cell voltages.

The **Initial Cell Charge Distribution** section defines the initial concentration levels of all [Particle Intercalation](#) nodes included in the [Negative Electrode Selection](#) and [Positive Electrode Selection](#). The initial charge distribution may be defined by either **Cell state of charge**, a **Cell Voltage**, **Electrode Potential** or **Electrode Charge Inventory**.

For a **Full cell**, when specifying a **Cell state of charge** or a **Cell Voltage** also the total charge inventory of the cell needs to be set. This may be done either based on the **Positive electrode host capacity**, the **Negative electrode host capacity** or an **Explicit value**. It is also possible to enable **Add formation loss** to reduce the initial charge inventory, assuming that some charge inventory has been irreversibly lost prior to the start of the

simulation. The formation loss can be set either to **Fraction of negative host capacity**, **Fraction of positive host capacity**, or an explicit **Charge** value..



By default the initial charge inventory is based on the **Positive electrode host capacity**, with an added formation loss set to **Fraction of negative host capacity**. This corresponds to, for instance, the common case of a lithium-ion battery, where all cyclable lithium after manufacturing stems from the positive electrode material (such as LCO, NCA, NMC etc). A small fraction of inventory is irreversibly lost during initial cycling due to the formation of the solid-electrolyte interphase (SEI) at the surface of negative graphite electrode particles.



- [Cell Capacity and State of Charge](#)
- [Defining Initial Cell Charge Distributions Based on Cell Voltage or Cell State of Charge](#)

Negative Electrode Selection

The **Negative Electrode Selection** node is available as a child node to the [SOC and Initial Charge Distribution](#) to define the polarity of a battery cell model.

The **Domain selection** of the node may not be empty and should be set all active [Particle Intercalation](#) nodes (child nodes to [Porous Electrode](#) or [Additional Porous Electrode Material](#)) belonging to the negative electrode side of a battery cell model.

The node is only available in the Lithium-Ion Battery and Battery with Binary Electrolyte interfaces.

Positive Electrode Selection

The **Positive Electrode Selection** node is available as a child node to the [SOC and Initial Charge Distribution](#) to define the polarity of a battery cell model.

The **Domain selection** of the node may not be empty and should be set all active [Particle Intercalation](#) nodes (child nodes to [Porous Electrode](#) or [Additional Porous Electrode Material](#)) belonging to the positive electrode side of a battery cell model.

The node is only available in the Lithium-Ion Battery and Battery with Binary Electrolyte interfaces.

Theory for the Lithium-Ion Battery Interface

The **Lithium-Ion Battery Interface** defines the current balance in the electrolyte, the current balances in the electrodes, the mass balance for the lithium salt, and the mass balance of lithium in lithium-ion batteries.

The electrolyte in the modeled batteries has to be a quiescent binary 1:1 electrolyte, containing lithium cations (Li^+) and anions (An^-).

The physics interface solves for five dependent variables:

- ϕ_s , the electric potential,
- ϕ_l , the electrolyte potential,
- $\Delta\phi_{s,\text{film}}$, the potential losses due to a resistive film on the electrode particles in the porous electrodes, also called solid-electrolyte interface (SEI),
- c_s , the concentration of lithium ($\text{Li}\Theta_s$) in the electrode particles, and
- c_l , the electrolyte salt concentration.

In the electrolyte and pore electrolyte, two variables are defined, ϕ_l and c_l . Assuming electroneutrality, c_l denotes both the Li^+ concentration and the An^- concentration.

The domain equations in the electrolyte are the conservation of current and the mass balance for the salt according to the following:

$$\nabla \cdot \left(-\sigma_l \nabla \phi_l + \frac{2\sigma_l RT}{F} \left(1 + \frac{\partial \ln f}{\partial \ln c_l} \right) (1 - t_+) \nabla \ln c_l \right) = i_{\text{tot}} + Q_l$$

$$\varepsilon_l \frac{\partial c_l}{\partial t} + \nabla \cdot (-\varepsilon_l D_l \nabla c_l) = R_l - \left(\frac{i_{\text{tot}} + Q_l}{F} \right) t_+$$

where σ_l denotes the electrolyte conductivity, f the activity coefficient for the salt, t_+ the transport number for Li^+ (also called transference number), i_{tot} the sum of all electrochemical current sources, and Q_l denotes an arbitrary electrolyte current source. In the mass balance for the salt, ε_l denotes the electrolyte volume fraction, D_l the electrolyte salt diffusivity, and R_l the total Li^+ source term in the electrolyte.

In the electrode, the current density, \mathbf{i}_s , is defined as

$$\mathbf{i}_s = -\sigma_s \nabla \phi_s$$

where σ_s is the electrical conductivity.

The domain equation for the electrode is the conservation of current expressed as

$$\nabla \cdot \mathbf{i}_s = -i_{\text{tot}} + Q_s$$

where Q_s is an arbitrary current source term.

The electrochemical reactions in the physics interface are assumed to be insertion reactions occurring at the surface of small solid spherical particles of radius r_p in the electrodes. The insertion reaction is described as

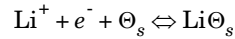

where Θ_s denotes a free reaction site and $\text{Li}\Theta_s$ an occupied reaction site at the solid particle surface.

The concentration of Θ_s does not have to be solved for since the total concentration of reaction sites, $c_{s,\text{max}}$, is assumed to be constant, implying that

$$c_{\Theta_s} = c_{s,\text{max}} - c_s$$

An important parameter for lithium insertion electrodes is the state-of-charge variable for the solid particles, denoted soc . This is defined as

$$\text{soc} = \frac{c_s}{c_{s,\text{max}}}$$

The equilibrium potentials E_0 of lithium insertion electrode reactions are typically functions of soc .

The electrode reaction occurs on the particle surface and lithium diffuses to and from the surface in the particles. The mass balance of Li in the particles is described using

$$\frac{\partial c_s}{\partial t} + \nabla \cdot N_s = 0$$

where, for Fick's law, the molar flux N_s is defined as

$$N_s = -D_s \nabla c_s$$

where c_s is the concentration of Li in the solid phase. This equation is solved locally by this physics interface in a 1D pseudo dimension, with the solid phase concentrations at the nodal points for the element discretization of the particle as the independent variables. The gradient is calculated in Cartesian, cylindrical, or spherical coordinates, depending on if the particles are assumed to be best described as flakes, rods, or spheres, respectively.

For the case of Baker–Verbrugge diffusion (Ref. 3), the flux vector is defined as

$$N_s = -\left(1 + \frac{\partial \ln \gamma_s}{\partial \ln x_s}\right) D_s \nabla c_s$$

where

$$1 + \frac{\partial \ln \gamma_s}{\partial \ln x_s} = -\frac{F}{RT} \left(\frac{c_{s, \max} - c_s}{c_{s, \max}} \right) c_s \frac{\partial E_{\text{eq}}}{\partial c_s}$$

The boundary conditions are defined as follows:

$$\begin{aligned} N_s &= 0 \Big|_{r=0} \\ N_s &= -R_{\text{Li}\ominus} \Big|_{r=r_p} \end{aligned}$$

where $R_{\text{Li}\ominus}$ denotes the molar flux of lithium at the particle surface, caused by the electrochemical insertion reactions.

The stoichiometric notations used in the physics interface are according to the general electrochemical reaction as expressed below:

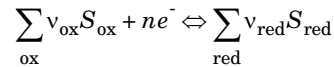

where the stoichiometric coefficients, ν_i , is positive (ν_{ox}) for products and negative (ν_{red}) for reactants in a reduction reaction. From this definition, the number of electrons, n , in the electrode reaction can be calculated according to

$$n = -\sum_i z_i \nu_i$$

where z_i denotes the charge of species i . According to these relations, the lithium insertion reaction has the following stoichiometric coefficients:

$$\begin{aligned}v_{\text{Li}^+} &= -1 \\v_{\text{An}^-} &= 0 \\v_{\text{Li}\Theta_s} &= 1\end{aligned}$$

with a resulting $n = 1$. These are the default settings for the reactions in this physics interface. When modeling other reactions, such as irreversible anion oxidation or noninsertion solid lithium metal deposition, other coefficients have to be used.

In the porous electrodes, i_{tot} , denotes the sum of all charge transfer current density contributions according to:

$$i_{\text{tot}} = \sum A_{v,m} i_{\text{loc},m}$$

where, A_v denotes the specific surface. The source term in the mass balance is calculated from:

$$R_{l,p} = -\sum_m A_{v,m} \frac{v_{\text{Li}^+,m} i_{\text{loc},m}}{n_m F}$$

It is also possible to specify additional reaction sources, $R_{l,\text{src}}$, that contribute to the total species source according to:

$$R_l = R_{l,p} + R_{l,\text{src}}$$

At the surface of the solid particles the following equation applies:

$$R_{\text{Li}\Theta} = -\sum_m \frac{v_{\text{Li}\Theta,m} i_{\text{loc},m}}{n_m F} \frac{A_{v,m}}{(N_{\text{shape}} \epsilon_s) / r_p}$$

where the last factor (normally equal to 1) is a scaling factor accounting for differences between the surface area ($A_{v,m}$) used to calculate the volumetric current density, and the surface area of the particles in the solid lithium diffusion model. N_{shape} is 1 for Cartesian, 2 for cylindrical, and 3 for spherical coordinates.

If the solid phase diffusion coefficient is very large or if the spatial concentration gradients in the particle can be neglected, the solid phase concentration evolution in time can be calculated from

$$\frac{\partial \epsilon_s c_s}{\partial t} = R_{v\Theta}$$

The molar source $R_{v\Theta}$ at the positive and negative electrodes is given as follows:

$$R_{v\Theta} = -\sum_m \frac{v_{\text{Li}\Theta, m} A_{v, m} i_{\text{loc}, m}}{n_m F}$$

A resistive film (also called solid-electrolyte interface, SEI) might form on the solid particles resulting in additional potential losses in the electrodes. To model a film resistance, an extra solution variable for the potential variation over the film, $\Delta\phi_{s, \text{film}}$, is introduced in the physics interface. The governing equation is then according to

$$\Delta\phi_{s, \text{film}} = i_{\text{tot}} R_{\text{film}}$$

where R_{film} (SI unit: $\Omega\cdot\text{m}^2$) denotes a generalized film resistance. The activation overpotentials, η_m , for all electrode reactions in the electrode then receives an extra potential contribution, which yields

$$\eta_m = \phi_s - \Delta\phi_{s, \text{film}} - \phi_l - E_{\text{eq}, m}$$

CELL CAPACITY AND STATE OF CHARGE

For a fully relaxed battery cell (at open circuit), the cell voltage E_{cell} (V) equals the difference between the relaxed positive and negative electrode potentials.

$$E_{\text{cell}} = E_{\text{pos}} - E_{\text{neg}}$$

Thermodynamically (consider for instance the Nernst equation), infinitely high or low electrode potentials are required to either fully discharge (delithiate) or charge (lithiate) an intercalating battery electrode, which on cell level would correspond to either infinitely high or low cell voltages for a completely charged or discharged battery. During normal operation, the cell voltage is limited, and the full host capacity ($c_{s, \text{max}}$) of neither electrode is hence fully utilized. In addition, the integrated host capacities of the positive and negative electrodes typically differ in order to provide a safety margin in order to avoid parasitic reactions, for instance, lithium plating.

The state of charge (SOC) of a battery cell can be coupled to the concentration levels (c_s) of the individual electrode materials starting with the definition of two voltage parameters: The cell voltage at 100% SOC, $E_{\text{cell}}^{100\% \text{ SOC}}$ (V), and the cell voltage at 0% SOC, $E_{\text{cell}}^{0\% \text{ SOC}}$ (V), which relate to the corresponding electrode potentials as

$$E_{\text{cell}}^{100\% \text{ SOC}} = E_{\text{pos}}^{100\% \text{ SOC}} - E_{\text{neg}}^{100\% \text{ SOC}}$$

and

$$E_{\text{cell}}^{0\% \text{ SOC}} = E_{\text{pos}}^{0\% \text{ SOC}} - E_{\text{neg}}^{0\% \text{ SOC}}$$

The cell voltage relations provide one equation for the two unknown positive and negative electrode potentials at each SOC level.

The second needed equation for defining E_{pos} and E_{neg} (for any SOC level) can be derived by assuming conservation of the lithium inventory.

The concentration of intercalated lithium of an electrode at equilibrium, $c_{s,\text{eq}}$ (mol/m³) is a function of the electrode potential

$$c_{s,\text{eq}} = c_{s,\text{eq}}(E)$$

Integrating the equilibrium concentration over the whole domain, Ω , where an electrode material is present, allows for computing the lithium inventory, Q_{inv}^e (C), for the corresponding potential at equilibrium

$$Q_{\text{inv}}^e(E) = c_{s,\text{eq}}(E)F \int \varepsilon_s d\Omega$$

Similarly, at any point in a simulation we may also compute the present charge inventories in the battery model by integrating the intercalated concentrations in the corresponding domains

$$Q_{\text{inv,neg}} = \int_{\text{neg}} \varepsilon_s c_s F d\Omega$$

and

$$Q_{\text{inv,pos}} = \int_{\text{pos}} \varepsilon_s c_s F d\Omega$$

Finally, the second needed equation is found by setting the sum of the positive and negative lithium inventories at equilibrium equal to the total amount of lithium in the cell, $Q_{\text{inv,cell}}$

$$Q_{\text{inv,pos}}^e(E_{\text{pos}}) + Q_{\text{inv,neg}}^e(E_{\text{neg}}) = Q_{\text{inv,neg}} + Q_{\text{inv,pos}} = Q_{\text{inv,cell}}$$

Once the electrode potentials at 0% and 100% SOC are known, the battery capacity, $\text{Cap}_{\text{cell}}(C)$, can be defined as

$$\text{Cap}_{\text{cell}} = Q_{\text{inv,neg}}^{100\% \text{ SOC}} - Q_{\text{inv,neg}}^{0\% \text{ SOC}} = Q_{\text{inv,pos}}^{0\% \text{ SOC}} - Q_{\text{inv,pos}}^{100\% \text{ SOC}}$$

Here the superscripts and subscripts indicate which cell state of charge, electrode, and potential $Q_{inv}^e(E)$ that are evaluated.

Subsequently, the cell state of charge, SOC (1), may be defined as

$$SOC = \frac{Q_{inv, neg} - Q_{inv, neg}^{0\% SOC}}{Cap_{cell}} = \frac{Q_{inv, pos}^{0\% SOC} - Q_{inv, pos}}{Cap_{cell}}$$

As a battery ages, E_{pos} and E_{neg} at 0% and 100% SOC may change as a result of changes in the total inventory and/or the electrode volume fractions. This will give rise to a changing capacity. The fraction of the present capacity to the initial capacity defines the state of health, SOH (1), as

$$SOH = \frac{Cap_{cell}}{Cap_{cell, init}}$$

Common in battery engineering is to define the battery current in terms of C rates, where a 1C rate corresponds to the (ideal) time required to discharge the battery in 1 hour. The 1C current, I_{1C} (A), may hence be calculated as

$$I_{1C} = \frac{Cap_{cell}}{1 \text{ h}}$$

Note by this definition of the 1C current, polarization losses (originating from, for example, mass transport and electrochemical reaction limitations) are not accounted for. Usually a battery cell will not be able to support the 1C current for the whole course of an hour.

DEFINING INITIAL CELL CHARGE DISTRIBUTIONS BASED ON CELL VOLTAGE OR CELL STATE OF CHARGE

The framework in the above section can also be used to define the initial concentration levels in intercalating electrodes based on an initial cell voltage or cell SOC. For both cases, an initial cell inventory $Q_{inv, cell, 0}$ (C) parameter is required as user input.

When defining an initial cell voltage, $E_{cell, init}$, the corresponding initial electrode potentials, $E_{pos, init}$ and $E_{neg, init}$, are determined from the relations

$$E_{cell, init} = E_{pos, init} - E_{neg, init}$$

and

$$Q_{inv, pos}^e(E_{pos, init}) + Q_{inv, neg}^e(E_{neg, init}) = Q_{inv, cell, 0}$$

When defining the cell state of charge, SOC_0 (1), the second relation above is used similarly in combination with $E_{\text{cell}}^{100\% \text{ SOC}}$ and $E_{\text{cell}}^{0\% \text{ SOC}}$ in order to define the initial potentials at 0% and 100% SOC, and the initial potentials are in turn calculated using the relations

$$\text{SOC}_0 = \frac{Q_{\text{inv, neg}}^e(E_{\text{neg, init}}) - Q_{\text{inv, neg}}^e(E_{\text{neg, init}}^{0\% \text{ SOC}})}{Q_{\text{inv, neg}}^e(E_{\text{neg, init}}^{100\% \text{ SOC}}) - Q_{\text{inv, neg}}^e(E_{\text{neg, init}}^{0\% \text{ SOC}})}$$

and

$$\text{SOC}_0 = \frac{Q_{\text{inv, pos}}^e(E_{\text{pos, init}}) - Q_{\text{inv, neg}}^e(E_{\text{pos, init}}^{0\% \text{ SOC}})}{Q_{\text{inv, pos}}^e(E_{\text{pos, init}}^{100\% \text{ SOC}}) - Q_{\text{inv, neg}}^e(E_{\text{pos, init}}^{0\% \text{ SOC}})}$$

STRESS AND STRAIN IN INTERCALATING PARTICLES

The electrode host material can undergo significant volume changes during charging and discharging. If concentration gradients are present in the electrode particles, resulting in inhomogeneous elastic deformation, this will give rise to stresses.

Since atomic diffusion in solids is a much slower process than elastic deformation, mechanical equilibrium is established much faster than that of diffusion. Hence, mechanical equilibrium can be treated as a static equilibrium problem. In the analysis below, the electrode particles (spheres or cylinders) are assumed to be isotropic linear elastic solids.

The relative change in volume $\delta V/V_0$ is typically dependent on the solid phase concentration c_s (or the state-of-charge variable soc). Note that c_s is solved for in a 1D extra dimension using spherical or cylindrical coordinate systems (for spheres or cylinders, respectively), as described above. In the equations presented below, the relative volume change is considered to be a generic function of the concentration $\Delta V/V_0 = f_{\text{vol}}(c_s(r))$.

Particle Type: Spheres

The relationships between stress, $\sigma(r)$ (SI unit: Pa), and strain, $\varepsilon(r)$ (SI unit: 1), expressed in the spherical coordinate system for the radial and tangential components (considering that $\sigma_\theta(r) = \sigma_\phi(r)$) are

$$\varepsilon_r(r) = \frac{1}{E}[\sigma_r(r) - 2\nu\sigma_\theta(r)] + \frac{1}{3}f_{\text{vol}}(c_s(r))$$

$$\varepsilon_{\theta}(r) = \frac{1}{E}[\sigma_{\theta}(r) - \nu(\sigma_{\theta}(r) + \sigma_r(r))] + \frac{1}{3}f_{\text{vol}}(c_s(r))$$

where E (SI unit: Pa) is Young's modulus and ν (SI unit:1) is Poisson's ratio. It is assumed that these elastic properties are independent of concentration.

The expressions for radial and tangential stresses in a spherical particle of radius r_p that satisfy the boundary condition $\sigma_r(r_p) = 0$ and remain finite at $r = 0$, can be obtained as follows, by solving the equation for static mechanical equilibrium in the absence of any body force:

$$\sigma_r(r) = \frac{2E}{3(1-\nu)} \left(\frac{1}{3} \int_{r_p}^{r_p} f_{\text{vol}}(c_s(r')) r'^2 dr' - \frac{1}{3} \int_0^r f_{\text{vol}}(c_s(r')) r'^2 dr' \right)$$

$$\sigma_{\theta}(r) = \frac{E}{3(1-\nu)} \left(\frac{2}{3} \int_{r_p}^{r_p} f_{\text{vol}}(c_s(r')) r'^2 dr' + \frac{1}{3} \int_0^r f_{\text{vol}}(c_s(r')) r'^2 dr' - f_{\text{vol}}(c_s(r)) \right)$$

where the two integrals represent contributions, respectively, one given by an integral over the entire volume of the spherical particle and another given by an integral over a spherical volume of radius r within the particle. Note, that the tangential component additionally contains a local term as given by the last term in the expression.

The hydrostatic stress $\sigma_h(r)$ (SI unit: Pa) (or the mean stress) is given by

$$\sigma_h(r) = \frac{\sigma_r(r) + 2\sigma_{\theta}(r)}{3}$$

The von Mises stress $\sigma_v(r)$ (SI unit: Pa) given by

$$\sigma_v(r) = |\sigma_r(r) - \sigma_{\theta}(r)|$$

Because of spherical symmetry, one principal shear stress is zero and the other two are both equal to $(\sigma_r(r) - \sigma_{\theta}(r))/2$.

The strain energy density $W_s(r)$ (SI unit: J/m³) accumulated as a result of the elastic deformation for the isotropically deformed sphere is given as

$$W_s(r) = \frac{\sigma_r^2(r) + 2\sigma_{\theta}^2(r) - 2\nu\sigma_{\theta}(r)(2\sigma_r(r) + \sigma_{\theta}(r))}{2E}$$

The total elastic strain energy density stored in the host electrode material $W_{s,\text{tot}}(r)$ (SI unit: J/m^3), which provides the driving force for fracture, is obtained as,

$$W_{s,\text{tot}}(r) = \frac{3\varepsilon_s}{r_p} \int_0^{r_p} W_s(r') r'^2 dr'$$

where ε_s is the electrode volume fraction in the host material.

Particle Type: Cylinders

The relationships between stress, $\sigma(r)$, and strain, $\varepsilon(r)$, expressed in the cylindrical coordinate system for the radial, tangential, and axial components are as follows:

$$\varepsilon_r(r) = \frac{1}{E} [\sigma_r(r) - \nu(\sigma_\theta(r) + \sigma_z(r))] + \frac{1}{3} f_{\text{vol}}(c_s(r))$$

$$\varepsilon_\theta(r) = \frac{1}{E} [\sigma_\theta(r) - \nu(\sigma_z(r) + \sigma_r(r))] + \frac{1}{3} f_{\text{vol}}(c_s(r))$$

$$\varepsilon_z(r) = \frac{1}{E} [\sigma_z(r) - \nu(\sigma_r(r) + \sigma_\theta(r))] + \frac{1}{3} f_{\text{vol}}(c_s(r))$$

The expressions for radial, tangential, and axial diffusion-induced stresses for a transversely isotropic cylindrical particle of radius r_p are

$$\sigma_r(r) = \frac{E}{3(1-\nu)} \left(\frac{1}{r_p^2} \int_0^{r_p} f_{\text{vol}}(c_s(r')) r' dr' - \frac{1}{r^2} \int_0^r f_{\text{vol}}(c_s(r')) r' dr' \right)$$

$$\sigma_\theta(r) = \frac{E}{3(1-\nu)} \left(\frac{1}{r_p^2} \int_0^{r_p} f_{\text{vol}}(c_s(r')) r' dr' + \frac{1}{r^2} \int_0^r f_{\text{vol}}(c_s(r')) r' dr' - f_{\text{vol}}(c_s(r)) \right)$$

$$\sigma_z(r) = \frac{E}{3(1-\nu)} \left(\frac{2}{r_p^2} \int_0^{r_p} f_{\text{vol}}(c_s(r')) r' dr' - f_{\text{vol}}(c_s(r)) \right)$$

The hydrostatic stress $\sigma_h(r)$ is given by

$$\sigma_h(r) = \frac{\sigma_r(r) + \sigma_\theta(r) + \sigma_z(r)}{3}$$

The von Mises stress $\sigma_v(r)$ is given by

$$\sigma_v(r) = \sqrt{\frac{(\sigma_r(r) - \sigma_\theta(r))^2 + (\sigma_\theta(r) - \sigma_z(r))^2 + (\sigma_z(r) - \sigma_r(r))^2}{2}}$$

The strain energy density $W_s(r)$ accumulated as a result of the elastic deformation for the isotropically deformed cylinder is given as

$$W_s(r) = \frac{\sigma_r^2(r) + \sigma_\theta^2(r) + \sigma_z^2(r) - 2\nu(\sigma_r(r)\sigma_\theta(r) + \sigma_\theta(r)\sigma_z(r) + \sigma_z(r)\sigma_r(r))}{2E}$$

The total elastic strain energy density stored in the host electrode material $W_{s,tot}(r)$ is given as

$$W_{s,tot}(r) = \frac{2\varepsilon_s}{r_p^2} \int_0^{r_p} W_s(r') r' dr'$$

References

1. K.E. Thomas, J. Newman, and M. Darling, *Mathematical Modeling of Lithium Batteries*, Chapter 12 in *Advances in Lithium-Ion Batteries*, edited by W.A. van Schalkwijk and B Scrosati, 2002, Kluwer Academic/Plenum Publishers.
2. M. Doyle and others, *J. Electrochem. Soc.*, vol. 143, p. 1890, 1996.
3. D.R. Baker and M.W. Verbrugge, "Intercalate diffusion in multiphase electrode materials and application to lithiated graphite," *J. Electrochem. Soc.*, vol. 159, no. 8, pp. A1341–A1350, 2012.

Theory for the Battery with Binary Electrolyte Interface

The [Battery with Binary Electrolyte Interface](#) defines the current balance in the electrolyte, the current balances in the electrodes, the mass balance for a salt, and the mass balance of an intercalating species such as hydrogen in a nickel–metal hydride battery.

The electrolyte in the modeled batteries has to be a quiescent alkaline binary 1:1 electrolyte, containing a cation (Cat^+) and an anion (An^-).

The physics interface solves for five dependent variables:

- ϕ_s , the electric potential,
- ϕ_l , the electrolyte potential
- $\Delta\phi_{s, \text{film}}$, the potential drop due to a resistive film on the electrode particles in the porous electrodes
- c_s , the concentration of an *intercalating species* in the electrode particles
- c_l , the electrolyte salt concentration

In the electrolyte and pore electrolyte, two variables are defined: ϕ_l and c_l . Assuming electroneutrality, c_l denotes both the Cat^+ concentration and the An^- concentration.

The domain equations in the electrolyte are the conservation of current and the mass balance for the salt according to the following:

$$\begin{aligned}\nabla \cdot \mathbf{i}_l &= i_{\text{tot}} + \mathbf{Q}_l \\ \mathbf{i}_l &= -\sigma_l \nabla \phi_l - \frac{2\sigma_l RT}{F} \left(1 + \frac{\partial \ln f}{\partial \ln c_l} \right) \left(t_+ + \frac{c_l}{c_0} \right) \nabla \ln c_l \\ \frac{\partial \varepsilon_l c_l}{\partial t} + \nabla \cdot \mathbf{N}_l &= R_l \\ \mathbf{N}_l &= -D_l \nabla c_l + \frac{\mathbf{i}_l t_+}{F}\end{aligned}$$

where \mathbf{i}_l denotes the electrolyte current density, σ_l the electrolyte conductivity, f the activity coefficient for the salt, t_+ the *transport number* for Cat^+ (also called transference number), i_{tot} the sum of all electrochemical current sources, c_0 the solvent

concentration, and Q_l denotes an arbitrary electrolyte current source. In the mass balance for the salt, \mathbf{N}_l denotes the flux of the cation, ε_l the electrolyte volume fraction, D_l the electrolyte salt diffusivity, and R_l the total Cat^+ source term in the electrolyte.

In the electrode, the current density, \mathbf{i}_s , is defined as

$$\mathbf{i}_s = -\sigma_s \nabla \phi_s$$

where σ_s is the electrical conductivity.

The domain equation for the electrode is the conservation of current expressed as

$$\nabla \cdot \mathbf{i}_s = -i_{\text{tot}} + Q_s$$

where Q_s is an arbitrary current source term.

Reactions occur on the surface of small solid spherical host particles of radius r_p . The reactions can either be electrochemical or chemical adsorption/desorption reactions not involving electrons.

The electrochemical reactions involve cations or anions and are written generally as

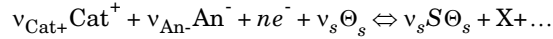

where Θ_s is a free reaction site and $S\Theta_s$ is an occupied reaction site at the solid particle surface. Additional product species (X , ...) are not handled by this physics interface.

The absorption/desorption chemical reactions that do not involve charged species and are written generally as:

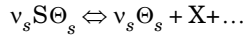

with a reaction rate k (SI unit: $\text{mol}/(\text{s}\cdot\text{m}^2)$). The signs v_s is here positive, and the reaction rate is defined as positive for reactions going from left to right.

The concentration of Θ_s does not have to be solved for because the total concentration of reaction sites, $c_{s, \text{max}}$, is assumed to be constant, implying that

$$c_{\Theta_s} = c_{s, \text{max}} - c_s$$

An important parameter for intercalation electrodes is the state-of-charge variable soc for the solid particles, defined as

$$\text{soc} = \frac{c_s}{c_{s, \max}}$$

The equilibrium potentials E_{eq} of intercalation electrodes reactions are typically functions of the soc .

The reactions occur on the particle surface only, but the intercalant species can be transported within the particles by diffusion. Within the particles the mass balance can be written as

$$\frac{\partial c_s}{\partial t} = -\nabla \cdot (-D_s \nabla c_s)$$

where c_s is the concentration of the intercalating species. This equation is solved locally by this physics interface in a 1D extra (pseudo) dimension, using a finite element discretization with the solid phase concentration as dependent variable. The divergence and gradient operator in the above equation are applied using either spherical, cylindrical, or Cartesian coordinates, depending on the particle type (spheres, cylinders, or flakes).

The boundary conditions are as follows:

$$\begin{aligned} \frac{\partial c_s}{\partial r} &= 0 \Big|_{r=0} \\ -D_s \frac{\partial c_s}{\partial r} &= R_{s, \text{tot}} \Big|_{r=r_p} \end{aligned}$$

where $R_{s, \text{tot}}$ is the total surface molar flux of the intercalating species due to the electrochemical and chemical reactions.

The stoichiometric notations used in the physics interface are according to the general electrochemical reaction as expressed below:

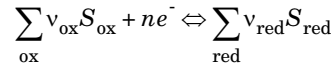

where the *stoichiometric coefficients*, v_i , are positive (v_{ox}) for products and negative (v_{red}) for reactants in a reduction reaction. From this definition, the number of electrons, n , in the electrode reaction can be calculated according to

$$n = -\sum_i z_i \nu_i$$

where z_i denotes the charge of species i .

In the porous electrodes, i_{tot} denotes the sum of all charge transfer current density contributions according to:

$$i_{\text{tot}} = \sum A_{v,m} i_{\text{loc},m}$$

where A_v denotes the specific surface. The source term in the mass balance is calculated from:

$$R_{l,p} = -\sum_m A_{v,m} \frac{\nu_{\text{Cat}^+,m} i_{\text{loc},m}}{n_m F}$$

It is also possible to specify additional reaction sources, $R_{l,\text{src}}$, that contribute to the total species source according to:

$$R_l = R_{l,p} + R_{l,\text{src}}$$

At the surface of the solid particles you have that

$$R_{s,\text{electrochem}} = -\sum_m \frac{\nu_{s\ominus,m} i_{\text{loc},m}}{n_m F} \frac{A_{v,m}}{(N_{\text{shape}} \varepsilon_s) / r_p}$$

where the last factor (normally equal to 1) is a scaling factor accounting for differences between the surface area ($A_{v,m}$) used to calculate the volumetric current density, and the surface area of the particles in the solid lithium diffusion model. N_{shape} is 1 for Cartesian, 2 for cylindrical, and 3 for spherical coordinates.

The surface area is commonly derived from the electrode volume fraction, particle size and shape according to

$$A_{v,m} = \frac{N_{\text{shape}} \varepsilon_s}{r_p}$$

If the solid phase diffusion coefficient is very large and/or if the spatial concentration gradients in the particle can be neglected, the solid phase concentration evolution in time can be calculated from

$$\frac{\partial \varepsilon_s c_s}{\partial t} = R_{v, \text{tot}}$$

The molar source, $R_{v, \text{tot}}$, due to the electrochemical and chemical reactions at the positive and negative electrodes is given as follows:

$$R_{v, \text{tot}} = -\sum_m \frac{v_{s\Theta, m} A_{v, m} i_{\text{loc}, m}}{n_m F} - \sum_m v_{s, m} A_{v, m} k_m$$

A *resistive film* (also called *solid-electrolyte interface, SEI*) might form on the solid particles resulting in additional potential losses in the electrodes. To model a film resistance, an extra solution variable for the potential variation over the film, $\Delta\phi_{s, \text{film}}$, is introduced in the physics interface. The governing equation is then according to

$$\Delta\phi_{s, \text{film}} = i_{\text{tot}} R_{\text{film}}$$

where R_{film} (SI unit: $\Omega \cdot \text{m}^2$) denotes a generalized film resistance. The activation overpotentials, η_m , for all electrode reactions in the electrode then receives an extra potential contribution, which yields

$$\eta_m = \phi_s - \Delta\phi_{s, \text{film}} - \phi_l - E_{\text{eq}, m}$$

It is also possible to model an electrode reaction at the interface between an electrolyte and a solid conductor. Typically a reaction of interest could be

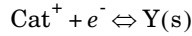

where Y could be some metal deposited on the electrode surface. Because this is not an insertion reaction, c_s is of no relevance at this boundary. The stoichiometric coefficients for the above reaction are:

$$\begin{aligned} v_{\text{Cat}^+} &= -1 \\ v_{\text{An}} &= 0 \end{aligned}$$

This results in the following boundary condition for the species flux at the electrode - electrolyte interface

$$\mathbf{n} \cdot \mathbf{N}_l = -\sum_m \frac{v_{\text{Cat}^+, m} i_m}{n_m F}$$

and the following condition for the currents:

$$\begin{aligned}i_{\text{tot}} &= \sum i_m \\ \mathbf{i}_l \cdot \mathbf{n} &= i_{\text{tot}} \\ \mathbf{i}_s \cdot \mathbf{n} &= -i_{\text{tot}}\end{aligned}$$

where the normal vector \mathbf{n} points into the electrolyte domain.

CELL CAPACITY AND STATE OF CHARGE

See [Cell Capacity and State of Charge](#) in [Theory for the Lithium-Ion Battery Interface](#).

DEFINING INITIAL CELL CHARGE DISTRIBUTIONS BASED ON CELL VOLTAGE OR CELL STATE OF CHARGE

See [Defining Initial Cell Charge Distributions Based on Cell Voltage or Cell State of Charge](#) in [Theory for the Lithium-Ion Battery Interface](#).

Theory for the Lead–Acid Battery Interface

The [Lead–Acid Battery Interface](#) uses *concentrated electrolyte theory* to model electrolyte transport and electrodes of changing porosity in a lead-acid battery. The physics interface solves for the electrolyte salt concentration, electrode porosities, electrolyte potential, and electrode potential. The notations for these dependent variables are the following:

- c_l , dissociated salt concentration of electrolyte, here $\text{H}^+/\text{HSO}_4^-$,
- ε , porosity (volume fraction of liquid electrolyte) of the porous electrodes,
- ϕ_l , electrolyte potential, and
- ϕ_s , electric potential in the electrodes.

A lead–acid cell typically consists of five parts: a positive porous electrode (PbO_2), a reservoir of electrolyte, a porous separator, a negative porous electrode (Pb), and two current collectors/feeders in contact with the positive porous electrode and negative porous electrode, respectively.

In this section:

- [The Electrode Reactions Equations](#)
- [Electrode Kinetics and Active Available Surface Areas](#)
- [Electrode Charge Transport Equations](#)
- [Electrolyte Transport Equations](#)

The Electrode Reactions Equations

The main electrode reaction in the positive (PbO_2) electrode is

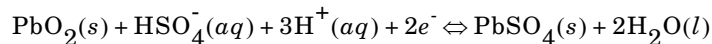

and in the negative (Pb) electrode

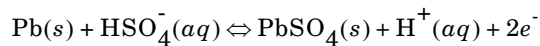

During discharge of the battery the direction of the reactions are from left to right.

Electrode Kinetics and Active Available Surface Areas

The electrode kinetics, described using the Butler–Volmer expression, depends on the electrolyte concentration according to the following:

$$i_{\text{loc}} = i_0 \left(\frac{c_l}{c_{l,\text{ref}}} \right)^\gamma \left(\exp\left(\frac{\alpha_a F \eta}{RT}\right) - \exp\left(\frac{-\alpha_c F \eta}{RT}\right) \right)$$

where i_0 denotes the exchange current density (SI unit: A/ m²), γ the reaction order (dimensionless), α_a the anodic charge transfer coefficient (dimensionless), α_c the cathodic charge transfer coefficient (dimensionless). The overpotential, η , is according to the following equation:

$$\eta = \phi_s - \phi_l - E_{\text{eq}}$$

During a discharge, the active surface area, a_v (SI unit: m²/ m³), is calculated using the equation below:

$$a_v = a_{v,\text{max}} \left(\frac{\varepsilon - \varepsilon_0}{\varepsilon_{\text{max}} - \varepsilon_0} \right)^\zeta$$

where ζ is a *morphology correction parameter* (dimensionless). This surface area can also be used for side-reactions such as oxygen evolution and oxygen reduction and the nonfaradaic double-layer currents.

In the charging reactions, PbSO₄ is a reactant but also an insulator, reducing the available active surface area. To account for this effect, the following expression can be used for the active surface area for the charging reactions:

$$a_{v,\text{charge}} = a_{v,\text{max}} \left(\frac{\varepsilon - \varepsilon_0}{\varepsilon_{\text{max}} - \varepsilon_0} \right)^\zeta \left(\frac{\varepsilon_{\text{max}} - \varepsilon}{\varepsilon_{\text{max}} - \varepsilon_0} \right)$$

Electrode Charge Transport Equations

Ohm's law describes the transport of charge in the electrode's current collectors and feeders:

$$\mathbf{i}_s = -\sigma_s \nabla \phi_s$$

In the porous electrode domains the following expression is used:

$$\mathbf{i}_s = -\varepsilon^{\text{exm}} \sigma_s \nabla \phi_s$$

where ε denote the porosity of the electrode and exm is an empirical parameter that describes the correction factor for the effective transport properties.

Current conservation is described by $\nabla \cdot \mathbf{i}_s = Q_s$. Here Q_s is the sum of all current contributions.

Electrolyte Transport Equations

A modified version of Ohm's law describes the charge transport in the electrolyte. In the reservoir, the current density expression is defined as

$$\mathbf{i}_l = -\sigma_l \nabla \phi_l + \left(\frac{\sigma_l R T}{F} \right) (1 - 2t_+) \nabla \ln c_l$$

where σ_l denotes the electrolyte conductivity, R the molar gas constant, T the temperature, F Faraday's constant, and t_+ the transport number.

In the porous domains (the separator and the porous electrodes), it is defined as

$$\mathbf{i}_l = \varepsilon^{\text{ex}} (-\sigma_l \nabla \phi_l) + \varepsilon^{\text{ex}} \left(\frac{\sigma_l R T}{F} \right) (1 - 2t_+) \nabla \ln c_l$$

Current conservation is described by $\nabla \cdot \mathbf{i}_l = Q_l$. Here Q_l denotes the sum of all current contributions.

The dissociated salt ions can be transported due to convection, migration, and diffusion. The molar flux vector, \mathbf{N}_l , (SI unit: mol/(m².s)), is written as:

$$\mathbf{N}_l = -D \nabla c_l + \mathbf{u} c_l$$

Where D (SI unit: mol/(s/m²)) is the binary diffusion coefficient into which the migration effects are incorporated, and \mathbf{u} (SI unit: m/s) is the volume averaged velocity.

In the reservoir, the material balance equation is

$$\frac{\partial}{\partial t} c_l = \nabla \cdot (D \nabla c_l) - \mathbf{u} \cdot \nabla c_l$$

In the porous electrodes the electrochemical reactions give rise to sources in the material balance equation, resulting in

$$\varepsilon \frac{\partial}{\partial t} c_l = \nabla \cdot (\varepsilon^{\text{ex}} D \nabla c_l) - \mathbf{u} \cdot \nabla c_l + R_l$$

where R_l is the a source term (SI unit: mol/s /m³) resulting from the electrochemical reactions. This source term is according to the equation below:

$$R_l = -\sum_m \frac{a_{v,m} i_m}{n_m F} ((1 - c_l \bar{V}_e) ((1 - t_+) v_{H^+,m} + t_+ v_{HSO_4^-,m}) - c_l \bar{V}_0 v_{H_2O,m})$$

where n_m denotes the number of electrons involved in reaction (dimensionless), \bar{V}_0 the partial molar volume of the solvent (H₂O) (SI unit: m³/mol), \bar{V}_e the partial molar volume of the electrolyte (SI unit: m³/mol),

$$v_{H^+,m}$$

the stoichiometric coefficients for the proton,

$$v_{HSO_4^-,m}$$

the stoichiometric coefficient for the bisulfate ion, and

$$v_{H_2O,m}$$

the stoichiometric coefficient for water in reaction m .

In the separator, the corresponding transport equation is used for the electrolyte, but where the source term, R_l , is zero.

For a boundary, the flux of electrolyte species due to the electrochemical reactions is calculated according to

$$\mathbf{n} \cdot \mathbf{N}_l = -\sum_m \frac{i_m}{n_m F} ((1 - t_+) v_{H^+,m} + t_+ v_{HSO_4^-,m})$$

As the solid material in the electrodes react, the porosity changes due to volume changes. This is described by the equation below:

$$\frac{\partial \varepsilon}{\partial t} = \sum_m \frac{a_{v,m} i_m}{n_m F} (v_{Pb,m} \bar{V}_{Pb} + v_{PbO_2,m} \bar{V}_{PbO_2} + v_{PbSO_4,m} \bar{V}_{PbSO_4})$$

where \bar{V}_i denotes the molar volumes (SI unit: m³/mol) for the solid materials in the electrodes,

$$v_{Pb,m}$$

the stoichiometric coefficient of lead,

$$v_{\text{PbO}_2, m}$$

the stoichiometric coefficient of lead oxide, and

$$v_{\text{PbSO}_4, m}$$

the stoichiometric coefficient for lead sulfate in reaction m . For a species with a known density, ρ_i (SI unit: kg/m^3), and molar mass M_i it can be calculated as

$$\bar{V}_i = \frac{M_i}{\rho_i}$$

In the separator the porosity is constant.

For results and analysis purposes the following state-of-charge expression, soc, for the electrodes, is also defined

$$\text{soc} = \left(\frac{\varepsilon - \varepsilon_0}{\varepsilon_{\text{max}} - \varepsilon_0} \right)$$

Assuming that the main Pb and PbO_2 reactions are the main contributions to the currents in each electrode, the average superficial velocity in each electrode compartment can be calculated as

$$\mathbf{u}_{\text{PbO}_2} = -\frac{\mathbf{i}_l}{2F}((\bar{V}_{\text{PbSO}_4} - \bar{V}_{\text{PbO}_2} - (3 - 2t_+) \bar{V}_e + 2\bar{V}_0))$$

and

$$\mathbf{u}_{\text{Pb}} = -\frac{\mathbf{i}_l}{2F}(\bar{V}_{\text{Pb}} - \bar{V}_{\text{PbSO}_4} - (1 - 2t_+) \bar{V}_e)$$

Because the reservoir is normally adjacent to the positive PbO_2 electrode,

$$\mathbf{u} \approx \mathbf{u}_{\text{PbO}_2}$$

is usually a good approximation in the reservoir and

$$\mathbf{u} \approx \mathbf{u}_{\text{Pb}}$$

can be used in the separator.

These assumptions result in a noncontinuous velocity, and hence a noncontinuous convection contribution to the electrolyte transport, at the interface between the

separator and reservoir domains. The physical background to this is that as water is either consumed or created at the positive electrode during charge or discharge, the liquid level in the reservoir either rises or falls. However, the combination of low velocities and moderate concentration gradients at the separator/reservoir interface makes these velocity approximations acceptable in most cases.

Theory for the Single Particle Battery Interface

The **Single Particle Battery Interface** models the charge distribution in a battery by accounting for solid diffusion in the electrode particles and the intercalation reaction kinetics. The ohmic potential drop in the electrolyte is included in the model using a lumped solution resistance term.

The cell potential E_{cell} (SI unit: V) is defined as

$$E_{\text{cell}} = \phi_{s,\text{pos}} - \phi_{s,\text{neg}} = E_{\text{pos}} - E_{\text{neg}} + \Delta\phi_l$$

where $\phi_{s,\text{pos}}$ and $\phi_{s,\text{neg}}$ are the potentials of the electron conducting phase (one for each electrode), E_{pos} and E_{neg} are the electrode potentials, and $\Delta\phi_l$ is the potential drop over the electrolyte phase separating the electrodes.

The battery cell current density, i_{cell} (SI unit: $\text{A}\cdot\text{m}^{-2}$), is defined as

$$i_{\text{cell}} = \frac{\Delta\phi_l}{R_{\text{sol}}}$$

where R_{sol} (SI unit: $\Omega\cdot\text{m}^2$) is the solution resistance.

For the global formulation, the potential drop in the electrolyte solution phase is obtained by the relation

$$A_{\text{sep}} i_{\text{cell}} = I_{\text{cell}}$$

where A_{sep} (SI unit: m^2) is the separator cross-sectional area and I_{cell} (SI unit: A) is the battery cell current.

For the local formulation, the following relation is used

$$A_{\text{sep}} \frac{\int_{\Omega} i_{\text{cell}} d_{\text{vol}} d\Omega}{V_{\text{cell}}} = I_{\text{cell}}$$

where V_{cell} is the cell volume and Ω is the selected domain where the single particle interface is active. Note that d_{vol} is the cell cross-sectional area in 1D, the out-of-plane-thickness in 2D and 1D with axial symmetry, and is equal to 1 in 3D and

2D with axial symmetry space dimensions. In 1D with axial symmetry and 2D with axial symmetry, the expressions computing the volume integrals are also multiplied by $2\pi r$.

The separator area A_{sep} can be calculated from the following relation if the separator thickness L_{sep} and the volume fraction ϵ_{sep} occupied by the separator in the battery are known

$$A_{\text{sep}} = \frac{\epsilon_{\text{sep}} V_{\text{cell}}}{L_{\text{sep}}}$$

The solution resistance in the separator $R_{\text{sol,sep}}$ can be calculated from the separator thickness and the effective electrolyte conductivity $\sigma_{l,\text{eff}}$ (accounts for separator porosity correction) as follows:

$$R_{\text{sol,sep}} = \frac{L_{\text{sep}}}{\sigma_{l,\text{eff}}}$$

To compensate for the contributions to the ohmic resistance from the electrolyte potential drop in the electrodes, the above can also be multiplied by a fraction number X , typically greater than 1,

$$R_{\text{sol}} = XR_{\text{sol,sep}}$$

The charge balance for each electrode is as follows for the global case:

$$\pm I_{\text{cell}} = V_{\text{electrode}} \left(\sum_m A_{v,m} i_{\text{loc},m} + A_{v,\text{dl}} i_{\text{dl}} \right)$$

where $V_{\text{electrode}}$ is the porous electrode volume, i_{loc} is the local intercalation current density, i_{dl} is the double-layer current density, and A_v denotes the active specific surface area.

For the local formulation, the charge balance is given as

$$\pm i_{\text{cell}} \frac{A_{\text{sep}}}{V_{\text{cell}}} = \epsilon_{\text{electrode}} \left(\sum_m A_{v,m} i_{\text{loc},m} + A_{v,\text{dl}} i_{\text{dl}} \right)$$

where $\epsilon_{\text{electrode}}$ is the porous electrode volume fraction in the battery.

In the above equations, the +sign applies for the positive electrode and the -sign applies for the negative electrode. In this interface, charge currents are positive and discharge currents are negative.

Diffusion in the active material particles in the positive and negative electrodes is described by Fick's second law as

$$\frac{\partial c_s}{\partial t} = -\nabla \cdot (-D_s \nabla c_s)$$

where c_s is the concentration of the intercalating species in the solid phase and D_s is the solid phase diffusion coefficient. The diffusion equation is solved either globally or locally (depending on the selection of either global or local formulation, respectively) by this physics interface in a 1D pseudo extra dimension corresponding to the particle dimension. The gradient is calculated in Cartesian, cylindrical, or spherical coordinates, depending on if the particles are assumed to be best described as flakes, rods, or spheres, respectively.

The boundary conditions at the center and surface of the particle are as follows:

$$\begin{aligned} \frac{\partial c_s}{\partial r} &= 0 \Big|_{r=0} \\ -D_s \frac{\partial c_s}{\partial r} &= -R_{s\ominus} \Big|_{r=r_p} \end{aligned}$$

where r_p is the radius of the electrode active material particle and $R_{s\ominus}$ denotes the molar flux of the cation at the particle surface, caused by the electrochemical insertion reactions.

At the surface of the solid particles, the molar flux is coupled to the rate of the lithium intercalation reaction and the following equation applies:

$$R_{s\ominus} = -\sum_m \frac{v_{s\ominus, m} i_{loc, m}}{n_m F} \frac{A_{v, m}}{(N_{shape} \varepsilon_s) / r_p}$$

where the last factor (normally equal to 1) is a scaling factor accounting for differences between the surface area ($A_{v, m}$) used to calculate the volumetric current density, and the surface area of the particles in the solid lithium diffusion model. $v_{s\ominus}$ denotes the stoichiometric coefficient of the intercalating species in the electrode particles, n_m is the number of transferred electrons, and ε_s is the volume fraction of the electrode

phase in the porous electrode. N_{shape} is 1 for Cartesian, 2 for cylindrical, and 3 for spherical coordinates.

If the solid phase diffusion coefficient is very large and/or if the spatial concentration gradients in the particle can be neglected, the solid phase concentration evolution in time can be calculated from

$$\frac{\partial \varepsilon_s c_s}{\partial t} = R_{v\Theta}$$

The molar source $R_{s\Theta}$ at the positive and negative electrodes is given as follows:

$$R_{v\Theta} = -\sum_m \frac{v_{s\Theta, m} A_{v, m} i_{10c, m}}{n_m F}$$

BATTERY CELL VOLUME, ELECTRODE HOST CAPACITIES AND VOLUME FRACTIONS

In 0D the battery cell volume V_{cell} is specified by the user. In higher dimensions, the cell volume V_{cell} , is defined according to

$$V_{\text{cell}} = \int_{\Omega} d_{\text{vol}} d\Omega$$

where Ω is the selected domain where the single particle interface is active, and d_{vol} is the cell cross-sectional area in 1D, the out-of-plane-thickness in 2D and 1D with axial symmetry, and is equal to 1 in 3D and 2D with axial symmetry space dimensions. In 1D with axial symmetry and 2D with axial symmetry, the expressions computing the volume integrals are also multiplied by $2\pi r$. Note that for some cases, V_{cell} is explicitly only needed to calculate the heat source variables.

The porous electrode volume $V_{\text{electrode}}$ is related to the cell volume according to

$$V_{\text{electrode}} = \varepsilon_{\text{electrode}} V_{\text{cell}}$$

The electrode host capacities are related to the electrode volume fractions. For the global formulation, the following relation holds for the amount of active host material Q_{host} (SI unit: C):

$$Q_{\text{host}} = V_{\text{electrode}} \varepsilon_s \Delta \text{soc}_{s, \max} F$$

where Δsoc is the allowed state-of-charge window of the electrode material and $c_{s,\text{max}}$ is the maximum concentration of the intercalating species.

For the local formulation, the following relation applies:

$$Q_{\text{host}} = \varepsilon_{\text{electrode}} \int_{\Omega} \varepsilon_s \Delta\text{soc} c_{s,\text{max}} F d_{\text{vol}} d\Omega$$

In this interface, the electrode host capacities can be specified by either providing the amount of cyclable material (cell capacity) and a balancing relation between the two electrodes, or by explicitly providing the electrode volume fractions in the cell. The amount of cyclable species is assumed to originate from the positive electrode material. In some battery chemistries, for instance lithium-ion batteries, the host material amount in both electrodes deviate. Negative carbon-based electrodes lithium-ion batteries are for instance often applied in excess compared to the positive electrode in order to avoid lithium metal plating during high rate charging. Cyclable species can in some cases be lost directly during the first “formation” cycles after cell assembly due to parasitic reactions. A typical example is the forming of the SEI layer on the negative graphite particles in lithium-ion batteries. The following relations therefore apply:

$$Q_{\text{host,pos}} = \frac{Q_{\text{cell},0}}{1 - f_{\text{cycl,loss}}}$$

$$Q_{\text{host,neg}} = (1 + f_{\text{host,neg,ex}}) Q_{\text{host,pos}}$$

where $f_{\text{cycl,loss}}$ the fractional loss of cyclable species, and $f_{\text{host,neg,ex}}$ the fractional excess of negative active host material.

INITIAL CHARGE DISTRIBUTION IN THE BATTERY CELL

The initial state of charge of the battery is explicitly determined by the initial concentration values of the active species in each electrode. These concentration levels are however not always known a priori. A Current Distribution Initialization study step may be used to calculate the initial concentration levels of two electrodes based on the input in the Initial Charge Distribution section. The initial cell state of charge, cell voltage, or the (individual) electrode state of charges can be specified.

The battery cell capacity, $Q_{\text{cell},0}$ (SI unit: C), is equal to the sum of the charge of cyclable species, Q_{cycl} , in the positive and negative electrodes.

$$Q_{\text{cell},0} = Q_{\text{cycl,pos}} + Q_{\text{cycl,neg}}$$

The cyclable species charge Q_{cycl} in an electrode is defined as follows, for the global formulation,

$$Q_{\text{cycl}} = V_{\text{electrode}} \varepsilon_s (c_{s,\text{avg}} - \text{soc}_{\text{min}} c_{s,\text{max}}) F$$

where $c_{s,\text{avg}}$ is the average species concentration, which initially, when no concentration gradients are present within the electrode particles, is equal to the concentration at the surface of the electrode particles, $c_{s,\text{surf}}$. soc_{min} is the minimum allowed state of charge in the electrode material.

For the local formulation, the following relation holds:

$$Q_{\text{cycl}} = \varepsilon_{\text{electrode}} \int_{\Omega} \varepsilon_s (c_{s,\text{avg}} - \text{soc}_{\text{min}} c_{s,\text{max}}) F d_{\text{vol}} d\Omega$$

In case of the user input being the initial cell state of charge $\text{soc}_{\text{cell},0}$, the cyclable amount of species in each electrode is related to the cell capacity as follows:

$$Q_{\text{cycl,neg}} = Q_{\text{cell},0} \text{soc}_{\text{cell},0}$$

$$Q_{\text{cycl,pos}} = Q_{\text{cell},0} (1 - \text{soc}_{\text{cell},0})$$

The cell state-of-charge ranges between 0 and 1. A state of charge of 0 indicates that the cell is completely discharged and if it is 1 the cell is fully charged.

In case of the user input being the initial cell voltage $E_{\text{cell},0}$, the following relation applies for the global formulation,

$$E_{\text{cell},0} = E_{\text{cell}} = E_{\text{pos}} - E_{\text{neg}} + \Delta\phi_l$$

For the local formulation, the following relation holds:

$$A_{\text{sep}} \frac{\int_{\Omega} ((E_{\text{cell},0} - E_{\text{pos}} + E_{\text{neg}}) / R_{\text{sol}}) d_{\text{vol}} d\Omega}{V_{\text{cell}}} = I_{\text{cell}}$$

If the individual initial electrode operational state of charges ($\text{soc}_{\text{op,pos},0}$ and $\text{soc}_{\text{op,neg},0}$) are specified, the following relations apply:

$$Q_{\text{cycl,neg}} = Q_{\text{host,neg}} \text{soc}_{\text{op,neg},0}$$

$$Q_{\text{cycl,pos}} = Q_{\text{host,pos}} \text{soc}_{\text{op,pos},0}$$

ELECTROCHEMICAL HEAT SOURCES

In order to model the energy balance of an electrochemical cell, a Heat Transfer interface is used to model the heat transport and the Single Particle Battery interface is used to generate the heat sources and sinks due to the electrochemical currents.

The expressions for the heat sources in the porous negative/positive electrode (due to the electrochemical reaction) $Q_{h,\text{electrode}}$ (SI unit: W/m^3) is as follows:

$$Q_{h,\text{electrode}} = \varepsilon_{\text{electrode}} \sum_m A_{v,m} i_{\text{loc},m} \left(E - E_{\text{eq},m} + T \frac{\partial E_{\text{eq},m}}{\partial T} \right)$$

The ohmic heating in the electrolyte phase $Q_{h,\text{sol}}$ (SI unit: W/m^3) is

$$Q_{h,\text{sol}} = \frac{\Delta\phi_l i_{\text{cell}} A_{\text{sep}}}{V_{\text{cell}}}$$

The total volumetric cell heat source $Q_{h,\text{cell}}$ (SI unit: W/m^3) can be written as

$$Q_{h,\text{cell}} = Q_{h,\text{neg}} + Q_{h,\text{pos}} + Q_{h,\text{sol}}$$

Theory for the Lumped Battery Interface

The **Lumped Battery Interface** makes use of a small set of lumped parameters for adding contributions for the sum of all voltage losses in the battery, stemming from ohmic resistances and (optionally) charge transfer or diffusion processes.

Generally, the battery cell voltage E_{cell} (SI unit: V) is defined as

$$E_{\text{cell}} = E_{\text{OCV}}(\text{SOC}, T) + \eta_{\text{IR}} + \eta_{\text{act}} + \eta_{\text{conc}}$$

where η_{IR} is the ohmic overpotential, η_{act} is the activation overpotential, and η_{conc} is the concentration overpotential. E_{OCV} is the cell open circuit voltage which is dependent on the state of charge SOC and temperature T according to,

$$E_{\text{OCV}}(\text{SOC}, T) = E_{\text{OCV,ref}}(\text{SOC}) + (T - T_{\text{ref}}) \frac{\partial E_{\text{OCV}}(\text{SOC})}{\partial T}$$

where $E_{\text{OCV,ref}}$ is the open circuit voltage at a reference temperature T_{ref} .

The time evolution of *SOC* is defined as

$$\frac{\partial \text{SOC}}{\partial t} = \frac{I_{\text{cell}}}{Q_{\text{cell}}}$$

where I_{cell} (SI unit: A) is the applied current and Q_{cell} (SI unit: C) is the battery cell capacity that is set equal to the initial battery cell capacity $Q_{\text{cell},0}$ (SI unit: C). The initial cell state of charge is specified by $\text{SOC}_{\text{cell},0}$. If the concentration overpotential is calculated based on particle diffusion, SOC is replaced by the average state of charge, $\text{SOC}_{\text{average}}$, in both the above equations.

The lumped voltage loss associated with ohmic process in the electrolyte and electrodes is given as

$$\eta_{\text{IR}} = \eta_{\text{IR},1\text{C}} \frac{I_{\text{cell}}}{I_{1\text{C}}}$$

where $\eta_{\text{IR},1\text{C}}$ is the ohmic overpotential at 1C, and

$$I_{1C} = \frac{Q_{\text{cell},0}}{3600 \text{ s}}$$

The lumped voltage loss associated with activation overpotential on both the positive and negative electrode surfaces is defined as

$$\eta_{\text{act}} = \frac{2RT}{F} \operatorname{asinh}\left(\frac{I_{\text{cell}}}{2J_0 I_{1C}}\right)$$

where R denotes the molar gas constant, T the temperature, F Faraday's constant, and J_0 the dimensionless charge exchange current.

For fast transients or for frequency domain simulations, it may also be of interest to include the double-layer capacitance between the electrode and electrolyte phases in the battery. In this case, one cannot derive an analytical expression for the activation overpotential. Instead, the activation overpotential is solved for as a dependent variable fulfilling

$$I_{\text{cell}} = I_{\text{ct}} + I_{\text{dl}}$$

where I_{ct} is the charge transfer current and I_{dl} is the double-layer current. They are defined as

$$I_{\text{ct}} = J_0 I_{1C} \left(\exp\left(\frac{\eta_{\text{act}} F}{2RT}\right) - \exp\left(\frac{-\eta_{\text{act}} F}{2RT}\right) \right)$$

and

$$I_{\text{dl}} = I_{1C} C_{\text{dl},1C} \frac{\partial \eta_{\text{act}}}{\partial t}$$

where the normalized 1C double-layer capacitance, $C_{\text{dl},1C}$, relates the double-layer current to the time derivative of activation potential. Note that the above equation assumes that the time derivative of the equilibrium potential is orders of magnitude lower than the time derivative of the activation potential.

Concentration overpotential effects can be modeled either based on diffusion in an idealized particle or by using an RC pair (a linear resistor coupled in parallel with a capacitor). In the former case, Fickian diffusion of a dimensionless SOC variable is solved for in 1D on an interval of length 1 with X as the dimensionless spatial variable according to

$$\tau \frac{\partial \text{SOC}}{\partial t} = -\nabla \cdot (-\nabla \text{SOC})$$

where τ is the diffusion time constant. The diffusion equation is solved either globally or locally (depending on the selection of either global or local formulation, respectively) in a 1D pseudo extra dimension corresponding to the particle dimension. The gradient is calculated in Cartesian, cylindrical, or spherical coordinates, depending on if the particles are assumed to be best described as flakes, rods, or spheres, respectively.

The boundary conditions at the center and surface of the particle are as follows:

$$\begin{aligned} \nabla \text{SOC} &= 0 \Big|_{X=0} \\ \nabla \text{SOC} &= \frac{\tau I_{\text{cell}}}{N_{\text{shape}} Q_{\text{cell}}} \Big|_{X=1} \end{aligned}$$

where N_{shape} is 1 for Cartesian, 2 for cylindrical, and 3 for spherical coordinates. The initial cell state of charge is specified by $\text{SOC}_{\text{cell},0}$. The surface state of charge, $\text{SOC}_{\text{surface}}$, is defined at the surface of the particle. The average state of charge, $\text{SOC}_{\text{average}}$, is defined by integrating over the volume of the particle, appropriately considering Cartesian, cylindrical, or spherical coordinates. Note that, as mentioned above, $\text{SOC}_{\text{average}}$ is used in the definition of E_{cell} .

The lumped voltage loss associated with concentration overpotential is defined as

$$\eta_{\text{conc}} = E_{\text{OCV}}(\text{SOC}_{\text{surface}}, T) - E_{\text{OCV}}(\text{SOC}_{\text{average}}, T)$$

For the latter case, where the concentration overpotential calculation is done using an RC pair, η_{conc} is defined as

$$RC \frac{\partial \eta_{\text{conc}}}{\partial t} + \eta_{\text{conc}} = RI_{\text{cell}}$$

where the RC time constant, $\tau_{RC} = RC$, and the RC potential at 1C, $E_{\text{RC},1C} = RI_{1C}$.

BATTERY CELL VOLUME

In 0D, the battery cell volume V_{cell} is specified by the user. In higher dimensions, the cell volume V_{cell} , is defined according to

$$V_{\text{cell}} = \int_{\Omega} d_{\text{vol}} d\Omega$$

where Ω is the selected domain where the Lumped Battery interface is active, and d_{vol} is the cell cross-sectional area in 1D, the out-of-plane-thickness in 2D and 1D with axial symmetry, and is equal to 1 in 3D and 2D with axial symmetry space dimensions. In 1D with axial symmetry and 2D with axial symmetry, the expressions computing the volume integrals are also multiplied by $2\pi r$. Note that for some cases, V_{cell} is explicitly only needed to calculate the heat source variables.

ELECTROCHEMICAL HEAT SOURCES

In order to model the energy balance of an electrochemical cell, a Heat Transfer interface is typically used to model the heat transport and the Lumped Battery interface is used to generate the heat sources and sinks due to the electrochemical currents.

The battery heat source (SI unit: W) is defined as follows, if concentration overpotential is not included:

$$Q_h = \left(\eta_{\text{IR}} + \eta_{\text{act}} + T \frac{\partial E_{\text{OCV}}(\text{SOC}, T)}{\partial T} \right) I_{\text{cell}}$$

If concentration overpotential is included and modeled based on diffusion in an idealized particle, the battery heat source (SI unit: W) is defined as

$$Q_h = \left(\eta_{\text{IR}} + \eta_{\text{act}} + T \frac{\partial E_{\text{OCV}}(\text{SOC}_{\text{surface}}, T)}{\partial T} \right) I_{\text{cell}} + Q_{\text{mix}}$$

where the heat of mixing, Q_{mix} , is defined as

$$Q_{\text{mix}} = \frac{N_{\text{shape}} Q_{\text{cell}}}{\tau} \int_0^1 \frac{\partial E_{\text{OCV,therm}}}{\partial \text{SOC}} \frac{\partial \text{SOC}}{\partial X} \frac{\partial \text{SOC}}{\partial X} X^{N_{\text{shape}} - 1} \partial X$$

with the thermoneutral voltage, $E_{\text{OCV,therm}}$, given as

$$E_{\text{OCV,therm}} = E_{\text{OCV,ref}}(\text{SOC}) - T_{\text{ref}} \frac{\partial E_{\text{OCV}}(\text{SOC})}{\partial T}$$

If concentration overpotential is included by using an RC pair, the battery heat source (SI unit: W) is defined as

$$Q_h = \left(\eta_{\text{IR}} + \eta_{\text{act}} + T \frac{\partial E_{\text{OCV}}(\text{SOC}, T)}{\partial T} \right) I_{\text{cell}} + Q_{\text{mix}}$$

where Q_{mix} is defined as

$$Q_{\text{mix}} = \frac{\eta_{\text{conc}}^2}{R}$$

CAPACITY LOSS

Capacity loss in batteries is a complex process, encompassing a multiple of different phenomena. Depending on the battery chemistry, the aging mechanisms will be different.

The accumulated charge corresponding to the parasitic reactions Q_{loss} can be written as

$$\frac{\partial Q_{\text{loss}}}{\partial t} = I_{\text{loss}}$$

where I_{loss} (SI unit: A) is the loss current. The initial battery loss capacity is set to 0. The remaining battery cell capacity Q_{cell} (SI unit: C) is defined as

$$Q_{\text{cell}} = Q_{\text{cell},0} - Q_{\text{loss}}$$

Using a lumped modeling approach, assuming limited knowledge about the internal processes occurring inside the battery, any aging model will have to be empirical, not being able to discriminate between different phenomena. Typically, capacity loss and aging may be affected by the battery voltage, the capacity throughput, aging history and temperature. To define a lumped aging rate we may write the sum of all parasitic currents in the battery, resulting in a capacity loss, as

$$I_{\text{loss}} = \frac{Q_{\text{cell},0}}{\tau_{\text{loss}}} f_{\text{E}} f_{\text{I}} f_{\text{aged}} f_{\text{T}}$$

where, τ_{loss} is a calendar aging time constant defining the rate of the parasitic reactions. The factors f_{E} , f_{I} , f_{aged} , and f_{T} are dimensionless aging factors, depending on the battery voltage, battery current, aging history and temperature, respectively. Setting all aging factors to 1 would result in a constant capacity loss from $t = 0$, reaching 0 remaining capacity when $t = \tau_{\text{loss}}$, independent of battery SOC, capacity throughput, aging history and temperature.

In many battery systems, it has been seen that high SOC values accelerate capacity loss. Since a high SOC typically also results in a high battery voltage, one way of defining f_{E} for such systems is hence

$$f_E = \exp\left(\frac{\alpha F(E_{OCV}(SOC, T) + \eta_{act} - \overline{E}_{OCV}(T) - E_{offset})}{RT}\right)$$

f_E defined as above would correspond either to a parasitic electrochemical reduction reaction occurring on the negative electrode, or an oxidation reaction occurring on the positive electrode. The transfer coefficient α and offset potential E_{offset} parameters relate how the rate of the parasitic reactions changes when the battery voltage deviates from the average open circuit voltage, $\overline{E}_{OCV}(T)$, defined as

$$\overline{E}_{OCV}(T) = \int_0^1 E_{OCV}(SOC, T) \partial SOC$$

For many battery systems it is also often observed that the lifetime is closely related to the amount of cycled equivalent full cycles (capacity throughput). A current dependence term, resulting in a linear relation between the capacity fade and the number of full cycles may be defined as

$$f_I = \left(1 + H \frac{\tau_{loss} |I_{cell}|}{2Q_{cell,0}}\right)$$

where H defines the additional (dimensionless) capacity loss induced by cycling. Note that $2Q_{cell,0}$ corresponds to the capacity throughput of one full charge-discharge cycle.

The rate of the capacity fade may be slowed down as a result of products formed by the parasitic reactions, for example by the formation of a mass transport limiting film on the electrode particles. One way of defining a decelerating aging rate is to use the following definition of f_{aged} :

$$f_{aged} = \frac{1}{1 + (G - 1) \frac{Q_{loss}}{Q_{cell,0}}}$$

where G defines how many times the capacity fade rate has been reduced when all capacity has been lost.

Finally, temperature is also known to be a crucial factor for aging. The temperature factor f_T is defined using an Arrhenius expression according to

$$f_T = \exp\left(-\frac{E_a}{R} \left(\frac{1}{T} - \frac{1}{T_{ref}}\right)\right)$$

where E_a is the activation energy and T_{ref} is a reference temperature.

Finally, it is reasonable to assume that the activation overpotential is not affected by the parasitic reactions, and there is no need to explicitly include the parasitic reactions when dealing with the main reaction potentials. This means that it is possible to treat the activation overpotential independently of the parasitic reactions. The following then holds good:

$$I_{\text{cell}} = I_{\text{ct}} + I_{\text{dl}} + I_{\text{loss}} \approx I_{\text{ct}} + I_{\text{dl}}$$

SHORT CIRCUIT

In order to model a short circuit scenario inside a lumped battery, with known short circuit resistance (inverse of conductance), one can use this node to define the short circuit conductance G_{short} . The short circuit current associated with this according to the Ohm's law is

$$I_{\text{short}} = E_{\text{cell}} G_{\text{short}}$$

The corresponding I_{short} is seen as a discharge current for the overall cell operation and is subtracted from the applied current:

$$I_{\text{cell}} = I_{\text{ct}} + I_{\text{dl}} - I_{\text{short}}$$

Theory for the Battery Pack Interface

For the battery models of [The Battery Pack Interface](#), refer to [Theory for the Lumped Battery Interface](#). Individual battery models are created for each disjoint set of domains in the battery selection of the interface. All variables are given an additional suffix i , where the index i ranges from 1 to N , where N is the number of disjoint sets in the selection.

In the current conductors, the electric potential in the electrode phase ϕ_s (SI unit: V) is solved for using a charge balance based on Ohm's law.

The current density, \mathbf{i}_s (SI unit: A/m²), is defined as

$$\mathbf{i}_s = -\sigma_s \nabla \phi_s$$

where σ_s is the electrical conductivity. The charge balance equation is expressed as

$$\nabla \cdot \mathbf{i}_s = 0$$

The joule heating source term Q_h (SI unit: W/m³) is defined as

$$Q_h = -(\mathbf{i}_s \cdot \nabla \phi_s)$$

The battery models, which are formulated as global 0D equations, are coupled to ϕ_s on the current collector on the negative and positive connectors ($\delta\Omega_{\text{neg},i}$ and $\delta\Omega_{\text{pos},i}$, respectively) separately for each battery i .

The coupling is achieved by defining two global electrical potential degrees of freedom $\phi_{s,\text{neg},i}$, $\phi_{s,\text{pos},i}$ and one degree of freedom for the individually applied battery current $I_{\text{app},i}$ (SI unit: A) and then solving the following set of equations.

On the negative and positive connectors, if contact resistance is not included, the following applies,

$$\phi_{s,\text{neg},i} = \phi_s$$

$$\phi_{s,\text{pos},i} = \phi_s$$

If contact resistance R_c (SI unit: $\Omega\cdot\text{m}^2$) is included on the negative and positive connectors, the following applies,

$$-\mathbf{n} \cdot \mathbf{i}_s = \frac{\phi_{s, \text{neg}, i} - \phi_s}{R_c}$$

$$-\mathbf{n} \cdot \mathbf{i}_s = \frac{\phi_{s, \text{pos}, i} - \phi_s}{R_c}$$

Additionally,

$$E_{\text{cell}, i}(I_{\text{app}, i}) = \phi_{s, \text{neg}, i} - \phi_{s, \text{pos}, i}$$

$$\int_{\delta\Omega_{\text{neg}, i}} (\mathbf{n} \cdot \mathbf{i}_s) d\delta\Omega = -I_{\text{app}, i}$$

$$\int_{\delta\Omega_{\text{pos}, i}} (\mathbf{n} \cdot \mathbf{i}_s) d\delta\Omega = I_{\text{app}, i}$$

For all subnodes to the Batteries node, except the Thermal Event subnode, refer to [Theory for the Lumped Battery Interface](#). The Thermal Event subnode is described below.

All the boundary condition subnodes of the Current Conductors node are similar to those described for the Current Distribution interfaces. See boundary nodes described in [Shared Nodes for Battery Interfaces](#).

THEMAL EVENT

The Thermal Event node can be used to define an event-based heat source. In addition, the event may also induce changes in the ohmic overpotentials (internal resistance) of the battery cells and/or induce cell short circuits.

Similarly to other nodes in the Battery Pack interface, individual events, heat sources and associated state variables are created for each battery cell (disjoint set of domains) in Thermal Event node selection.

To control the heat source released by the thermal event, an event time state variable t_{te} (SI unit: s) is used. The initial value of the event time variable is set to `inf`. The thermal event is triggered by an **Event condition**, which could be when either the maximum or average cell temperature exceeds a corresponding maximum or average trigger temperature, or if the simulated time exceeds the explicit time that is specified. When the event is triggered, the event time variable t_{te} is set to the current time t , in the case of maximum or average temperature event conditions. In the case

of explicit time event condition, the event time variable t_{te} is set to the specified explicit time t_{exp} . The event can only be triggered once per battery cell.

After the event has been triggered, the thermal event heat source $Q_{h,te}$ (SI unit: W) is added to the total sum of all heat sources for the battery cell. The heat source should be stated as a function of time elapsed after triggering of the event. Additionally, the heat sources due to the added ohmic overpotential and short circuit are also included appropriately.

DEFINING TEMPERATURE AND SOC-DEPENDENT BATTERY PARAMETERS

All battery parameters in the Battery Pack Interface, defined for instance in the [Voltage Losses](#), [Cell Equilibrium Potential](#) and [Thermal Event](#) subnodes, need to be defined using global (nonspatially resolved) values. Individual parameter dependencies, (that is, per battery cell) on temperature and SOC are possible to define by the use of the `bp.T_cell` and `bp.SOC` (without a suffix) variables. In the parameter expressions, these variables are substituted internally to the corresponding global, but individually defined `bp.T_cell_x` and `bp.SOC_x` variables, where the suffix x denotes the cell number, ranging from 1 to the number of disjoint domains.

Note that `bp.T_cell_x` is defined as the average per cell of the temperature expression under Model Input of the [Voltage Losses](#) node for each cell number x . If **Include concentration overpotential** is active using **Particle diffusion**, `bp.SOC` is substituted for the local SOC in the generalized particle in the **Diffusion time-constant** parameter expression, and the average SOC in the particle for all other parameters.

Electrochemistry Interfaces

This chapter describes the physics interfaces found under the **Electrochemistry** branch ()

In this chapter:

- [The Primary and Secondary Current Distribution Interfaces](#)
- [The Tertiary Current Distribution, Nernst-Planck Interface](#)
- [Shared Physics Features in the Current Distribution Interfaces](#)
- [The Electrode, Shell Interface](#)
- [The Electroanalysis Model Wizard Entry](#)
- [Theory for the Current Distribution Interfaces](#)
- [Theory for Electrochemical Heat Sources](#)
- [Theory for the Electrode, Shell Interface](#)
- [Theory for Electroanalysis](#)
- [Electrode Potentials and Reference Electrodes](#)

The Primary and Secondary Current Distribution Interfaces



In this section:

- [The Primary Current Distribution and Secondary Current Distribution Interfaces](#)
- [Electrolyte](#)
- [Initial Values](#)
- [Porous Electrode](#)
- [Periodic Condition](#)
- [Thin Electrolyte Layer](#)
- [Edge Electrode](#)
- [Electrode Line Current Source](#)
- [Electrolyte Line Current Source](#)
- [Electrode Symmetry Axis Current Source](#)
- [Electrolyte Symmetry Axis Current Source](#)
- [Electrode Point Current Source](#)
- [Electrolyte Point Current Source](#)



Only the physics interface-specific nodes are described here. All other nodes in the Primary Current Distribution and Secondary Current Distribution interfaces are described in [Shared Physics Features in the Current Distribution Interfaces](#)

The Primary Current Distribution and Secondary Current Distribution Interfaces

The **Primary Current Distribution (cd)** interface () and the **Secondary Current Distribution (cd)** interface () are found under the **Electrochemistry** branch () when adding a physics interface.

Primary Current Distribution Interface

The **Primary Current Distribution** interface defines the transport of charged ions in an electrolyte of uniform composition as well as current conduction in electrodes using Ohm's law in combination with a charge balance. The physics interface neglects activation overpotentials due to charge transfer reactions.

Use this physics interface to estimate the ohmic losses in simplified models of electrochemical cells, where the overpotentials of the electrode reactions are small compared to the ohmic voltage drops in the electrolyte and electrodes.

Secondary Current Distribution Interface

The **Secondary Current Distribution** interface is similar to the Primary Current Distribution interface, except that it also accounts for activation overpotentials. The relation between charge transfer and overpotential can be described using arbitrary kinetic expressions, such as Butler–Volmer and Tafel equations.

Use this physics interface for generic modeling of electrochemical cells. It can be combined with interfaces modeling mass transport to describe concentration dependent (tertiary) current distributions.

Use the **Current Distribution Type** setting on the physics interface node, described below, to switch between a Primary Current Distribution and a Secondary Current Distribution interface.



- [Introduction to Electrochemistry Modeling](#)

SETTINGS

The **Label** is the default physics interface name.

The **Name** is used primarily as a scope prefix for variables defined by the physics interface. Refer to such physics interface variables in expressions using the pattern `<name>.<variable_name>`. In order to distinguish between variables belonging to different physics interfaces, the `name` string must be unique. Only letters, numbers, and underscores (`_`) are permitted in the **Name** field. The first character must be a letter.

The default **Name** (for the first physics interface in the model) is `cd`.

DOMAIN SELECTION



Domains that do not conduct current should be omitted from the Domain Selection: for example, the gas channels in a fuel cell.

OUT-OF-PLANE THICKNESS



For 2D components, enter a value or expression for the out-of-plane **Thickness** d (SI unit: m). The value of d determines the size of the domain perpendicular to the modeled 2D cross section. This value yields, for example, the correct total current when the current density is obtained from a 2D simulation.

CROSS-SECTIONAL AREA



For 1D components, enter a **Cross-sectional area** A_c (SI unit: m^2) to define a parameter for the area of the geometry perpendicular to the 1D component. The value of this parameter is used, among other things, to automatically calculate the total current from the current density vector. The analogy is valid for other fluxes. The default is 1 m^2 .

CURRENT DISTRIBUTION TYPE

The **Current Distribution Type** selected in the list is based on the choice made when adding a physics interface — **Primary** or **Secondary**. The Primary Current Distribution interface changes to a Secondary Current Distribution interface if the choice is changed to **Secondary**, and vice versa.

The selection between **Primary** or **Secondary** governs how electrode reactions are modeled on interfaces between electrodes and electrolytes.

- Models using a **Primary** current distribution type use potential constraints (Dirichlet boundary conditions), according to the equilibrium potential setting.
- **Secondary** current distribution models use current flux conditions (Neumann boundary conditions) according to the sum of all electrode reaction current densities.

PHYSICS VS. MATERIALS REFERENCE ELECTRODE POTENTIAL

The **Physics vs. Materials Reference Electrode Potential** setting on the physics interface node can be used to combine material library data for current densities and equilibrium potentials with an arbitrary reference electrode scale in the physics. The setting affects the electrode potentials used for model input into the materials node, as well as all equilibrium potential values output from the materials node.

Note that the setting will only impact how potentials are interpreted in communication between the physics and the **Materials** node. If the **From material** option is not in use for equilibrium potentials or electrode kinetics, the setting has no impact.

DEPENDENT VARIABLES

This physics interface defines dependent variables (fields) for the **Electrolyte potential** and **Electric potential**. The names can be changed but the names of fields and dependent variables must be unique within a model.

DISCRETIZATION

The interface uses **Linear** elements by default and this setting is recommended for most problems. Certain types of problems, such as models using porous electrodes, or current distribution problems in two dimensions or higher, may benefit in terms of solution accuracy from using **Quadratic** elements.

In multiphysics models it is generally recommended to use the same element order in all coupled interfaces.

To see all settings in this section, click the **Show More Options** button () and select **Advanced Physics Options** in the **Show More Options** dialog box.



- [Electrochemical Reactions and the Difference Between a Primary and a Secondary Current Distribution](#)
- [Domain Equations for Primary and Secondary Current Distributions](#)
- [Shared Physics Features in the Current Distribution Interfaces](#)
- [Theory for the Current Distribution Interfaces](#)



Secondary Current Distribution: *Orange Battery*: Application Library
path **Battery_Design_Module/Batteries_General/orange_battery**

Electrolyte

Use the **Electrolyte** node to define an electrolyte domain that only conducts current in the ion conducting phase.

Note that electrolyte in this case does not refer to the pore electrolyte in porous electrodes (which should be defined by a [Porous Electrode](#) node instead).

The **Electrolyte conductivity**, σ_l (SI unit: S/m), parameter will define how the current in the domain depends on the gradient of the potential.



- [Domain Equations for Primary and Secondary Current Distributions](#)
 - [Electrolyte Theory](#)
-

Initial Values

Use this node to specify the **Initial Values** of the electrolyte potential and the electric potential for the solver.

For many electrochemical problems that use nonlinear electrode kinetics, such as Butler–Volmer kinetics, providing reasonable initial values can significantly improve solver convergence.

A good value for the **Electric potential** (SI unit: V) in electrode and porous electrode domains can usually be derived from the boundary conditions. For instance, if a boundary has been grounded or set to a cell potential, use that value as the initial value also in the adjacent domain. For the **Electrolyte potential** (SI unit: V) a good initial value is often the negative of the equilibrium potential of the grounded electrode.

Note: For **Primary** current distributions, or for models solved using a **Current Distribution Initialization** study step set to **Primary**, the settings of this section usually have limited impact on the solver convergence.

Porous Electrode

The **Porous Electrode** node sets up charge balances for the electrode and the pore electrolyte in a porous electrode. Note that the node should be used for porous domains that conduct current in both an electrolyte and an electrode phase. For the case of domains that do not contain a pore electrolyte — for instance, a current collector/feeder or a gas diffusion layer (GDL) in a fuel cell — use an [Electrode](#) node instead.

Use [Porous Electrode Reaction](#) subnodes to define the charge transfer reactions that occur on the interface between the electrolyte and electrode phases within the porous electrode. For the Secondary Current Distribution interface, the [Porous Matrix Double-Layer Capacitance](#) subnode is also available.

The conductivities are taken **From material** by default. From the respective material list you may any material in the model, if present. By default they are set to the **Domain material** (which is the material applied to the active domain in the **Materials** node).

You may use the **Effective conductivity correction** factors to account for the lowered effective conductivities of the electrode and electrolyte phases due to the lower volume fractions of each phase, and the tortuosity of the porous matrix.

The **Electrode volume fraction** is used to calculate the effective electrical conductivity of the porous matrix when the correction factor is set to **Bruggeman** or **Tortuosity**. Additionally, it is used in calculating the active specific surface area of the porous matrix when **Particle-based area** option is selected in the child nodes.

DISSOLVING-DEPOSITING SPECIES

Use the settings of this section to define species that participate in dissolution-deposition electrode reactions within the porous electrode, for instance metal deposition/dissolution or oxide formation.

Use the **Add** (+) and **Delete** (≡) buttons as needed in the tables to control the number of species.

Dependent variables for the volumetric molar concentration are added for each dissolving-depositing species. These variables can be used to keep track of the amount of reacted material in the porous electrode. The total molar dissolution/deposition rate depends on the reaction rates and stoichiometry, defined in the **Porous Electrode Reaction** subnodes.

The **Density** and **Molar mass** determine the electrode growth velocity and the resulting dissolved/deposited layer thickness. By multiplying by the electrode surface area (in the case of multiple electrode reaction the average surface area is used), the change in electrode and electrolyte volume fractions can be also be calculated. By use of the **Add volume change to electrode volume fraction** (not available for Separator node of Tertiary Current Distribution interface) and **Subtract volume change from electrolyte volume fraction** check boxes you may define how these volume changes should be included in the model.

Thickness variables, based on the surface area, are also defined that you for instance can use to couple to the Film Resistance (see below).

FILM RESISTANCE

See the [Electrode Surface](#) node.



- [Domain Equations for Primary and Secondary Current Distributions](#)
- [Porous Electrode Theory](#)



Capacity Fade of a Lithium-Ion Battery: Application Library path
Battery_Design_Module/Batteries,_Lithium-Ion/capacity_fade

Periodic Condition

Use the **Periodic Condition** to define a periodic relation between two boundaries — for instance, in a model describing a repetitive unit cell.

Use the **Apply for electrolyte phase** and **Apply for electrolyte** check boxes to enable the periodic condition for the electrolyte and electrode phase potentials, respectively.

By specifying a **Potential difference**, an offset in potential (typically per unit cell) can be prescribed.

For more information, see [Periodic Boundary Conditions](#) in the *COMSOL Multiphysics Reference Manual*.

Thin Electrolyte Layer

The Thin Electrolyte Layer node can be used to model a thin insulating or resistive sheet, located on an interior boundary in an electrolyte domain. The node can be used as an alternative to drawing the actual layer domain in the model geometry, which may significantly reduce meshing and solver time, especially in 3D models.

Thin insulating sheets are commonly inserted in the electrolyte in various types of electrochemical cells. For example they may be used for optimizing the current distribution in a corrosion protection application, or for optimizing the local deposition rate in a deposition bath.

The layer may be set to be either **Insulating** or **Resistive**.

For the case of **Resistive**, the **Surface Resistance** can either be set directly, or calculated from **Thickness and Conductivity** values.

ADVANCED SETTINGS

Enable **Slit electric potential in porous electrodes** to make the layer fully insulating for the electrode phase potential along the selected boundaries.

Edge Electrode

The **Edge Electrode** can be used in 3D problems to define electrodes such as long pipes and thin wires where the electric potential variation within the electrode in the normal direction to the electrode surface is negligible. This assumption allows for the thin electrode domain to be replaced by a lumped one-dimensional partial differential equation formulation on the edge, describing an electrode surface along the edge with a given **Edge electrode radius**. In this way the problem size can be reduced, and potential problems with mesh anisotropy in the thin layer can be avoided.

The electric current conduction in the tangential direction of an edge can be described by **Ohm's law** or a **Fixed** electric potential or a **Floating potential** assuming infinite conductivity of the edge or an **External short** electric potential which allows to connect two electrodes over an external connector with a given bulk resistance or a **Connection point** electric potential which allows to define a location for connections to other locations in the model.

An Edge Electrode can only be applied to edges within, or adjacent to, [Electrolyte](#) domains.

A default [Electrode Reaction](#) subnode is added by default to the feature. **Double Layer Capacitance**, **Electric Ground**, **Electric Potential**, and **Electrode Current** subnodes can also be added to the feature.

FILM RESISTANCE

See the [Electrode Surface](#) node. The section is only available when a **Secondary** current distribution has been selected on the parent node.

CONSTRAINT SETTINGS

To display this section, click the **Show More Options** button () and select **Advanced Physics Options** in the **Show More Options** dialog box.



The mesh size in the perpendicular direction to the edge should preferably be in the same order of magnitude as the **Edge electrode diameter** in order to achieve good numerical accuracy.

Electrode Line Current Source



For 3D components, use the **Electrode Line Current Source** on edges.



For 2D components use it on points.



For 2D axisymmetric components, it can only be selected on points outside the symmetry axis.

ELECTRODE CURRENT SOURCE

Enter the **Electrode current source** $q_{1,s}$ (SI unit: A/m). The default is 0 A/m.

Electrolyte Line Current Source



For 3D components, use the **Electrolyte Line Current Source** on edges.



For 2D components use it on points.



For 2D axisymmetric components, it can only be selected on points outside the symmetry axis.

ELECTROLYTE CURRENT SOURCE

Enter the **Electrolyte current source** $q_{1,l}$ (SI unit: A/m). The default is 0 A/m.

Electrode Symmetry Axis Current Source



For 2D axisymmetric components apply an **Electrode Symmetry Axis Current Source** along the symmetry axis boundary.

ELECTRODE CURRENT SOURCE

Enter the **Electrode current source** $q_{1,s}$ (SI unit: A/m). The default is 0 A/m.

Electrolyte Symmetry Axis Current Source



For 2D axisymmetric components apply an **Electrolyte Symmetry Axis Current Source** along the symmetry axis boundary.

ELECTROLYTE CURRENT SOURCE

Enter the **Electrolyte current source** $q_{1,l}$ (SI unit: A/m). The default is 0 A/m.

Electrode Point Current Source



For 3D components, use the **Electrode Points Current Source** on edges.

For 2D axisymmetric components, it can only be selected on points located on the symmetry axis.

ELECTRODE CURRENT SOURCE

Enter the **Electrode current source** $q_{p,s}$ (SI unit: A). The default is 0 A.

Electrolyte Point Current Source



For 3D components, use the **Electrolyte Points Current Source** on edges.

For 2D axisymmetric components, it can only be selected on points located on the symmetry axis.

ELECTROLYTE CURRENT SOURCE

Enter the **Electrolyte current source** $q_{p,l}$ (SI unit: A). The default is 0 A.

Electrode Current

Use this node to define a current source in a point of an Edge Electrode node.

This node is available as a subnode to the **Edge Electrode** node, when **Ohm's Law** has been selected as the electric potential model.

The Tertiary Current Distribution, Nernst-Planck Interface

In this section:



- [The Tertiary Current Distribution, Nernst-Planck Interface](#)
- [Electrolyte](#)
- [Porous Electrode](#)
- [Separator](#)
- [Reactions](#)
- [Thin Electrolyte Layer](#)
- [Initial Values](#)

Various nodes are also available and described for the Transport of Diluted Species interface. See [Domain, Boundary, and Pair Nodes for the Transport of Diluted Species Interface](#)



All other nodes in the Tertiary Current Distribution, Nernst-Planck interface are described in [Shared Physics Features in the Current Distribution Interfaces](#)

The Tertiary Current Distribution, Nernst-Planck Interface

The **Tertiary Current Distribution, Nernst-Planck (tcd)** interface () , found under the **Electrochemistry** branch () when adding a physics interface, describes the current and potential distribution in an electrochemical cell taking into account the individual transport of charged species (ions) and uncharged species in the electrolyte due to diffusion, migration, and convection using the Nernst-Planck equations. The physics interface supports different descriptions of the coupled charge and mass transport in the electrolyte (see [Electrolyte Charge Conservation](#) below). The electrode kinetics for the charge transfer reactions can be described by using arbitrary expressions or by using the predefined Butler-Volmer and Tafel expressions.

Ohm's law is used in combination with a charge balance to describe the flow of currents in the electrodes. The charge transfer reactions can be defined as boundary

conditions or as sources or sinks within a domain in order for the case of porous electrodes.



SETTINGS

The **Label** is the physics interface node name that will be shown in the model builder tree.

The **Name** is used primarily as a scope prefix for variables defined by the physics interface. Refer to such physics interface variables in expressions using the pattern `<name>.<variable_name>`. In order to distinguish between variables belonging to different physics interfaces, the `name` string must be unique. Only letters, numbers, and underscores (`_`) are permitted in the **Name** field. The first character must be a letter.

The default **Name** (for the first physics interface in the model) is `tcd`.

DOMAIN SELECTION

The domains that do not conduct current should be omitted from the selection list, for example, the gas channels in a fuel cell.

OUT-OF-PLANE THICKNESS

For 2D components, the **Thickness** field (default value: 1 m) defines a parameter for the thickness of the geometry perpendicular to the two-dimensional cross-section. The value of this parameter is used, among other things, to automatically calculate the total current from the current density vector. The analogy is valid for other fluxes.

CROSS-SECTIONAL AREA

For 1D components, enter a **Cross-sectional area** A_c (SI unit: m^2) to define a parameter for the area of the geometry perpendicular to the 1D component. The value of this parameter is used, among other things, to automatically calculate the total current from the current density vector. The analogy is valid for other fluxes. The default is 1 m^2 .

ELECTROLYTE CHARGE CONSERVATION

The physics interface features five different descriptions of the coupled charge and mass transport in the electrolyte.

Use the **Electroneutrality** or the **Electroneutrality, water based** charge conservation option to model cells with significant concentration gradients of the current-carrying species (ions). The electroneutrality condition implicitly assumes that all major current-carrying ions are included in the model. In addition to the electroneutrality condition, the **Electroneutrality, water based** option also adds the water auto-ionization equilibrium condition, including proton and hydroxide transport, when defining the electrolyte equations. Note that this option adds the concentration variables for protons (`tc.d.ch`) and hydroxide (`tc.d.OH`) automatically, and that dependent variables for these two species should not be added under **Dependent Variables** below. With this setting, to control the initial pH in a simulation, set the initial concentrations of the other ions in the simulation such that the matching concentration of protons and hydroxide ions matches the pH desired. For pH less than 7, add and set the concentration of anions. For pH more than 7, add and set the concentration of cations. For example, for a water-based system with only Cl⁻, an initial concentration for Cl⁻ of 10⁻⁵ M will result in an initial pH of 5. This is analogous to acidifying the solution using HCl.

A **Supporting electrolyte** describes a situation where the major part of the charge is transferred by ions whose concentration can be described as constant.

Use the **Electroanalysis** (no potential gradients) option to model electroanalytical problems with electrolyte solutions containing a large quantity of inert supporting electrolyte, with a conductivity so high that ohmic losses can be assumed to be negligible. The electroanalysis option will not solve for the electrolyte potential as a dependent variable, setting it to a constant value of 0. Migration effects are hence neglected. Domain and boundary nodes only applicable to the electrolyte phase potential will be disabled when using electroanalysis.

The **Poisson** option couples the Nernst–Planck equations for mass transport to the Poisson equation for describing the potential distribution in the electrolyte, without any assumption of electroneutrality. This option is typically used when modeling problems where charge separation effects are of interest, typically within nanometers from an electrode surface.

For the Electroneutrality option, the **From electroneutrality** list sets the species that is calculated from the corresponding condition. Note that the choice of species to be taken from electroneutrality affects the specific boundary conditions that can be set on the eliminated species. For example, flux and concentration settings cannot be set for the eliminated species, and initial values cannot be provided. The choice can also have an impact on the numerics of the problem.

A general advice is to choose a relatively inert ion with high mole fraction to be taken from electroneutrality for best numerical results.

PHYSICS VS. MATERIALS REFERENCE ELECTRODE POTENTIAL

The **Physics vs. Materials Reference Electrode Potential** setting on the physics interface node can be used to combine material library data for current densities and equilibrium potentials with an arbitrary reference electrode scale in the physics. The setting affects the electrode potentials used for model input into the materials node, as well as all equilibrium potential values output from the materials node.

Note that the setting will only impact how potentials are interpreted in communication between the physics and the **Materials** node. If the **From material** option is not in use for equilibrium potentials or electrode kinetics, the setting has no impact.

DEPENDENT VARIABLES

This physics interface defines these dependent variables (fields), the **Concentrations** of the species, the **Electrolyte potential**, and the **Electric potential**.

The names can be changed but the names of fields and dependent variables must be unique within a model.

DISCRETIZATION

Concentrations basis function orders higher than **Quadratic** are not recommended if transport by convection is dominating in the model.

To see all settings in this section, click the **Show More Options** button () and select **Advanced Physics Options** from the **Show More Options** dialog box.

CONSISTENT STABILIZATION AND INCONSISTENT STABILIZATION

To display these sections, click the **Show More Options** button () and select **Stabilization** from the **Show More Options** dialog box. There are two consistent stabilization methods available and selected by default — **Streamline diffusion** and **Crosswind diffusion**. There is one inconsistent stabilization method, **Isotropic diffusion**,

which is not selected by default. Any settings unique to this physics interface are listed below.

- When the **Crosswind diffusion** check box is selected, a weak term that reduces spurious oscillations is added to the transport equation. The resulting system is nonlinear. There are two options for **Crosswind diffusion type**:
 - **Do Carmo and Galeão** — the default option. This type of crosswind diffusion reduces undershoot and overshoot to a minimum but can in rare cases give equations systems that are difficult to fully converge.
 - **Codina**. This option is less diffusive compared to the Do Carmo and Galeão option but can result in more undershoot and overshoot. It is also less effective for anisotropic meshes. The Codina option activates a text field for the **Lower gradient limit** g_{lim} (SI unit: mol/m⁴). It defaults to $0.1 [mol/m^3] / tds.helem$, where $tds.helem$ is the local element size.
- For both consistent stabilization methods, select an **Equation residual**. **Approximate residual** is the default setting and it means that derivatives of the diffusion tensor components are neglected. This setting is usually accurate enough and is faster to compute. If required, select **Full residual** instead.



In the *COMSOL Multiphysics Reference Manual* see [Table 2-4](#) for links to common sections and [Table 2-5](#) to common feature nodes. You can also search for information: press F1 to open the **Help** window or Ctrl+F1 to open the **Documentation** window.



- [The Nernst–Planck Equations](#)
- [Domain Equations for Tertiary Current Distributions Using the Nernst–Planck Equations and Electroneutrality](#)
- [Shared Physics Features in the Current Distribution Interfaces](#)
- [Theory for the Current Distribution Interfaces](#)



Vanadium Redox Flow Battery: Application Library path
Battery_Design_Module/Flow_Batteries/v_flow_battery

Electrolyte

Use the **Electrolyte** node to define an electrolyte domain that only conducts current in the ion conducting phase. The combined charge and mass transfer in the electrolyte is defined by the node.

What settings are available in this node depends on the [Electrolyte Charge Conservation](#) setting, available on the top node. The **Electrolyte conductivity** (SI unit: S/n) setting is only available for the **Supporting Electrolyte** option. Diffusivity and mobility settings for H^+ and OH^- are only available for the **Electroneutrality, water-based** option.

The **Convection** section is available when the **Convection** check box is selected on the interface top node. The **Velocity field \mathbf{u}** (SI unit: m/s) of the solvent is specified as a feature input. Select the source of velocity field from the velocity field list.

By default the **Mobility** (SI unit: s·mol/kg) for each species is set to be calculated based on the diffusion coefficients (SI unit: m^2/s) specified in the **Diffusion** section and the temperature using the **Nernst-Einstein relation**.

The mobility setting will only have an impact on the transport by migration of charged species, as defined by the **Charge number z_c** (dimensionless, specify negative charges using a minus sign). For the **Electroneutrality** charge conservation model you need at least one positively and one negatively charged species (ion) in the electrolyte.

Specify the temperature (if you are using mobilities based on the **Nernst-Einstein relation**) in the **Model Inputs** section.

The **Water Self-ionization** section is available for the **Electroneutrality, water-based** option. The section allows the water self-ionization constant to be set. Using the **Built in** option, the constant will be set to account for temperature, giving the pH of the simulation the correct temperature dependence.

Note that the electrolyte in this case does not refer to the pore electrolyte in porous electrodes (which should be defined by a [Porous Electrode](#) node instead). For porous separators, use the [Separator](#) instead.



- [Electrolyte Theory](#)
 - [Domain Equations for Tertiary Current Distributions Using the Nernst–Planck Equations and Electroneutrality](#)
-

Porous Electrode

The **Porous Electrode** node sets up charge balances for the electrode and the pore electrolyte in a porous electrode, and as well as the mass balance for the species in the electrolyte.

Note that the node should be used for porous domains that conduct current in both an electrolyte and an electrode phase. For the case of domains that do not contain a pore electrolyte — for instance, the gas diffusion layer (GDL) in a PEMFC electrode — use an **Electrode** node instead.

Use Porous Electrode Reaction child nodes to define the charge transfer reactions that occur on the interface between the electrolyte and electrode phases within the porous electrode. The Porous Matrix Double Layer Capacitance subnode is also available.

See the [Electrolyte](#) node for more information about the **Diffusion** and **Migration in Electric Field** settings of this node.

Correction factors may be specified in the **Effective Transport Parameter Correction** section to account for the lowered effective conductivities of the electrode and electrolyte phases due to the lower volume fractions of each phase, and the tortuosity of the porous matrix.

The **Electrode volume fraction** is used to calculate the effective electrical conductivity of the porous matrix when the correction factor is set to **Bruggeman** or **Tortuosity**. Additionally, it is used in calculating the active specific surface area of the porous matrix when **Particle-based area** option is selected in the child nodes.

DISSOLVING-DEPOSITING SPECIES

See the **Porous Electrode** node of [The Primary and Secondary Current Distribution Interfaces](#)

FILM RESISTANCE

See the [Electrode Surface](#) node.



- [Porous Electrode Theory](#)
 - [Porous Electrode Reactions Theory](#)
 - [Domain Equations for Tertiary Current Distributions Using the Nernst–Planck Equations and Electroneutrality](#)
-

Separator

Use a **Separator** node to model electrolyte charge and mass transport in an electronically isolating porous matrix. Use correction factors to account for the lowered diffusion coefficients in the electrolyte and the lowered conductivities of the electrode, due to the lower volume fractions of each phase and the tortuosity of the porous matrix.

See also the [Electrolyte](#) node for more information about the **Diffusion and Migration in Electric Field** settings of this node.

DISSOLVING-DEPOSITING SPECIES

See the **Porous Electrode** node of [The Primary and Secondary Current Distribution Interfaces](#)

Reactions

Use the **Reactions** node to define nonelectrochemical reactions in an electrolyte domain.

The node is found from the **Additional Sources** submenu.

REACTING VOLUME

When specifying reaction rates in the R_{e2} (SI unit: mol/m³·s) fields for a species in a [Porous Electrode](#) domain, the specified reaction rate expression may either refer to the total volume or the pore (electrolyte) volume. For nonporous domains the settings of the Reacting Volume section has no impact.

For **Total volume** the reaction expressions are used as specified (multiplied by unity).

For **Pore volume** this results in the specified reaction expressions being multiplied by the domain electrolyte volume fraction ε_l . (ε_l equals unity for nonporous domains).

Initial Values

Use this node to specify the **Initial Values** of the concentration, electrolyte potential and electric potential dependent variables to be used by the solver.

For many electrochemical problems that use nonlinear electrode kinetics, such as Butler–Volmer kinetics, providing reasonable initial values can significantly improve solver convergence.

A good value for the **Electric potential** (SI unit: V) in electrode and porous electrode domains can usually be derived from the boundary conditions. For instance, if a boundary has been grounded or set to a cell potential, use that value as the initial value also in the adjacent domain. For the **Electrolyte potential** (SI unit: V) a good initial value is often the negative of the equilibrium potential of the grounded electrode.

For the **Concentration** initial values, at least one positive and one negative charged species should have a nonzero and positive initial value (after considering the electroneutrality condition). The initial value for the ion calculated from the electroneutrality condition cannot be set explicitly.

Ion Exchange Membrane

Use the ion exchange membrane node to specify a domain with a permanent fixed space charge. The node is typically used for defining permselective membranes, used for various applications such as dialysis cells or flow batteries.

The node models the transport of all species added at the interface top node, and adds a fixed space charge to the electroneutrality condition.

The **Fixed space charge** specifies the charge ions fixed in the membrane polymer matrix. Use negative space charges for cation selective membranes and positive charges for anion selective membranes, respectively.

Select the **Apply Donnan Boundary Conditions** check box to enable Donnan equilibrium conditions on all interior boundaries between the domain selected by the node and all adjacent domains selected by the interface (except **Electrode** nodes). The boundary conditions are applied for all species and the electrolyte potential dependent variable. This option is not available for the **Poisson** charge conservation model option.

For the remaining settings of this node, see the [Electrolyte](#) and [Separator](#) nodes.

Ion Exchange Membrane Boundary

Use the Ion Exchange Membrane boundary node to specify an external boundary over which the flux of a charge-carrying species is continuous but the electrolyte potential shifts with a specified value. This condition is typically used in electrochemical cells containing both free electrolytes and ion exchange membranes, for instance in dialysis or flow battery problems. The node is typically used to couple two separate current distribution interfaces, where one of the interfaces models free electrolyte domain, and the other interface models the ion-exchange membrane domain.

Note that using the [Ion Exchange Membrane](#) domain node often is a more convenient modeling approach if the transported species in the free electrolyte and ion exchange membrane are the same.

The node is applicable to external boundaries to electrolyte domains. For defining ion-exchange membranes on an interior boundary between two electrolyte domains, use the [Thin Electrolyte Layer](#) node.

The choice of **Charge-carrying species concentration species** specifies that the current flowing over the boundary will be carried by this species (which must have a nonzero charge number). Use the **Membrane potential** setting to set the electrolyte potential on the membrane side of the boundary. Note that if this potential is set to the electrolyte potential of a Primary or Secondary Current Distribution interface, no additional settings are needed in that interface to set up the correct boundary condition.

The potential condition may be either **Donnan**, which will calculate the potential shift over the boundary based on the membrane charge carrying species concentration, or can be **User defined**.

Thin Electrolyte Layer

Use this node to specify a thin layer on an interior boundary between two electrolyte domains. The node can be used as an alternative to drawing the actual layer as a domain in the model geometry, which may significantly reduce meshing and solver time, especially in 3D models.

The layer may either be **Insulating, Resistive** (supporting electrolytes only), or an **ion exchange membrane**.

For **Resistive** or **ion exchange membrane**, the potential drop over the membrane is determined either from the **Surface resistivity** or the **Thickness and conductivity**.

For **ion exchange membrane**, the choice of **Charge-carrying species concentration species** specifies that the current flowing over the layer will be carried by this species (which must have a nonzero charge number). The potential condition may be either **Donnan**, which calculates the potential shift over the boundary based on the membrane charge carrying species concentration, or **User defined**.

Shared Physics Features in the Current Distribution Interfaces

Domain, Boundary, Pair, Edge, and Point Nodes for the Electrochemistry Interfaces

This chapter describes various domain, boundary, edge, point, and pair nodes that are common to several of the [Electrochemistry Interfaces](#) interfaces.

The nodes are available from the **Physics** ribbon toolbar (Windows users), **Physics** context menu (macOS or Linux users), or right-click to access the context menu (all users). The nodes and features described in this section are available for all the Electrochemistry branch interfaces unless otherwise indicated.



In general, to add a node, go to the **Physics** toolbar, no matter what operating system you are using. Subnodes are available by (right) clicking the parent node and selecting it from the **Attributes** menu.

- Charge-Discharge Cycling
- Circuit Terminal
- Double-Layer Capacitance
- Electric Ground
- Electric Potential
- Electric Reference Potential
- Current Conductor
- Electrode Current
- Electrode Current Density
- Electrode Current Source
- Electrode-Electrolyte Boundary Interface
- Electrode Power
- Electrode Potential
- Electrode Reaction
- Electrode Surface
- Electrolyte Current Density
- Electrolyte Current Source
- Electrolyte Potential
- External Short
- Harmonic Perturbation
- Highly Conductive Porous Electrode
- Initial Values for Adsorbing-Desorbing Species
- Initial Values for Dissolving-Depositing Species
- Insulation
- Perforated Electrode Surface
- Internal Electrode Surface
- Line Mass Source¹
- Nonfaradaic Reactions
- Point Mass Source¹
- Porous Electrode Reaction
- Porous Matrix Double-Layer Capacitance
- Reference Electrode
- Symmetry
- Thin Electrode Layer

¹ For the Tertiary Current Distribution, Nernst–Planck interface, these nodes are available and described for the Transport of Diluted Species interface.



In the *COMSOL Multiphysics Reference Manual* see [Table 2-4](#) for links to common sections and [Table 2-5](#) to common feature nodes. You can also search for information: press F1 to open the **Help** window or Ctrl+F1 to open the **Documentation** window.



Theory for the Current Distribution Interfaces

Current Conductor

Use the **Current Conductor** node to define an electrode domain that only conducts current in the electron conducting phase.

The node is typically used for modeling solid metal electrodes, current collectors, current feeders, gas diffusion layers and gas backings.

The **Electrical conductivity** σ_s (SI unit: S/m) parameter will define how the current in the domain depends on the gradient of the potential.



Electrode Theory

Highly Conductive Porous Electrode

The **Highly Conductive Porous Electrode** node defines a charge balance of the pore electrolyte in a porous electrode, and, for interfaces solving for electrolyte species, the corresponding mass balance for the species in the electrolyte. Use this node when electrical conductivity is high enough to assume uniform potential in the electron conducting phase of the porous electrode.

See the [Electrode Surface](#) node for a description of the Electrode Phase Potential Condition and Harmonic Perturbation sections.

See the [Porous Electrode](#) node for a description of the remaining settings.

Electrode Current Source

Use the **Electrode Current Source** node to define contributions to the current density from electron current sources. The **Current source**, Q_s (SI unit: A/m³), is added according to the following equation:

$$\nabla \cdot \mathbf{i}_s = Q_s$$

where

$$\mathbf{i}_s = -\sigma_s \nabla \phi_s$$

and σ_s denotes the electrode's conductivity and ϕ_s the electric potential.

To use this feature, click the **Show More Options** button () and select **Advanced Physics Options** in the **Show More Options** dialog box. Then add the node from the **Additional Sources** submenu.

Electrolyte Current Source

Use the **Electrolyte Current Source** node to define contributions to the current density in the electrolyte from, for example reactions, or other effects.

The **Current source**, Q_1 (SI unit: A/m³), is added according to the following equation:

$$\nabla \cdot \mathbf{i}_l = Q_l$$

To use this feature, click the **Show More Options** button () and select **Advanced Physics Options** in the **Show More Options** dialog box. Then add the node from the **Additional Sources** submenu.

Porous Electrode Reaction

The **Porous Electrode Reaction** node defines the electrode kinetics for a charge transfer reaction that occurs at the interface between the pore electrolyte and the electrode matrix a porous electrode. The node can be added as subnode to a **Porous Electrode** node. Add multiple nodes to the same **Porous Electrode** node to model multiple reactions, for instance in mixed potential problems.

See the [Electrode Reaction](#) node for a description of the Equilibrium Potential, Electrode Kinetics, Stoichiometric Coefficients and Heat of Reaction sections.

ACTIVE SPECIFIC SURFACE AREA

The **Active specific surface area**, a_v (SI unit: m²/m³) specifies the area of the electrode-electrolyte interface that is catalytically active for this porous electrode reaction. a_v is multiplied by i_{loc} , defined in the Electrode Kinetics section, to produce a current source in the domain.

This section is not available for primary current distribution interfaces.



- [Porous Electrode Reactions Theory](#)
 - [Electrode Kinetics Expressions.](#)
-

Porous Matrix Double-Layer Capacitance

Use the **Porous Matrix Double-Layer Capacitance** subnode to define a nonfaradaic double-layer current density at the interface between the porous electrode matrix and the electrolyte. The node can be added as subnode to a **Porous Electrode** node.

The resulting double-layer current source in the **Porous Electrode** domain depends on the time derivative of the potentials and is proportional to both the **Electrical double-layer capacitance** C_{dl} (SI unit: F/m²) and the **Double-layer area** $a_{v,dl}$ (SI unit: 1/m).

Note that for stationary problems the double-layer current is zero.

This node is not available for the Primary Current Distribution interface.

Use the settings of the **Stoichiometry** section (not available in the Primary or Secondary Current Distribution interfaces) to control what species are participating in the double-layer charging — that is, the mass exchange between the double layer and the electrolyte outside the double layer.

Insulation

The **Insulation** boundary condition describes the walls of a cell or the boundaries of the cell that do not face a conductor. The boundary condition imposes the following equation:

$$\mathbf{i}_k \cdot \mathbf{n} = 0$$

where \mathbf{i}_k denotes the current density vector and $k = l, s$ is an index for the electrolyte and electrode, respectively.

Symmetry

For the Primary Current Distribution and Secondary Current Distribution interfaces, the **Symmetry** boundary condition is identical to the **Insulation** condition.

For the Tertiary Current Distribution, Nernst–Planck interface, the **Symmetry** boundary condition imposes a no flux condition for the molar flux of species at a boundary.



Symmetry Theory

Electrode Surface

Use the **Electrode Surface** node to model an electrochemical electrode-electrolyte interface between an electrolyte domain and an electrode boundary where the electrode is not included explicitly as a domain in the model geometry. Set the electric potential of the electrode or specify a current condition that the potential of the electrode shall fulfill, and use subnodes to specify the [Electrode Reaction](#) and the [Double-Layer Capacitance](#) at the interface.

This node can only be applied on outer boundaries to electrolyte domains. For interior boundaries between electrolyte and electrode domains, use the [Internal Electrode Surface](#) node. For interior boundaries to electrolyte domains, use the [Perforated Electrode Surface](#) node.

DISSOLVING-DEPOSITING SPECIES

Use the settings of this section to define species that participate in dissolution-deposition electrode reactions, for instance metal deposition/dissolution or oxide formation.

Use the **Add** (+) and **Delete** (≡) buttons as needed in the table to control the number of species.

The **Density** and **Molar mass**, in conjunction with the reaction rates and stoichiometry, defined in the **Electrode Reaction** subnodes, determine the normal electrode growth rate.

When the **Solve for species concentrations variables** check box is checked, dependent variables for the molar surface concentration of the dissolving-depositing species are added. These can be used to model the thickness of a dissolving/depositing layer in a time-dependent simulation where the resulting deformation in the model geometry is small and will have negligible impact on the current distribution. In stationary studies, the molar surface concentration variables will be defined but not solved for by default.

When solving for the species concentration variables, corresponding thickness variables are defined that you for instance can use to couple to the Film Resistance (see below).



Deposition-Dissolution Rates, Growth Velocities, and Thicknesses on an Electrode Surface

ADSORBING-DESORBING SPECIES

Use the settings of this section to define species that may adsorb or desorb on the electrode surface during charge transfer, or nonfaradaic, reactions.

The **Density of sites parameter** will be used to set up the local surface mass balance equations for the fractional surface coverages.

Use the **Add** (+) and **Delete** () buttons as needed in the table to control the number of species. The name of each adsorbing-desorbing **Species** may be edited in the first column of the table. Use a **Site occupancy number** larger than unity for species that occupy more than one site at the electrode surface.

According to the settings of the table, the fractional surface coverage variable names will be defined according to $xxx.\theta_{yyy_zzz}$ where xxx is the interface name, yyy the tag of the electrode surface node, and zzz the species name. The variable $xxx.\theta_{free_yyy}$ represents the fraction of free surface sites. These variable names may be used when defining kinetics parameters in [Electrode Reaction](#) subnodes.



Use [The Surface Reactions Interface](#) to model surface diffusion.

FILM RESISTANCE

Use a film resistance if you want to include an additional potential drop due to an ohmic resistance at the interface between the electrode and the electrolyte, for instance due to build-up of insulating deposits.

Specify either a **Surface resistance** R_{film} (SI unit: $\Omega \cdot \text{m}^2$) directly or choose the **Thickness and conductivity** option to calculate the surface resistivity based on a depositing film thickness.

HARMONIC PERTURBATION

Use this section in conjunction with AC Impedance study types to control the perturbation amplitude in the frequency domain.

The perturbation parameter is either **Electric potential**, **Electrode potential**, **Total current**, or **Average current density**, based on the **Boundary condition** selected in the next section.

The frequency spectrum is specified in the study node.

ELECTRODE PHASE POTENTIAL CONDITION

This section specifies the potential in the electrode phase of the electrolyte-electrode interface. The electrode potential is used (via the overpotential) by the **Electrode Reaction** subnodes.

Use the **Electric potential** option to set the value of the potential explicitly with respect to ground whereas the **Electrode potential** will set the potential value with respect to a reference potential. **Total current**, **Average current density**, and **External short** all add an extra global degree of freedom for the potential in the electrode phase, set to comply with the chosen condition.

When using the **Total current** option in 1D or 2D, the boundary area is based either on the **Cross-sectional area** (1D), or the **Out-of-Plane thickness** (2D) properties, set on the physics interface top node.

See also the documentation for the [Electrode Potential](#) and [External Short](#) nodes for further information about these boundary condition.

Cyclic Voltammetry

The **Cyclic voltammetry** setting varies the electric potential linearly in time as follows when used in conjunction with a Cyclic Voltammetry study step:

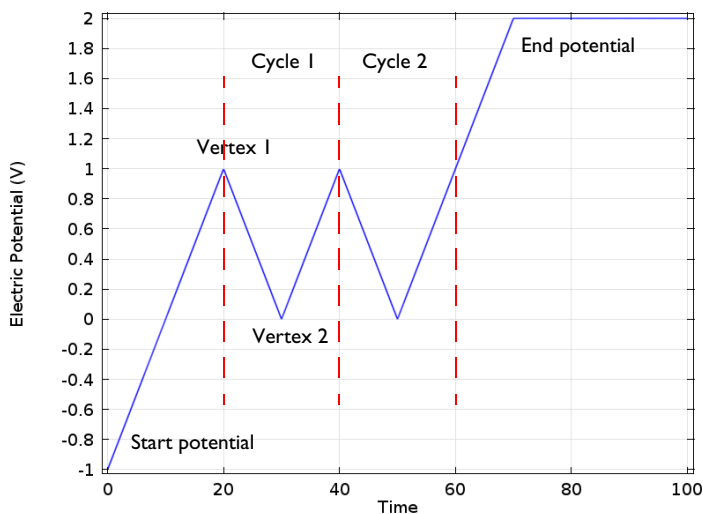

Figure 4-1: Electric potential vs time generated by the cyclic voltammogram boundary condition. The linear sweep rate is 100 mV/s, the number of cycles is 2. Potentials levels are also shown.

More advanced waveforms can be obtained using the **Electric potential** option with a parameter setting based on **Functions** found in the **Definitions** menu.

Counter Electrode (Electroanalysis Only)

This boundary condition is only available for the **Electroanalysis** charge conservation model in the **Tertiary Current Distribution, Nernst-Planck (tcd)** interface.

The **Counter electrode** option will set a potential to ensure an overall charge balance of the cell so that the integral of all electrode reaction currents of all electrode surface node sums up to zero.

See also [Counter Electrodes and Overall Charge Balance](#)

ADVANCED CYCLIC VOLTAMMETRY SETTINGS

To display this section, click the **Show More Options** button () and select **Advanced Physics Options** in the **Show More Options** dialog box.

If **Cyclic voltammetry** is selected as the **Boundary condition**, the check boxes **Add events at vertex potentials in cyclic voltammetry** and **Smoothing of cyclic voltammetry wave functions** are both selected by default.

When **Smoothing of cyclic voltammetry wave functions** is enabled, smoothing is applied on the triangular wave around the vertex potentials. The **Smoothing factor** defaults to $1 \cdot 10^{-3}$. The smoothing zone corresponds to the product of the smoothing factor with half the duration of one period of the triangular wave.

When **Add events at vertex potentials in cyclic voltammetry** is enabled, solver events are added at the vertex potentials for the cyclic voltammogram. When the vertex potentials are reached, these events cause the solver to stop, reinitialize some variables, and then continue. This typically improves solver convergence. In addition, by forcing the time-dependent solver to resolve the time steps when the vertex potentials are reached, the solution accuracy is improved, especially if the solver is set to output solutions before and after events.

EQUILIBRIUM POTENTIAL HANDLING (PRIMARY CONDITION)

This setting only has an effect if there are multiple Electrode Reaction subnodes present and if either a Current Distribution Initialization study step (using a Primary Current distribution type) or the Primary Current Distribution interface is used.

The setting determines which equilibrium potential value will be used for defining the primary current distribution constraint. When the **First reaction** has been selected, the first electrode reaction subnode must be active in the model.

To display this section, click the **Show More Options** button () and select **Advanced Physics Options** in the **Show More Options** dialog box.

CONSTRAINT SETTINGS

For primary current distributions, the use of weak constraints will in some cases give a more accurate value of the local current density during the solver process. This may in turn render more accurate results when coupling to the local current density variable to describe other phenomena in the model, for instance when modeling geometry deformation due to electrode dissolution/deposition.

The section is available in the Primary Current Distribution and Secondary Current Distribution interfaces when the **Current Distribution Model** property has been set to **Primary**.

This section is only available in the Primary Current Distribution and Secondary Current Distribution interfaces when the **Current Distribution Model** property has been

set to **Primary**. To display this section, click the **Show More Options** button () and select **Advanced Physics Options** in the **Show More Options** dialog box.

	<ul style="list-style-type: none">• Electrode Reactions Theory• Film Resistance
---	--

	For an example of this feature see <i>Orange Battery</i> : Application Library path Battery_Design_Module/Batteries,_General/orange_battery .
---	--

Electrode Reaction

The **Electrode Reaction** subnode defines the electrode kinetics for a charge transfer reaction that occurs on an electrolyte-electrode interface boundary. Use multiple nodes to model multiple reactions, for instance in mixed potential problems.

The parent node may be either an [Internal Electrode Surface](#) or an [Electrode Surface](#).

Note that all settings described below are not available for all Electrochemistry interfaces.

	<ul style="list-style-type: none">• Electrode Reactions Theory
---	--

EQUILIBRIUM POTENTIAL

The **Equilibrium potential**, E_{eq} (SI unit: V), is used in the electrode kinetics expressions in the Electrode Kinetics section (via the definition of the overpotential), or for setting up primary current distribution potential constraints.

The equilibrium potential may be defined either in the Materials node (**From material**), by using the **Nernst Equation**, or by using a **User defined** expression.

If the Nernst Equation is used, the concentration dependence is calculated automatically based on the **Reference equilibrium potential** $E_{\text{eq, ref}}$ (V).

For all interfaces except the Tertiary Current Distribution interface, the concentration dependence is based on the user-defined **Reduced species expression** C_R (unitless) and **Oxidized species expression** C_O (unitless) parameters. C_R and C_O should be defined so that the quotient between them is 1 for the reference state (for which $E_{\text{eq}}=E_{\text{eq, ref}}$).

In the Tertiary Current Distribution interface, the concentration dependence of the Nernst Equation is based entirely on the settings in the **Stoichiometric Coefficients** and the **Reference Concentrations** sections.

When using Nernst Equation, additional options are available in the **Butler-Volmer** expression type in the Electrode Kinetics section.



- [Equilibrium Potentials and the Nernst Equation](#)

REFERENCE CONCENTRATIONS

This section is only available in the Tertiary Current Distribution interface, if the equilibrium potential has been selected to be defined by the **Nernst Equation**.

The reference concentrations define the reference state for which $E_{\text{eq}} = E_{\text{eq, ref}}$.

ELECTRODE KINETICS

The settings of this section will define the local current density, i_{loc} (SI unit: A/m^2), at the interface between the electrolyte and the electrode. Note that i_{loc} for all built-in kinetics expression types will depend on the overpotential, which in turn depend on the Equilibrium potential defined in the previous section.

The **Local current density expression**, $i_{\text{loc, expr}}$ (SI unit: A/m^2), may be defined either in the Materials node (**From material**), by using the **From kinetics expression**, or by using a **User defined** expression.

For all kinetic expressions the **Exchange current density** i_0 (SI unit: A/m^2) is a measure of the kinetic activity. The exchange current density is typically concentration dependent.

Most kinetic expression types feature the **Limiting Current Density** option in order to impose an upper limit on the local current density magnitude. The feature can be used to model additional mass transport limitations that are not already included in the local current density expression. For **Limiting Current Density** enter a value for i_{lim} (SI unit: A/m^2).

In the Tertiary Current Distribution interface, the **Linearize concentration dependence for low concentrations** option is used to set a **Concentration linearization limit** c_{lim} (SI unit: mol/m^3) for linearizing the concentration dependence of kinetics for low concentrations, in order to improve convergence for nonunit stoichiometries. Note that this option is available for **Nernst Equation** equilibrium potential and **Butler-Volmer**

kinetics with either **Mass action law** or **Lumped multistep** selected as the exchange current density type.

Butler–Volmer or Linearized Butler–Volmer

The Butler–Volmer kinetics expression is the most common way to define electrochemical kinetics. The **Linearized Butler–Volmer** is valid when the overpotentials of the reactions are small ($\ll 25$ mV). The linearized version can also be used to troubleshoot a model with convergence problems.

When using the **Nernst Equation** for defining the equilibrium potential (see above), the concentration dependence of the **Exchange current density** i_0 may be defined in a thermodynamically consistent way in accordance with the Nernst equation, in combination with a **Reference exchange current density** $i_{0,\text{ref}}$ (A/m^2), which is the exchange current density when $E_{\text{eq}} = E_{\text{eq, ref}}$.

For all interfaces except the Tertiary Current Distribution interface, the concentration dependence when using **From Nernst Equation** will use C_R and C_O as preexponential factors for the anodic and cathodic terms, respectively. In the Tertiary Current Distribution interface, the **Lumped multistep** option can be used to define i_0 by the use of either **Generic** exponentials, or **Anodic** or **Cathodic** reaction orders. The **Mass action law** will define the reaction orders according to the reaction stoichiometry and the law of mass action.

The **Anodic transfer coefficient**, α_a (dimensionless), and **Cathodic transfer coefficient**, α_c (dimensionless), parameters will impact how much i_{loc} will change upon changes in the overpotential. In order to ensure thermodynamic consistency, α_c cannot be user defined when i_0 is calculated **From Nernst Equation** (or by **Mass action law** in the Tertiary Current Distribution interface). For this case, α_c is defined automatically, based on the number of participating electrons in the reaction, defined in the stoichiometry section.

Anodic Tafel Equation

This kinetics expression type neglects the cathodic (negative) term in the Butler–Volmer equation. It is only valid for electrode reactions with high anodic overpotentials ($\gg 100$ mV).

The **Anodic Tafel slope**, A_a (SI unit: V), defines the required increase in overpotential to result in a tenfold increase in the current density.

Cathodic Tafel Equation

This kinetics expression type neglects the anodic (positive) term in the Butler–Volmer equation. It is only valid for electrode reactions with significant cathodic overpotentials ($\ll -100$ mV).

The **Cathodic Tafel slope**, A_c (SI unit: V), describes the required decrease in overpotential to result in a tenfold increase in the current density magnitude. A_c should be a negative value.

Concentration Dependent Kinetics

This expression type is not available if **Nernst equation** has been selected in the Equilibrium Potential section.

Note that the combination of **Nernst equation** and the **Butler-Volmer** kinetics type will in most cases render identical kinetics as for the Concentration Dependent Kinetics. It is recommended to always use Nernst Equation + Butler-Volmer whenever possible, since this combination is guaranteed to be thermodynamically consistent.

The Concentration Dependent Kinetics expression type may be used in concentration dependent (tertiary) current distribution problems. One or both of the **Oxidizing species expression** C_O (dimensionless) and **Reducing species expression** C_R (dimensionless) parameters may be concentration dependent, and should typically be defined so that $C_O = C_R$ at equilibrium.



- [Electrode Kinetics Expressions](#)

Fast Irreversible Electrode Reaction

This kinetics expression type is typically used in tertiary current distribution problems for reactions occurring far away from the equilibrium potential.

The kinetics expression type defines an irreversible electrode reaction where the kinetics is so fast that the only factor limiting the reaction rate is the transport of a species to the reacting surface.

The node will set the **Rate limiting species concentration to zero** at the boundary, and balance the fluxes of the species participating in the reaction and the current densities according to the Stoichiometric Coefficients settings.

Thermodynamic Equilibrium (Primary Condition)

This choice imposes a zero overpotential for the electrode reaction by applying a constraint on the potential variables in order to comply with the equilibrium potential. Use this kinetics for very fast reactions.

In the Secondary Current Distribution interface the condition set by this expression type is mathematically identical to what is applied when a Primary Current

Distribution is chosen on the interface top node. The expression type can hence be used to mix primary and secondary current distributions on different electrodes. The Thermodynamic equilibrium (primary condition) cannot not be used when defining the kinetics for multiple electrode reactions at the same electrode in the Secondary Current Distribution interface.

STOICHIOMETRIC COEFFICIENTS

Specify the **Number of participating electrons** n_m in the electrode reaction and the **Stoichiometric coefficient** (v_{c1} , v_{c2} , and so forth) for each of the involved species according to the following generic electrochemical reaction:

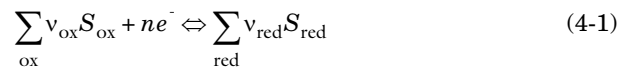

Set v_i as positive (v_{red}) for the reduced species and negative (v_{ox}) for the oxidized species in an electrochemical reaction. The number of participating electrons, n , should be positive.

If the concentration of a species in the charge conservation model for the electrolyte is based on an algebraic expression (such as the electroneutrality condition, or the water auto ionization), the stoichiometric coefficient for this species cannot be set explicitly. The stoichiometric coefficient will instead be set implicitly, based on the number of electrons and the stoichiometric coefficients of the other species participating in the reaction.



An easy way to determine the stoichiometric coefficients for a reaction is to write the reaction as a reduction reaction (with the electrons on the left), irrespectively on the expected actual direction of the reaction in the model. The species on the left side then have negative coefficients and the species on the right have positive coefficients.



- [Mass Fluxes and Sources Due to Electrochemical Reactions](#)

HEAT OF REACTION

The **Heat of Reaction** section provides two options: **Temperature derivative** and **Thermoneutral voltage** to calculate the reversible heat source of the electrode reaction, which in turn can be used for coupling to heat transfer physics.

The **Temperature derivative of equilibrium potential** parameter, dE_{eq}/dT (SI unit: V/K), can be specified in case of **Temperature derivative** selection. Note that dE_{eq}/dT parameter value has no impact on the equilibrium potential variable.

The **Thermoneutral voltage** parameter, E_{therm} (SI unit: V), can be specified in case of **Thermoneutral voltage** selection.



- [Heating Due to Electrochemical Reactions](#)
-

Double-Layer Capacitance

The **Double-Layer Capacitance** subnode describes the nonfaradaic currents due to charge and discharge of the double layer situated at the interface between the electrode and the electrolyte. The resulting double-layer current density on the boundary depends on the time derivative of the potentials and is proportional to the **Electrical double-layer capacitance** C_{dl} (SI unit: F/m²). For stationary problems, the double-layer current density is zero.

Use this node to simulate transient analysis techniques, such as AC-impedance analysis and current interrupt studies.

The parent node may be either an [Internal Electrode Surface](#) or an [Electrode Surface](#).

This subnode is not available for the Primary Current Distribution interface.

Use the settings of the **Stoichiometry** section (not available in the Primary or Secondary Current Distribution interfaces) to control what species are participating in the double-layer charging — that is, the mass exchange between the double layer and the electrolyte outside the double layer.

Perforated Electrode Surface

The Perforated Electrode Surface is applicable to internal boundaries of an electrolyte domains. The node may be used to model a thin and highly conductive perforated (mesh) electrode, immersed in an electrolyte.

Apart from the applicable selection, the node is identical to the [Electrode Surface](#) node.

Internal Electrode Surface

The **Internal Electrode Surface** node defines the electrochemical electrode-electrolyte interface between an electrode domain and the electrolyte domain. Use this node as a parent node for [Electrode Reactions](#) and the [Double-Layer Capacitance](#) of an electrolyte-electrode interface when you explicitly model the electron conducting electrode as a domain in your model.

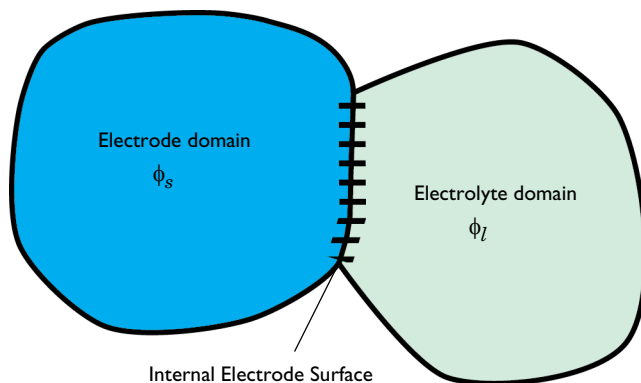

The node can be applied at interior boundaries between electrode and electrolyte domains, and to external boundaries of porous electrode domains. Note that, due to the high conductivity of many electrode materials, an [Current Conductor](#) domain can many times be replaced an external condition at the electrolyte boundary. For such cases, consider using the [Electrode Surface](#) instead.

For a description of the Film Resistance, Dissolving-Depositing Species and Constraint Settings sections, see the [Electrode Surface](#) node.



- [Electrode Reactions Theory](#)

Electrolyte Potential

Add the **Electrolyte Potential** node from **Electrolyte** submenus for boundaries, edges, and points to set a fixed potential at a position in the electrolyte. This node can be used to model half-cells, or to set the electrolyte potential at the position of, for example, a reference electrode.

The node sets the potential in the electrolyte, ϕ_L , to be equal to the **Boundary electrolyte potential**, $\phi_{L, \text{bnd}}$ (SI unit: V).

By right-clicking this node you may add a [Harmonic Perturbation](#) subnode.

CONSTRAINT SETTINGS

To display this section, click the **Show More Options** button () and select **Advanced Physics Options** in the **Show More Options** dialog box.

Electrolyte Current

The **Electrolyte Current** boundary condition sets the total current or average current density of a boundary. The condition sets the total inward current without imposing the current density distribution. It will set a constant electrolyte potential along the given boundary, that satisfies the current value setting.

When using the **Total current** option in 1D or 2D, the boundary area is based either on the **Cross-sectional area** (1D) or the **Out-of-Plane thickness** (2D) properties, set on the physics interface top node.

CONSTRAINT SETTINGS

To display this section, click the **Show More Options** button () and select **Advanced Physics Options** in the **Show More Options** dialog box.



- [Electrolyte Current Theory](#)

Electrolyte Current Density

Use the **Electrolyte Current Density** node to specify the current density distribution along a boundary.

Note that using this node in 2D or 3D may result in an uneven potential distribution along the boundary. To mitigate such effects you may use the [Electrode Current](#) node instead.

By right-clicking this node you may enable **Harmonic Perturbation**. This means that the node will only be active when solving for Frequency Domain study steps (typically used in AC Impedance studies). The frequency spectrum is specified in the study node.

Thin Electrode Layer

The **Thin Electrode Layer** node can be used to model a thin insulating or resistive sheet, located on an interior boundary in an electrode domain. The node can be used as an alternative to drawing the actual layer domain in the model geometry, which may significantly reduce meshing and solver time, especially in 3D models.

A thin electrode layer can be used to model, for instance, a contact impedance between two electronic conductors.

The layer may be set to be either **Insulating** or **Resistive**.

For the case of **Resistive**, the **Surface Resistance** can either be set directly, or calculated from **Thickness and Conductivity** values.

ADVANCED SETTINGS

Enable **Slit electrolyte potential in porous electrodes** to make the layer fully insulating for the electrolyte phase potential along the selected boundaries.

Electrode-Electrolyte Boundary Interface

Note that this is an advanced physics feature that is normally not used. To display this feature in the context menu, click the **Show More Options** button () and then select **Advanced Physics Options** in the **Show More Options** dialog box. Then add the **Electrode-Electrolyte Boundary Interface** node from the **Electrode** or **Pairs>Electrode** submenu.

Use this node to model an electrochemical interface between an electrolyte and an electrode where the electrolyte domain is not included explicitly in the model. The node can only be applied on outer boundaries to electrode domains. Set the potential of the electrolyte either explicitly, or specify a current condition that the potential of the electrode shall fulfill.

[Electrode Reaction](#) and [Double-Layer Capacitance](#) subnodes are available from the context menu (right-click the parent node) or from the **Physics** toolbar, **Attributes** menu.

This node is available for the Secondary Current Distribution and Tertiary Current Distribution, Nernst–Planck interfaces. It is also available and described here for the Battery interface.

BOUNDARY CONDITION

This section specifies the potential of the electrolyte phase for the electrolyte-electrode interface. The electrolyte potential is used (via the overpotential) by the **Electrode Reaction** subnodes.

The **Electrolyte potential** will set the potential value directly, whereas **Total current** or **Average current density** both add an extra global degree of freedom for the potential in the electrolyte phase, set to comply with the chosen condition.

When using the **Total current** option in 1D or 2D, the boundary area is based either on the **Cross-sectional area** (1D) or the **Out-of-Plane thickness** (2D) properties, set on the physics interface top node.

Electric Ground

This node sets the electric potential to zero.

The node is typically used to ground the voltage at an external boundary in a model that contains either electrode or porous electrode domains.

CONTACT RESISTANCE

Enabling **Include contact resistance** allows for a **Contact resistance** R_c (SI unit: $\Omega \cdot \text{m}^2$) to be specified and the following current density condition is used:

$$-\mathbf{n} \cdot \mathbf{i}_s = \frac{-\phi_s}{R_c}$$

CONSTRAINT SETTINGS

To display this section, click the **Show More Options** button () and select **Advanced Physics Options** in the **Show More Options** dialog box.

Electric Potential

This node sets the electric potential in the electrode (or a porous electrode), ϕ_s , to a value, $\phi_{s, \text{ bnd}}$ according to the following:

$$\phi_s = \phi_{s, \text{ bnd}}$$

The node is typically used to set the cell voltage at an external boundary in a model that contains either electrode or porous electrode domains.

CONTACT RESISTANCE

Enabling **Include contact resistance** allows for a **Contact resistance** R_c (SI unit: $\Omega \cdot \text{m}^2$) to be specified and the following current density condition is used:

$$-\mathbf{n} \cdot \mathbf{i}_s = \frac{\phi_{s, \text{bnd}} - \phi_s}{R_c}$$

By right-clicking this node you may add a [Harmonic Perturbation](#) subnode.

CONSTRAINT SETTINGS

To display this section, click the **Show More Options** button () and select **Advanced Physics Options** in the **Show More Options** dialog box.

Electrode Current Density

The **Electrode Current Density** boundary condition can be applied at an external boundary of a model that contains either electrode or porous electrode domains.

Note that using this node in 2D or 3D may result in an uneven potential distribution along the boundary. To mitigate such effects you may use the [Electrode Current](#) node instead.

By right-clicking this node you may enable **Harmonic Perturbation**. This means that the node will only be active when solving for Frequency Domain study steps (typically used in AC Impedance studies). The frequency spectrum is specified in the study node.

Electrode Current

Use the **Electrode Current** node to set the total current or average current density over an external electrode or porous electrode boundary — typically at the interface between the electrode and the current collector or current feeder. The condition sets the total inward current without imposing the current density distribution. The potential along the boundary is calculated in order to satisfy the total value of the current.

When using the **Total current** option in 1D or 2D, the boundary area is based either on the **Cross-sectional area** (1D), or the **Out-of-Plane thickness** (2D) properties, set on the physics interface top node.

CONTACT RESISTANCE

Enabling **Include contact resistance** allows for a **Contact resistance** R_c (SI unit: $\Omega \cdot \text{m}^2$) to be specified.

CONSTRAINT SETTINGS

To display this section, click the **Show More Options** button () and select **Advanced Physics Options** in the **Show More Options** dialog box.



• [Electrode Current Theory](#)

Electrode Power

The **Electrode Power** boundary condition sets the power drawn from, or inserted to, an electrical cell at external electrode boundary.

When using the **Total power** option in 1D or 2D, the boundary area is based either on the **Cross-sectional area** (1D), or the **Out-of-Plane thickness** (2D) properties, set on the physics interface top node.

CONTACT RESISTANCE

Enabling **Include contact resistance** allows for a **Contact resistance** R_c (SI unit: $\Omega \cdot \text{m}^2$) to be specified.



[Electrode Power Theory](#)

Harmonic Perturbation

Use the **Harmonic Perturbation** subnode to specify the voltage amplitude perturbation in the frequency domain. The harmonic perturbation is only applied when solving for a Frequency Domain study type, which is typically used in AC Impedance studies.

The **Harmonic Perturbation** subnode can be added to the [Electric Potential](#), [Electrolyte Potential](#). The subnode is available from the context menu (right-click the parent node) or from the **Physics** toolbar in the **Contextual** group.

The frequency spectrum is specified in the study node.

You may also specify harmonic perturbations to the [Electrode Current Density](#), [Electrolyte Current Density](#) and [Electrode Surface](#) nodes.



Frequency-Domain Perturbation Study Step in the *COMSOL Multiphysics Reference Manual*

Electrode Potential

Use the **Electrode Potential** node to set a boundary condition for the electric potential with respect to a defined reference potential.

Electric potentials defined by the [Electric Reference Potential](#) and [Reference Electrode](#) point nodes can be used as input when specifying the **Electric reference potential** $\phi_{vs,ref}$ (SI unit: V).

CONSTRAINT SETTINGS

To display this section, click the **Show More Options** button () and select **Advanced Physics Options** in the **Show More Options** dialog box.



Electrode Potentials and Reference Electrodes

External Short

Use the **External Short** node to connect two electrodes over an external connector with a given **Resistance** R (SI unit: ohm).

The boundary selected in the External Short node will be set to a constant potential, $\phi_{s,here}$, and the integrated current over the boundary will be computed according to Ohm's law:

$$\phi_s = \phi_{s, here}$$
$$\phi_{s, here} \cdot \int_{d\Omega} (\mathbf{n} \cdot \mathbf{I}_s) d\Omega = -\frac{\phi_{s, here} - \phi_{s, there}}{R}$$

where $\phi_{s,there}$ (V) is the potential of the connected electrode. Use the **Connected Potential** list to choose among available connection potentials for the value of $\phi_{s,there}$.

Initial Values for Adsorbing-Desorbing Species

The node sets the initial values for the surface coverage of adsorbing-desorbing species dependent variables.

This node is available as a subnode for the [Electrode Surface](#), [Perforated Electrode Surface](#) and [Internal Electrode Surface](#). The node is not available if no adsorbing-desorbing species are present in the parent node.

Initial Values for Dissolving-Depositing Species

The node sets the initial values for the dissolving-depositing surface concentrations dependent variables.

This node is available as a subnode for the [Internal Electrode Surface](#) and [Electrode-Electrolyte Boundary Interface](#). The node is not available if no dissolving-depositing species are present or if the **Solve for dissolving-depositing species concentrations** check box is cleared in the parent node.

Nonfaradaic Reactions

Use the **Nonfaradaic Reactions** node to define the reaction rate for dissolving-depositing species due to nonfaradaic (not electrochemical) reactions that occur on the boundary.

This node is available as a subnode to an [Electrode Surface](#) if there are dissolving-depositing species present in the parent node.

Reference Electrode

The **Reference Electrode** node is a point feature applicable to electrolyte domains. It defines a global electric reference potential and can be used in the [Electrode Potential](#) node for setting the electric potential of an electrode boundary with respect to the reference potential.

EQUILIBRIUM POTENTIAL

See [Electrode Reaction](#) for information about the settings of this section.



[Electrode Potentials and Reference Electrodes](#)

Electric Reference Potential

The **Electric Reference Potential** node is a point feature applicable to electrode domains. It defines a global electric reference potential equal to the electric potential in the point and can be used in the [Electrode Potential](#) feature for setting the electric potential of an electrode boundary with respect to the reference potential.



Electrode Potentials and Reference Electrodes

Charge-Discharge Cycling

Use the **Charge-Discharge Cycling** node to specify a load cycling boundary condition in time-dependent simulations, where the switch between charge and discharge depends on the resulting cell voltage (or current). The node may for instance be used for constant-current/constant-voltage (CCCV) cycling in battery simulations.

The node is applicable to external boundaries to electrode domains, and should typically be applied on the positive electrode of the cell.



Depending on the **Start Mode** setting, the node will either start in **Charge** or **Discharge** mode.

Each cycle always start with a constant **Discharging/Charging current** period, which ends when the corresponding **Minimum/Maximum voltage** is reached (the voltage is defined with respect to ground).

After the constant Discharging/Charging current period, you may also **Include constant voltage discharging/charging periods**, which will end when the specified **Lower cutoff current** or **Upper cutoff current** is reached. At the end of each cycle, you can also **Include rest periods**, specifying the **Resting time**.

The node also defines a cycle counter variable (`xxx.cdc1.cycle_counter`, where `xxx` is the physics interface tag), which may be used in postprocessing or when defining Stop Condition in the time-dependent solver to end the simulation when a specified number of cycles has been reached.

Note: For more complex load cycles you may use [The Events Interface](#) to set up the cycling behavior.

	For an example how to use this node, see <i>Capacity Fade of a Lithium-Ion Battery</i>
	The Events Interface



Circuit Terminal

This feature is only available with an AC/DC Module or a Battery Design Module license.

Use the **Circuit Terminal** node to specify a coupling to the **External I vs U** node in the **Electrical Circuit** interface.

	<ul style="list-style-type: none">• Connecting to Electrical Circuits
---	---

The Electrode, Shell Interface

The **Electrode, Shell (els)** interface () , found under the **Electrochemistry** branch () when adding a physics interface, models electric current conduction in the tangential direction on a boundary.

The physics interface is suitable for modeling thin electrodes where the potential variation in the normal direction to the electrode is negligible. This assumption allows for the thin electrode domain to be replaced by a partial differential equation formulation on the boundary. In this way the problem size can be reduced, and potential problems with mesh anisotropy in the thin layer can be avoided.

Ohm's law is used in combination with a charge balance to describe the conduction of currents in the shell electrode.

When this physics interface is added, these default nodes are also added to the **Model Builder** — **Electrode, Electric Insulation** (the default edge or point condition), and **Initial Values**. Then, from the **Physics** toolbar, add other nodes that implement, for example, edge or point conditions and current sources. You can also right-click **Electrode, Shell** to select physics features from the context menu.

SETTINGS

The **Label** is the default physics interface name.

The **Name** is used primarily as a scope prefix for variables defined by the physics interface. Refer to such physics interface variables in expressions using the pattern `<name>.<variable_name>`. In order to distinguish between variables belonging to different physics interfaces, the `name` string must be unique. Only letters, numbers, and underscores (`_`) are permitted in the **Name** field. The first character must be a letter.

The default **Name** (for the first physics interface in the model) is `els`.

THICKNESS



For 2D components, enter a value or expression for the **Out-of-plane thickness** d (SI unit: m). The default value is 1 m.

DEPENDENT VARIABLES

The dependent variable (field variable) is for the **Electric potential**. The name can be changed but the names of fields and dependent variables must be unique within a model.

DISCRETIZATION

To see all settings in this section, click the **Show More Options** button () and select **Advanced Physics Options** in the **Show More Options** dialog box.



- [Theory for the Electrode, Shell Interface](#)
- [Boundary, Edge, Point, and Pair Nodes for the Electrode, Shell Interface](#)



In the *COMSOL Multiphysics Reference Manual* see [Table 2-4](#) for links to common sections and [Table 2-5](#) to common feature nodes. You can also search for information: press F1 to open the **Help** window or Ctrl+F1 to open the **Documentation** window.

Boundary, Edge, Point, and Pair Nodes for the Electrode, Shell Interface

The [Electrode, Shell Interface](#) has these boundary, edge, point, and pair nodes, listed in alphabetical order, available from the **Physics** ribbon toolbar (Windows users), **Physics** context menu (Mac or Linux users), or right-click to access the context menu (all users).



In general, to add a node, go to the **Physics** toolbar, no matter what operating system you are using. Subnodes are available by clicking the parent node and selecting it from the **Attributes** menu.

These physics nodes are described in this section:

- [Boundary Current Source](#)
- [Current Source](#)
- [Electrode](#)
- [Electric Insulation](#)
- [Electric Potential](#)
- [External Current Density](#)
- [Ground](#)
- [Initial Values](#)
- [Normal Current Density](#)

These nodes are available and described for the Current Distribution interfaces, where edges (3D components) or points (2D and 2D axisymmetric components) are selected instead of boundaries.

- [Electrode Potential](#)
- [Electric Reference Potential](#)



For axisymmetric components, COMSOL Multiphysics takes the axial symmetry boundaries (at $r = 0$) into account and automatically adds an **Axial Symmetry** node to the component that is valid on the axial symmetry boundaries only.



In the *COMSOL Multiphysics Reference Manual* see [Table 2-4](#) for links to common sections and [Table 2-5](#) to common feature nodes. You can also search for information: press F1 to open the **Help** window or Ctrl+F1 to open the **Documentation** window.

Electrode

The **Electrode** node defines the current conduction in the tangential plane. Use the node to define the electrode thickness and electrical conductivity.

ELECTRODE

The **Electrode thickness** s (SI unit: m) defaults to 10^{-14} m.

The default **Electrical conductivity** σ (SI unit: S/m) uses values **From material**. Or select **User defined**. For **User defined** enter values or expressions for an isotropic or anisotropic conductivity. Select **Isotropic**, **Diagonal**, **Symmetric**, or **Full** depending on the properties

of the electrolyte. To use another type of temperature dependence than a linear temperature relation, enter any expression for the conductivity as a function of temperature. Then enter a value or expression in the field or matrix.



Initial Values

The **Initial Values** node adds the electric potential that can serve as an initial guess for a nonlinear solver. If more than one initial value is needed, add **Initial Values** nodes from the **Physics** toolbar.

INITIAL VALUES

Enter values or expressions for the **Electric potential** (SI unit: V). The default value is 0 V.

External Current Density

Use the **External Current Density** node to define the external current density.

EXTERNAL CURRENT DENSITY

Based on space dimension, enter the vector components (**x**, **y**, and **z** for 3D components, **x** and **y** for 2D, or **r** and **z** for 2D axisymmetric components) of the **External current density** \mathbf{i}_e (SI unit: A/m²). The defaults are 0 A/m².

Current Source

The **Current Source** node adds a source term to [Equation 4-7](#). Use this node to define the current source.

ELECTRODE CURRENT SOURCE

Enter a value or expression for the **Current source** Q_i (SI unit: A/m³). The default is 0 A/m³.

Normal Current Density

The **Normal Current Density** node is applicable to exterior boundaries that represent either a source or a sink of current. It sets a condition for the current density according to:

$$\nabla_T \cdot \mathbf{i}_s = i_n$$

The node can be used to couple the Electrode, Shell interface to the electrode reactions in an Electrochemistry interface that describes the electrolyte currents in the adjacent domain.

NORMAL CURRENT DENSITY

Enter a value for the **Electrode current source** i_n (SI unit: A/m²). The default is 0 A/m².

Electric Insulation

The **Electric Insulation** node is the default edge (3D components) and point (2D and 2D axisymmetric components) condition and describes the edges of the shell (boundary) that do not conduct electricity.

Boundary Current Source

The **Boundary Current Source** node is available on edges (3D components) and points (2D and 2D axisymmetric components) and sets a condition for the current density according to:

$$\mathbf{i}_s \cdot \mathbf{n} = i_{s,0}$$

BOUNDARY CURRENT SOURCE

Enter a value or expression for the **Inward current density** $i_{s,0}$ (SI unit: A/m²). The default is 0 A/m².

Ground

The **Ground** node is available on edges (3D components) and points (all components) and sets the potential according to $\phi_s = 0$.

EDGE OR POINT SELECTION



Beware that constraining the potential on edges or points in 3D or on points in 2D usually yields a current outflow that is mesh dependent.

CONSTRAINT SETTINGS

To display this section, click the **Show More Options** button () and select **Advanced Physics Options** in the **Show More Options** dialog box.

Electric Potential

The **Electric Potential** node is available on edges (3D components) and points (all components) and sets the potential according to $\phi_s = \phi_{s,0}$.

EDGE OR POINT SELECTION



Beware that constraining the potential on edges or points in 3D or on points in 2D usually yields a current outflow that is mesh dependent.



ELECTRIC POTENTIAL

Enter the value or expression for the **Electric potential** $\phi_{s,0}$ (SI unit: V).

CONSTRAINT SETTINGS

To display this section, click the **Show More Options** button () and select **Advanced Physics Options** in the **Show More Options** dialog box.

The Electroanalysis Model Wizard Entry

The **Electroanalysis (tcd)** () model wizard entry, found under the **Electrochemistry** branch () adds a **Tertiary Current Distribution, Nernst–Planck interface** to the model with the **Electrolyte Charge Conservation Model** set to **Electroanalysis** by default.

The Electroanalysis option is suitable for modeling mass transport of diluted species in electrolytes using the diffusion-convection equation, solving for electroactive species concentrations.

The [Tertiary Current Distribution, Nernst-Planck Interface](#) also features options for modeling cyclic voltammetry and electrochemical impedance spectroscopy.

Use this model wizard entry to model electroanalytical problems with electrolyte solutions containing a large quantity of inert “supporting” electrolyte. Ohmic loss is assumed to be negligible.

The model wizard entry is available in 1D, 2D, and 3D as well as for axisymmetric components in 1D and 2D.

The default dependent variables are the molar concentrations, c_1 and c_2 , of the two electroactive species in a redox couple and the electric potential, ϕ_{is} , which is solved for either in the Electrode or Porous Electrode domain feature.



- [The Tertiary Current Distribution, Nernst-Planck Interface](#)
 - [Introduction to Electrochemistry Modeling](#)
 - [Theory for Electroanalysis](#)
-

Theory for the Current Distribution Interfaces

In this section:

- The Nernst–Planck Equations
- Domain Equations for Primary and Secondary Current Distributions
- Electrochemical Reactions and the Difference Between a Primary and a Secondary Current Distribution
- Domain Equations for Tertiary Current Distributions Using the Nernst–Planck Equations and Electroneutrality
- Mass Fluxes and Sources Due to Electrochemical Reactions
- Deposition-Dissolution Rates, Growth Velocities, and Thicknesses on an Electrode Surface
- Stoichiometric Coefficients for Double Layer Capacitive Charging
- Film Resistance
- Electrode Kinetics Expressions
- Theory for Specific Current Distribution Feature Nodes



This theory is also relevant to the Current Distribution on Edges, BEM interface. However, due to the use of BEM, current source terms in the electrolyte, and porous electrodes, cannot be used in this interface.

The Nernst–Planck Equations

The general mass balance for the diluted species in an electrolyte is described by the following equations for each species i :

$$\frac{\partial c_i}{\partial t} + \nabla \cdot \mathbf{N}_i = R_{i, \text{tot}}$$

where \mathbf{N}_i is the total flux of species i (SI unit: mol/(m²·s)). The flux in an electrolyte is described by the Nernst–Planck equations and accounts for the flux of charged solute

species (ions) by diffusion, migration, and convection; these are respectively the first, second, and third term on right side in the equation below.

$$\mathbf{N}_i = -D_i \nabla c_i - z_i u_{m,i} F c_i \nabla \phi_l + c_i \mathbf{u} = \mathbf{J}_i + c_i \mathbf{u}$$

where

- c_i represents the concentration of the ion i (SI unit: mol/m³),
- z_i its valence,
- D_i the diffusion coefficient (SI unit: m²/s),
- $u_{m,i}$ its mobility (SI unit: s·mol/kg),
- F denotes the Faraday constant (SI unit: C/mol),
- ϕ_l the electrolyte potential,
- \mathbf{u} is, the velocity vector (SI unit: m/s), and
- \mathbf{J}_i denotes the molar flux relative to the convective transport.

$$\mathbf{J}_i = -D_i \nabla c_i - z_i u_{m,i} F c_i \nabla \phi_l \quad (4-2)$$

The net current density can be described using the sum of all species fluxes:

$$\mathbf{i}_l = F \sum z_i \mathbf{N}_i$$

where \mathbf{i}_l denotes the current density vector (SI unit: A/m²) in the electrolyte.

Domain Equations for Primary and Secondary Current Distributions

Assuming electroneutrality (which cancels out the convection term) and negligible concentration gradients of the current-carrying ion (which cancels out the diffusion term), the following expression is left for the current density vector in an electrolyte:

$$\mathbf{i}_l = -F^2 \sum z_i^2 u_{m,i} c_i \nabla \phi_l.$$

Further, assuming approximately constant composition of charge carriers, we can define a constant electrolyte conductivity as:

$$\sigma_l = F^2 \sum z_i^2 u_{m,i} c_i$$

the current density in the electrolyte can be written as

$$\mathbf{i}_l = -\sigma_l \nabla \phi_l$$

This equation takes the same form as Ohm's law; in an electrolyte, charge transport is ohmic, subject to the above assumptions.

Conservation of charge yields the domain equation usually used for the electrolyte in the Primary and Secondary Current Distribution interfaces:

$$\nabla \cdot \mathbf{i}_l = 0$$



In a pore electrolyte, the homogenization used in the theory for porous electrodes introduces a source or sink term in the pore electrolyte current balances due to the charge transfer reactions at the electrode-electrolyte interface within the porous material. In such cases, a source term, Q_b , is introduced on the right-hand side of the equation above.

The Primary and Secondary Current Distribution interfaces define two dependent variables: one for the potential in the electrolyte and one for the electric potential in the electrode. The conduction of current in the electrolyte is assumed to take place through transport of ions as described above, while electrons conduct the current in the electrode.

Since Ohm's law is also used for current conduction in the solid electrode phase, the general equation in these interfaces is according to the following:

$$\nabla \cdot \mathbf{i}_k = Q_k$$

with

$$\mathbf{i}_k = -\sigma_k \nabla \phi_k$$

where Q_k denotes a general source term, k denotes an index that is l for the *electrolyte* or s for the *electrode*, σ_k denotes the conductivity (SI unit: S/m) and ϕ_k the potential (SI unit: V).

Electrochemical Reactions and the Difference Between a Primary and a Secondary Current Distribution

Both the primary and secondary current distribution models assume an electrolyte that conducts current according to Ohm's law, with a constant conductivity. The difference between a primary and a secondary current distribution lies in the description of the

electrochemical *charge transfer reaction* at the interface between an electrolyte and an electrode. The charge transfer reactions can be defined as boundary conditions, or as sources or sinks in a domain for the case of *porous electrodes*.

The rate of the electrochemical reactions can be described by relating the reaction rate to the activation *overpotential*. For an electrode reaction, with index m , the activation overpotential, denoted η_m , is the following:

$$\eta_m = \phi_s - \phi_l - E_{\text{eq}, m}$$

where $E_{\text{eq}, m}$ denotes the *equilibrium potential* (also known as a reduction potential) for reaction m .

In the Primary Current Distribution interface, the electrochemical reactions are assumed to be fast enough that their kinetics have negligible influence on the cell voltage. Consequently, the activation overpotential, η_m , in this physics interface is equal to zero, and the difference in potential between the electrode and the electrolyte is always equal to the equilibrium potential, $E_{\text{eq}, m}$. This condition is implemented as the following constraint on boundaries between electrodes and electrolyte domains:

$$\phi_l = \phi_s - E_{\text{eq}, m}$$



A good modeling practice is to estimate the influence of finite reaction kinetics on the cell voltage and to compare the associated activation losses to the ohmic losses in a cell to check the validity of the primary current distribution assumption.

In the Secondary Current Distribution interface, the electrochemical reactions are described as a function of the overpotential. The physics interface uses several relations for the charge transfer current density and the overpotential, such as Butler–Volmer and Tafel expressions. The most general expression is of Butler–Volmer type:

$$i_{\text{loc}, m} = i_{0, m} \left(\exp\left(\frac{\alpha_{a, m} F \eta_m}{RT}\right) - \exp\left(\frac{-\alpha_{c, m} F \eta_m}{RT}\right) \right)$$

where $i_{loc,m}$ denotes the local charge transfer current density for reaction m , $i_{0,m}$ the exchange current density, $\alpha_{a,m}$ the anodic transfer coefficient, $\alpha_{c,m}$ the cathodic charge transfer coefficient, F Faraday's constant, and R the universal gas constant.



Both the exchange current density and the overpotential are typically concentration dependent. It is possible to include the dependence of kinetics on concentration in the expression above. It is also possible to use other kinetics expressions.

See [Equilibrium Potentials and the Nernst Equation](#) and [Electrode Kinetics Expressions](#).

The sum of all electrode reaction currents is implemented as a current density condition on the boundary between an electrode and an electrolyte domain according to:

$$\mathbf{i}_l \cdot \mathbf{n} = \sum_m i_{loc,m}$$

$$\mathbf{i}_s \cdot \mathbf{n} = -\sum_m i_{loc,m}$$

Both the Primary Current Distribution and Secondary Current Density Distribution interfaces allow for a domain definition for porous electrodes. For the Primary Current Distribution interface, the same constraint as above is applied.

In porous electrodes for the Secondary Current Distribution interface, the sum of all reaction currents appears as a source in the domain equations:

$$\nabla \cdot \mathbf{i}_l = \sum_m A_{v,m} i_{loc,m}$$

$$\nabla \cdot \mathbf{i}_s = -\sum_m A_{v,m} i_{loc,m}$$

where $A_{v,m}$ is the surface area.



The only reason to add Porous Electrode descriptions to the Primary Current Distribution interface is to be able to expand a model to include charge transfer resistance.

Domain Equations for Tertiary Current Distributions Using the Nernst–Planck Equations and Electroneutrality

The domain equations can be derived by starting with [The Nernst–Planck Equations](#). The material balance equation for each species i in the electrolyte is given by the continuity equation, with a flux given by the Nernst–Planck equation:

$$\frac{\partial c_i}{\partial t} + \nabla \cdot (\mathbf{J}_i + c_i \mathbf{u}) = R_{i, \text{tot}}$$

where

- c_i denotes the concentration of species i (SI unit: mol/m³),
- \mathbf{u} is, the velocity vector (SI unit: m/s), and
- \mathbf{J}_i denotes the molar flux relative to the convective transport (see [Equation 4-2](#))

The material balances give one equation per unknown species concentration.



The concentration gradients are not assumed to be negligible here, and so the contribution of ion diffusion to overall current density can be nonzero. (Compare with the [Domain Equations for Primary and Secondary Current Distributions](#).)

There is one more unknown dependent in the variable, the *electrolyte potential*, which requires an additional equation to close the system. This equation is the electroneutrality condition, which follows from dimensional analysis of Gauss's law. In a typical electrolyte solution, it is accurate over lengths greater than a few nanometers:

$$\sum z_i c_i = 0$$

Using the electroneutrality condition reduces the number of dependent concentration variables by one.

Further, by combining the electroneutrality condition with the sum of all species flux vectors and the species mass balance equation, multiplied by the individual species charges, results in expressions for the current vector and a current balance equation, respectively.

The expression for the current density in the electrolyte, \mathbf{i}_l , reads:

$$\mathbf{i}_l = F \sum_{i=1}^n z_i (-D_i \nabla c_i - z_i u_{m,i} F c_i \nabla \phi_l) = F \sum_{i=1}^n z_i \mathbf{J}_i$$

whereas current balance in the electrolyte, used for solving for the electrolyte potential, then becomes:

$$\nabla \cdot \mathbf{i}_l = Q_l$$

where Q_l can here be any source or sink. (Q_l is typically nonzero for porous electrodes). These formulations are also valid for the pore electrolyte in porous electrodes, except for the transport properties that have to be corrected for porosity and tortuosity. In such cases, the source or sink, Q_l , denotes the charge transfer reactions in the porous electrode and/or the nonfaradaic source or sink due to double layer charge and discharge.

The charge transfer reaction can be parameterized by arbitrary functions of the concentrations of the species in the redox couple and the local electric and electrolyte potentials. The most common way to describe the reaction kinetics is to use a Butler–Volmer expression for the charge transfer current density. See [The Butler–Volmer Equation](#).

In the current balance in a porous electrode, the local current density multiplied by the specific surface area of an electrode gives a contribution to the source or sink, Q_l , due to electrochemical reactions.

Mass Fluxes and Sources Due to Electrochemical Reactions

When relating the species fluxes at an electrode surface to the electrical currents, the general electrochemical reaction formula:

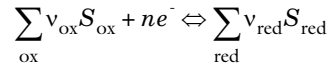

is used to define the stoichiometric coefficients, ν_i , with ν_i being positive (ν_{red}) for products and negative (ν_{ox}) for the reactants in a reduction reaction. The number of participating electrons, n , is always positive.

The molar species fluxes, N_i (SI unit: mol/(m²·s)), perpendicular to an electrode-electrolyte interface are calculated by summing all the flux contributions from the electrode reactions of index m , according to Faraday's laws:

$$N_i = \sum_m \frac{v_{i,m} i_{loc,m}}{n_m F}$$

where $i_{loc,m}$ is the local current density (SI unit: A/m²) of the electrochemical reaction, n_m the number of participating electrons and F (SI unit: C/mol) is the *Faraday constant*. Note that $i_{loc,m}$ denotes the current density perpendicular to the electrode surface.

The molar species flux, N_i , is obtained from the normal component of the molar species flux vector over the electrode-electrolyte interface:

$$N_i = \mathbf{N}_i \cdot \mathbf{n}$$

where \mathbf{n} is the normal vector of the boundary pointing into the domain.

For a porous electrode, the electrochemical reactions result in species source terms calculated from:

$$R_{i, \text{molar}} = - \sum_m a_{v,m} \frac{v_{i,m} i_{loc,m}}{n_m F}$$

where $a_{v,m}$ (SI unit: m²/m³) is the specific surface area.

Deposition-Dissolution Rates, Growth Velocities, and Thicknesses on an Electrode Surface

The rate of dissolution or deposition on due to an electrode reaction is defined based on the reaction stoichiometry, $v_{i,m}$, and the local current density, $i_{loc,m}$, as described in [Mass Fluxes and Sources Due to Electrochemical Reactions](#).

If the reaction rate is known, the total growth $v_{\text{dep, tot}}$ (m/s) is defined as the sum of the velocity contributions for all species and electrode reactions according to:

$$v_{\text{dep, tot}} = - \sum_i \frac{M_i}{\rho_i} \sum_m \frac{v_{i,m} i_{loc,m}}{n_m F} \quad (4-3)$$

Where M_i (SI unit: kg/mol) is the molar mass and ρ_i (SI unit: kg/m³) the density of the species. (i is the species index, and m the index of the electrode reaction).

This velocity may be used in deforming geometry models as a boundary condition for the geometry deformation by assuming that dissolution or deposition always occurs in

the normal direction to an electrode boundary, with the velocity being directed into the electrolyte domain:

$$\frac{\partial \mathbf{x}}{\partial t} \cdot \mathbf{n} = v_{\text{dep, tot}}$$

In a time-dependent simulation one may also introduce a surface concentration variable, $c_{s,i}$ (mol/m²) on the boundary and calculate the accumulated surface concentration change by using a local ordinary differential equation (ODE):

$$\frac{dc_{s,i}}{dt} = -\sum_m \frac{v_{i,m} i_{\text{loc},m}}{n_m F}$$

The total deposited thickness s_{tot} (m) can then be defined as

$$s_{\text{tot}} = \sum_i \frac{M_i}{\rho_i} c_{s,i}$$

Stoichiometric Coefficients for Double Layer Capacitive Charging

A negative capacitive current corresponds to the accumulation of negative charge on the electrode surface, and a corresponding counterbalanced positive charge accumulating in the double layer. This can be understood in terms of conservation of current: cathodic capacitive current at the electrode corresponds to the overall injection of negative charge (from the double layer) into the electrolyte, just as a cathodic Faradaic current would add negative charge to the electrolyte through electron transfer.

Consider an overall reaction as:

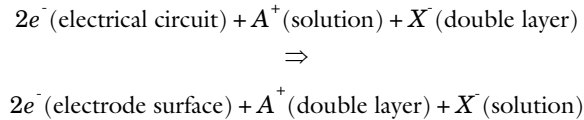

This corresponds to a negative charge of $2F$ being moved from double layer to solution. Following the convention that the reaction is written in the order of cathodic current (as above), then with respect to the free solution species, the cation is a reactant (negative stoichiometry) and the anion is a product (positive stoichiometry). This suggests $v_A = -1$, $v_X = +1$, and $n = 2$ for an ideal double layer where both anion and cation have similar contributions to the double layer charge.

Film Resistance

If a resistive film forms on the interface between an electrode and an electrolyte, this results in additional potential losses. To model a film resistance, an extra dependent variable for the potential drop over the film, $\Delta\phi_{s, \text{film}}$, is introduced. The governing equation is:

$$\Delta\phi_{s, \text{film}} = i_{\text{tot}} R_{\text{film}}$$

Where R_{film} (SI unit: ohm·m²) is a generalized film resistance and i_{tot} the sum of all currents over the interface. The activation overpotentials, η_m , for all occurring electrode reactions on the electrode with the film receive an extra potential contribution due to the film resistance according to:

$$\eta_m = \phi_s - \Delta\phi_{s, \text{film}} - \phi_l - E_{0, m}$$

If the thickness and conductivity of the film are known, the resistance can be written as:

$$R_{\text{film}} = \frac{s_0 + \Delta s}{\sigma_{\text{film}}}$$

where s_0 is the reference/initial film thickness, Δs the electrode thickness change, and σ_{film} the conductivity (SI unit: S/m) of the film.

Equilibrium Potentials and the Nernst Equation

Consider an arbitrary, possibly multi-electron step, redox reaction involving a number of species S_i defined as

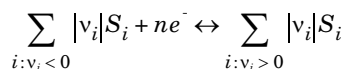

where v_i is the stoichiometric coefficient of the reacting species of index i and n is the number of participating electrons.

The equilibrium potential of the electrode reaction, E_{eq} (V), is the electrode potential (the difference between the electrode phase and electrolyte phase potentials, $\phi_s - \phi_l$) for which the net reaction rate (and the local current density, i_{loc}) is zero.

The equilibrium potential is directly related to the change of Gibbs free energy of the reacting species, ΔG , as

$$E_{\text{eq}} = -\frac{\Delta G}{nF}$$

Since the free energy of the reacting species is concentration dependent, also the equilibrium potential is concentration (activity) dependent. E_{eq} is usually defined according to the Nernst equation as

$$E_{\text{eq}} = E_{\text{eq, ref}} - \frac{RT}{nF} \ln \prod_i \left(\frac{a_i}{a_{i, \text{ref}}} \right)^{\nu_i}$$

where $E_{\text{eq, ref}}$ (V) is the equilibrium potential for a reference state for which all species activities a_i (unitless) are equal to a chosen set of reference activities $a_{i, \text{ref}}$ (unitless).

For ideal solutions, the activities are replaced by concentrations. Standard conditions correspond to reference concentrations of 1M for soluble species in the electrolyte, partial pressures of 1 atm for gaseous species. Constant activities of 1 is used for solid (metal) species and solvents.

Electrode Kinetics Expressions

A number of different analytical expressions for the current density perpendicular to the electrode surface, $i_{\text{loc}, m}$, are available. In the following paragraphs, the index m is dropped. All parameters are understood to refer to a specific reaction.

THE EQUILIBRIUM POTENTIAL AND THE OVERPOTENTIAL

The rate of the electrochemical reactions can be described by relating the reaction rate to the activation overpotential. For an electrode reaction, the activation overpotential, denoted η (V), is the following:

$$\eta = \phi_s - \phi_l - E_{\text{eq}}$$

where E_{eq} denotes the equilibrium potential.

THE BUTLER-VOLMER EQUATION

A common expression for the current density as a function of the activation overpotential, in modeling of electrochemical systems, is the Butler–Volmer equation:

$$i_{\text{loc}} = i_0 \left(\exp\left(\frac{\alpha_a F \eta}{RT}\right) - \exp\left(\frac{-\alpha_c F \eta}{RT}\right) \right)$$

where α_c (unitless) denotes the cathodic charge transfer coefficient, α_a (unitless) the anodic charge transfer coefficient, and i_0 (SI unit: A/m²) is the exchange current density.

It should be noted that, although used extensively for all sorts of reactions in the electrochemical community, the Butler–Volmer equation was originally derived for single-electron transfer reactions (for instance implying that the reaction does not involve the breaking or creation of a chemical bond).

Concentration Dependence and the Exchange Current Density

The exchange current density is generally concentration dependent. For certain conditions, it is possible to derive analytical expressions for i_0 . Assuming a concentration dependent equilibrium potential defined by the Nernst equation (see previous section [Equilibrium Potentials and the Nernst Equation](#)), the kinetics to follow the law of mass action, and the condition that $\alpha_a + \alpha_c = n$, then the exchange current density becomes as follows:

$$i_0 = i_{0, \text{ref}} \prod_{i: v_i > 0} \left(\frac{a_i}{a_{i, \text{ref}}} \right)^{\frac{\alpha_c v_i}{n}} \prod_{i: v_i < 0} \left(\frac{a_i}{a_{i, \text{ref}}} \right)^{\frac{-\alpha_a v_i}{n}}$$

where $i_{0, \text{ref}}$ is the exchange current density (SI unit: A/m²) at the reference state. The above expression can be derived from the mass action law, which gives the following expression for the local current density:

$$i_{\text{loc}} = i_{0, \text{ref}} \left(\prod_{i: v_i > 0} \left(\frac{a_i}{a_{i, \text{ref}}} \right)^{v_i} \exp\left(\frac{\alpha_a F \eta_{\text{ref}}}{RT}\right) - \prod_{i: v_i < 0} \left(\frac{a_i}{a_{i, \text{ref}}} \right)^{-v_i} \exp\left(\frac{-\alpha_c F \eta_{\text{ref}}}{RT}\right) \right)$$

where the overpotential η_{ref} (SI unit: V) is measured using relative to a reference state, which yields:

$$\eta_{\text{ref}} = \phi_s - \phi_l - E_{\text{eq, ref}}$$

This latter form of the Butler–Volmer equation, where the reference overpotential and the exchange current density do not vary with concentration, is usually preferable numerically.

The law of mass action is usually not suitable for defining complex reactions involving multiple electron steps. For certain multi-electron reactions, where one electron transfer step is rate limiting, it is possible to derive a lumped Butler–Volmer expressions using the following relation for the exchange current density (see [Ref. 1](#)):

$$i_0 = i_{0, \text{ref}} \prod_i \left(\frac{a_i}{a_{i, \text{ref}}} \right)^{\gamma_i}$$

where γ_i are generic exponential coefficients. For this case, α_a and α_c may be independently defined. By rearranging the Butler–Volmer expression using η_{ref} similarly to what was done for the mass action law case above, the γ_i coefficients relate to the anodic, $\xi_{a,i}$, or cathodic, $\xi_{c,i}$, reaction orders according to

$$\xi_{a,i} = \gamma_i + \frac{\alpha_a \nu_i}{n}$$

and

$$\xi_{c,i} = \gamma_i - \frac{\alpha_c \nu_i}{n}.$$

Exchange Current Density and Rate Constants

In electroanalysis, one commonly defines electrode kinetics in terms of rate constants rather than exchange current densities.

For instance, for a one electron redox couple of concentrations c_o and c_r , with the same reference concentration c_{ref} for both species, and $i_{0, \text{ref}} = k_0 F c_{\text{ref}}$, the mass action law expression above can be rewritten as

$$i_{\text{loc}} = k_0 F \left(c_r \exp\left(\frac{\alpha_a F \eta}{RT}\right) - c_o \exp\left(\frac{-\alpha_c F \eta}{RT}\right) \right)$$

where k_0 (m/s) is the heterogeneous rate constant.

Generic Concentration Dependent Butler–Volmer Type Kinetics

This expression type gives more freedom for the user to define concentration dependent Butler–Volmer types of expressions, where the anodic and cathodic terms of the current density expression, typically depending on the local concentrations of the electroactive species at the electrode surface, may be individually defined:

$$i_{\text{loc}} = i_0 \left(C_R \exp\left(\frac{\alpha_a F \eta}{RT}\right) - C_O \exp\left(\frac{-\alpha_c F \eta}{RT}\right) \right)$$

Here C_R and C_O are dimensionless expressions, describing the dependence on the reduced and oxidized species in the reaction. Note that if $C_O \neq C_R$ when $\eta = 0$, this kinetics expression results in $i_{\text{loc}} \neq 0$, thus violating the concept of equilibrium. This

may result in thermodynamical inconsistencies, for instance when coupling an electrochemical model to heat transfer.

SIMPLIFICATIONS OF THE BUTLER–VOLMER EQUATION

Linearized Butler–Volmer

The charge transfer reaction can be expressed by a linearized Butler–Volmer expression, which can be used for small overpotentials ($\eta \ll RT/F$) and is usually referred to as the low-field approximation. This approximation gives the following linearized equation:

$$i_{\text{loc}} = i_0 \left(\frac{(\alpha_a + \alpha_c)F}{RT} \right) \eta$$

Anodic and Cathodic Tafel Equations

By assuming either high anodic or cathodic overpotentials for a given current (that is, slow kinetics or low i_0), one of the terms in the original Butler–Volmer potentials can be neglected.

The anodic Tafel equation is implemented as follows:

$$i_{\text{loc}} = i_0 \cdot 10^{\eta/A_a}$$

where A_a (SI unit: V) is the so-called Tafel slope. A_a relates to the corresponding transfer coefficient as follows

$$A_a = \frac{RT \ln 10}{\alpha_a F}$$

The cathodic Tafel expression is defined according to:

$$i_{\text{loc}} = -i_0 \cdot 10^{\eta/A_c}$$

where the sign accounts for the negative cathodic charge transfer current. Here, A_c is required to be negative and relates to the transfer coefficient according to

$$A_c = -\frac{RT \ln 10}{\alpha_c F}$$

LIMITING CURRENT DENSITY

The steady-state rate of electrode reactions can never exceed the rate at which reactants and products can be transported to and from the electrode surface. When explicitly including mass transport in a model, this dependence is typically described in concentration dependence of the equilibrium potential and the exchange current density as described above.

When not explicitly including mass transfer in the domain equations one can still include the effect of transport limitations by the assumption of a Nernst diffusion layer at the electrode surface, and a first-order dependence between the charge transfer current and the local concentration of a reacting species, resulting in the following kinetics expression:

$$i_{\text{loc}} = \frac{i_{\text{expr}}}{1 + \left\| \frac{i_{\text{expr}}}{i_{\text{lim}}} \right\|}$$

where i_{expr} (A/m^2) is the current density expression in the absence of mass transport limitations for the species, and i_{lim} (A/m^2) is the limiting current density that corresponds to the maximum transport rate of the species. The derivation of this expression assumes high overpotentials so that either the anodic or a cathodic term in the Butler–Volmer equation may be neglected.

LINEARIZE CONCENTRATION DEPENDENCE FOR LOW CONCENTRATIONS

Consider a concentration-based kinetic expression

$$\frac{dc}{dt} = r = -kc^v$$

where v and k are positive numbers and the desired behavior is that the rate r and the concentration c should equal zero in the converged solution at infinite time. However, if c , due to numerical fluctuations in the solver process, becomes negative during iterating, issues may arise.

First consider the case when v equals 1 (or any odd positive integer). Negative values of c will then cause the rate to become positive, resulting in a “self-stabilizing” situation where c will be approaching 0 with time.

A second case to consider is when v is an even integer larger than 1. The rate then will become increasingly negative for negative values of c , resulting in an “exploding” solution, iterating c toward minus infinity. The standard solution for these cases, which

also works for noninteger ν values larger than 1, is to change the expression c in the rate term to $\max(c, \text{eps})$, where eps is a small number. This will avoid the “exploding” behavior, but result in poor convergence rate for negative c values since the Jacobian of the rate with respect to c then becomes zero for negative c values.

The third case is when ν is a noninteger between 0 and 1. Note now that Jacobian with respect to c of the rate expression now contains $c^{\nu-1}$, which will approach minus infinity when c approaches zero from the positive side. This may result in poor convergence, and the $\max()$ wrapping will not improve convergence in this case.

The solution for the third case is to linearize the concentration dependence for low concentrations; that is, to use

$$r = -kc^\nu \quad c > c_{\text{lim}}$$

$$r = -kcc_{\text{lim}}^{\nu-1} \quad c \leq c_{\text{lim}}$$

which results in the desired convergence behavior for low and negative concentrations. Note, however, that the linearization may result in thermodynamic inconsistencies so that, for instance, relations like the Nernst equation for the equilibrium potential are no longer fulfilled. The linearization may also improve convergence of the second case above.

Theory for Specific Current Distribution Feature Nodes

ELECTROLYTE THEORY

The Electrolyte node defines a current balance in the electrolyte. The domain equation is:

$$\nabla \cdot \mathbf{i}_l = 0$$

where \mathbf{i}_l denotes the current density vector. In free electrolyte, there is no source or sink of charge.

The definition of the current density vector depends on the equation formulation of the electrolyte charge transport, as discussed above in [Domain Equations for Primary](#)

and Secondary Current Distributions and Domain Equations for Tertiary Current Distributions Using the Nernst–Planck Equations and Electroneutrality.



- For the Primary and Secondary Current Distribution interfaces, see [Electrolyte](#).
- For the Tertiary Current Distribution, Nernst–Planck interface, see [Electrolyte](#).

POROUS ELECTRODE THEORY

A porous electrode is a mixed material with one electrode phase and one electrolyte phase. (A special case of a porous electrode is the gas diffusion electrode, as found in a fuel cell. These contain a gas pore phase which is inert to charge transfer.) To model a porous electrode we define two separate current balances according to the following equations:

$$\nabla \cdot \mathbf{i}_l = Q_l \text{ and } \nabla \cdot \mathbf{i}_s = Q_s$$

In these equations, \mathbf{i}_l denotes the current density vector in the electrolyte, as discussed above in [Domain Equations for Primary and Secondary Current Distributions](#) and [Domain Equations for Tertiary Current Distributions Using the Nernst–Planck Equations and Electroneutrality](#).

In addition to the current balances, it is necessary to also formulate mass balance equations for the species in the electrolyte phase for the tertiary case.

It is also common to use corrected conductivities and diffusion parameter values in a porous electrode to account for the lowered volume fraction of the conducting phase, and the longer transport distance due to the tortuosity of the pores.

The current balances in the pore electrolyte and in the electrode matrix contain sources and sinks according to the charge transfer reactions that take place in the electrode catalyst. For example, if only one charge transfer reaction takes place in the porous electrode, the domain equations are the following:

$$\begin{aligned}\nabla \cdot \mathbf{i}_l &= A_v i_{loc} \\ \nabla \cdot \mathbf{i}_s &= -A_v i_{loc}\end{aligned}$$

where A_v denotes the specific surface area (dimension L^2/L^3), and i_{loc} the local current density defines the rate of the charge transfer reactions, for instance according

to the Butler–Volmer equation. For various ways of defining i_{loc} see [Electrode Kinetics Expressions](#).

If the porous electrode is a cathode, then the charge transfer reaction is a source for the current balance in the electrode, because it receives current from the pore electrolyte. The charge transfer reaction is then a sink for the current balance in the pore electrolyte, because the current is transferred from the pore electrolyte to the electrode in a cathodic reaction.

The corresponding sources and sinks in the current balances that are due to the charge transfer reactions are also coupled to the material balances for the charged species. This means that the local current density expression above is also included in the material balances as a reaction term, R_i , by using Faraday's laws for each of the species that take part in charge transfer reactions.



- For the Primary and Secondary Current Distribution interfaces, see [Porous Electrode](#).
- For the Tertiary Current Distribution, Nernst–Planck interface, see [Porous Electrode](#).

ELECTRODE REACTIONS THEORY

Charge transfer reactions occurring at an interface between an electrode and an electrolyte domain gives rise to a normal current flux that equals the sum of all reaction currents according to

$$\mathbf{i}_l \cdot \mathbf{n} = \sum_m i_{loc, m}$$
$$\mathbf{i}_s \cdot \mathbf{n} = -\sum_m i_{loc, m}$$

where $i_{loc, m}$ (A/m^2) is the [Electrode Reaction](#) current density of the charge transfer electrode reaction of index m , \mathbf{i}_l the current density vector in the electrolyte and \mathbf{i}_s the current density vector in the electrode.

POROUS ELECTRODE REACTIONS THEORY

For a porous electrode, the electrode reaction current densities are multiplied by the surface area to yield a source or sink in the current balance domain equation according to:

$$\nabla \cdot \mathbf{i}_l = \sum_m A_v i_{\text{loc}, m}$$

$$\nabla \cdot \mathbf{i}_s = -\sum_m A_v i_{\text{loc}, m}$$

where A_v is the specific surface area of the electrocatalyst.



Porous Electrode Reaction

ELECTRODE THEORY

Electron conduction in an [Electrode](#) is modeled using Ohm's law. The domain equation is the following:

$$\nabla \cdot \mathbf{i}_s = 0$$

where \mathbf{i}_s denotes the current density vector according to:

$$\mathbf{i}_s = -\sigma_s \nabla \phi_s$$

and where σ_s denotes the electrical conductivity and ϕ_s the potential of the electron conducting (metal) phase.

ELECTROLYTE CURRENT DENSITY THEORY

An applied current density can be defined as its component perpendicular to the boundary according to:

$$\mathbf{i}_l \cdot \mathbf{n} = i_{n, l}$$

The current density can also be defined including all its components:

$$\mathbf{i}_l = \mathbf{i}_{l, \text{bnd}}$$

where $\mathbf{i}_{l, \text{bnd}}$ is a given expression for the current density vector.



Electrolyte Current Density

ELECTROLYTE CURRENT THEORY

The **Electrode Current** boundary condition sets the total current at a given position in the electrolyte without imposing a current density distribution. The conditions yields a constant electrolyte potential, along the given boundary, that satisfies the total value of the current. The boundary condition is a good choice in the middle of a cell with planar electrodes, where the isopotential level can be a plane (or close to a plane in 3D, or line in 2D) but where the current density distribution is unknown.

The feature adds one unknown variable, the electrolyte potential, $\phi_{l, \text{bnd}}$, along the boundary. It then adds one additional equation for the total current, which is an integral over the boundary:

$$\int_{\partial\Omega} \mathbf{i}_l \cdot \mathbf{n} ds = I_{n, l}$$

The average current density condition imposes the same equation but multiplies the current density by the area of the boundary to obtain the value of the total current $I_{n, l}$.

ELECTRODE CURRENT THEORY

The **Electrode Current** adds one unknown variable, the electric potential, $\phi_{s, \text{bnd}}$, along the boundary. It then adds one additional equation for the total current, which is an integral over the boundary:

$$\int_{\partial\Omega} \mathbf{i}_s \cdot \mathbf{n} ds = I_{n, s}$$

where

$$\mathbf{i}_s = -\sigma_s \nabla \phi_s$$

and σ_s denotes the electrode conductivity and ϕ_s the electric potential. The average current density condition imposes the same equation but multiplies the current density by the area of the boundary to obtain the value of the total current, $I_{n, s}$.

If a contact resistance R_c is included, the following current density condition is used:

$$-\mathbf{n} \cdot \mathbf{i}_s = \frac{\phi_{s, \text{bnd}} - \phi_s}{R_c}$$

SYMMETRY THEORY

The [Symmetry](#) boundary condition, in the Primary Current Distribution and Secondary Current Distribution interfaces is identical to the Insulation condition and is expressed according to the equation below.

$$\mathbf{i}_k \cdot \mathbf{n} = 0$$

where \mathbf{i}_k denotes the current density vector and $k = l, s$ is an index for the electrolyte and electrode, respectively.

The Symmetry boundary condition for the Tertiary Current Distribution, Nernst–Planck interface imposes a no-flux condition for the molar flux of species at a boundary. The condition is expressed as follows:

$$\mathbf{J}_i \cdot \mathbf{n} = 0$$

ELECTRODE CURRENT DENSITY THEORY

An applied [Electrode Current Density](#) can be defined as its component perpendicular to the boundary according to:

$$\mathbf{i}_s \cdot \mathbf{n} = i_{n,s}$$

where

$$\mathbf{i}_s = -\sigma_s \nabla \phi_s$$

and σ_s denotes the electrode conductivity and ϕ_s the electric potential.

The current density can also be defined including all its components:

$$\mathbf{i}_s = \mathbf{i}_{s, \text{bnd}}$$

where $\mathbf{i}_{s, \text{bnd}}$ is a given expression for the current density vector.

ELECTRODE POWER THEORY

The Electrode Power boundary condition is used to specify either the total electrode power or the average electrode power density drawn from or inserted into an electrochemical cell at an electrode boundary.

For a total power condition, the boundary electric potential of an electrode is set to a potential $\phi_{s, \text{bnd}}$, defined by the condition for the total power on the boundary $\partial\Omega$ according to:

$$\phi_s = \phi_{s, \text{bnd}} \quad \text{on } \partial\Omega$$

$$\int_{\partial\Omega} (\phi_{s, \text{bnd}} - \phi_{s, \text{ground}})(\mathbf{i}_s \cdot \mathbf{n})dS = P_{\text{total}}$$

where $\phi_{s, \text{ground}}$ is the ground potential of the cell, and P_{total} (W) is the power to be drawn.

If a contact resistance R_c is included, the following current density condition is used:

$$-\mathbf{n} \cdot \mathbf{i}_s = \frac{\phi_{s, \text{bnd}} - \phi_s}{R_c}$$

For an average power condition, P_{total} is calculated by:

$$P_{\text{total}} = P_{\text{avg}}A$$

where P_{avg} is the average power density on the boundary, and A is the boundary area.



For a galvanic cell, such as a battery during discharge or a fuel cell, there is a maximum power level, beyond which a further current increase causes a lowered output power due to increasing voltage losses. A result of this is that there can be two existing solutions for the same power setting. In these cases the choice of initial values determines the final solution.



[Electrode Power](#)

ION EXCHANGE MEMBRANE THEORY

Ion-exchange membranes typically contain a polymer matrix with a number of fixed ionic groups.

Since these charges are fixed, there is no need to explicitly model the transport of these charges, but when calculating the sum of charges, used in the Nernst–Planck (with electroneutrality) or the Nernst–Planck–Poisson set of equations, one need to add this fixed space charge.

For Nernst Planck with electroneutrality, the electroneutrality condition reads

$$\rho_{\text{fix}} + F \sum z_i c_i = 0$$

For the Nernst–Planck–Poisson case, the total space charge density becomes

$$\rho_v = \rho_{\text{fix}} + F \sum z_i c_i$$

ION EXCHANGE MEMBRANE BOUNDARY THEORY

The electrochemical potential μ_i of a charged species of index i is

$$\mu_i = RT \ln a_i + \phi_l z_i F$$

where T (K) is the temperature, R (mol/(J K)) the molar gas constant, a_i is the species activity, ϕ_l is the electrolyte potential, z_i the species charge, and F (C/mol) is Faraday's constant.

At equilibrium the electrochemical potentials on each side of the free electrolyte - ion-exchange membrane interface are equal.

Setting the species activity to equal the concentration and denoting the liquid electrolyte phase and an ion-exchange membrane phases as 1 and 2, respectively, the Donnan potential, $\Delta\phi$ (V), describes the relation between the concentration of a species, c_i (mol/m³), at each side of the boundary and the electrolyte potentials:

$$\Delta\phi_l = \phi_{l,1} - \phi_{l,2} = -\frac{RT}{z_i F} \ln \left(\frac{c_{i,1}}{c_{i,2}} \right)$$

which may be rearranged to

$$c_{i,2} = c_{i,1} \exp \left(-\frac{z_i F (\phi_{l,1} - \phi_{l,2})}{RT} \right)$$

The molar flux of each species in the liquid electrolyte is continuous over the membrane-liquid interface

$$\mathbf{n} \cdot \mathbf{J}_{i,1} = \mathbf{n} \cdot \mathbf{J}_{i,2}$$

Since the total current density is the sum of all species fluxes, times the individual species charges, the current densities \mathbf{I}_l in the normal direction \mathbf{n} of the membrane-liquid interface boundary is also continuous:

$$\mathbf{n} \cdot \mathbf{I}_{l,1} = \mathbf{n} \cdot \mathbf{I}_{l,2}$$

Reference

I. J. O'M. Bockris, A.K.N. Reddy, and M. Gamboa-Aldeco, *Modern Electrochemistry*, vol. 2A, 2nd ed., ch. 7, sec. 7.6, Kluwer Academic/Plenum Press, New York, 2000.

Theory for Electrochemical Heat Sources

Irreversible voltage losses in an electrochemical cell can occur due to the following phenomena:

- Charge transport in the electrolyte (Joule heating)
- Charge transport in the solid conductor materials (Joule heating)
- Activation overpotentials in the electrode reactions
- Heat of mixing

In addition, reversible heat sources and sinks can appear due to the entropy changes in the electrode reactions.

Most Electrochemistry interfaces define and announce heat source variables that can be used by the General Source and the Boundary Heat source nodes in the Heat Transfer interfaces.

An alternative way to couple an electrochemical interface to a heat transfer interface is by the use of the Multiphysics nodes that become available in the model builder tree if there is both a Heat Transfer interface and an Electrochemistry interface available in the same component.

The [Electrochemical Heating](#) multiphysics node defines a domain heat source in the heat transfer interface, based on the sum of irreversible (Joule heating and activation losses) and reversible heat in the electrochemistry interface.

You can also use the heat source variables defined by the electrochemistry interfaces when setting up manual heat couplings between different components in a model. For instance if you are using a 1D electrochemical cell model to calculate an average heat source in a 3D heat transfer model. The names of the heat source variables are `xxx.Qh` (domain, Joule heating and porous electrode reactions) and `xxx.Qbfc` (boundary, electrode surface reactions), where `xxx` is the electrochemistry interface identifier.



- [Electrochemistry Interfaces](#)
 - [Multiphysics Coupling Nodes](#)
-

Joule Heating Due to Charge Transport

As the charged particles are transported in an electric field, electrical energy is converted into heat. The heat source terms for Joule heating in the electrode and electrolyte phases are computed similarly by multiplying the current vector to the gradient of the potential field variable according to

$$Q_{\text{JH}} = -(\mathbf{i}_s \cdot \nabla \phi_s + \mathbf{i}_l \cdot \nabla \phi_l) \quad (4-4)$$

Heating Due to Electrochemical Reactions

For an electrochemical reaction process one can write the total heat balance as:

Heat generated = Total Reaction Energy – Electrical Energy Generated

Using Faraday's law for an electrode reaction, m , at the interface between the electron and ion conducting phase this corresponds to

$$Q_m = \left(\frac{\Delta H_m}{n_m F} - \left(\frac{\Delta G_m}{n_m F} - \eta_{m, \text{tot}} \right) \right) i_m \quad (4-5)$$

where ΔH_m is the enthalpy change of the reaction, and ΔG_m is the Gibbs free energy of the reaction, ΔG_m , defined as

$$\Delta G_m = \Delta H_m - T\Delta S_m$$

where ΔS_m is the net entropy change. Equation 4-5 may now be rearranged into

$$Q_m = \left(\eta_{m, \text{tot}} + \frac{T\Delta S_m}{n_m F} \right) i_m \quad (4-6)$$

where the first term represents the irreversible activation losses, and the second term is the reversible heat change due to the net change of entropy in the conversion process.

In Equation 4-5 we have used the total overpotential, $\eta_{m, \text{tot}}$ (including potential effects from film resistances and similar), defined as

$$\eta_{m, \text{tot}} = \phi_s - \phi_l - E_{\text{eq}, m}$$

The equilibrium potential is related to ΔG_m in the following way:

$$E_{\text{eq}, m} = -\frac{\Delta G_m}{n_m F}$$

By the relation between the temperature derivative of the equilibrium potential and the entropy:

$$\frac{\partial E_{\text{eq}, m}}{\partial T} = \frac{\Delta S_m}{n_m F}$$

the local heat source due to the electrochemical conversion process becomes

$$Q_m = \left(\eta_{m, \text{tot}} + T \frac{\partial E_{\text{eq}, m}}{\partial T} \right) i_m$$

Alternatively, by defining the thermoneutral voltage of the reaction as

$$E_{\text{therm}, m} = -\frac{\Delta H_m}{n_m F}$$

one may also define the heat source as

$$Q_m = (\eta_{m, \text{tot}} + (E_{\text{eq}, m} - E_{\text{therm}, m})) i_m$$

The total heat source due to the electrochemical reactions, Q_{EC} , for an electrode surface is the sum of all individual heat sources of the electrode reactions according to

$$Q_{EC} = \sum_m Q_m$$

For a porous electrode joule heating and electrochemical sources are summed up for a total heat source in the domain according to

$$Q_{\text{TOT}, p} = \sum_m a_{v, m} Q_m + Q_{JH}$$

Heating Due to Heat of Mixing

If the enthalpy varies with the local concentration of the reacting species of the reaction, there are also heat of mixing sources associated with the concentration gradients and resulting molecular flux of the reacting species from the bulk to the surface that have to be included for a correct thermal balance of the cell. The heat of mixing effects are typically small (zero for ideal gases) and are generally not included

in the Electrochemistry interfaces, except for intercalating porous electrodes in the battery interfaces (see next section).

Heat of Mixing in Intercalating Electrodes

For intercalating porous electrodes in the battery interfaces, the heat of mixing $q_{\text{mix},i}$ (W/m^3) of a species of index i is defined as (see Ref. 3)

$$q_{\text{mix},i} = -\mathbf{J}_i \cdot \nabla H_i$$

where \mathbf{J}_i ($\text{mol}/(\text{m}^2\text{s})$) is the molar flux and H_i (J/mol) is the molar enthalpy.

This expression could be seen as a species transport version of Joule heating in an electronic conductor, for which the heat source is defined as the current density multiplied by the gradient of the potential.

Generally, for an intercalation material, two species are considered: the intercalated species, denoted with index s , and the holes, denoted with index θ .

The flux of the two species are equal and opposite.

$$\mathbf{J}_s = -\mathbf{J}_\theta$$

We now define the total heat of mixing as the sum of the contributions from the two species and write

$$q_{\text{mix}} = q_{\text{mix},s} + q_{\text{mix},\theta} = -\mathbf{J}_s \cdot \nabla(H_s - H_\theta)$$

The absolute value of the individual molar enthalpies are generally not known. However, the difference of the gradients of the molar enthalpies are related to the thermoneutral voltage, E_{therm} (V) of the intercalation reaction.

The thermoneutral voltage is defined as

$$E_{\text{therm}} = -\frac{\Delta H}{F} = -\frac{(\Delta G + T\Delta S)}{F} = E_{\text{eq}} - T\frac{dE_{\text{eq}}}{dT}$$

where ΔH is the change of molar enthalpy of the redox reaction.

In the case of lithium intercalation the redox reaction is

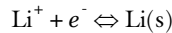

with index $s = \text{Li}(s)$ so that

$$\Delta H = H_{\text{Li(s)}} - H_{\text{Li}^+} - H_{\theta}$$

We now note that, if assuming the equilibrium potential to be independent of the electrolyte lithium ion concentration,

$$\nabla(H_s - H_{\theta}) = -\nabla(FE_{\text{eq, therm}}) = -F \frac{dE_{\text{eq, therm}}}{dc_s} \nabla c_s$$

and finally we get

$$q_{\text{mix}} = -\mathbf{J}_s \cdot \left(-F \frac{dE_{\text{eq, therm}}}{dc_s} \nabla c_s \right)$$

which is added to the expression for $Q_{\text{TOT},p}$ above.

Total Overpotential Calculation for Concentration Dependent Kinetics

When using the Concentration Dependent kinetics option, in the Porous Electrode Reaction and Electrode Reaction nodes, the equilibrium potential is typically a constant referring to a reference state, and the concentration dependence of the kinetics is accounted for only in the pre-exponential terms according to

$$i_{\text{loc},m} = i_{0,m} \left(C_{R,m} \exp\left(\frac{\alpha_{a,m} F \eta_m}{RT}\right) - C_{O,m} \exp\left(\frac{-\alpha_{c,m} F \eta_m}{RT}\right) \right)$$

where

$$\eta_m = \phi_s - \phi_l - E_{\text{eq},m}$$

A result of this is that, when the pre-exponential factors $C_{O,m}$ and $C_{R,m}$ differ due to concentration gradients, we at zero activation overpotential may have a net charge-transfer current density flowing over the electrode-electrolyte interface. This local current density obviously should give rise to a heat source. The solution is to add a concentration overpotential term to the total overpotential when calculating the heat sources.

When using the Concentration Dependent kinetics option, the overpotential, used in the irreversible heat term above, is calculated as follows:

$$\eta_{m,\text{tot}} = \phi_s - \phi_l - E_{\text{eq},m} + \eta_{m,\text{conc}}$$

where

$$\eta_{m, \text{conc}} = \frac{RT}{n_m F} \ln \frac{C_{O, m}}{C_{R, m}}$$

If the number of electrons is not available,

$$n_m = \alpha_{a, m} + \alpha_{c, m}$$

is assumed.

References

1. Bernardi and others, "A General Energy Balance for Battery Systems," *J. Electrochem. Soc.*, vol. 132, pp. 5–12, 1985.
2. Thomas and others, "Thermal Modeling of Porous Insertion Electrodes," *J. Electrochem. Soc.*, vol. 150, pp. A176–A192, 2003.
3. j. Newman and K.E. Thomas-Alyea, *Electrochemical Systems*, Chapter 13 Thermal Effects, Wiley, 2012.

Theory for the Electrode, Shell Interface

The [Electrode, Shell Interface](#) defines electrode current conduction in a thin shell on a boundary. The electrolyte current distribution in the adjacent domain is typically solved for by a separate physics interface.

In this section:

- [Governing Equations](#)
- [Coupling to Other Physics Interfaces](#)

Governing Equations

The Electrode, Shell interface solves for the electric potential ϕ_s (SI unit: V) on a boundary, using the following governing equation:

$$\nabla_{\mathbf{T}} \cdot (s \mathbf{i}_s) = -i_n \quad (4-7)$$

where $\nabla_{\mathbf{T}}$ is the tangential gradient operator, s (SI unit: m) is the electrode layer thickness, and i_n (SI unit: A/m²) are the sum of all currents flowing out from the electrode (in the normal direction to the boundary). Furthermore, \mathbf{i}_s (SI unit: A/m²) is the tangential current density vector along the electrode boundary, defined as

$$\mathbf{i}_s = -\nabla_{\mathbf{T}} \sigma_s \phi_s \quad (4-8)$$

where σ_s is the electric conductivity (SI unit: S/m). The next section discusses [Coupling to Other Physics Interfaces](#).

Coupling to Other Physics Interfaces

ELECTRODE POTENTIAL IN OTHER PHYSICS INTERFACES

Typically the boundary electric potential in the Electrode Surface node is set to the electric potential in the Electrode, Shell interface.

ELECTRODE REACTION CURRENTS

The sum of currents can be coupled to other electrochemistry interfaces, calculating i_n as

$$i_n = i_{\text{tot}}$$

where i_{tot} (SI unit: A/m^2) is the sum of all electrode currents in the coupled Electrochemistry interface.

ELECTRODE LAYER THICKNESS

The electrode thickness, s , can typically be coupled to an External Depositing Electrode (External Corroding Electrode) node in the Electrodeposition, Moving Mesh (Corrosion, Moving Mesh) interface, in that case s is calculated as

$$s = s_0 + \Delta s_{\text{tot}} \quad (4-9)$$

where s_0 is the initial electrode layer thickness, and Δs_{tot} is the electrode thickness change, calculated by the coupled Electrochemistry interface.

HEAT SOURCE

The electron conduction gives rise to a Joule heating source Q_H (SI unit: W/m^2) according to

$$Q_H = -s \mathbf{i}_s \cdot \nabla_t \phi_s$$

Theory for Electroanalysis

The theory related to the **Electroanalysis** charge conservation model in [The Tertiary Current Distribution, Nernst-Planck Interface](#) (tcd) is described in this section:

- [Electroanalytical Methods](#)
- [Supporting Electrolyte](#)
- [Domain Equations for the Electroanalysis Case](#)
- [Electrode Boundary Conditions in the Electroanalysis Model](#)
- [The Electroanalytical Butler–Volmer Equation](#)
- [Counter Electrodes and Overall Charge Balance](#)

Electroanalytical Methods

Electroanalysis is the science of quantitative electrochemical measurement of the composition or properties of a chemical system. Common electroanalytical methods include: (cyclic) voltammetry, (chrono)amperometry, potentiometry, coulometry, and electrochemical impedance spectroscopy (EIS). These methods are experiments performed either in a static electrolyte solution or in an electrolyte solution subject to a forced fluid flow. The results sought in electroanalysis include:

- Measurement of the concentration of an analyte — for example, glucose, or a gas-phase species that dissolves in the electrolyte solution. This technique is often referred to as *electrochemical sensing*. The most common sensing method is by recording the concentration-dependent current due to an analyte-specific reaction: this is called *amperometric sensing*.
- Measurement of the kinetic and/or thermodynamic parameters describing an electrochemical reaction on a given electrode surface.
- Measurement of the transport properties of an electroactive chemical species.
- Investigation of the mechanism of an electrochemical reaction and the further reactivity of the electrochemically generated chemical species.

Supporting Electrolyte

When performing electroanalytical experiments, it is conventional to add a large quantity of inert salt to the solution — this artificially added salt is called *supporting*

electrolyte. The purpose of the supporting electrolyte is to increase the conductivity of the solution, and hence to eliminate the electric field from the electrolyte.

A negligible electric field provides two advantages for electroanalysis:

- The voltage due to the resistance of the electrolyte when the cell draws current (“ohmic drop”) is minimal. Therefore, the potential difference applied across the electrochemical cell is localized at the electrode–electrolyte interfaces, and so the activation overpotential perceived by the redox couple at this interface is almost exactly proportional to the applied cell voltage. The kinetic behavior of the electrochemical cell then has no explicit dependence on the magnitude of the drawn current.
- The contribution of migration to the transport of charged chemical species is negligible compared to the contribution of diffusion (and of convection, in a forced flow). Therefore the transport properties of the system are linearized, and they do not depend on the magnitude of the drawn current.

These properties greatly simplify the design and analysis of electroanalytical experiments. Therefore, the use of a supporting electrolyte is very common in electrochemical sensing and electroanalysis.



The amount of supporting electrolyte required for the assumption of zero electric field to be sound is dependent on the system. Typically it becomes valid when the concentration of inert salt exceeds the concentration of analyte by a factor of 10–100, but this is not always the case.

Even for the conductivities of electrolyte solutions in the presence of excess supporting electrolyte, the electric field is not negligible if significant current density is drawn. Electroanalysis typically draws small currents because the purpose is measurement. In processes where an electrochemical reaction is driven — such as electrolysis, electrodeposition, batteries, and fuel cells — current densities are typically much larger, so that the desired extent of reaction is achieved in a reasonable time. Under these conditions, significant electric fields are likely and other charge conservation models should be used instead of the Electroanalysis option.

Domain Equations for the Electroanalysis Case

The Electroanalysis option assumes that the electric field is zero, and so the electrolyte potential is constant. Since you can arbitrarily choose to ground the electrolyte potential at any point, set it to $\phi_l = 0$.

This is equivalent to the assumption of infinite electrolyte conductivity. Therefore the Electroanalysis option does not solve for charge transfer within domains, because current density is not meaningfully defined within the electrolyte.

The transport of chemical species in an electrolyte solution obeys the Nernst–Planck equation for the flux of species i :

$$\mathbf{N}_i = -D_i \nabla c_i - z_i u_{m,i} F c_i \nabla \phi_l + c_i \mathbf{u} = \mathbf{J}_i + c_i \mathbf{u}$$

Here \mathbf{J}_i denotes the molar flux relative to the convective transport.

At zero electric field, this reduces to:

$$\mathbf{N}_i = -D_i \nabla c_i + c_i \mathbf{u} \quad (4-10)$$

where the only contributions to the flux of a chemical species are from diffusion and convection respectively. In the absence of convection (no fluid flow, $\mathbf{u} = 0$), this is also known as *Fick's first law of diffusion*:

$$\mathbf{N}_i = \mathbf{J}_i = -D_i \nabla c_i$$

A mass balance also applies to each chemical species:

$$\frac{\partial c_i}{\partial t} + \nabla \cdot \mathbf{N}_i = R_{i, \text{tot}} \quad (4-11)$$

The Electroanalysis charge conservation model solves [Equation 4-10](#) and [Equation 4-11](#) for the unknown concentrations of each chemical species under analysis.

This combination is often written as a single equation for the unknown c_i . For zero convection, zero reaction, and a constant diffusion coefficient, the domain equation is:

$$\frac{\partial c_i}{\partial t} = D_i \nabla^2 c_i \quad (4-12)$$

Equation 4-12 is *Fick's second law of diffusion*.



The Electroanalysis charge conservation model is not suitable to explicitly model the transport of the supporting electrolyte, since the migration of the supporting electrolyte is always its dominant mode of mass transport. For a coupled model including the chemical species of all charge-carrying species, use the electroneutrality model in Tertiary Current Distribution, Nernst–Planck interface.



You can also include additional chemical species and reactions that are not involved in the electrochemical reaction.



- [Electrode Potentials and Reference Electrodes](#)
- [The Tertiary Current Distribution, Nernst–Planck Interface](#)

Electrode Boundary Conditions in the Electroanalysis Model

The *activation overpotential* at an electrode–electrolyte interface with respect to the electrode reaction m is defined as:

$$\eta_m = \phi_s - \phi_l - E_{\text{eq},m}$$

This is the potential difference perceived by a redox couple, measured against the equilibrium potential of the couple; it provides the thermodynamic driving force for an electrochemical reaction by faradaic charge transfer between the electrode and the electrolyte domains.

Subject to the approximation of constant electrolyte potential ($\phi_l = 0$), this equation reduces to:

$$\eta_m = \phi_s - E_{\text{eq},m}$$

The activation overpotential is independent of the properties of the adjacent electrolyte. It only depends on the applied electrode potential ϕ_s and the equilibrium potential of the redox couple, where both are measured against a common reference potential.

The current density due to an electrode reaction at a point on an electrode surface is computed using an electrochemical rate expression. For most practical electroanalytical applications, the rate depends on the local concentration which varies during the study, and so the most relevant expression is [The Electroanalytical Butler–Volmer Equation](#).



Electrode Kinetics Expressions

The flux N_i of the chemical species i (SI unit: mol/m²) across an electrode surface depends on the current densities i_m associated with the electrode reactions m according to *Faraday's laws of electrolysis*. These can be written as:

$$N_i = \sum_m \frac{\nu_{i,m} i_m}{n_m F} \quad (4-13)$$

where $\nu_{i,m}$ is the stoichiometric coefficient of species i with respect to reaction m (in the reductive direction), and n_m is the number of transferred electrons. F is the *Faraday constant*, which is the charge on a mole of electrons (96485.3365 C/mol).

The surface flux is applied as a boundary condition:

$$N_i = \mathbf{N}_i \cdot \mathbf{n} \quad (4-14)$$

[Equation 4-13](#) and [Equation 4-14](#) constitute the coupling between charge balance and mass balance. This coupling only applies at the electrode–electrolyte interface, which is a boundary to the domain where the electroanalysis charge conservation model solves for chemical species transport.

The total current density is the sum of faradaic (electrode reaction) components and nonfaradaic components (i_{nf}) such as current due to [Double-Layer Capacitance](#):

$$i_{\text{total}} = \sum_m i_{\text{loc}, m} + i_{\text{nf}}$$

The experimentally measurable total current I (SI unit: A) drawn at an electrode can be computed by integration of the local current density (SI unit: A/m²) across the electrode area:

$$I_{\text{total}} = \int_{\partial\Omega} i_{\text{total}} ds$$



Domain Equations for the Electroanalysis Case

The Electroanalytical Butler–Volmer Equation

A one-electron electrochemical reaction between two solution-phase species can be written as a reduction $\text{Ox} + e^- \leftrightarrow \text{Red}$.

Ox and **Red** represent the oxidized and reduced forms of the chemical species, respectively.

The most general equation to describe the rate of this reaction as it proceeds at an electrode surface is the electroanalytical *Butler–Volmer equation*:

$$i_{\text{loc}} = k_0 F \left(c_{\text{Red}} \exp\left(\frac{\alpha_a F \eta}{RT}\right) - c_{\text{Ox}} \exp\left(\frac{-\alpha_c F \eta}{RT}\right) \right) \quad (4-15)$$

where k_0 is the *heterogeneous rate constant* (SI unit: m/s) and α_c is the (cathodic) transfer coefficient (dimensionless). For a one-electron reduction, the anodic and cathodic transfer coefficients are related as $\alpha_a + \alpha_c = 1$.

When the current is zero, the electroanalytical Butler–Volmer equation can be rearranged to the thermodynamic *Nernst equation* relating the equilibrium concentrations of the reacting species:

$$c_{\text{Red}} = c_{\text{Ox}} \exp\left(\frac{-FE_{\text{eq}}}{RT}\right)$$

Where the flux of the reacting species is negligible compared to the concentration of these species, the concentrations are roughly constant ($c_{\text{Red}} \sim c_{\text{Ox}} \sim c$). This converts [Equation 4-15](#) into the Butler–Volmer equation written in terms of an exchange current density i_0 (SI unit: A/m^2):

$$i_{\text{loc}} = i_0 \left(\exp\left(\frac{\alpha_a F \eta}{RT}\right) - \exp\left(\frac{-\alpha_c F \eta}{RT}\right) \right)$$

The exchange current density i_0 (SI unit: A/m^2) is then related to the heterogeneous rate constant as $i_0 = k_0 F c$.

Counter Electrodes and Overall Charge Balance

The Electroanalysis charge conservation model does not solve explicitly for the electrolyte potential in the domains. This has the implication that an overall charge balance of a modeled cell does not follow naturally as a result of the domain potential equation (as is the case for instance when solving for Ohm's law in the Secondary Current Distribution interface).

In order to model a charge balance of a cell with an arbitrary number of working electrodes and counter electrodes, the solution is to add an extra degree of freedom for the counter electrode potential, $\phi_{s, CE}$, and then solve for this potential to fulfill the following current balance over all electrode surfaces:

$$\phi_{s, CE}: \int_{\text{electrodes}} i_{\text{tot}} dS = 0 \quad (4-16)$$

The counter electrode potential is used in the overpotential, η , in the kinetics expression(s) on the counter electrode.

$$\eta_m = \phi_{s, CE} - E_{\text{eq}, m} \quad (4-17)$$

Note that only one counter electrode potential degree of freedom is added in the model, regardless of the number of counter electrodes that are active.



Electrode Potentials and Reference Electrodes

In all the Electrochemistry branch interfaces, the dependent potential variables are ϕ_s (SI unit: V), the electric potential of the electrode phase (the electron conductor, such as metal), and ϕ_l (SI unit: V), the potential of the electrolyte phase (ion conductor).

Typically the kinetics of the electrochemical reactions are defined using the overpotential, η (SI unit: V), defined as

$$\eta = \phi_s - \phi_l - E_{\text{eq}} \quad (4-18)$$

where E_{eq} (SI unit: V) is the equilibrium potential. If it is to apply for all overpotentials, a general kinetic expression for an electrode reaction must be set up so that the charge-transfer current over the electrolyte-electrode interface is zero for zero overpotential (equilibrium conditions).

An implication of [Equation 4-18](#) is that it is the potential difference, $\phi_s - \phi_l$, that governs the kinetics, not the absolute individual values of ϕ_s and ϕ_l . A global change in the reference for both potentials has no impact on the electrode kinetics. As a result of this, the potentials have to be “boot-strapped” in a model in some way, typically by making an arbitrary choice of electric ground — for example, on an external boundary — in order to ensure that there is a unique solution to the problem.

In this section:

- [Reference Electrodes](#)
- [Boundary Conditions Using Reference Electrode Potentials](#)
- [Nodes for Handling Electrode Potentials and Reference Electrodes](#)

Reference Electrodes

In experimental electrochemistry, it is common to use *reference electrodes* when controlling current or voltage with a potentiostat. Potential differences in the system are recorded with respect to the equilibrium potential of the redox couple at the reference electrode. A good reference electrode is designed so that no net charge transfer takes place at its electrode-electrolyte interface. Then the overpotential of the reference is zero, so:

$$\phi_{s, \text{ref}} = \phi_l + E_{\text{eq, ref}} \quad (4-19)$$

where $\phi_{s, \text{ref}}$ (SI unit: V) is the electric potential of the reference electrode and $E_{\text{eq, ref}}$ (SI unit: V) is the equilibrium potential of the reference electrode reaction.

The electric potentials of the electrodes in the electrochemical cell can then be defined with respect to the reference electrode according to:

$$E_{\text{vs ref}} = \phi_s - \phi_{s, \text{ref}} \quad (4-20)$$

where $E_{\text{vs ref}}$ (SI unit: V) is the electrode potential versus the reference potential.

It is important to realize that the presence of an ideal reference electrode in the system has no impact on the physics; the only purpose of the reference electrode is to define a stable reference point for the potential levels.

Boundary Conditions Using Reference Electrode Potentials

The set of boundary conditions defined in a model of an electrochemical cell needs to ensure that no current flows through the reference electrode. A constraint for the potential on the actual reference electrode is not suitable in general since it can create unwanted local sources or sinks of current.

When modeling the control of an electrochemical cell by a *potentiostat*, which monitors and controls the potential of an electrodes versus a reference electrode, the electric potential conditions should be applied to the boundaries over which the current flows in the cell. One electrode (the counter electrode) is typically grounded, whereas an electric potential condition is set on all other (working) electrode boundaries according to

$$\phi_{s, \text{bnd}} = E_{\text{vs ref}} + \phi_{s, \text{ref}} \quad (4-21)$$

where $\phi_{s, \text{bnd}}$ (SI unit: V) is the applied electric boundary potential on the electrode.

Nodes for Handling Electrode Potentials and Reference Electrodes

The [Reference Electrode](#) node is a point feature applicable to electrolyte domains (in all the Electrochemistry interfaces). It defines a global electric reference potential $\phi_{s, \text{ref}}$ (SI unit: V) according to [Equation 4-19](#). The $\phi_{s, \text{ref}}$ can be used in the Electrode Potential feature for setting the electric potential of an electrode boundary with respect to the reference potential. The variable $E_{\text{vs ref}}$ (SI unit: V), according to [Equation 4-20](#), is also defined in all electrode domains.

The **Electric Reference Potential** node is a point feature applicable to electrode domains (in all the Electrochemistry interfaces). It defines a global electric reference potential $\phi_{s,\text{ref}}$ (SI unit: V) equal to the dependent variable ϕ_s (SI unit: V) in the point. The $\phi_{s,\text{ref}}$ can be used in the Electrode Potential feature for setting the electric potential of an electrode boundary with respect to the reference potential.

Whenever a $\phi_{s,\text{ref}}$ is defined, the variable $E_{\text{vs ref}}$ (SI unit: V), according to [Equation 4-20](#), is also defined in all electrode domains.

The **Electrode Potential** is a boundary condition feature, applicable to external boundaries of electrode domains (in all the Electrochemistry interfaces). It sets a boundary condition for the electric potential with respect to a defined reference potential according to [Equation 4-21](#). Electric potentials defined by the Electric Reference Potential and Reference Electrode point feature can be used as input when specifying the Electrode Potential feature.

An Electrode Potential alternative in the Boundary Condition settings list is also available for the Electrode Surface node.

The variable $E_{\text{vs ref}}$ (SI unit: V), according to [Equation 4-20](#), is also defined on these features.

AC/DC Interfaces

This chapter describes the physics interfaces found under the **AC/DC** branch .

In this chapter:

- [The Electrostatics Interface](#)
- [The Electric Currents Interface](#)
- [The Electrical Circuit Interface](#)
- [Theory for the Electrostatics Interface](#)
- [Theory for the Electric Currents Interface](#)
- [Theory for the Electrical Circuit Interface](#)

See the *COMSOL Multiphysics Reference Manual* for details about [The Magnetic Fields Interface](#) and the [Theory of Magnetic Fields](#).

The Electrostatics Interface

The **Electrostatics (es)** interface (), found under the **AC/DC>Electric Fields and Currents** branch when adding a physics interface, is used to compute the electric field, electric displacement field, and potential distributions in dielectrics under conditions where the electric charge distribution is explicitly prescribed. The formulation is stationary except for when it is used together with other physics interfaces. Eigenfrequency, frequency-domain, small-signal analysis, and time-domain modeling are supported in all space dimensions.

The physics interface solves Gauss' law for the electric field using the scalar electric potential as the dependent variable.

Charge Conservation is the main node, which adds the equation for the electric potential and has a Settings window for defining the constitutive relation for the electric displacement field and its associated properties such as the relative permittivity.

When this physics interface is added, these default nodes are also added to the **Model Builder** — **Charge Conservation, Zero Charge** (the default boundary condition), and **Initial Values**. Then, from the **Physics** toolbar, add other nodes that implement, for example, boundary conditions and space charges. You can also right-click **Electrostatics** to select physics features from the context menu.

Physics-Controlled Mesh

The physics-controlled mesh is controlled from the **Mesh** node's **Settings** window (if the **Sequence type** is **Physics-controlled mesh**). There, in the table in the **Physics-Controlled Mesh** section, find the physics interface in the **Contributor** column and select or clear the check box in the **Use** column on the same table row for enabling (the default) or disabling contributions from the physics interface to the physics-controlled mesh.

Information from the physics, such as the presence of an infinite elements domain or periodic condition, will be used to automatically set up an appropriate meshing sequence.



In the *COMSOL Multiphysics Reference Manual* see the [Physics-Controlled Mesh](#) section for more information about how to define the physics-controlled mesh.

SETTINGS

The **Label** is the default physics interface name.

The **Name** is used primarily as a scope prefix for variables defined by the physics interface. Refer to such physics interface variables in expressions using the pattern `<name>.<variable_name>`. In order to distinguish between variables belonging to different physics interfaces, the `name` string must be unique. Only letters, numbers, and underscores (`_`) are permitted in the **Name** field. The first character must be a letter.

The default **Name** (for the first physics interface in the model) is `es`.

CROSS-SECTION AREA (1D COMPONENTS)

For 1D components, enter a default value for the **Cross-section area** A (SI unit: m^2). The default value of 1 is typically not representative for a thin domain. Instead it describes a unit thickness that makes the 1D equation identical to the equation used for 3D components. See also [Change Cross Section](#).

THICKNESS (2D COMPONENTS)

For 2D components, enter a default value for the **Out-of-plane thickness** d (SI unit: m). The default value of 1 is typically not representative for a thin dielectric medium, for example. Instead it describes a unit thickness that makes the 2D equation identical to the equation used for 3D components. See also [Change Thickness \(Out-of-Plane\)](#).

DEPENDENT VARIABLES

The dependent variable is the **Electric potential** V . You can change its name, which changes both the field name and the variable name. If the new name coincides with the name of another electric potential field in the model, the physics interfaces shares degrees of freedom. The new name must not coincide with the name of a field of another type or with a component name belonging to some other field.

DISCRETIZATION

Select the shape order for the **Electric potential** dependent variable — **Linear**, **Quadratic** (the default), **Cubic**, **Quartic**, or **Quintic**. For more information about the **Discretization**

section, see [Settings for the Discretization Sections](#) in the *COMSOL Multiphysics Reference Manual*.



In the *COMSOL Multiphysics Reference Manual*, see [Table 2-4](#) for links to common sections and [Table 2-5](#) to common feature nodes. You can also search for information: press F1 to open the **Help** window or Ctrl+F1 to open the **Documentation** window.



Electric Sensor: Application Library path **COMSOL_Multiphysics/Electromagnetics/electric_sensor**

Domain, Boundary, Edge, Point, and Pair Nodes for the Electrostatics Interface

The Electrostatics interface has these domain, boundary, edge, point, and pair nodes available.

ABOUT THE BOUNDARY CONDITIONS

The relevant physics interface condition at interfaces between different media is

$$\mathbf{n}_2 \cdot (\mathbf{D}_1 - \mathbf{D}_2) = \rho_s$$

In the absence of surface charges, this condition is fulfilled by the natural boundary condition

$$\mathbf{n} \cdot [(\epsilon_0 \nabla V - \mathbf{P})_1 - (\epsilon_0 \nabla V - \mathbf{P})_2] = -\mathbf{n} \cdot (\mathbf{D}_1 - \mathbf{D}_2) = 0$$

AVAILABLE NODES

These nodes, listed in alphabetical order, are available from the **Physics** ribbon toolbar (Windows users), **Physics** context menu (Mac or Linux users), or right-click to access the context menu (all users). Also see [Table 5-1](#) for a list of interior and exterior boundary conditions, including edge, point, and pair availability.



In general, to add a node, go to the **Physics** toolbar no matter what operating system you are using. Subnodes are available by clicking the parent node and selecting it from the **Attributes** menu.

- Change Cross Section
- Change Thickness (Out-of-Plane)
- Charge Conservation
- Charge Conservation, Piezoelectric^{1,2}
- Conduction Loss (Time-Harmonic)
- Electric Displacement Field
- Electric Potential
- External Surface Charge Accumulation
- Line Charge (on Axis)
- Line Charge (Out-of-Plane)
- Periodic Condition
- Point Charge
- Point Charge (on Axis)
- Space Charge Density
- Surface Charge Density
- Symmetry Plane (for Electric Field)
- Thin Low Permittivity Gap
- Zero Charge (the default boundary condition)

¹This feature is available with the Piezoelectricity multiphysics interface.

²Requires either the Acoustics Module, MEMS Module, or Structural Mechanics Module.

Table 5-1 lists the interior and exterior boundary conditions available with this physics interface. It also includes edge, point, and pair availability.

TABLE 5-1: INTERIOR AND EXTERIOR BOUNDARY CONDITIONS (INCLUDING EDGE, POINT, AND PAIR AVAILABILITY) FOR THE ELECTROSTATICS INTERFACE.

NODE	INTERIOR	EXTERIOR	ALSO AVAILABLE FOR
Change Cross Section	x	x	pairs
Change Thickness (Out-of-Plane)	x	x	pairs
Electric Displacement Field	x	x	pairs
Electric Potential	x	x	edges, points, and pairs
External Surface Charge Accumulation		x	pairs
Ground	x	x	edges, points, and pairs
Periodic Condition		x	not applicable
Surface Charge Density	x	x	pairs
Symmetry Plane		x	not applicable
Thin Low Permittivity Gap	x		not applicable
Zero Charge (the default)	x	x	pairs



For axisymmetric components, COMSOL Multiphysics takes the axial symmetry boundaries (at $r = 0$) into account and automatically adds an **Axial Symmetry** node to the model that is valid on the axial symmetry boundaries only. There are also **Line Charge (on Axis)** and **Point Charge (on Axis)** available.



In the *COMSOL Multiphysics Reference Manual*, see [Table 2-4](#) for links to common sections and [Table 2-5](#) to common feature nodes. You can also search for information: press F1 to open the **Help** window or Ctrl+F1 to open the **Documentation** window.

Charge Conservation

The **Charge Conservation** node adds the equations for charge conservation according to Gauss' law for the electric displacement field. It provides an interface for defining the constitutive relation and its associated properties such as the relative permittivity.

MATERIAL TYPE

The **Material type** setting decides how materials behave and how material properties are interpreted when the mesh is deformed. Select **Solid** for materials whose properties change as functions of material strain, material orientation, and other variables evaluated in a material reference configuration (material frame). Select **Nonsolid** for materials whose properties are defined only as functions of the current local state at each point in the spatial frame, and for which no unique material reference configuration can be defined. Select **From material** to pick up the corresponding setting from the domain material on each domain.

CONSTITUTIVE RELATION D-E

Select a **Dielectric model** to describe the macroscopic properties of the medium (relating the electric displacement \mathbf{D} with the electric field \mathbf{E}) and the applicable material properties, such as the relative permittivity. Select:

- **Relative permittivity** (the default) to use the constitutive relation $\mathbf{D} = \epsilon_0 \epsilon_r \mathbf{E}$. Then the default is to take the **Relative permittivity** ϵ_r (dimensionless) values **From material**. For **User defined**, select **Isotropic**, **Diagonal**, **Symmetric**, or **Full** and enter values or expressions in the field or matrix. The default is 1.
- **Polarization** to use the constitutive relation $\mathbf{D} = \epsilon_0 \mathbf{E} + \mathbf{P}$. Then enter the components based on space dimension for the **Polarization** vector \mathbf{P} (SI unit: C/m²). The defaults are 0 C/m².
- **Remanent electric displacement** to use constitutive relation $\mathbf{D} = \epsilon_0 \epsilon_r \mathbf{E} + \mathbf{D}_r$, where \mathbf{D}_r is the remanent displacement (the displacement when no electric field is present). Then the default is to take the **Relative permittivity** ϵ_r (dimensionless) values **From material**. For **User defined**, select **Isotropic**, **Diagonal**, **Symmetric**, or **Full** and enter values or expressions in the field or matrix. Then enter the components based on space dimension for the **Remanent electric displacement** \mathbf{D}_r (SI unit: C/m²). The defaults are 0 C/m².

Conduction Loss (Time-Harmonic)



This feature requires either the Acoustics Module, or MEMS Module, or Structural Mechanics Module. See the individual documentation for information.

The **Conduction Loss (Time-Harmonic)** subnode to **Charge Conservation** allows you to model possible conductive losses in a dielectric material. The effect is only active in an Eigenfrequency or Frequency Domain study.

CONDUCTION CURRENT

By default, the **Electrical conductivity** σ for the media is defined **From material**. You can also select **User defined** or **Linearized resistivity**.

- For **User defined** select **Isotropic**, **Diagonal**, **Symmetric**, or **Full** depending on the characteristics of the electrical conductivity, and then enter values or expressions for the **Electrical conductivity** σ in the field or matrix.
- For **Linearized resistivity** the default **Reference temperature** T_{ref} , and **Resistivity temperature coefficient** α , and **Reference resistivity** ρ_0 are taken **From material**, which means that the values are taken from the domain (or boundary) material. T is the current temperature, which can be a value that is specified as a model input or the temperature from a heat transfer interface. The definition of the temperature field appears in the **Model Inputs** section.

LOCATION IN USER INTERFACE

Context Menus

Electrostatics>Charge Conservation>Conduction Loss (Time-Harmonic)

Ribbon

Physics tab with **Charge Conservation** node selected in the model tree:

Attributes>Conduction Loss (Time-Harmonic)

Initial Values

The **Initial Values** node adds an initial value for the electric potential V that can serve as an initial condition for a transient simulation or as an initial guess for a nonlinear solver.

INITIAL VALUES

Enter a value or expression for the initial value of the **Electric potential** V (SI unit: V). The default value is 0 V.

Space Charge Density

The **Space Charge Density** node adds a space charge density ρ , which appears on the right-hand side of the equation that the physics interface defines.

SPACE CHARGE DENSITY

Enter a value or expression for the **Space charge density** ρ_v (SI unit: C/m³). The default is 0 C/m³.

Zero Charge

The **Zero Charge** node adds the condition that there is zero charge on the boundary so that $\mathbf{n} \cdot \mathbf{D} = 0$. This boundary condition is also applicable at symmetry boundaries where the potential is known to be symmetric with respect to the boundary. This is the default boundary condition at exterior boundaries. At interior boundaries, it means that no displacement field can penetrate the boundary and that the electric potential is discontinuous across the boundary.

Ground

The **Ground** node implements ground (zero potential) as the boundary condition $V = 0$.

Ground means that there is a zero potential on the boundary. This boundary condition is also applicable at symmetry boundaries where the potential is known to be antisymmetric with respect to the boundary.

For some physics interfaces, also select additional **Ground** nodes from the **Edges** (3D components) or **Points** (2D and 3D components) submenus. For 2D axisymmetric components, it can be applied on the Symmetry axis.

BOUNDARY, EDGE, OR POINT SELECTION



Beware that constraining the potential on edges or points in 3D or on points in 2D usually yields a current outflow that is mesh dependent.

CONSTRAINT SETTINGS

To display this section, click the **Show More Options** button () and select **Advanced Physics Options** in the **Show More Options** dialog box.

Electric Potential

The **Electric Potential** node provides an electric potential V_0 as the boundary condition $V = V_0$.

Because the electric potential is being solved for in the physics interface, the value of the potential is typically defined at some part of the geometry. For some physics interfaces, also select additional **Electric Potential** nodes from the **Edges** (3D components) or **Points** (2D and 3D components) submenus. For 2D axisymmetric components, it can be applied on the symmetry axis.

BOUNDARY, EDGE, OR POINT SELECTION



Beware that constraining the potential on edges or points in 3D or on points in 2D usually yields a current outflow that is mesh dependent.

ELECTRIC POTENTIAL

Enter the value or expression for the **Electric potential** V_0 (SI unit: V). The default is 0 V.

CONSTRAINT SETTINGS

To display this section, click the **Show More Options** button () and select **Advanced Physics Options** in the **Show More Options** dialog box.

Surface Charge Density

The **Surface Charge Density** node provides the following surface-charge boundary condition for exterior boundaries (left) and interior boundaries (right):

$$-\mathbf{n} \cdot \mathbf{D} = \rho_s, \quad \mathbf{n} \cdot (\mathbf{D}_1 - \mathbf{D}_2) = \rho_s$$

Specify the surface charge density ρ_s at an outer boundary or at an interior boundary between two nonconducting media.

Add a contribution as a **Harmonic Perturbation** by right-clicking the parent node or click **Harmonic Perturbation** in the **Physics** toolbar. For more information, see [Harmonic Perturbation — Exclusive and Contributing Nodes](#).

SURFACE CHARGE DENSITY

Enter the value or expression for the **Surface charge density** ρ_s (SI unit: C/m²).

External Surface Charge Accumulation

The **External Surface Charge Accumulation** node implements the boundary condition

$$-\mathbf{n} \cdot \mathbf{D} = \rho_s$$

where ρ_s is the solution of the following distributed ODE on the boundary:

$$\frac{d\rho_s}{dt} = \mathbf{n} \cdot \mathbf{J}_i + \mathbf{n} \cdot \mathbf{J}_e$$

where $\mathbf{n} \cdot \mathbf{J}_i$ is the normal component of the total ion current density on the wall and $\mathbf{n} \cdot \mathbf{J}_e$ is the normal component of the total electron current density on the wall, which are feature inputs.

MATERIAL TYPE

The **Material type** setting decides how materials behave and how material properties are interpreted when the mesh is deformed. Select **Solid** for materials whose properties change as functions of material strain, material orientation, and other variables evaluated in a material reference configuration (material frame). Select **Nonsolid** for materials whose properties are defined only as functions of the current local state at each point in the spatial frame, and for which no unique material reference configuration can be defined. Select **From material** to pick up the corresponding setting from the domain material on each domain.

EXTERNAL SURFACE CHARGE ACCUMULATION

Enter values or expressions for the **Normal ion current density** $\mathbf{n} \cdot \mathbf{J}_i$ (SI unit: A/m²) and the **Normal electron current density** $\mathbf{n} \cdot \mathbf{J}_e$ (SI unit: A/m²).

Symmetry Plane (for Electric Field)

The **Symmetry Plane** node adds a boundary condition that represents symmetry or antisymmetry in the electric field, depending on which option is chosen.

SYMMETRY TYPE

Choose between **Symmetry** and **Antisymmetry** for the electric field. If **Symmetry** is chosen, the boundary condition is

$$\mathbf{n} \cdot \mathbf{E} = 0$$

which states that the normal component of the electric field is zero. If **Antisymmetry** is chosen, the boundary condition becomes

$$\mathbf{n} \times \mathbf{E} = 0$$

which states that the tangential component of the electric field is zero.

Electric Displacement Field

The **Electric Displacement Field** node adds the following electric-displacement boundary condition:

$$\mathbf{n} \cdot \mathbf{D} = \mathbf{n} \cdot \mathbf{D}_0$$

It specifies the normal component of the electric displacement field at a boundary.

ELECTRIC DISPLACEMENT FIELD

Enter the coordinates of the **Boundary electric displacement field \mathbf{D}_0** (SI unit: C/m²).

Periodic Condition

The **Periodic Condition** node defines periodicity or antiperiodicity between two boundaries. If required, activate periodic conditions on more than two boundaries, in which case the Periodic Condition tries to identify two separate surfaces that can each consist of several connected boundaries. For more complex geometries, it might be necessary to use the **Destination Selection** section, which you activate by right-clicking the **Periodic Condition** node and select **Manual Destination Selection**. With that section, the boundaries which constitute the source and destination surfaces can be manually specified.



When this feature is used in conjunction with a feature on connected boundaries, wherever the sector symmetry boundaries connect with the periodic boundaries, the same periodic condition feature cannot be used on both sides. At least two periodic condition features are required for the model to compute correctly.

BOUNDARY SELECTION



The software usually automatically identifies the boundaries as either source boundaries or destination boundaries, as indicated in the selection list. This works fine for cases like opposing parallel boundaries. In other cases, right-click **Periodic Condition** and select **Manual Destination Selection** to control the destination. By default it contains the selection that COMSOL Multiphysics identifies.

When using nonconforming meshes on the source and destination of a periodic boundary pair, for numerical stability, a finer mesh should be applied on the destination side. Use conforming meshes if possible.

DESTINATION SELECTION

This section is available for specifying the destination boundaries, if needed, when the **Manual Destination Selection** option is selected in the context menu for the **Periodic Condition** node. You can only select destination boundaries from the union of all source and destination boundaries.

PERIODIC CONDITION

Select a **Type of periodicity** — **Continuity** (the default), **Antiperiodicity**, or **Floquet periodicity**. Select:

- **Continuity** to make the potential periodic (equal on the source and destination).
- **Antiperiodicity** to make it antiperiodic.
- **Floquet periodicity** (only available with products supporting piezoelectric modeling). Specify the components of the **k-vector for Floquet periodicity** \mathbf{k}_F (SI unit: rad/m).

CONSTRAINT SETTINGS

To display this section, click the **Show More Options** button () and select **Advanced Physics Options** in the **Show More Options** dialog box.

ORIENTATION OF SOURCE

To display this section, click the **Show More Options** button () and select **Advanced Physics Options** in the **Show More Options** dialog box. For information about the **Orientation of Source** section, see [Orientation of Source and Destination](#).

ORIENTATION OF DESTINATION

This section appears if the setting for **Transform to intermediate map** in the **Orientation of Source** section is changed from the default value, **Automatic**, and **Advanced Physics**

Options is selected in the **Show More Options** dialog box. For information about the **Orientation of Destination** section, see [Orientation of Source and Destination](#).

Thin Low Permittivity Gap

Use the **Thin Low Permittivity Gap** node

$$\mathbf{n} \cdot \mathbf{D}_1 = \frac{\epsilon_0 \epsilon_r}{d} (V_1 - V_2)$$

$$\mathbf{n} \cdot \mathbf{D}_2 = \frac{\epsilon_0 \epsilon_r}{d} (V_2 - V_1)$$

to model a thin gap of a material with a small permittivity compared to the adjacent domains. The layer has the thickness d and the relative permittivity ϵ_r . The indices 1 and 2 refer to the two sides of the boundary.

THIN LOW PERMITTIVITY GAP

The default is to take the **Relative permittivity** ϵ_r (dimensionless) values **From material**. For **User defined**, enter a different value or expression. Enter a **Thickness** d (SI unit: m). The default is 5 mm.

Line Charge

For 3D components, use the **Line Charge** node to specify line charges along the edges of a geometry. Add a contribution as a **Harmonic Perturbation** by right-clicking the parent node or clicking **Harmonic Perturbation** in the **Physics** toolbar. For more information see [Harmonic Perturbation — Exclusive and Contributing Nodes](#).

EDGE SELECTION



Beware that constraining the potential on edges usually yields a current outflow that is mesh dependent.

LINE CHARGE

Enter a value or expression to apply a **Line charge** Q_L (SI unit: C/m). This source represents electric charge per unit length and the default is 0 C/m.



Line Charge (on Axis) and Line Charge (Out-of-Plane)

Line Charge (on Axis)

For 2D axisymmetric components, use the **Line Charge (on Axis)** node to specify line charges along the symmetry axis.

Add a contribution as a **Harmonic Perturbation** by right-clicking the parent node or click **Harmonic Perturbation** in the **Physics** toolbar. For more information see [Harmonic Perturbation — Exclusive and Contributing Nodes](#).

LINE CHARGE (ON AXIS)

Enter a value or expression to apply a **Line charge** Q_L (SI unit: C/m). This source represents electric charge per unit length and the default is 0 C/m.



Line Charge and Line Charge (Out-of-Plane)

Line Charge (Out-of-Plane)

For 2D and 2D axisymmetric components, points are selected and this is the same as a line out-of-plane.

Add a contribution as a **Harmonic Perturbation** by right-clicking the parent node or clicking **Harmonic Perturbation** in the **Physics** toolbar. For more information see [Harmonic Perturbation — Exclusive and Contributing Nodes](#).

Use the **Line Charge (Out-of-Plane)** node to specify line charges along the points of a geometry for 2D and 2D axisymmetric components.

POINT SELECTION



Beware that constraining the potential on points usually yields a current outflow that is mesh dependent.

LINE CHARGE (OUT-OF-PLANE)

Enter a value or expression to apply a **Line charge** Q_L (SI unit: C/m). This source represents electric charge per unit length and the default is 0 C/m.



[Line Charge and Line Charge \(on Axis\)](#)

Point Charge

The **Point Charge** node adds a point source to 3D components. The point charge represents an electric displacement field flowing out of the point.

Add a contribution as a **Harmonic Perturbation** by right-clicking the parent node or clicking **Harmonic Perturbation** in the **Physics** toolbar. For more information see [Harmonic Perturbation — Exclusive and Contributing Nodes](#).

POINT SELECTION



Beware that constraining the potential on points usually yields a current outflow that is mesh dependent.

POINT CHARGE

Enter a value or expression to apply a **Point charge** Q_P (SI unit: C) to points. This source represents an electric displacement field flowing out of the point. The default is 0 C.



[Point Charge \(on Axis\) and Line Charge \(Out-of-Plane\)](#)

Point Charge (on Axis)

The **Point Charge (on Axis)** node adds a point source to 2D axisymmetric components. The point charge represents an electric displacement field flowing out of the point.

Add a contribution as a **Harmonic Perturbation** by right-clicking the parent node or clicking **Harmonic Perturbation** in the **Physics** toolbar. For more information see [Harmonic Perturbation — Exclusive and Contributing Nodes](#).

POINT SELECTION



Beware that constraining the potential on points usually yields a current outflow that is mesh dependent.

POINT CHARGE (ON AXIS)

Enter a value or expression to apply a **Point charge** Q_P (SI unit: C) to points on an axis. This source represents an electric displacement field flowing out of the point. The default is 0 C.



[Point Charge and Line Charge \(Out-of-Plane\)](#)

Change Cross Section

This node is available with 1D components. This setting overrides the global **Cross-Section Area** setting made in any physics interface that uses this feature. For 2D components, see [Change Thickness \(Out-of-Plane\)](#).

Use the **Change Cross Section** node to set the cross-section area for specific geometric entities.

CHANGE CROSS SECTION

Enter a value or expression for the **Cross-section area** A . The default value of one unit area is typically not representative for the actual domain. Instead, it describes a unit area that makes the 1D equation identical to the equation used for 3D components.

Change Thickness (Out-of-Plane)

This node is available for 2D components. This setting overrides the global **Thickness** setting made in any physics interface that uses this node. For 1D components, see [Change Cross Section](#).

Use the **Change Thickness (Out-of-Plane)** node to set the out-of-plane thickness for specific geometric entities.

CHANGE THICKNESS (OUT-OF-PLANE)

Enter a value or expression for the **Out-of-plane thickness** d (SI unit: m). The default value is, in most cases, 1 unit length, which is typically not representative for a thin domain. Instead it describes a unit thickness that makes the 2D equation identical to the equation used for 3D components.

Charge Conservation, Piezoelectric



This feature is available with the Piezoelectricity interface, which requires either the Acoustics Module, or MEMS Module, or Structural Mechanics Module. See the individual documentation for information.

The **Charge Conservation, Piezoelectric** node is normally used together with a **Piezoelectric Effect** multiphysics coupling node and a corresponding **Piezoelectric Material** node in the **Solid Mechanics** interface. The node is added by default to the **Electrostatics** interface when adding a Piezoelectricity interface. It is also available from the context menu (right-click the **Electrostatics** interface parent node) or from the **Physics** toolbar.



When the **Charge Conservation, Piezoelectric** node is added to the electrostatics interface in the absence of an active **Piezoelectric Effect** multiphysics coupling node, the material behaves similarly to a [Charge Conservation](#) node, with electric properties corresponding to the relative permittivity entered (see below). The piezoelectric effect is *not* included in the corresponding equation system.

ELECTRIC DISPLACEMENT

If the node is used together with an active **Piezoelectric Effect** multiphysics coupling node, then these settings are locked. Note that if they are unlocked, then the material

behaves like a dielectric and *not* a piezoelectric. In this case, the default is to take the **Relative permittivity** ϵ_{TS} (dimensionless) values **From material**. For **User defined**, select **Isotropic**, **Diagonal**, **Symmetric**, or **Full** and enter values or expressions in the field or matrix.

The Electric Currents Interface

The **Electric Currents (ec)** interface (), under the **AC/DC>Electric Fields and Currents** branch when adding a physics interface, is used to compute electric field, current, and potential distributions in conducting media under conditions where inductive effects are negligible; that is, when the skin depth is much larger than the studied device.

Depending on the licensed products, stationary, frequency-domain, small-signal analysis, and time-domain modeling are supported in all space dimensions. In the time and frequency domains, capacitive effects are also accounted for.

The physics interface solves a current conservation equation based on Ohm's law using the scalar electric potential as the dependent variable. The interface is typically used to model good conductors for which Ohm's law applies. It is not suitable for modeling poor conductors like air and insulators.

Current Conservation is the main node, which adds the equation for the electric potential and provides a Settings window for defining the electrical conductivity as well as the constitutive relation for the electric displacement field and its associated material properties, such as the relative permittivity.

When this physics interface is added, these default nodes are also added to the **Model Builder** — **Current Conservation**, **Electric Insulation** (the default boundary condition), and **Initial Values**. Then, from the **Physics** toolbar, add other nodes that implement, for example, boundary conditions and current sources. You can also right-click **Electric Currents** to select physics features from the context menu.

Physics-Controlled Mesh

The physics-controlled mesh is controlled from the **Mesh** node's **Settings** window (if the **Sequence type** is **Physics-controlled mesh**). There, in the table in the **Physics-Controlled Mesh** section, find the physics interface in the **Contributor** column and select or clear the check box in the **Use** column on the same table row for enabling (the default) or disabling contributions from the physics interface to the physics-controlled mesh.

Information from the physics, such as the presence of an infinite elements domain or periodic condition, will be used to automatically set up an appropriate meshing sequence.



In the *COMSOL Multiphysics Reference Manual* see the [Physics-Controlled Mesh](#) section for more information about how to define the physics-controlled mesh.

SETTINGS

The **Label** is the default physics interface name.

The **Name** is used primarily as a scope prefix for variables defined by the physics interface. Refer to such physics interface variables in expressions using the pattern `<name>.<variable_name>`. In order to distinguish between variables belonging to different physics interfaces, the `name` string must be unique. Only letters, numbers, and underscores (`_`) are permitted in the **Name** field. The first character must be a letter.

The default **Name** (for the first physics interface in the model) is `ec`.

CROSS-SECTION AREA (1D)

Enter a default value for the **Cross-section area** A (SI unit: m^2). The default value of 1 m^2 is typically not representative for a small domain. Instead it describes a unit area that makes the 1D equation identical to the equation used for 3D components. See also (described for the Electrostatics interface).

THICKNESS (2D)

Enter a default value for the **Out-of-plane thickness** d (SI unit: m) (see). The default value of 1 m is typically not representative for a thin dielectric medium, for example. Instead it describes a unit thickness that makes the 2D equation identical to the equation used for 3D components. See also (described for the Electrostatics interface).

DEPENDENT VARIABLES

The dependent variable is the **Electric potential** V . You can change its name, which changes both the field name and the variable name. If the new name coincides with the name of another electric potential field in the model, the physics interfaces share degrees of freedom. The new name must not coincide with the name of a field of another type or with a component name belonging to some other field.

DISCRETIZATION

Select the shape order for the **Electric potential** dependent variable — **Linear**, **Quadratic** (the default), **Cubic**, **Quartic**, or **Quintic**. For more information about the **Discretization** section, see [Settings for the Discretization Sections](#) in the *COMSOL Multiphysics Reference Manual*.



- [Domain, Boundary, Edge, Point, and Pair Nodes for the Electric Currents Interface](#)



Pacemaker Electrode: Application Library path **COMSOL_Multiphysics/Electromagnetics/pacemaker_electrode**

Domain, Boundary, Edge, Point, and Pair Nodes for the Electric Currents Interface

The Electric Currents interface has these domain, boundary, edge, point, and pair nodes available from the **Physics** ribbon toolbar (Windows users) or **Physics** context menu (Mac or Linux users). You can also right-click to access the context menu (all users).



In general, to add a node, go to the **Physics** toolbar, no matter what operating system you are using. Subnodes are available by clicking the parent node and selecting it from the **Attributes** menu.

ABOUT THE BOUNDARY CONDITIONS

The exterior and interior boundary conditions listed in [Table 5-1](#) are available. The relevant physics interface condition at interfaces between different media and interior boundaries is continuity; that is,

$$\mathbf{n}_2 \cdot (\mathbf{J}_1 - \mathbf{J}_2) = 0$$

which is the natural boundary condition.

AVAILABLE NODES

These nodes are available for this physics interface, listed in alphabetical order. Also see [Table 5-1](#) for a list of interior and exterior boundary conditions, including edge, point, and pair availability.

- [Boundary Current Source](#)
- [Contact Impedance](#)
- [Current Conservation](#)
- [Current Source](#)
- [Distributed Impedance](#)
- [Electric Insulation](#)
- [Initial Values](#)
- [Line Current Source](#)
- [Line Current Source \(on Axis\)](#)
- [Normal Current DensityPoint Current Source](#)
- [Sector Symmetry](#)
- [Symmetry Plane \(for Electric Field\)](#)

These nodes are described for the Electrostatics interface:

- [Change Cross Section](#)
- [Change Thickness \(Out-of-Plane\)](#)
- [Electric Potential](#)
- [Ground](#)
- [Periodic Condition](#)



In the *COMSOL Multiphysics Reference Manual*, see [Table 2-4](#) for links to common sections and [Table 2-5](#) for common feature nodes. You can also search for information: press F1 to open the **Help** window or Ctrl+F1 to open the **Documentation** window.



For axisymmetric components, COMSOL Multiphysics takes the axial symmetry boundaries (at $r = 0$) into account and automatically adds an **Axial Symmetry** node to the model that is valid on the axial symmetry boundaries only.

Table 5-1 lists the interior and exterior boundary conditions available with this physics interface. It also includes edge, point, and pair availability.

TABLE 5-2: INTERIOR AND EXTERIOR BOUNDARY CONDITIONS (INCLUDING EDGE, POINT, AND PAIR AVAILABILITY) FOR THE ELECTRIC CURRENTS INTERFACE.

NODE	INTERIOR	EXTERIOR	ALSO AVAILABLE FOR
Boundary Current Source	x		pairs
Contact Impedance	x		pairs
Distributed Impedance	x	x	not applicable
Electric Insulation	x	x	pairs
Electric Potential	x	x	edges, points, and pairs
Ground	x	x	edges, points, and pairs
Normal Current Density		x	not applicable
Periodic Condition		x	not applicable
Symmetry Plane		x	not applicable

Current Conservation

The **Current Conservation** node adds the continuity equation for the electrical potential and provides an interface for defining the electric conductivity as well as the constitutive relation and the relative permittivity for the displacement current.

MATERIAL TYPE

The **Material type** setting decides how materials behave and how material properties are interpreted when the mesh is deformed. Select **Solid** for materials whose properties change as functions of material strain, material orientation, and other variables evaluated in a material reference configuration (material frame). Select **Nonsolid** for materials whose properties are defined only as functions of the current local state at each point in the spatial frame, and for which no unique material reference configuration can be defined. Select **From material** to pick up the corresponding setting from the domain material on each domain.

CONSTITUTIVE RELATION JC-E

By default, the **Electrical conductivity** σ (SI unit: S/m) for the media is defined **From material**. Or select **User defined** or **Linearized resistivity**.

User Defined

For **User defined** select **Isotropic**, **Diagonal**, **Symmetric**, or **Full** depending on the characteristics of the electrical conductivity, and then enter values or expressions for the

electrical conductivity σ in the field or matrix. The default is 0 S/m. If type of temperature dependence is used other than a linear temperature relation, enter any expression for the conductivity as a function of temperature.

Linearized Resistivity

Select **Linearized resistivity** for a temperature-dependent conductivity (this occurs in, for example, Joule heating, and is also called resistive heating). The equation describing the conductivity:

$$\sigma = \frac{1}{\rho_0(1 + \alpha(T - T_{\text{ref}}))}$$

where ρ_0 is the resistivity at the reference temperature T_{ref} , and α is the temperature coefficient of resistance, which describes how the resistivity varies with temperature.

The default **Reference resistivity** ρ_0 (SI unit: $\Omega\cdot\text{m}$), **Reference temperature** T_{ref} (SI unit: K), and **Resistivity temperature coefficient** α (SI unit: 1/K) are taken **From material**, which means that the values are taken from the domain (or boundary) material. T is the current temperature, which can be a value that is specified as a model input or the temperature from a heat transfer interface. The definition of the temperature field is in the **Model Inputs** section.

To specify other values for any of these properties, select **User defined** from the list and then enter a value or expression for each. The default values are:

- 1 $\Omega\cdot\text{m}$ for the Reference resistivity
- 273.15 K for the Reference temperature, and
- 0 1/K for the Resistivity temperature coefficient

CONSTITUTIVE RELATION D-E

Select a **Dielectric model** to describe the macroscopic properties of the medium (relating the electric displacement \mathbf{D} with the electric field \mathbf{E}) and the applicable material properties, such as the relative permittivity. For a description of the constitutive relations **Relative permittivity**, **Polarization**, see **Constitutive Relation D-E** as described for the node for the Electrostatics interface. The constitutive relations specific to Electric Currents are:

- **Loss tangent, loss angle:** uses the constitutive relation $\mathbf{D} = \epsilon_0 \epsilon' (1 - j \tan \delta) \mathbf{E}$. Specify the **Relative permittivity (real part)** ϵ' (dimensionless) and **Loss angle** δ (SI unit: rad).
- **Loss tangent, dissipation factor:** uses the constitutive relation $\mathbf{D} = \epsilon_0 \epsilon' (1 - j \tan \delta) \mathbf{E}$. Specify the **Relative permittivity (real part)** ϵ' (dimensionless) and the **Dissipation factor** $\tan \delta$ (dimensionless).

Initial Values

The **Initial Values** node adds an initial value for the electric potential that can serve as an initial condition for a transient simulation or as an initial guess for a nonlinear solver. If more than one set of initial values is required, from the **Physics** toolbar, add other nodes that implement, for example, boundary conditions and current sources. Add more **Initial Values** nodes from the **Physics** toolbar.

INITIAL VALUES

Enter a value or expression for the initial value of the **Electric potential** V (SI unit: V). The default value is 0 V.

External Current Density

The **External Current Density** node adds an externally generated current density \mathbf{J}_e , which appears in Ohm's law

$$\mathbf{J} = \sigma \mathbf{E} + \mathbf{J}_e$$

and in the equation that the physics interface defines.

The external current density does not contribute to the losses (due to Joule heating), since there is no electric field associated with it. To include the contribution to the losses from the external current density, select the **Add contribution of the external current density to the losses** check box. Then select an option from the **External losses** list — **From domain conductivity** (the default) or **User defined**. If **From domain conductivity** is selected, the heat source is computed using the conductivity specified in the material model feature (such as **Current Conservation**) that is applied in the domain. For **User defined**, enter a value for Q_e (SI unit: W/m^3) to specify a user-defined heat source.

Add a contribution as a **Harmonic Perturbation** by right-clicking the parent node or clicking **Harmonic Perturbation** in the **Physics** toolbar. For more information see [Harmonic Perturbation — Exclusive and Contributing Nodes](#).

EXTERNAL CURRENT DENSITY

Based on space dimension, enter the coordinates (**x**, **y**, and **z** for 3D components, for example) of the **External current density** \mathbf{J}_e (SI unit: A/m²). The defaults are 0 A/m².

Current Source

The **Current Source** node adds a distributed current source Q_j in the equation that the physics interface defines. Use this node with caution as it can violate the current conservation law that is inherent in Maxwell–Ampère’s law.

Add a contribution as a **Harmonic Perturbation** by right-clicking the parent node or clicking **Harmonic Perturbation** in the **Physics** toolbar. For more information see [Harmonic Perturbation — Exclusive and Contributing Nodes](#).

CURRENT SOURCE

Enter a value or expression for the **Current source** Q_j (SI unit: A/m³). The default is 0 A/m³.

Electric Insulation

The **Electric Insulation** node, which is the default boundary condition, adds electric insulation as the boundary condition:

$$\mathbf{n} \cdot \mathbf{J} = 0$$

This boundary condition means that no electric current flows into the boundary. At interior boundaries, it means that no current can flow through the boundary and that the electric potential is discontinuous across the boundary. It is also applicable at symmetric boundaries where the potential is known to be symmetric with respect to the boundary.

Electric insulation as the default boundary condition is not applicable to interior boundaries. To add electric insulation to an interior boundary, add an **Electric Insulation** node in addition to the one that represents the default boundary condition.

Boundary Current Source

The **Boundary Current Source** node adds a current source Q_j on the boundary.

$$\mathbf{n} \cdot (\mathbf{J}_1 - \mathbf{J}_2) = Q_j$$

It is applicable to interior boundaries that represent either a source or a sink of current. Add a contribution as a **Harmonic Perturbation** by right-clicking the parent node or click **Harmonic Perturbation** in the **Physics** toolbar. For more information see [Harmonic Perturbation — Exclusive and Contributing Nodes](#).

BOUNDARY CURRENT SOURCE

Enter a value or expression for the **Boundary current source** Q_j (SI unit: A/m^2). The default is $0 A/m^2$.

Normal Current Density

The **Normal Current Density** node is applicable to exterior boundaries that represent either a source or a sink of current. It provides a condition for specifying the normal current density as an inward or outward current flow:

$$-\mathbf{n} \cdot \mathbf{J} = J_n$$

Or alternatively, as a current density \mathbf{J}_0 :

$$\mathbf{n} \cdot \mathbf{J} = \mathbf{n} \cdot \mathbf{J}_0$$

The normal current density is positive when the current flows inward in the domain. Add a contribution as a **Harmonic Perturbation** by right-clicking the parent node or clicking **Harmonic Perturbation** in the **Physics** toolbar. For more information see [Harmonic Perturbation — Exclusive and Contributing Nodes](#).

NORMAL CURRENT DENSITY

Select a **Type** — **Inward current density** (the default) or **Current density**.

- For **Inward current density** enter a value or expression for the **Normal current density** J_n (SI unit: A/m^2). Use a positive value for an inward current flow or a negative value for an outward current flow. The default is $0 A/m^2$.
- For **Current density** enter values or expressions for the components of the **Current density** \mathbf{J}_0 (SI unit: A/m^2). The defaults are $0 A/m^2$.

Distributed Impedance

The **Distributed Impedance** node adds a distributed impedance boundary condition to a model.

The **Harmonic Perturbation** subnode (it is of the exclusive type) is available from the context menu (right-click the parent node) or in the **Physics** toolbar, click the **Attributes** menu and select **Harmonic Perturbation**. For more information see [Harmonic Perturbation — Exclusive and Contributing Nodes](#).

Use this boundary condition to model a thin sheet of a resistive material connected to a reference potential V_{ref} .

The layer impedance can be specified either with the bulk material conductivity σ_s , the relative permittivity ϵ_r and layer thickness d_s , or directly with the surface resistance ρ_s and capacitance C_s . Assuming DC currents, the equation is:

$$\mathbf{n} \cdot (\mathbf{J}_1 - \mathbf{J}_2) = \frac{\sigma_s}{d_s} (V - V_{\text{ref}})$$

$$\mathbf{n} \cdot (\mathbf{J}_1 - \mathbf{J}_2) = \frac{1}{\rho_s} (V - V_{\text{ref}})$$

DISTRIBUTED IMPEDANCE

Enter the reference potential V_{ref} (SI unit: V). The default is 0 V.

Select a potentially complex-valued **Layer specification** — **Thin layer** (the default) or **Surface impedance**.

- For **Thin layer**, enter values or expressions for the:
 - **Surface thickness** d_s (SI unit: m). The default is $5 \cdot 10^{-3}$ m (5 mm).
 - **Electrical conductivity** σ (SI unit: S/m) and **Relative permittivity** ϵ_r (dimensionless). The defaults take values **From material**. For **User defined**, enter different values or expressions. The default electrical conductivity is $1 \cdot 10^{-2}$ S/m and the default relative permittivity is 1.
- For **Surface impedance**, enter values or expressions for the **Surface resistance** ρ_s (SI unit: $\Omega \cdot \text{m}^2$) and the **Surface capacitance** C_s (SI unit: F/m²). The default surface impedance is $1 \cdot 10^{-8}$ $\Omega \cdot \text{m}^2$ and the default surface capacitance is 0 F/m².

Contact Impedance

Use the **Contact Impedance** node on interior boundaries to model a thin layer of resistive material. It can also be added as a pair using a **Pair Contact Impedance** node. The feature allows specifying the contact impedance either by entering the properties of the material together with the layer thickness, or by entering the impedance properties of the thin layer directly.

The feature applies the following conditions that relate the normal electric current density with the jump in the electric potential:

$$\mathbf{n} \cdot \mathbf{J}_1 = \frac{\sigma}{d_s}(V_1 - V_2)$$

$$\mathbf{n} \cdot \mathbf{J}_2 = \frac{\sigma}{d_s}(V_2 - V_1)$$

$$\mathbf{n} \cdot \mathbf{J}_1 = \frac{1}{\rho_s}(V_1 - V_2)$$

$$\mathbf{n} \cdot \mathbf{J}_2 = \frac{1}{\rho_s}(V_2 - V_1)$$

The first two equations refer to a layer impedance specified using the bulk material conductivity σ_s and the layer thickness d_s , while the last two equations refer to the case in which the surface resistance ρ_s is specified. The indices 1 and 2 refer to the two sides of the boundary. These parameters work the same as with [Distributed Impedance](#).

CONTACT IMPEDANCE

Select a potentially complex-valued **Layer specification** — **Thin layer** (the default) or **Surface impedance**.

- For **Thin layer**, enter values or expressions for the:
 - **Surface thickness** d_s (SI unit: m). The default is $5 \cdot 10^{-3}$ m (5 mm).
 - **Electrical conductivity** σ (SI unit: S/m) and **Relative permittivity** ϵ_r (dimensionless). The defaults take values **From material**. For **User defined**, enter different values or expressions. The default electrical conductivity is $1 \cdot 10^{-2}$ S/m and the default relative permittivity is 1.
- For **Surface impedance**, enter values or expressions for the **Surface resistance** ρ_s (SI unit: $\Omega \cdot m^2$) and the **Surface capacitance** C_s (SI unit: F/m²). The default surface impedance is $1 \cdot 10^{-8}$ $\Omega \cdot m^2$ and the default surface capacitance is 0 F/m².



Thin-Film Resistance: Application Library path **COMSOL_Multiphysics/Electromagnetics/thin_film_resistance**

Sector Symmetry

Select **Sector Symmetry** at interfaces between rotating objects where sector symmetry is used. It is only available for pairs. A default subnode is added. Right-click to select

additional features from the **Fallback Features** submenu. In 2D, this feature assumes rotation around the origin.



This feature is always used in conjunction with a on adjacent radial sector boundaries. Note that the same periodic condition feature cannot be used on both sides of where the sector symmetry boundaries connect with the periodic boundaries. At least two periodic condition features are required for the model to compute correctly.

PAIR SELECTION

When using nonconforming meshes on the source and destination of a pair, for numerical stability, a finer mesh should be applied on the destination side for any pair with a condition that imposes a coupling or a constraint across the pair. The sector symmetry feature falls into this category.

SECTOR SETTINGS

Enter the **Number of sectors (<50)** n_{sect} . The default is 2.

Select a **Type of periodicity** — **Continuity** (the default) or **Antiperiodicity**.

Based on space dimension, enter values or expressions in the table for the **Axis of rotation** \mathbf{a}_{rot} .

CONSTRAINT SETTINGS

To display this section, click the **Show More Options** button () and select **Advanced Physics Options** in the **Show More Options** dialog box. The constraint setting can be set to **Pointwise constraints** (default), or **Weak constraints**. Additionally, the **Nitsche constraints** option is available for the scalar potential in the **Electric Currents, Magnetic Field, No Currents**, and **Rotating Machinery, Magnetic** physics interfaces. The displacement current term is excluded from the **Nitsche constraints** in the **Electric Currents interface** and is therefore valid in the quasistationary approximation.



The **Nitsche constraints** option assumes the quasistatic approximation and is applicable only for pairs adjacent to domains with small or no displacement currents or induced eddy currents normal to the pair boundary. In addition, nonlinear material models in the neighboring domains are not supported.

Line Current Source

The **Line Current Source** node adds a line source to edges in 3D components and to points in 2D and 2D axisymmetric components. The line source represents electric current per unit length.

EDGE OR POINT SELECTION



Beware that constraining the potential on edges or points usually yields a current outflow that is mesh dependent.

LINE CURRENT SOURCE

Enter a value or expression to apply a **Line current source** Q_j (SI unit: A/m). This source represents electric current per unit length. The default is 0 A/m.



[Line Current Source \(on Axis\)](#) for 2D axisymmetric components.

Line Current Source (on Axis)

The **Line Current Source (on Axis)** node adds a line source to boundaries in 2D axisymmetric components. The line source represents electric current per unit length.

LINE CURRENT SOURCE (ON AXIS)

Enter a value or expression to apply a **Line current source** Q_j (SI unit: A/m) to boundaries. This source represents electric current per unit length.



[Line Current Source](#)

Point Current Source

The **Point Current Source** node adds a point source and represents an electric current flowing out of the point. Add point sources to 3D components from the **Points** menu. Add a contribution as a **Harmonic Perturbation** by right-clicking the parent node or

clicking **Harmonic Perturbation** in the **Physics** toolbar. For more information see [Harmonic Perturbation — Exclusive and Contributing Nodes](#).

POINT SELECTION



Beware that constraining the potential on points usually yields a current outflow that is mesh dependent.

POINT CURRENT SOURCE

Enter a value or expression to apply a **Point current source** Q_j (SI unit: A) to points. This source represents an electric current flowing out of the point.



- [Line Current Source](#) for 2D components
- [Point Current Source \(on Axis\)](#) for 2D axisymmetric components

Point Current Source (on Axis)

The **Point Current Source (on Axis)** node adds a point source and represents an electric current flowing out of the point in 2D axisymmetric components.

POINT SELECTION



Beware that constraining the potential on points usually yields a current outflow that is mesh dependent.



POINT CURRENT SOURCE

Enter a value or expression to apply a **Point current source** Q_j (SI unit: A) to points. This source represents an electric current flowing out of the point.



- [Point Current Source](#) for 3D components
- [Line Current Source](#) for 2D components

The Electrical Circuit Interface

The **Electrical Circuit (cir)** interface () , found under the **AC/DC** branch () when adding a physics interface, is used to model currents and voltages in circuits including voltage and current sources, resistors, capacitors, inductors, and semiconductor devices. Models created with the Electrical Circuit interface can include connections to distributed field models. The physics interface supports stationary, frequency-domain and time-domain modeling and solves Kirchhoff's conservation laws for the voltages, currents, and charges associated with the circuit elements.

When this physics interface is added, it adds a default **Ground Node** feature and associates that with node zero in the electrical circuit.



Circuit nodes are nodes in the electrical circuit (electrical nodes) and should not be confused with nodes in the Model Builder tree of the COMSOL Multiphysics software. Circuit node names are not restricted to numerical values but can contain alphanumeric characters.

SETTINGS

The **Label** is the default physics interface name.

The **Name** is used primarily as a scope prefix for variables defined by the physics interface. Refer to such physics interface variables in expressions using the pattern `<name>.<variable_name>`. In order to distinguish between variables belonging to different physics interfaces, the `name` string must be unique. Only letters, numbers, and underscores (`_`) are permitted in the **Name** field. The first character must be a letter.

The default **Name** (for the first physics interface in the model) is `cir`.

RESISTANCE IN PARALLEL TO PN JUNCTIONS

For numerical stability, a large resistance is added automatically in parallel to the pn junctions in diodes and BJT devices. Enter a default value for the **Resistance in parallel to pn junctions** R_j ; (SI unit: Ω). The default value is $1 \cdot 10^{12} \Omega$.

CREATE UNIQUE NODES FOR NEW DEVICES

When this setting is selected (the default), newly added devices will be assigned unused node names. The devices will be disconnected from the rest of the circuit and the nodes should be updated to reflect the actual circuit connections. When this setting is

deselected, new devices will be connected to the lowest-numbered nodes starting from 0.

ELECTRICAL CIRCUIT TOOLBAR

The following nodes are available from the **Electrical Circuit** ribbon toolbar (Windows users), **Electrical Circuit** context menu (Mac or Linux users), or right-click to access the context menu (all users):



For step-by-step instructions and general documentation descriptions, this is the **Electrical Circuit** toolbar.

- Ground Node
- Voltmeter
- Ampère Meter
- Resistor
- Capacitor
- Inductor
- Voltage Source
- Current Source
- Diode
- Switch
- Voltage-Controlled Voltage Source¹
- Voltage-Controlled Current Source¹
- Current-Controlled Voltage Source¹
- Current-Controlled Current Source¹
- Subcircuit Definition
- Subcircuit Instance
- Mutual Inductance
- Transformer
- Battery Open Circuit Voltage
- Resistor-Capacitor Couple
- NPN BJT and PNP BJT²
- n-Channel MOSFET and p-Channel MOSFET²
- External I vs. U³
- External U vs. I³
- External I-Terminal³
- SPICE Circuit Import
- SPICE Circuit Export

¹ Selected from the **Dependent Sources** submenu when you right-click main node.

² Selected from the **Transistors** submenu when you right-click main node.

³ Selected from the **External Couplings** submenu when you right-click main node.

Ground Node

The **Ground Node** () feature adds a ground node with the default node number zero to the electrical circuit. This is the default node in the Electrical Circuit interface. More

ground nodes can be added but those must have unique node numbers and are by default given higher node numbers.

GROUND CONNECTION

Set the **Node name** for the ground node in the circuit. The convention is to use 0 (zero) for the ground node. If adding more ground nodes, each must have a unique node name (number).

Voltmeter

The **Voltmeter** () feature connects a voltmeter (voltage measurement device) between two nodes in the electrical circuit. A voltmeter behaves electrically as an open circuit. The voltmeter node adds a Probe sampling the voltage across it.

NODE CONNECTIONS

Set the two **Node names** for the connecting nodes for the resistor.

Ampère Meter

The **Ammeter** () feature connects an ammeter (current measurement device) between two nodes in the electrical circuit. An ammeter behaves electrically as a short circuit. The ammeter node adds a Probe sampling the current through it.

NODE CONNECTIONS

Set the two **Node names** for the connecting nodes for the resistor.

DEVICE PARAMETERS

Enter the **Resistance** of the resistor.

Resistor

The **Resistor** () feature connects a resistor between two nodes in the electrical circuit.

NODE CONNECTIONS

Set the two **Node names** for the connecting nodes for the resistor.

DEVICE PARAMETERS

Enter the **Resistance** of the resistor.

Capacitor

The **Capacitor** () feature connects a capacitor between two nodes in the electrical circuit.

NODE CONNECTIONS

Set the two **Node names** for the connecting nodes for the capacitor.

DEVICE PARAMETERS

Enter the **Capacitance** of the capacitor.

Inductor

The **Inductor** () feature connects an inductor between two nodes in the electrical circuit.

NODE CONNECTIONS

Set the two **Node names** for the connecting nodes for the inductor.

DEVICE PARAMETERS

Enter the **Inductance** of the inductor.

Voltage Source

The **Voltage Source** () feature connects a voltage source between two nodes in the electrical circuit.

NODE CONNECTIONS

Set the two **Node names** for the connecting nodes for the voltage source. The first node represents the positive reference terminal.

DEVICE PARAMETERS

Enter the **Source type** that should be adapted to the selected study type. It can be **General source**, **AC-source**, or a time-dependent **Sine source** or **Pulse source**. Depending on the choice of source, also specify the following parameters:

- For a General source, the **Voltage V_{src}** (default value: 1 V). General sources are active in Stationary, Time-Dependent and Frequency Domain studies.
- For an AC-source: the **Voltage V_{src}** (default value: 1 V) and the **Phase Θ** (default value: 0 rad). AC-sources are active in Frequency Domain studies only.

- For a sine source: the **Voltage V_{src}** (default value: 1 V), the **Offset V_{off}** (default value: 0 V), the **Frequency** (default value: 1 kHz), and the **Phase Θ** (default value: 0 rad). The sine sources are active in Time-Dependent studies and also in Stationary studies, providing that a value for t has been provided as a model parameter or global variable.
- For a pulse source: the **Voltage V_{src}** (default value: 1 V), the **Offset V_{off}** (default value: 0 V), the **Delay t_d** (default value: 0s), the **Rise time t_r** and **Fall time t_f** (default values: 0 s), the **Pulse width p_w** (default value: 1 μ s), and the **Period T_{per}** (default value: 2 μ s). The pulse sources are active in Time-Dependent studies and also in Stationary studies, providing that a value for t has been provided as a model parameter or global variable.

All values are peak values rather than RMS.



For the AC source, the frequency is a global input set by the solver. AC sources should be used in Frequency-domain studies only. Do not use the **Sine source** unless the model is time dependent.

Current Source

The **Current Source** () feature connects a current source between two nodes in the electrical circuit.

NODE CONNECTIONS

Set the two **Node names** for the connecting nodes for the current source. The first node represents the positive reference terminal from where the current flows through the source to the second node.

DEVICE PARAMETERS

Enter the **Source type** that should be adapted to the selected study type. It can be **General source**, **AC-source**, or a time-dependent **Sine source** or **Pulse source**. Depending on the choice of source, also specify the following parameters:

- For a General source, the **Current i_{src}** (default value: 1 A). General sources are active in Stationary, Time-Dependent and Frequency Domain studies.
- For an AC-source: the **Current i_{src}** (default value: 1 A) and the **Phase Θ** (default value: 0 rad). AC-sources are active in Frequency Domain studies only.

- For a sine source: the **Current** i_{src} (default value: 1 A), the **Offset** i_{off} (default value: 0 A), the **Frequency** (default value: 1 kHz), and the **Phase** Θ (default value: 0 rad). The sine sources are active in Time-Dependent studies and also in Stationary studies, providing that a value for t has been provided as a model parameter or global variable.
- For a pulse source: the **Current** i_{src} (default value: 1 A), the **Offset** i_{off} (default value: 0 A), the **Delay** t_d (default value: 0 s), the **Rise time** t_r and **Fall time** t_f (default values: 0 s), the **Pulse width** p_w (default value: 1 μ s), and the **Period** T_{per} (default value: 2 μ s). The pulse sources are active in Time-Dependent studies and also in Stationary studies, providing that a value for t has been provided as a model parameter or global variable.

All values are peak values rather than RMS.



For the AC source, the frequency is a global input set by the solver. AC sources should be used in frequency-domain studies only. Do not use the **Sine source** unless the model is time dependent.

Voltage-Controlled Voltage Source

The **Voltage-Controlled Voltage Source** () feature connects a voltage-controlled voltage source between two nodes in the electrical circuit. A second pair of nodes define the input control voltage.

NODE CONNECTIONS

Specify four **Node names**: the first pair for the connection nodes for the voltage source and the second pair defining the input control voltage. The first node in a pair represents the positive reference terminal.

DEVICE PARAMETERS

There are two options to define the relationship between the control voltage and resulting voltage. The **Use gain** method defines the resulting voltage to be the control voltage multiplied by the gain. The **Custom expression** method can define the relationship with an arbitrary expression.

Voltage-Controlled Current Source

The **Voltage-Controlled Current Source** () feature connects a voltage-controlled current source between two nodes in the electrical circuit. A second pair of nodes define the input control voltage.

NODE CONNECTIONS

Specify four **Node names**: the first pair for the connection nodes for the current source and the second pair defining the input control voltage. The first node in a pair represents the positive voltage reference terminal or the one from where the current flows through the source to the second node.

DEVICE PARAMETERS

There are two options to define the relationship between the control voltage and resulting current. The **Use gain** method defines the resulting current to be the control voltage multiplied by the gain (SI units: S). The **Custom expression** method can define the relationship with an arbitrary expression.

Current-Controlled Voltage Source

The **Current-Controlled Voltage Source** () feature connects a current-controlled voltage source between two nodes in the electrical circuit. The input control current is the one flowing through a two-pin device.

NODE CONNECTIONS

Set two **Node names** for the connection nodes for the voltage source. The first node in a pair represents the positive reference terminal.

DEVICE PARAMETERS

There are two options to define the relationship between the control current and resulting voltage. The **Use gain** method defines the resulting voltage to be the control current multiplied by the gain (SI units: Ω). The **Custom expression** method can define the relationship with an arbitrary expression.

Current-Controlled Current Source

The **Current-Controlled Current Source** () feature connects a current-controlled current source between two nodes in the electrical circuit. The input control current is the one flowing through a named device that must be a two-pin device.

NODE CONNECTIONS

Specify two **Node names** for the connection nodes for the current source. The first node in a pair represents the positive reference terminal from where the current flows through the source to the second node.

DEVICE PARAMETERS

There are two options to define the relationship between the control current and resulting current. The **Use gain** method defines the resulting current to be the control current multiplied by the gain. The **Custom expression** method can define the relationship with an arbitrary expression.

Switch

The **Switch** () feature is used to connect or disconnect the conducting path in a circuit under specific conditions.

NODE CONNECTIONS

Specify two **Node names** for the connection nodes for the current source. The first node in a pair represents the positive reference terminal from where the current flows through the source to the second node.

SWITCH CONDITIONS

There are three types of conditions, **Voltage controlled**, **Current controlled**, and **Custom expressions**. For each type of condition there are two conditions, one for turn on and one for turn off. The on condition is true if the **On condition** expression is larger than zero, while the off condition is true if the **Off condition** is less than zero.

The **Initial state** list has three options, **Use on condition**, **Use off condition**, and **Boolean expression**. The two former options mean that the switch will have an initial state matching to the on or off condition. The third option makes the switch's initial state match a custom Boolean expression. Separating on, off, and initial states makes the switch more flexible and can support Schmitt-trigger style switches and various latches.

For the **Voltage controlled** switch, it is necessary to specify two nodes that defines the voltage `sens.v` that the switch state depends on. The conditions must be written as a function of this variable. Similarly, for the **Current controlled** switch it is necessary to specify a two-pin device that defines the current `sens.i` that the switch state depends on.

SWITCH PARAMETERS

When the switch is in the on state it has a nonzero resistance specified by the **On resistance** expression. For the off state no current flows through the switch (infinite resistance). There is also a transition time for the switch to turn on and off set by the **Switching time** expression. The switch triggers an implicit event that updates a discrete state variable (with suffix `_state`).

Subcircuit Definition

The **Subcircuit Definition** () feature is used to define subcircuits, which can be inserted as devices into the main circuit using **Subcircuit Instance** nodes. Create the subcircuit by adding subnodes to the **Subcircuit Definition** node, either by using the **Physics** toolbar, or by right-clicking the **Subcircuit Definition**.

SUBCIRCUIT PINS

Define the **Pin names** at which the subcircuit connects to the main circuit or to other subcircuits when referenced by a **Subcircuit Instance** node. The **Pin names** refer to circuit nodes in the subcircuit. The order in which the **Pin names** are defined is the order in which they are referenced by a Subcircuit Instance node. The devices constituting the subcircuit should be connected only to the subcircuit's pins and to themselves.

INPUT PARAMETERS

To display this section, click the **Show More Options** button () and select **Advanced Physics Options**. Specify input parameters to a subcircuit that can be changed from a subcircuit instance. These input parameters can be used in all expression-style edit fields that affect the parameters of a device, for example, resistance, capacitance, and current gain. In this way, a subcircuit can represent a parameterized custom device model.

Subcircuit Instance

The **Subcircuit Instance** () feature represents an instance of a subcircuits defined by a **Subcircuit Definition** feature.



NODE CONNECTIONS

Select the **Name of subcircuit link** from the list of defined subcircuits in the circuit model and the circuit **Node names** at which the subcircuit instance connects to the main circuit or to another subcircuit if used therein.

INPUT PARAMETERS

To display this section, click the **Show More Options** button () and select **Advanced Physics Options**. Specify input parameters to a subcircuit that can be changed from a subcircuit instance. These input parameters can be used in all expression-style edit fields that affect the parameters of a device, for example, resistance, capacitance, and current gain. In this way, a subcircuit can represent a parameterized custom device model.

NPN BJT and PNP BJT

The **NPN BJT** () and the **PNP BJT** () device models are large-signal models for bipolar junction transistors (BJT). It is an advanced device model and no thorough description and motivation of the many input parameters are attempted here. Many device manufacturers provide model input parameters for this BJT model. For any particular make of BJT, the device manufacturer should be the primary source of information.

NODE CONNECTIONS

Specify three **Node names** for the connection nodes for the **BJT** device. These represent the *collector*, *base*, and *emitter* nodes for the **NPN** transistor, and the *emitter*, *base*, and *collector* nodes for the **PNP** transistor.

MODEL PARAMETERS



Specify the **Model Parameters**. Reasonable defaults are provided but for any particular BJT, the device manufacturer should be the primary source of information.



The interested reader is referred to [Ref. 1](#) for more details on semiconductor modeling within circuits.

For an explanation of the **Model Parameters** see [Bipolar Transistors](#).

n-Channel MOSFET and p-Channel MOSFET

The **n-Channel MOSFET** () and the **p-Channel MOSFET** () device models are large-signal models for, respectively, an n-Channel MOS field-effect transistor (MOSFET) and p-Channel MOSFET. These are advanced device models and no thorough description and motivation of the many input parameters are attempted here. Many device manufacturers provide model parameters for the MOSFET models.

For any particular make of MOSFET, the device manufacturer should be the primary source of information.

NODE CONNECTIONS

Specify four **Node names** for the connection nodes for the **n-Channel MOSFET** or **p-Channel MOSFET** device. These represent the *drain*, *gate*, *source*, and *bulk* nodes, respectively.

MODEL PARAMETERS

Specify the **Model Parameters**. Reasonable defaults are provided but for any particular MOSFET, the device manufacturer should be the primary source of information.



The interested reader is referred to [\[reference\]](#) for more details on semiconductor modeling within circuits.

For an explanation of the **Model Parameters** see [MOSFET Transistors](#).

Mutual Inductance

The **Mutual Inductance** allows specifying a coupling between two existing **Inductor** features in the circuit. The mutual inductance of the coupling is

$$M = k\sqrt{L_1L_2}$$

where k is the coupling factor and L_1 and L_2 are the inductances of the inductors.

DEVICE PARAMETERS

Enter values or expressions for the:

- **Coupling factor** k (dimensionless). The value must be between 0 and 1, and the default is 0.98.
- **First inductance** L_1 (SI unit: H) and **Second inductance** L_2 (SI unit: H). These must be set to two different **Inductor** features in the circuit.

Transformer

The **Transformer** feature represents either a combination of two **Inductor** and a **Mutual Inductance** features, or an ideal transformer.

NODE CONNECTIONS

Enter or edit the table in the **Node names** column for the **primary** and **secondary** node connections.

DEVICE PARAMETERS

Choose a **Transformer model** — **Specify inductors** (the default) or **Ideal transformer**.

For **Specify inductors** enter values or expressions for the:

- **Coupling factor** k (dimensionless). The default is 0.98.
- **First inductance** L_1 (SI unit: H). The default is 1 mH.
- **Second inductance** L_2 (SI unit: H). The default is 1 mH.

For **Ideal transformer** enter values or expressions for the **Winding ratio** N_1/N_2 (dimensionless). The default is 10.

Battery Open Circuit Voltage

The **Battery Open Circuit Voltage** node defines a voltage source in the circuit that depends on the state-of-charge of a battery. In time-dependent simulations the state-of-charge is calculated by integrating the current passing through the circuit element, using the **Battery cell capacity** and **Initial state-of-charge** parameters.

Use the table in the **Open Circuit Voltage** section to define how the voltage depends on the state-of-charge.

The **Temperature derivative of open circuit** settings may be used to define a temperature-dependent open circuit voltage, and a reversible (entropic) heat source.

Resistor-Capacitor Couple

The **Resistor-Capacitor Couple** node defines a resistor and capacitor coupled in parallel. The device model has two modes of operation which are using either the **Resistance and capacitance** values or the **Resistance and time-constant** values as input.

NODE CONNECTIONS

Specify two **Node names** for the positive and negative nodes for the **Resistor-capacitor couple** device.

Diode

The **Diode** device model () is a large-signal model for a diode. It is an advanced device model and no thorough description and motivation of the many input parameters are attempted here. The interested reader is referred to for more details on semiconductor modeling within circuits. Many device manufacturers provide model parameters for this diode model. For any particular make of diode, the device manufacturer should be the primary source of information.

NODE CONNECTIONS

Specify two **Node names** for the positive and negative nodes for the **Diode** device.

MODEL PARAMETERS

Specify the **Model Parameters**. Reasonable defaults are provided but for any particular diode, the device manufacturer should be the primary source of information.



For an explanation of the **Model Parameters** see [Diode](#).

External I vs. U

The **External I vs. U** () feature connects an arbitrary voltage measurement (for example, a circuit terminal or circuit port boundary or a coil domain from another physics interface) as a voltage source between two nodes in the electrical circuit. The resulting circuit current from the first node to the second node is typically coupled back as a prescribed current source in the context of the voltage measurement.

NODE CONNECTIONS

Specify the two **Node names** for the connecting nodes for the voltage source. The first node represents the positive reference terminal.

EXTERNAL DEVICE

Enter the source of the **Voltage**. If circuit or current excited terminals or circuit ports are defined on boundaries or domains or a multiturn coil domains is defined in other physics interfaces, these display as options in the **Voltage** list. Also select the **User defined** option and enter your own voltage variable, for example, using a suitable coupling operator. For inductive or electromagnetic wave propagation models, the voltage measurement must be performed as an integral of the electric field because the electric

potential only does not capture induced EMF. Also the integration must be performed over a distance that is short compared to the local wavelength.



Except when coupling to a circuit terminal, circuit port, or coil, the current flow variable must be manually coupled back in the electrical circuit to the context of the voltage measurement. This applies also when coupling to a current excited terminal. The name of this current variable follows the convention `circn.IvsUm_i`, where `circn` is the tag of the Electrical Circuit interface node and `IvsUm` is the tag of the **External I vs. U** node. The tags are typically displayed within curly brackets `{ }` in the Model Builder.



[Nonlocal Couplings and Coupling Operators](#) in the *COMSOL Multiphysics Reference Manual*

External U vs. I

The **External U vs. I** () feature connects an arbitrary current measurement (for example, a coil domain from another physics interface) as a current source between two nodes in the electrical circuit. The resulting circuit voltage between the first node and the second node is typically coupled back as a prescribed voltage source in the context of the current measurement.

NODE CONNECTIONS

Specify the two **Node names** for the connecting nodes for the current source. The current flows from the first node to the second node.

EXTERNAL DEVICE

Enter the source of the **Current**. Voltage excited terminals or lumped ports defined on boundaries in other physics interfaces are natural candidates but do not appear as options in the **Voltage** list because those do not have an accurate built-in current

measurement variable. A **User defined** option must be selected and a current variable entered, for example, using a suitable coupling operator.



The voltage variable must be manually coupled back in the electrical circuit to the context of the current measurement. This applies also when coupling to a voltage excited terminal or lumped port. The name of this voltage variable follows the convention `cirn.UvsIm_v`, where `cirn` is the tag of the Electrical Circuit interface node and `UvsIm` is the tag of the **External U vs. I** node. The tags are typically displayed within curly brackets `{}` in the Model Builder.



[Nonlocal Couplings and Coupling Operators](#) in the *COMSOL Multiphysics Reference Manual*

External I-Terminal

The **External I-Terminal** () feature connects an arbitrary voltage-to-ground measurement (for example, a circuit terminal from another physics interface) as a voltage-to-ground assignment to a node in the electrical circuit. The resulting circuit current from the node is typically coupled back as a prescribed current source in the context of the voltage measurement. This node does not apply when coupling to inductive or electromagnetic wave propagation models because then voltage must be defined as a line integral between two points rather than a single point measurement of electric potential. For such couplings, use the [External I vs. U](#) node instead.

NODE CONNECTIONS

Set the **Node name** for the connecting node for the voltage assignment.

EXTERNAL TERMINAL

Enter the source of the **Voltage**. If circuit- or current-excited terminals are defined on boundaries in other physics interfaces, these display as options in the **Voltage** list. Also

select the **User defined** option and enter a voltage variable, for example, using a suitable coupling operator.



- Except when coupling to a circuit terminal, the current flow variable must be manually coupled back in the electrical circuit to the context of the voltage measurement. This applies also when coupling to a current excited terminal. The name of this current variable follows the convention `cirn.termIm_i`, where `cirn` is the tag of the Electrical Circuit interface node and `termIm` is the tag of the **External I-Terminal** node. The tags are typically displayed within curly brackets `{}` in the Model Builder.
- When connecting the finite element model between two circuit nodes that both are not grounded, the **External I-Terminal** node cannot be used. In this case, use [External I vs. U](#) or [External U vs. I](#) instead.



[Nonlocal Couplings and Coupling Operators](#) in the *COMSOL Multiphysics Reference Manual*.



SPICE Circuit Import

Right-click the **Electrical Circuit** () feature node to import an existing SPICE netlist (select **Import Spice Netlist**). A window opens — enter a file location or browse your directories to find one. The default file extension for a SPICE netlist is `.cir`. The SPICE circuit import translates the imported netlist into Electrical Circuit interface nodes so these define the subset of SPICE features that can be imported.



See [SPICE Import and Export](#) about the supported SPICE commands.

SPICE Circuit Export

Right-click the **Electrical Circuit** () feature node to export the current circuit to the SPICE netlist file format (select **Export Spice Netlist** ). A window opens — enter a

file location or browse your directories to find one. The default file extension for a SPICE netlist is `.cir`. The compatible circuit nodes are exported as SPICE devices



See [SPICE Circuit Export](#) for more details on the supported SPICE commands.

Theory for the Electrostatics Interface

is available for 3D, 2D in-plane, and 2D axisymmetric components. Applications with electrostatic equations include high-voltage apparatus, electronic devices, and capacitors. The term “statics” is not to be interpreted literally — it is the observation time, or time scale at which the applied excitation changes, that is short compared to the charge relaxation time; also, the electromagnetic wavelength and skin depth are very large compared to the size of the domain of interest.

If you do not know whether to use the Electric Currents or the Electrostatics interface, which both solve for the scalar electric potential V , consider using an explicit charge transport model. See [Charge Relaxation Theory](#).

Charge Relaxation Theory

COMSOL Multiphysics includes physics interfaces for the modeling of static electric fields and currents. Deciding what specific physics interface and study type to select for a particular modeling situation requires a basic understanding of the charge dynamics in conductors.

The different physics interfaces involving only the scalar electric potential can be interpreted in terms of the charge relaxation process. The fundamental equations involved are *Ohm's law* for the conduction current density

$$\mathbf{J}_c = \sigma \mathbf{E}$$

the *equation of continuity*

$$\frac{\partial \rho}{\partial t} + \nabla \cdot \mathbf{J}_c = 0$$

and *Gauss' law*

$$\nabla \cdot (\epsilon \mathbf{E}) = \rho$$

By combining these, one can deduce the following differential equation for the space charge density in a homogeneous medium

$$\frac{\partial \rho}{\partial t} + \frac{\sigma}{\epsilon} \rho = 0$$

This equation has the solution

$$\rho(t) = \rho_0 e^{-t/\tau}$$

where

$$\tau = \frac{\epsilon}{\sigma}$$

is called the charge relaxation time. For a good conductor like copper, τ is of the order of 10^{-19} s, whereas for a good insulator like silica glass, it is of the order of 10^3 s. For a pure insulator, it becomes infinite.

When modeling real-world devices, there is not only the *intrinsic time scale* of the charge relaxation time but also an *external time scale* t at which a device is energized or the observation time. It is the relation between the external time scale and the charge relaxation time that determines what physics interface and study type to use. The results are summarized in [Table 5-3](#) below,

TABLE 5-3: SUITABLE PHYSICS INTERFACE AND STUDY TYPE FOR DIFFERENT TIME-SCALE REGIMES.

CASE	PHYSICS INTERFACE	STUDY TYPE
$\tau \gg t$	Electrostatics	Stationary
$\tau \ll t$	Electric Currents	Stationary
$\tau \sim t$	Electric Currents	Time Dependent or Frequency Domain

FIRST CASE: $\tau \gg t$

If the external time scale is short compared to the charge relaxation time, the charges do not have time to redistribute to any significant degree. Thus the charge distribution can be considered as a given model input. The best approach is to solve the Electrostatics formulation using the electric potential V .

By combining the definition of the potential with Gauss' law, you can derive the classical Poisson's equation. Under static conditions, the electric potential V is defined by the equivalence $\mathbf{E} = -\nabla V$. Using this together with the constitutive relation $\mathbf{D} = \epsilon_0 \mathbf{E} + \mathbf{P}$ between \mathbf{D} and \mathbf{E} , you can rewrite Gauss' law as a variant of Poisson's equation

$$-\nabla \cdot (\epsilon_0 \nabla V - \mathbf{P}) = \rho$$

This equation is used in the Electrostatics interface. It is worth noting that Gauss' law does not require the charge distribution to be static. Thus, provided dynamics are slow enough that induced electric fields can be neglected and hence a scalar electric potential is justified, the formulation can be used also in the Time Dependent study type. That typically involves either prescribing the charge dynamics or coupling a separate formulation for this.



Such separate charge transport formulations can be found in the Plasma Module, the Semiconductor Module, and the Chemical Reaction Engineering Module.

SECOND CASE: $\tau \ll T$

If the external time scale is long compared to the charge relaxation time, the stationary solution to the equation of continuity has been reached. In a stationary coordinate system, a slightly more general form of Ohm's law than above states that

$$\mathbf{J}_c = \sigma \mathbf{E} + \mathbf{J}_e$$

where \mathbf{J}_e is an externally generated current density. The static form of the equation of continuity then reads

$$\nabla \cdot \mathbf{J}_c = -\nabla \cdot (\sigma \nabla V - \mathbf{J}_e) = 0$$

To handle current sources, the equation can be generalized to

$$-\nabla \cdot (\sigma \nabla V - \mathbf{J}_e) = Q_j$$

This equation is used in the static study type for the Electric Currents interface.

Electrostatics Equations

Under static conditions, the electric potential, V , is defined by the relationship:

$$\mathbf{E} = -\nabla V$$

Combining this equation with the constitutive relationship $\mathbf{D} = \epsilon_0 \mathbf{E} + \mathbf{P}$ between the electric displacement \mathbf{D} and the electric field \mathbf{E} , it is possible to represent Gauss' law as the following equation:

$$-\nabla \cdot (\epsilon_0 \nabla V - \mathbf{P}) = \rho$$

In this equation, the physical constant, ϵ_0 (SI unit: F/m) is the permittivity of vacuum, \mathbf{P} (SI unit: C/m²) is the electric polarization vector, and ρ (SI unit: C/m³) is a space charge density. This equation describes the electrostatic field in dielectric materials.

For in-plane 2D modeling, the Electrostatics interface assumes a symmetry where the electric potential varies only in the x and y directions and is constant in the z direction. This implies that the electric field, \mathbf{E} , is tangential to the xy -plane. With this symmetry, the same equation is solved as in the 3D case. The physics interface solves the following equation where d is the thickness in the z direction:

$$-\nabla \cdot d(\epsilon_0 \nabla V - \mathbf{P}) = \rho$$

The axisymmetric version of the physics interface considers the situation where the fields and geometry are axially symmetric. In this case, the electric potential is constant in the ϕ direction, which implies that the electric field is tangential to the rz -plane.

The Electrostatics Interface in Time Dependent or Frequency Domain Studies

can also be solved in a dynamic study (Time Dependent or Frequency Domain). The equation system solved, however, is typically always the one presented in the previous section for the stationary case, in which no transient electromagnetic effects are taken into account. The difference is that the sources of the problem (charge densities, electric potential) are assumed to be time-varying (in a Time Dependent study) or time-harmonic (in a Frequency Domain study).

The support for dynamic studies simplifies the coupling of the Electrostatics interface with other physics interfaces. Using the physics interface in a dynamic study is a valid approximation only if the time-scale (or the frequency) of the study is so slow that transient electromagnetic effects can be neglected; for example, in acoustic or structural problems.

The Electrostatics interface also supports the small-signal analysis study sequence, which can be used when a time-harmonic perturbation is superposed on a static bias charge or voltage.

Theory for the Electric Currents Interface

solves a current conservation problem for the scalar electric potential V and is available for 3D, 2D in-plane, and 2D axisymmetric components. Electrolysis, conductors, and the computation of resistances of grounding plates are examples that involve conductive media with electrical conductivities and electric currents. If you are uncertain of whether to use the Electric Currents or the Electrostatics interface, which both solve for the scalar electric potential V , refer to the section on .

The Electric Currents Interface assumes that there is only one type of charge carrier. When there are multiple charge carriers, it is often necessary to solve the transport equation for each charge carrier as well as the Poisson's equation with Electrostatics interface.

Electric Currents Equations in Steady State

When handling stationary electric currents in conductive media you must consider the stationary equation of continuity. In a stationary coordinate system, the point form of *Ohm's law* states that:

$$\mathbf{J} = \sigma \mathbf{E} + \mathbf{J}_e$$

where σ is the electrical conductivity (SI unit: S/m), and \mathbf{J}_e is an externally generated current density (SI unit: A/m²). The static form of the equation of continuity then states:

$$\nabla \cdot \mathbf{J} = -\nabla \cdot (\sigma \nabla V - \mathbf{J}_e) = 0$$

To handle current sources, you can generalize the equation to:

$$-\nabla \cdot (\sigma \nabla V - \mathbf{J}_e) = Q_j$$

In planar 2D the Electric Currents interface assumes that the model has a symmetry where the electric potential varies only in the x and y directions and is constant in the z direction. This implies that the electric field, \mathbf{E} , is tangential to the xy -plane. The Electric Currents interface then solves the following equation, where d is the thickness in the z direction:

$$-\nabla \cdot d(\sigma \nabla V - \mathbf{J}_e) = dQ_j \quad (5-1)$$

In 2D axisymmetry, the Electric Currents interface considers the situation where the fields and geometry are axially symmetric. In this case, the electric potential is constant in the φ direction, which implies that the electric field is tangential to the rz -plane.

Theory for the Electrical Circuit Interface

The [Electrical Circuit Interface](#) theory is discussed in this section:

- [Electric Circuit Modeling and the Semiconductor Device Models](#)
- [Bipolar Transistors](#)
- [MOSFET Transistors](#)
- [Diode](#)
- [Reference for the Electrical Circuit Interface](#)



[Connecting to Electrical Circuits](#)

Electric Circuit Modeling and the Semiconductor Device Models

Electrical circuit modeling capabilities are useful when simulating all sorts of electrical and electromechanical devices ranging from heaters and motors to advanced plasma reactors in the semiconductor industry. There are two fundamental ways that an electrical circuit model relates to a physical field model.

- The field model is used to get a better, more accurate description of a single device in the electrical circuit model.
- The electrical circuit is used to drive or terminate the device in the field model in such a way that it makes more sense to simulate both as a tightly coupled system.

The Electrical Circuit interface makes it possible to add nodes representing circuit elements directly to the Model Builder tree in a COMSOL Multiphysics model. The circuit variables can then be connected to a physical device model to perform co-simulations of circuits and multiphysics. The model acts as a device connected to the circuit so that its behavior is analyzed in larger systems.

The fundamental equations solved by the Electrical Circuit interface are Kirchhoff's circuit laws, which in turn can be deduced from Maxwell's equations. The supported study types are Stationary, Frequency Domain, and Time Dependent.

There are three more advanced large-signal semiconductor device features available in the Electrical Circuit interface. The equivalent circuits and the equations defining their nonideal circuit elements are described in this section. For a more complete treatise on semiconductor device modeling, see [Ref. 1](#).

Bipolar Transistors

Figure 5-1 illustrates the equivalent circuit for the npn bipolar junction transistor.

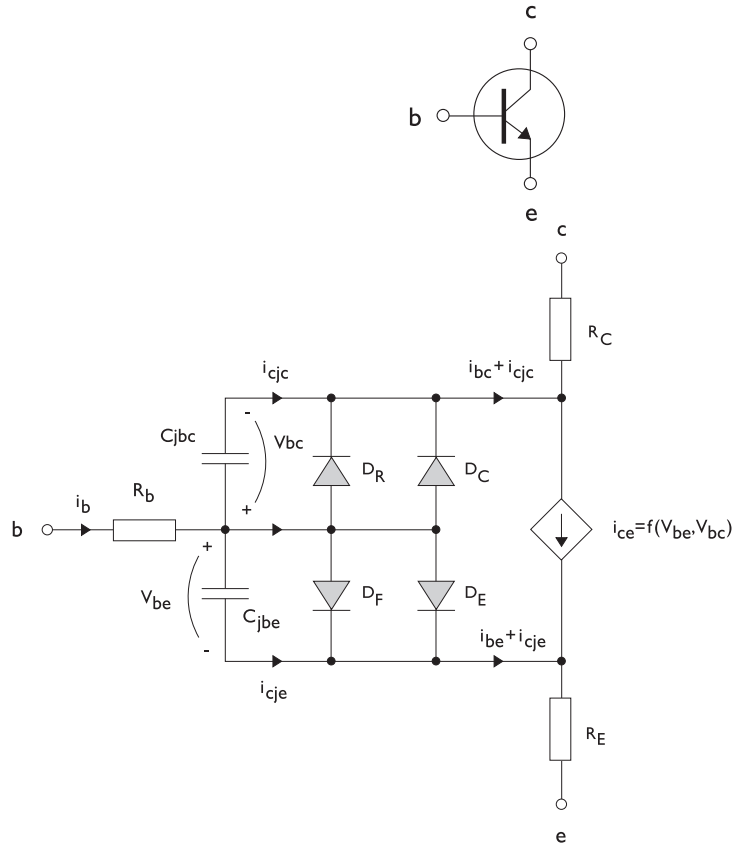

Figure 5-1: A circuit for the bipolar transistor.

The pnp transistor model is similar in all regards to the npn transistor, with the difference that the polarities of the currents and voltages involved are reversed. The following equations are used to compute the relations between currents and voltages in the circuit.

$$v_{rb} = \frac{1}{A} \left(R_{BM} - \frac{R_B - R_{BM}}{f_{bq}} \right) i_b$$

$$f_{bq} = \frac{1}{2 \left(1 - \frac{v_{bc}}{V_{AF}} - \frac{v_{be}}{V_{AR}} \right)} \left(1 + \sqrt{1 + 4 I_S \left(\frac{e^{\frac{v_{bc}}{N_F V_T}} - 1}{I_{KF} A} + \frac{e^{\frac{v_{be}}{N_R V_T}} - 1}{I_{KR} A} \right)} \right)$$

$$i_{be} = A \left(\frac{I_S}{B_F} \left(e^{\frac{v_{be}}{N_F V_T}} - 1 \right) + I_{SE} \left(e^{\frac{v_{be}}{N_E V_T}} - 1 \right) \right)$$

$$i_{bc} = A \left(\frac{I_S}{B_R} \left(e^{\frac{v_{bc}}{N_R V_T}} - 1 \right) + I_{SC} \left(e^{\frac{v_{bc}}{N_C V_T}} - 1 \right) \right)$$

$$i_{ce} = A \left(\frac{I_S}{f_{bq}} \left(e^{\frac{v_{bc}}{N_F V_T}} + e^{\frac{v_{be}}{N_C V_T}} \right) \right)$$

$$V_T = \frac{k_B T_{NOM}}{q}$$

There are also two capacitances that use the same formula as the junction capacitance of the diode model. In the parameter names below, replace x with C for the base-collector capacitance and E for the base-emitter capacitance.

$$C_{jbx} = AC_{Jx} \times \begin{cases} \left(1 - \frac{v_{bx}}{V_{Jx}} \right)^{-M_{Jx}} & v_{bx} < F_C V_{Jx} \\ (1 - F_C)^{-1 - M_{Jx}} \left(1 - F_C (1 + M_{Jx}) + M_{Jx} \frac{v_{bx}}{V_{Jx}} \right) & v_{bx} \geq F_C V_{Jx} \end{cases}$$

The model parameters are listed in the table below.

TABLE 5-1: BIPOLAR TRANSISTOR MODEL PARAMETERS.

PARAMETER	DEFAULT	DESCRIPTION
B_F	100	Ideal forward current gain
B_R	1	Ideal reverse current gain
C_{JC}	0 F/m ²	Base-collector zero-bias depletion capacitance
C_{JE}	0 F/m ²	Base-emitter zero-bias depletion capacitance
F_C	0.5	Breakdown current
I_{KF}	Inf (A/m ²)	Corner for forward high-current roll-off
I_{KR}	Inf (A/m ²)	Corner for reverse high-current roll-off

TABLE 5-1: BIPOLAR TRANSISTOR MODEL PARAMETERS.

PARAMETER	DEFAULT	DESCRIPTION
I_S	10^{-15} A/m^2	Saturation current
I_{SC}	0 A/m^2	Base-collector leakage saturation current
I_{SE}	0 A/m^2	Base-emitter leakage saturation current
M_{JC}	1/3	Base-collector grading coefficient
M_{JE}	1/3	Base-emitter grading coefficient
N_C	2	Base-collector ideality factor
N_E	1.4	Base-emitter ideality factor
N_F	1	Forward ideality factor
N_R	1	Reverse ideality factor
R_B	$0 \Omega\text{-m}^2$	Base resistance
R_{BM}	$0 \Omega\text{-m}^2$	Minimum base resistance
R_C	$0 \Omega\text{-m}^2$	Collector resistance
R_E	$0 \Omega\text{-m}^2$	Emitter resistance
T_{NOM}	298.15 K	Device temperature
V_{AF}	Inf (V)	Forward Early voltage
V_{AR}	Inf (V)	Reverse Early voltage
V_{JC}	0.71 V	Base-collector built-in potential
V_{JE}	0.71 V	Base-emitter built-in potential

MOSFET Transistors

Figure 5-2 illustrates an equivalent circuit for the n-channel MOSFET transistor. The p-channel MOSFET transistor is treated similarly, but the polarities of the involved voltages are reversed.

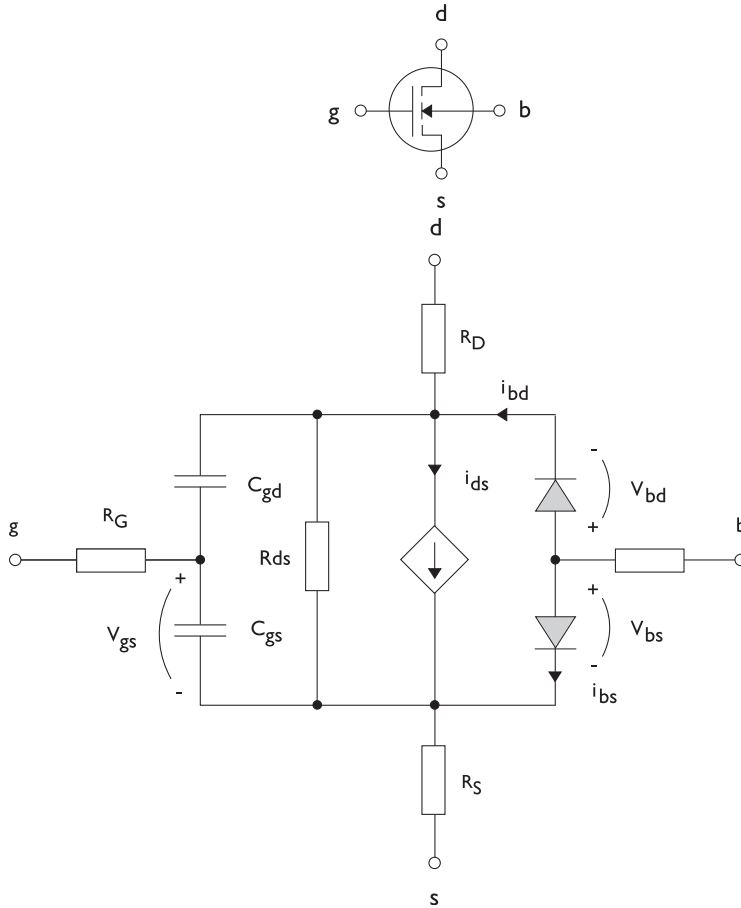

Figure 5-2: A circuit for the MOSFET transistor.

The following equations are used to compute the relations between currents and voltages in the circuit.

$$i_{ds} = \begin{cases} \frac{WK_P}{L} \frac{1}{2} (1 + \Lambda v_{ds}) v_{ds} (2v_{th} - v_{ds}) & v_{ds} < v_{th} \\ \frac{WK_P}{L} \frac{1}{2} (1 + \Lambda v_{ds}) v_{th}^2 & v_{ds} \geq v_{th} \\ 0 & v_{ds} < v_{th} \leq 0 \end{cases}$$

$$v_{th} = v_{gs} - (V_{TO} + \Gamma(\sqrt{\Phi} - v_{bs} - \sqrt{\Phi}))$$

$$i_{bd} = I_S \left(e^{\frac{v_{bd}}{NV_T}} - 1 \right)$$

$$i_{bs} = I_S \left(e^{\frac{v_{bs}}{NV_T}} - 1 \right)$$

$$V_T = \frac{k_B T_{NOM}}{q}$$

There are also several capacitances between the terminals

$$C_{gd} = C_{gd0} W$$

$$C_{gs} = C_{gs0} W$$

$$C_{jbd} = C_{BD} \times \begin{cases} \left(1 - \frac{v_{bd}}{P_B}\right)^{-M_J} & v_{bx} < F_C P_B \\ (1 - F_C)^{-1 - M_J} \left(1 - F_C(1 + M_J) + M_J \frac{v_{bx}}{P_B}\right) & v_{bx} \geq F_C P_B \end{cases}$$

The model parameters are as follows:

TABLE 5-2: MOSFET TRANSISTOR MODEL PARAMETERS.

PARAMETER	DEFAULT	DESCRIPTION
C_{BD}	0 F/m	Bulk-drain zero-bias capacitance
C_{GDO}	0 F/m	Gate-drain overlap capacitance
C_{GSO}	0 F/m	Gate-source overlap capacitance
F_C	0.5	Capacitance factor
I_S	1e-13 A	Bulk junction saturation current
K_P	2e-5 A/V ²	Transconductance parameter
L	50e-6 m	Gate length
M_J	0.5	Bulk junction grading coefficient

TABLE 5-2: MOSFET TRANSISTOR MODEL PARAMETERS.

PARAMETER	DEFAULT	DESCRIPTION
N	1	Bulk junction ideality factor
P_B	0.75 V	Bulk junction potential
R_B	0 Ω	Bulk resistance
R_D	0 Ω	Drain resistance
R_{DS}	Inf (Ω)	Drain-source resistance
R_G	0 Ω	Gate resistance
R_S	0 Ω	Source resistance
T_{NOM}	298.15 K	Device temperature
V_{TO}	0 V	Zero-bias threshold voltage
W	50e-6 m	Gate width
Γ (GAMMA)	1 $\text{V}^{0.5}$	Bulk threshold parameter
Φ (PHI)	0.5 V	Surface potential
Λ (LAMBDA)	0 1/V	Channel-length modulation

Diode

Figure 5-3 illustrates equivalent circuit for the diode.

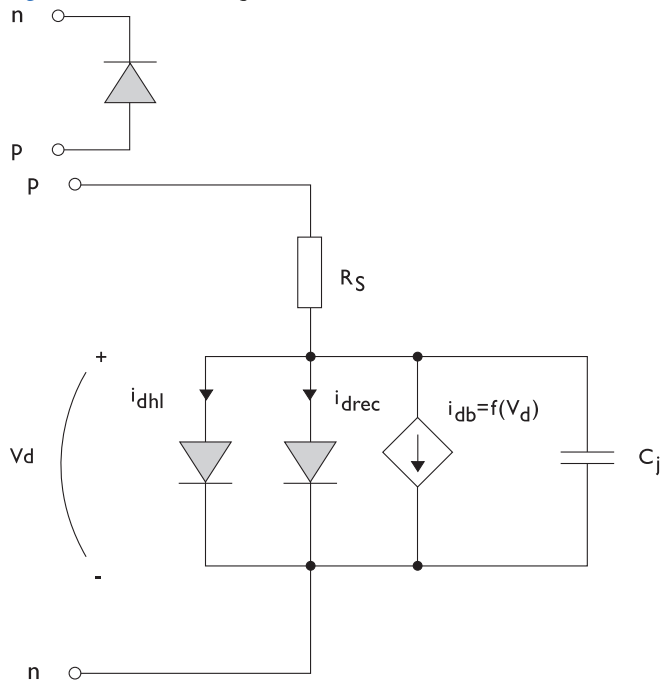

Figure 5-3: A circuit for the diode.

The following equations are used to compute the relations between currents and voltages in the circuit.

$$i_d = i_{dhl} + i_{drec} + i_{db} + i_c$$

$$i_{dhl} = I_S \left(e^{\frac{v_d}{N V_T}} - 1 \right) \frac{1}{\sqrt{1 + \frac{I_S}{I_{KF}} \left(e^{\frac{v_d}{N V_T}} - 1 \right)}}$$

$$i_{drec} = I_{SR} \left(e^{\frac{v_d}{N_R V_T}} - 1 \right)$$

$$i_{db} = I_{BV} e^{\frac{v_d + B_V}{N_{BV} V_T}}$$

$$C_j = C_{J0} \times \begin{cases} \left(1 - \frac{v_d}{V_J} \right)^{-M} & v_d < F_C V_J \\ (1 - F_C)^{-1-M} \left(1 - F_C (1 + M) + M \frac{v_d}{V_J} \right) & v_d \geq F_C V_J \end{cases}$$

$$V_T = \frac{k_B T_{NOM}}{q}$$

where the following model parameters are required.

TABLE 5-3: DIODE TRANSISTOR MODEL PARAMETERS.

PARAMETER	DEFAULT	DESCRIPTION
B_V	Inf (V)	Reverse breakdown voltage
C_{J0}	0 F	Zero-bias junction capacitance
F_C	0.5	Forward-bias capacitance coefficient
I_{BV}	1 e-09 A	Current at breakdown voltage
I_{KF}	Inf (A)	Corner for high-current roll-off
I_S	1 e-13 A	Saturation current
M	0.5	Grading coefficient
N	1	Ideality factor
N_{BV}	1	Breakdown ideality factor
N_R	2	Recombination ideality factor
R_S	0 Ω	Series resistance
T_{NOM}	298.15 K	Device temperature
V_J	1.0 V	Junction potential

Reference for the Electrical Circuit Interface

I. P. Antognetti and G. Massobrio, *Semiconductor Device Modeling with Spice*, 2nd ed., McGraw Hill, 1993.

Chemical Species Transport Interfaces



This chapter describes the physics interfaces found under the **Chemical Species Transport** branch ()

In this chapter:

- [The Transport of Diluted Species Interface](#)
- [The Transport of Diluted Species in Porous Media Interface](#)
- [The Transport of Diluted Species in Fractures Interface](#)
- [The Transport of Concentrated Species Interface](#)
- [The Transport of Concentrated Species in Porous Media Interface](#)
- [The Chemistry Interface](#)
- [The Nernst–Planck–Poisson Equations Interface](#)
- [The Electrophoretic Transport Interface](#)
- [The Surface Reactions Interface](#)
- [The Reacting Flow Interfaces](#)
- [The Reacting Flow in Porous Media Interfaces](#)
- [The Nonisothermal Reacting Flow Multiphysics Interfaces](#)

The theory for all the interfaces is also discussed at the end of the chapter and links are included with the interfaces.

The Transport of Diluted Species Interface

The **Transport of Diluted Species (tds)** interface () , found under the **Chemical Species Transport** branch () , is used to calculate the concentration field of a dilute solute in a solvent. Transport and reactions of the species dissolved in a gas, liquid, or solid can be handled with this interface. The driving forces for transport can be diffusion by Fick's law, convection when coupled to a flow field, and migration, when coupled to an electric field.

The interface supports simulation of transport by convection and diffusion in 1D, 2D, and 3D as well as for axisymmetric components in 1D and 2D. The dependent variable is the molar concentration, c . Modeling multiple species transport is possible, whereby the physics interface solves for the molar concentration, c_i , of each species i .

SETTINGS

The **Label** is the default physics interface name.

The **Name** is used primarily as a scope prefix for variables defined by the physics interface. Refer to such physics interface variables in expressions using the pattern `<name>.<variable_name>`. In order to distinguish between variables belonging to different physics interfaces, the `name` string must be unique. Only letters, numbers, and underscores (`_`) are permitted in the **Name** field. The first character must be a letter.

The default **Name** (for the first physics interface in the model) is `tds`.

DOMAIN SELECTION

If any part of the model geometry should not partake in the mass transfer model, remove that part from the selection list.

OUT-OF-PLANE THICKNESS

For 2D components, the **Thickness** field (default value: 1 m) defines a parameter for the thickness of the geometry perpendicular to the two-dimensional cross-section. Both constant and varying thicknesses are supported. The value of this parameter is used, among other things, to automatically calculate molar flow rates from the total molar flux.

CROSS-SECTIONAL AREA

For 1D components, enter a **Cross-sectional area** A_c (SI unit: m^2) to define a parameter for the area of the geometry perpendicular to the 1D component. Both constant and varying areas are supported. The value of this parameter is used, among other things, to automatically calculate molar flow rates from the total molar flux. The default is 1 m^2 .

TRANSPORT MECHANISMS

Mass transport due to diffusion is always included. Use the check boxes available under **Additional transport mechanisms** to control other transport mechanisms.

Note: Some of the additional transport mechanisms listed below are only available in certain products. For details see <https://www.comsol.com/products/specifications/>.

- By default, the **Convection** check box is selected. Clear the check box to disable convective transport.
- Select the **Migration in electric field** check box to activate transport of ionic species in an electric field. See further the theory section [Adding Transport Through Migration](#).



Transport of ionic species in an electric field is available in a limited set of add-on products. See <https://www.comsol.com/products/specifications/> for more details on availability.

Mass Transport in Porous Media

The **Mass transport in porous media** check box activates functionality specific to species transport in porous media:

- [Porous Medium](#)
- [Unsaturated Porous Medium](#)
- [Porous Electrode Coupling](#)
- [Volatilization](#)
- [Species Source](#)



Note: Mass transport in porous media is only available in a limited set of add-on products. See <https://www.comsol.com/products/specifications/> for more details on availability.

CONSISTENT STABILIZATION

To display this sections, click the **Show** button () and select **Stabilization**.

- When the **Crosswind diffusion** check box is selected, a weak term that reduces spurious oscillations is added to the transport equation. The resulting equation system is always nonlinear. There are two options for the **Crosswind diffusion type**:
 - **Do Carmo and Galeão** — the default option. This type of crosswind diffusion reduces undershoots and overshoots to a minimum but can in rare cases give equation systems that are difficult to fully converge.
 - **Codina** — this option is less diffusive compared to the Do Carmo and Galeão option but can result in more undershoots and overshoots. It is also less effective for anisotropic meshes. The Codina option activates a text field for the **Lower gradient limit** g_{lim} . Its defaults to $0.1 [mol/m^3] / tds.helem$, where $tds.helem$ is the local element size.
- For both consistent stabilization methods, select an **Equation residual**. **Approximate residual** is the default and means that derivatives of the diffusion tensor components are neglected. This setting is usually accurate enough and is computationally faster. If required, select **Full residual** instead.

INCONSISTENT STABILIZATION

To display this section, click the **Show** button () and select **Stabilization**. By default, the **Isotropic diffusion** check box is not selected, because this type of stabilization adds artificial diffusion and affects the accuracy of the original problem. However, this option can be used to get a good initial guess for under resolved problems.

ADVANCED SETTINGS

To display this section, click the **Show** button () and select **Advanced Physics Options**. Normally these settings do not need to be changed. Select a **Convective term** — **Nonconservative form** (the default) or **Conservative form**. The conservative formulation should be used for compressible flow. See [Convective Term Formulation](#) for more information.

DISCRETIZATION

To display all settings available in this section, click the **Show** button () and select **Advanced Physics Options**.

The **Compute boundary fluxes** check box is activated by default so that COMSOL Multiphysics computes predefined accurate boundary flux variables. When this option

is selected, the solver computes variables storing accurate boundary fluxes from each boundary into the adjacent domain.

If the check box is cleared, the COMSOL Multiphysics software instead computes the flux variables from the dependent variables using extrapolation, which is less accurate in postprocessing results but does not create extra dependent variables on the boundaries for the fluxes.

The flux variables affected in the interface are:

- `ndflux_c` (where c is the dependent variable for the concentration). This is the normal diffusive flux and corresponds to the boundary flux when diffusion is the only contribution to the flux term.
- `ntflux_c` (where c is the dependent variable for the concentration). This is the normal total flux and corresponds to the boundary flux plus additional transport terms, for example, the convective flux when you use the nonconservative form.

Also the **Apply smoothing to boundary fluxes** check box is available if the previous check box is selected. The smoothing can provide a more well-behaved flux value close to singularities.



For details about the boundary fluxes settings, see [Computing Accurate Fluxes](#) in the *COMSOL Multiphysics Reference Manual*.

The **Value type when using splitting of complex variables** setting should in most pure mass transfer problems be set to **Real**, which is the default. It makes sure that the dependent variable does not get affected by small imaginary contributions, which can occur, for example, when combining a Time Dependent or Stationary study with a frequency-domain study. For more information, see [Splitting Complex-Valued Variables](#) in the *COMSOL Multiphysics Reference Manual*.



DEPENDENT VARIABLES

The dependent variable name is the **Concentration c** by default. The names must be unique with respect to all other dependent variables in the component.



Add or remove species variables in the model and also change the names of the dependent variables that represent the species concentrations.

Enter the **Number of species**. Use the **Add concentration** () and **Remove concentration** () buttons as needed.

FURTHER READING

	<ul style="list-style-type: none">• Theory for the Transport of Diluted Species Interface• Numerical Stabilization in the <i>COMSOL Multiphysics Reference Manual</i>.• In the <i>COMSOL Multiphysics Reference Manual</i>, see Table 2-4 for links to common sections and Table 2-5 for common feature nodes. You can also search for information: press F1 to open the Help window or Ctrl+F1 to open the Documentation window.
	<ul style="list-style-type: none">• <i>Effective Diffusivity in Porous Materials</i>: Application Library path COMSOL_Multiphysics/Diffusion/effective_diffusivity• <i>Micromixer</i>: Application Library path COMSOL_Multiphysics/Fluid_Dynamics/micromixer

The Transport of Diluted Species in Porous Media Interface

This interface () , found under the **Chemical Species Transport** branch () , is used to calculate the species concentration and transport in free and porous media. The interface is the same as the *Transport of Diluted Species* interface but it uses other defaults: The [Mass Transport in Porous Media](#) property is selected, and a [Porous Medium](#) node is added by default. The interface includes reaction rate expressions and solute sources for modeling of species transport and reaction in porous media.

This interface is dedicated to modeling transport in porous media, including immobile and mobile phases, where the chemical species may be subjected to diffusion, convection, migration, dispersion, adsorption, and volatilization in porous media. It supports cases where either the solid phase substrate is exclusively immobile, or when a gas-filling medium is also assumed to be immobile.

It applies to one or more diluted species or solutes that move primarily within a fluid that fills (saturated) or partially fills (unsaturated) the voids in a solid porous medium. The pore space not filled with fluid contains an immobile gas phase. Models including a combination of porous media types can be studied.

The main feature nodes are the **Porous Medium** and **Unsaturated Porous Medium** nodes, which add the equations for the species concentrations and provide an interface for defining the properties of the porous media, as well as additional properties governing

adsorption, volatilization, dispersion and diffusion, migration, and the velocity field to model convection.



The physics interface can be used for stationary and time-dependent analysis.

When this physics interface is added, these default nodes are also added to the **Model Builder** — **Porous Medium, No Flux** (the default boundary condition), and **Initial Values**. Then, from the **Physics** toolbar, add other nodes that implement, for example, boundary conditions, reaction rate expressions, and species sources. You can also right-click **Transport of Diluted Species in Porous Media** to select physics features from the context menu.

SETTINGS

The rest of the settings are the same as [The Transport of Diluted Species Interface](#).

FURTHER READING

	<ul style="list-style-type: none">• Mass Balance Equation for Transport of Diluted Species in Porous Media• Domain, Boundary, and Pair Nodes for the Transport of Diluted Species Interface
	<ul style="list-style-type: none">• <i>Variably Saturated Flow and Transport — Sorbing Solute:</i> Application Library path Subsurface_Flow_Module/Solute_Transport/sorbing_solute Web link: https://www.comsol.com/model/variably-saturated-flow-and-transport-8212-sorbing-solute-490

Domain, Boundary, and Pair Nodes for the Transport of Diluted Species Interface

[The Transport of Diluted Species Interface](#) has the following domain, boundary, point, and pair nodes, listed in alphabetical order, available from the **Physics** ribbon toolbar

(Windows users), **Physics** context menu (Mac or Linux users), or by right-clicking to access the context menu (all users).



- To add a node, go to the **Physics** toolbar, no matter what operating system you are using.
 - Contextual subnodes (attributes) are available by clicking the parent node in the Model Builder, and then selecting the subnode from the **Attributes** menu.
-

- Adsorption
- Concentration
- Continuity on Interior Boundaries
- Dispersion
- Electrode Surface Coupling
- Equilibrium Reaction
- Fast Irreversible Surface Reaction
- Fluid
- Flux
- Flux Discontinuity
- Fracture
- Gas
- Inflow
- Initial Values
- Line Mass Source
- Liquid
- Mass-Based Concentrations
- No Flux
- Open Boundary
- Out-of-Plane Flux
- Outflow
- Partition Condition
- Periodic Condition
- Point Mass Source
- Porous Matrix
- Porous Medium
- Porous Electrode Coupling
- Reaction Coefficients
- Reactions
- Solid
- Species Properties
- Species Source
- Surface Reactions
- Surface Equilibrium Reaction
- Symmetry
- Thin Diffusion Barrier
- Thin Impermeable Barrier
- Transport Properties
- Unsaturated Porous Medium
- Volatilization

Some features require certain add-on modules. For details see <https://www.comsol.com/products/specifications/>



For axisymmetric components, COMSOL Multiphysics takes the axial symmetry boundaries (at $r = 0$) into account and automatically adds an **Axial Symmetry** node that is valid on boundaries representing the symmetry axis.



In the *COMSOL Multiphysics Reference Manual*, see [Table 2-4](#) for links to common sections and [Table 2-5](#) for common feature nodes. You can also search for information: press F1 to open the **Help** window or Ctrl+F1 to open the **Documentation** window.

Prescribing Conditions on Fluid-Solid Interfaces

Defining conditions on interfaces between different phases, typically a wall in contact with a fluid, it is worthwhile to be careful with how variables in the conditions are evaluated. COMSOL Multiphysics supports that variables are defined differently on adjacent domains (or any other geometry dimension). Evaluating a variable with differing definitions, the mean value is returned on a boundary separating the different domains. The density, pressure, or temperature are examples of variables that may differ in a fluid and a solid. In order to specify on which side a variable is evaluated, the [up and down](#) operators (described in the *COMSOL Multiphysics Reference Manual*) can be used.

Species Properties

Use this node to define parameters specific to each of the species. It is available when the **Migration in electric field** check box is selected in the [Transport Mechanisms](#) section of the interface.

The node will change its label depending on what inputs are available in the node. If only **Charge** is available, it will be labeled “Species charges”.

CHARGE

Enter the charge number z_c (dimensionless, but requires a plus or minus sign) for each species.

ACTIVITY

This section is available when the **Species Activity** combo box is set to **Debye-Hückel** or **User defined**.

If **Debye-Hückel** is selected, enter the ion size number, a_0 , for each species. If **User defined** is selected, enter the activity coefficient, f , for each species.

Transport Properties

The settings in this node are dependent on the check boxes selected under **Transport Mechanisms** in the **Settings** window for the Transport of Diluted Species interface. It includes only the sections required by the activated transport mechanisms. It has all the equations defining transport of diluted species as well as inputs for the material properties.

MODEL INPUTS

The temperature model input is always available. Select the source of the **Temperature**. For **User defined**, enter a value or expression for the temperature in the input field. This input option is always available.

You can also select the temperature solved for by a Heat Transfer interface added to the model component. These physics interfaces are available for selection in the **Temperature** list.

CONVECTION

If transport by convection is active, the velocity field of the solvent needs to be specified. Select the source of the **Velocity field**. For **User defined**, enter values or expressions for the velocity components in the input fields. This input option is always available.

You can also select the velocity field solved for by a Fluid Flow interface added to the model component. These physics interfaces are available for selection in the **Velocity field** list.

DIFFUSION

Use this section to specify diffusion coefficients describing the diffusion of each species in the solvent fluid.

Use the **Source** list to select to pick up diffusion coefficients defined in a material or a Chemistry interface.

Select **Material**, and a **Fluid material** to use a diffusion coefficient in a material available in the model. User-defined property groups including a diffusion coefficient output property are available for selection in the **Fluid diffusion coefficient** list.

Select **Chemistry** to use a diffusion coefficient from a Chemistry interface added to model component. Diffusion coefficients are automatically defined when **Calculate transport properties** is selected on the interface level of a Chemistry interface. All

defined diffusion coefficients are available for selection in the **Fluid diffusion coefficient** list.

For **User defined**, enter a value or expression for the **Fluid diffusion coefficient** D_c of each species in the corresponding input field. This can be a scalar value for isotropic diffusion or a tensor describing anisotropic diffusion. Select the appropriate tensor type — **Isotropic**, **Diagonal**, **Symmetric**, or **Full** that describes the diffusion transport, and then enter the values in the corresponding element (one value for each species).

Note that multiple species, as well as Migration in Electric fields (described below) is only available for certain COMSOL Multiphysics add-on products. See details: <https://www.comsol.com/products/specifications/>.

MIGRATION IN ELECTRIC FIELD

This section is available when the **Migration in electric field** check box is selected. From the **Electric potential** list, select the source of the electric field.

- Enter a value or expression for the **Electric potential** V , which is **User defined**; this input option is always available.
- Select the electric potential solved by an AC/DC-based interface that has also been added to the model.
- Select the electric potential defined or solved by Electrochemistry interface that has been added to the component.



By default the **Mobility** is set to be calculated based on the species diffusivity and the temperature using the **Nernst-Einstein relation**. For **User defined**, and under **Mobility**, select the appropriate scalar or tensor type — **Isotropic**, **Diagonal**, **Symmetric**, or **Full** — and type in the value of expression of the mobility $u_{m,c}$.

Enter the **Charge number** z_c (dimensionless, but requires a plus or minus sign) for each species.

The temperature (if you are using mobilities based on the Nernst–Einstein relation) is taken from **Model Inputs** section.

Note that the migration in electric fields feature is only available in some COMSOL products. See details: <https://www.comsol.com/products/specifications/>.

EXAMPLE MODELS

	<ul style="list-style-type: none">• <i>Separation Through Dialysis</i>: Application Library path Chemical_Reaction_Engineering_Module/Mixing_and_Separation/dialysis Web link: https://www.comsol.com/model/separation-through-dialysis-258
	<ul style="list-style-type: none">• <i>Transport in an Electrokinetic Valve</i>: Application Library path Microfluidics_Module/Fluid_Flow/electrokinetic_valve Web link: https://www.comsol.com/model/transport-in-an-electrokinetic-valve-603

Solid

Use this node to describe diffusion in a solid phase domain. In this feature, the activities of the species are assumed to be ideal.

DIFFUSION

Specify the diffusion coefficients describing the diffusion of each species in the solid.

Enter a value or expression for the **Diffusion coefficient** D_c of each species in the corresponding input field. This can be a scalar value for isotropic diffusion or a tensor describing anisotropic diffusion. Select the appropriate tensor type — **Isotropic**, **Diagonal**, or **Symmetric** that describes the diffusion transport, and then enter the values in the corresponding element (one value for each species).

ADVANCED

This section is only available with the **Advanced Physics Options** selected and when the model contains a split between the material frame and the spatial frame. A split of these frames occurs when using a **Moving Mesh** node or a Structural Mechanics interface like **Solid Mechanics**. In such a model, the reference geometry (the material frame) differs from the deformed geometry (the spatial frame). The diffusive transport of species is solved for on the material frame, but the equation is adjusted for geometry deformations so that species conservation is achieved on the spatial frame. Use the **Diffusion model** to define the frame of reference for the diffusion tensor.

Select **Reference geometry based (Lagrangian)** to specify the diffusion tensor in the undeformed geometry, implying that the diffusion is defined in the material frame

(indicated by coordinates X, Y, Z). This is the preferred setting for an anisotropic diffusion in combination with solid body translation or rotation. Also in general when the diffusion tensor components have been measured in an undeformed geometry.

Select **Deformed geometry based (Eulerian)** to specify the diffusion tensor in the deformed geometry. This means that the diffusion is defined in the spatial frame (indicated by coordinates x, y, z). Use this setting when the diffusion tensor components have been measured in a deformed geometry.

The **Advanced Physics Options** is found in the **Show More Options** dialog box, accessed by clicking the **Show More Options** button ().

Note that multiple species are only available for certain COMSOL Multiphysics add-on products. See details: <https://www.comsol.com/products/specifications/>.

Initial Values

The **Initial Values** node specifies the initial values for the concentration of each species. These serve as an initial guess for a stationary solver or as initial conditions for a transient simulation.

DOMAIN SELECTION

If there are several types of domains with different initial values defined, it might be necessary to remove some domains from the selection. These are then defined in an additional **Initial Values** node.

INITIAL VALUES

Enter a value or expression for the initial value of the **Concentration** or concentrations, c_i . This also serves as a starting guess for stationary problems.

Mass-Based Concentrations

Use the **Mass-Based Concentrations** node to add postprocessing variables for mass-based concentrations (SI unit: kg/m^3) and mass fractions (dimensionless) for all species.

MIXTURE PROPERTIES

The default **Solvent density** ρ_{solvent} is taken **From material**. For **User defined**, enter a value or expression manually. Define the **Molar mass** of each species, which is needed to calculate the mass-based concentration.

Reactions

Use the **Reactions** node to account for the consumption or production of species through chemical reactions. Define the rate expressions as required.

DOMAIN SELECTION

From the **Selection** list, choose the domains on which to define rate expression or expressions that govern the source term in the transport equations.

Several reaction nodes can be used to account for different reactions in different parts for the modeling geometry.

REACTION RATES

Add a rate expression R_i (SI unit: $\text{mol}/(\text{m}^3 \cdot \text{s})$) for species i . Enter a value or expression in the field. Note that if you have the *Chemistry* interface available, provided with the *Chemical Reaction Engineering Module*, the reaction rate expressions can be automatically generated and picked up using the drop-down list. For an example, see the application *Fine Chemical Production in a Plate Reactor* as linked below.

REACTING VOLUME

This section is only available when the [Mass Transport in Porous Media](#) property is available and selected. See <https://www.comsol.com/products/specifications/> for more details on availability.

When specifying reaction rates for a species in porous media, the specified reaction rate may have the basis of the total volume, the pore volume, or in the case of using the volume of a particular phase (applicable when modeling an unsaturated porous medium).

- For **Total volume**, the reaction expressions, in $\text{mol}/(\text{m}^3 \cdot \text{s})$, are specified per unit volume of the model domain (multiplied by unity).
- For **Pore volume**, the reaction expressions, in $\text{mol}/(\text{m}^3 \cdot \text{s})$, are specified per unit volume of total pore space. The reaction expressions will be multiplied by the domain porosity, ε_p . (ε_p equals unity for nonporous domains).
- For **Liquid phase**, the reaction expressions, in $\text{mol}/(\text{m}^3 \cdot \text{s})$, are specified per unit volume of liquid in the pore space. The expressions will be multiplied by the liquid volume fraction θ_l . (θ_l equals the porosity (ε_p) on Porous Medium domains).
- For **Gas phase**, the reaction expressions, in $\text{mol}/(\text{m}^3 \cdot \text{s})$, are multiplied by the gas volume fraction $\theta_g = \varepsilon_p - \theta_l$. θ_g equals 0 for Porous Medium domains.

FURTHER READING

See the theory chapter on chemical species transport, starting with the section *Mass Balance Equation*.



- *Fine Chemical Production in a Plate Reactor*: Application Library path **Chemical_Reaction_Engineering_Module/Reactors_with_Mass_and_Heat_Transfer/plate_reactor**

Web link: <https://www.comsol.com/model/fine-chemical-production-in-a-plate-reactor-8589>

No Flux

This node is the default boundary condition on exterior boundaries. It should be used on boundaries across which there is no mass flux, typically solid walls where no surface reactions occur. The condition applied for each species corresponds to

$$-\mathbf{n} \cdot (-D\nabla c) = 0$$

where \mathbf{n} denotes the outward pointing normal of the boundary. When the mass transport includes migration of ionic species, the no flux condition is:

$$-\mathbf{n} \cdot (-D\nabla c - zu_m Fc\nabla\phi) = 0$$

CONVECTION

By default, the feature prescribes a vanishing flux due to diffusion and migration in an electric field. This is the appropriate no flux condition when the relative convective velocity at the boundary is zero. When the fluid velocity at the boundary is not equal to that of the boundary, it is often convenient to prescribe the total flux including the convection. To do this select **Include** in the **Convection** section.

When including the convection, the no flux condition prescribed is

$$-\mathbf{n} \cdot (-D\nabla c + \mathbf{u}c) = 0$$

or

$$-\mathbf{n} \cdot (-D\nabla c - zu_m Fc\nabla\phi + \mathbf{u}c) = 0$$

when migration of ionic species is included.

Inflow

Use this node to specify all species concentrations at an inlet boundary.

If you want to specify the concentration of a subset of the partaking species, this can be done by using the [Concentration](#) node instead.

For the **Electroanalysis** interface, this node is available when you select the **Convection** check box on the physics interface **Settings** window.

CONCENTRATION

For the concentration of each species $c_{0,c}$ (SI unit: mol/m³), enter a value or expression.

BOUNDARY CONDITION TYPE

The option **Concentration constraint** constrains the concentration values on the boundary by the use of pointwise constraints.

The other option, **Flux (Danckwerts)** can be used when the concentration at the boundary is not known, or when it varies in a nontrivial manner. This may, for example, be useful when reactions with high reaction rates occur in the vicinity of the inlet. In this case the concentration far upstream of the boundary is instead prescribed. The **Flux (Danckwerts)** condition prescribes the total flux defined by the upstream concentration and the fluid velocity at the boundary.

CONSTRAINT SETTINGS

To display this section, click the **Show More Options** button () and select **Advanced Physics Options**. You can find details about the different constraint settings in the section [Constraint Reaction Terms](#) in the *COMSOL Multiphysics Reference Manual*.

FURTHER READING

See the theory chapter in the section [Danckwerts Inflow Boundary Condition](#).

Outflow

Apply this condition at outlets boundaries where species should be transported out of the model domain by fluid motion or by an electric field (in the case of ions). It is assumed that convection and migration (in an electric field) are the dominating transport mechanisms across the boundary, and therefore that the diffusive transport can be ignored, that is:

$$\mathbf{n} \cdot (-D\nabla c) = 0$$

Note that the **Convection** or the **Migration in electric field** transport mechanisms needs to be included for this node to be available.

Concentration

This condition node adds a boundary condition for the species concentration. For example, a $c = c_0$ condition specifies the concentration of species c .

CONCENTRATION

Individually specify the concentration for each species. Select the check box for the **Species** to specify the concentration, and then enter a value or expression in the corresponding field. To use another boundary condition for a specific species, click to clear the check box for the concentration of that species.

When defining conditions on boundaries between different phases, see the section [Prescribing Conditions on Fluid-Solid Interfaces](#).

CONSTRAINT SETTINGS

To display this section, click the **Show** button () and select **Advanced Physics Options**. You can find details about the different constraint settings in the section [Constraint Reaction Terms](#) in the *COMSOL Multiphysics Reference Manual*.

Flux

This node can be used to specify the species molar flux across a boundary. The flux can for example occur due to chemical reactions or a phase change at the boundary. The flux can also represent the transport to or from a surrounding environment currently not included model.

The prescribed flux of a species c is by default defined as

$$-\mathbf{n} \cdot (-D\nabla c) = J_0$$

where \mathbf{n} denotes the outward pointing normal of the boundary. When the mass transport includes migration of ionic species, the flux is defined as:

$$-\mathbf{n} \cdot (-D\nabla c - zu_m Fc\nabla\phi) = J_0$$

The flux prescribed, J_0 , can include any arbitrary user-specified expression. It can be constant or a function of a dependent variable or independent variable. Common examples are a flux dependent of the concentration, temperature, pressure, or the electric potential ϕ .

When defining conditions on boundaries between different phases, see the section [Prescribing Conditions on Fluid-Solid Interfaces](#).

CONVECTION

By default, the flux due to diffusion and migration in an electric field is prescribed. This is the appropriate flux condition when the relative velocity at the boundary is zero. When the fluid velocity is not equal to that of the boundary, it is often convenient to prescribe the total flux, including the convection. To do this select **Include** in the **Convection** section.

When including the convection, the prescribed flux is defined as:

$$-\mathbf{n} \cdot (-D\nabla c + \mathbf{u}c) = J_0$$

or

$$-\mathbf{n} \cdot (-D\nabla c - zu_m Fc\nabla\phi + \mathbf{u}c) = J_0$$

when migration of ionic species is included.

INWARD FLUX

Select the Species check box for the species for which to specify the flux, and enter a value or expression for the inward flux in the corresponding field. Use a minus sign when specifying a flux directed out of the system. To use another boundary condition for a specific species, click to clear the check box for that species.

External convection

Set **Flux type** to **External convection** to prescribe a flux to or from an exterior domain (not modeled) assumed to include convection. The exterior can for example include a forced convection to control the temperature or to increase the mass transport. In this case the prescribed mass flux corresponds to

$$J_0 = k_c(c_b - c)$$

where k_c is a mass transfer coefficient and c_b is the bulk concentration, the typical concentration far into the surrounding exterior domain.

Symmetry

The **Symmetry** node can be used to represent boundaries where the species concentration is symmetric, that is, where there is no mass flux across the boundary.

This boundary condition is identical to that of the **No Flux** node.

Flux Discontinuity

This node represents a discontinuity in the mass flux across an interior boundary:

$$-\mathbf{n} \cdot [(\mathbf{J} + \mathbf{uc})_{\text{u}} - (\mathbf{J} + \mathbf{uc})_{\text{d}}] = N_0 \quad \mathbf{J} = -D\nabla c - z\mathbf{u}_{\text{m}}Fc\nabla\phi$$

where the value N_0 (SI unit: mol/(m²·s)) specifies the jump in total flux at the boundary. This can be used to model a boundary source, for example a surface reaction, adsorption, or desorption.

FLUX DISCONTINUITY

In this section the jump in species flux (or surface source) is specified.

Select the Species check box for the species to specify and enter a value or expression for the material flux jump in the corresponding field. To use a different boundary condition for a specific species, click to clear the check box for the flux discontinuity of that species.

Partition Condition

The **Partition Condition** node can be used to prescribe the relation between the concentration of a solute species in two adjoining immiscible phases. It can for example be used on interior boundaries separating two liquid phases, a gas-liquid interface, or on a boundary separating a liquid phase and a solid or porous media.

Select **Partition coefficient** from the **Relation** list to prescribe a linear relationship between the concentration on either side of a boundary. For a species concentration c_i , the ratio between the concentration on the upside and on the downside of the boundary ($c_{i,\text{u}}$ and $c_{i,\text{d}}$ respectively) is then defined in terms of a partition coefficient K_i in the manner of

$$K_i = \frac{c_{i,\text{u}}}{c_{i,\text{d}}}$$

Use the associated input field to prescribe the partition coefficient for each species.

Select **User defined** from the **Relation** list to set up a nonlinear relation between the up and downside concentrations. For such relations $f(c_i)_u=f(c_i)_d$, where $f(c_i)_u$ is the expression enforced on the upside. Use the associated input fields to enter the upside and downside expressions for each species.

The up and downside of the selected boundary is indicated with a red arrow in the Graphics window. The arrow points from the downside into the upside. Select the **Reverse direction** check box to reverse the direction of the arrow on the selected boundary, and update the definition of the up and downside concentrations accordingly.



This feature is only available in a limited set of add-on products. See <https://www.comsol.com/products/specifications/> for more details on availability.

FURTHER READING

For an example of using a partition condition, see this application example:



Separation Through Dialysis: Application Library path
Chemical_Reaction_Engineering_Module/Mixing_and_Separation/dialysis

Periodic Condition

The **Periodic Condition** node can be used to define periodicity for the mass transport between two sets of boundaries. The node prescribes continuity in the concentration and the mass flux between the “source” and the “destination” side, respectively. Note that these names are arbitrary and does not influence the direction in which mass is transported. It is dictated by mass transfer equations in the adjacent domains.

BOUNDARY SELECTION

The node can be activated on more than two boundaries, in which case the feature tries to identify two separate surfaces that each consist of one or several connected boundaries.

DESTINATION SELECTION

For more complex geometries, it might be necessary to specify the destination selection manually. To do so, right-click the **Periodic Condition** node and choose **Manual**

Destination Selection. You can then specify the boundaries that constitute the destination surfaces in the **Destination Selection** section.

CONSTRAINT SETTINGS

To display this section, click the **Show More Options** button () and select **Advanced Physics Options** in the **Show More Options** dialog box. This section contains settings for specifying the type of constraint and whether to use a pointwise or weak constraint. See [Constraint Settings](#) in the *COMSOL Multiphysics Reference Manual* for more information.

ORIENTATION OF SOURCE

To display this section, click the **Show More Options** button () and select **Advanced Physics Options** in the **Show More Options** dialog box. For information about the **Orientation of Source** section, see [Orientation of Source and Destination](#) in the *COMSOL Multiphysics Reference Manual*.

ORIENTATION OF DESTINATION

This section appears if the setting for **Transform to intermediate map** in the **Orientation of Source** section is changed from the default value, **Automatic**, and **Advanced Physics Options** is selected in the **Show More Options** dialog box. For information about the **Orientation of Destination** section, see [Orientation of Source and Destination](#) in the *COMSOL Multiphysics Reference Manual*.

MAPPING BETWEEN SOURCE AND DESTINATION

To display this section, click the **Show More Options** button () and select **Advanced Physics Options** in the **Show More Options** dialog box. For information about the **Mapping Between Source and Destination** section, see [Mapping Between Source and Destination](#) in the *COMSOL Multiphysics Reference Manual*.

FURTHER READING

For an example of using a periodic condition, see this application example:



The KdV Equation and Solitons: Application Library path
COMSOL_Multiphysics/Equation_Based/kdv_equation

Line Mass Source

The **Line Mass Source** feature models mass flow originating from a tube or line region with an infinitely small radius.



This feature is only available in a limited set of add-on products. See <https://www.comsol.com/products/specifications/> for more details on availability.

SELECTION

The **Line Mass Source** feature is available for all dimensions, but the applicable selection differs between the dimensions.

MODEL DIMENSION	APPLICABLE GEOMETRICAL ENTITY
2D	Points
2D Axisymmetry	Points not on the symmetry axis and the symmetry axis
3D	Edges

SPECIES SOURCE

Enter the source strength, $\dot{q}_{1,c}$, for each species (SI unit: mol/(m·s)). A positive value results in species injection from the line into the computational domain, and a negative value means that the species is removed from the computational domain.

Line sources located on a boundary affect the adjacent computational domains. This effect makes the physical strength of a line source located in a symmetry plane twice the given strength.

FURTHER READING

See the section [Mass Sources for Species Transport](#).

Point Mass Source

The **Point Mass Source** feature models mass flow originating from an infinitely small domain around a point.



This feature is only available in a limited set of add-on products. See <https://www.comsol.com/products/specifications/> for more details on availability.

SPECIES SOURCE

Enter the source strength, $\dot{q}_{p,c}$, for each species (SI unit: mol/s). A positive value results in species injection from the point into the computational domain, and a negative value means that the species is removed from the computational domain.

Point sources located on a boundary or on an edge affect the adjacent computational domains. This has the effect, for example, that the physical strength of a point source located in a symmetry plane is twice the given strength.

FURTHER READING

See the section [Mass Sources for Species Transport](#).

Open Boundary

Use this node to set up mass transport across boundaries where both convective inflow and outflow can occur. On the parts of the boundary where fluid flows into the domain, an exterior species concentration is prescribed. On the remaining parts, where fluid flows out of the domain, a condition equivalent to the **Outflow** node is instead prescribed.

The direction of the flow across the boundary is typically calculated by a fluid flow interface and is provided as a model input to the Transport of Diluted Species interface.



This feature is only available in a limited set of add-on products. See <https://www.comsol.com/products/specifications/> for more details on availability.

EXTERIOR CONCENTRATION

Enter a value or expression for the **Exterior concentration**.

Thin Diffusion Barrier

Use this boundary condition to model a thin layer through which mass is transported by diffusion only. The node is applicable on interior boundaries and can be used to avoid meshing thin structures.

THIN DIFFUSION BARRIER

Specify the **Layer thickness**, d_s , and input a **Diffusion coefficient**, $D_{s,c}$, for each of the species included.

Thin Impermeable Barrier

This feature models a thin mass transfer barrier. It is available on interior boundaries and introduces a discontinuity in the concentration across the boundary. On each side, a no-flux condition is prescribed for the mass transport implying that it acts as a barrier. The feature can be used to avoid meshing thin structures.

Solving a model involving coupled fluid flow and mass transfer, the Thin Impermeable Barrier feature can be combined with an Interior Wall feature in order to model a thin solid wall.

Equilibrium Reaction

Use this node to model a reaction where the kinetics is so fast that the equilibrium condition is fulfilled at all times. The node solves for an additional degree of freedom (the reaction rate R_{eq}) to fulfill the equilibrium condition at all times in all space coordinates.

If the **Apply equilibrium condition on inflow boundaries** check box is selected, the specified inflow concentration values in all active **Inflow** boundary nodes for the physics interface are modified to comply with the equilibrium condition.



- A necessary requirement for this feature to be available is that two or more species are solved for by the interface.
- This feature is only available in a limited set of add-on products. See <https://www.comsol.com/products/specifications/> for more details on availability.

EQUILIBRIUM CONDITION

The list defaults to **Equilibrium constant** or select **User defined**. For either option, the **Apply equilibrium condition on inflow boundaries** check box is selected by default.

For **Equilibrium constant**, enter an **Equilibrium constant** K_{eq} (dimensionless). Also enter a value or expression for the **Unit activity concentration** C_{a0} (SI unit: mol/m³).

Selecting **Equilibrium constant** defines an equilibrium condition based on the stoichiometric coefficients, the species activities, and the law of mass action.

For **User defined**, enter an **Equilibrium expression** E_{eq} (dimensionless).

STOICHIOMETRIC COEFFICIENTS

Enter a value for the stoichiometric coefficient ν_c (dimensionless). The default is 0. Use negative values for reactants and positive values for products in the modeled reaction.

Species with a stoichiometric coefficient value of 0 are not affected by the **Equilibrium Reaction** node.

FURTHER READING

See

- [Equilibrium Reaction Theory](#)
- [Theory for the Coupling of Mass Transport to Electrochemical Reactions](#)

Surface Reactions

The **Surface Reactions** node can be used to account for the species boundary flux due to chemical reactions occurring on a surface (heterogeneous reactions). For a domain species participating in a surface reaction, the boundary flux corresponds to the reaction rate at the surface.

SURFACE REACTION RATE

Specify the surface reaction rate J_0 of each species resulting from the reactions. Note that if you have the Chemistry interface available, provided with the Chemical Reaction Engineering Module, the reaction rate expressions can be automatically generated and picked up using the drop-down list.

When defining conditions on boundaries between different phases, see the section [Prescribing Conditions on Fluid-Solid Interfaces](#).

FURTHER READING

For an example of using the Surface Reactions node, see this application example:



Chemical Vapor Deposition of GaAs: Application Library path
**Chemical_Reaction_Engineering_Module/
Reactors_with_Mass_and_Heat_Transfer/gaas_cvd**

Surface Equilibrium Reaction

Use this node to model an equilibrium reaction on a boundary (surface). The settings for this node are similar to [Equilibrium Reaction](#). Note that a necessary requirement for this is feature to be available is that two or more species are solved for by the interface.

When defining conditions on boundaries between different phases, see the section [Prescribing Conditions on Fluid-Solid Interfaces](#).



This feature is only available in a limited set of add-on products. See <https://www.comsol.com/products/specifications/> for more details on availability.

Fast Irreversible Surface Reaction

This boundary node defines an irreversible reaction where the kinetics is so fast that the only factor limiting the reaction rate is the transport of a species to the reacting surface.

The node will set the **Rate limiting species concentration to zero** at the boundary, and balance the fluxes of the species participating in the reaction and the current densities according to the Stoichiometric Coefficients settings.

When defining conditions on boundaries between different phases, see the section [Prescribing Conditions on Fluid-Solid Interfaces](#).



This feature is only available in a limited set of add-on products. See <https://www.comsol.com/products/specifications/> for more details on availability.

Porous Electrode Coupling

Use this node to add a molar source in a domain that is coupled to one or multiple [Porous Electrode Reaction](#) nodes of an Electrochemistry Interface.

The molar source is calculated from the number of electrons, stoichiometric coefficients, and volumetric current densities of the coupled porous electrode reactions specified in the **Reaction Coefficients** subnodes.

In the Transport of Concentrated Species interface, the molar sources (or sinks) are multiplied by the species molar masses to obtain the corresponding mass sources.

Additional **Reaction Coefficients** subnodes are available from the context menu (right-click the parent node) as well as from the **Physics** toolbar, **Attributes** menu.

Note that if you are also modeling the momentum transport and expect a nonnegligible total mass source or sink, which is often the case in gas diffusion electrodes, you need to also add a corresponding Porous Electrode Coupling node in the Fluid Flow interface.



This feature is only available in a limited set of add-on products. See <https://www.comsol.com/products/specifications/> for more details on availability.

Reaction Coefficients

Add this node to the **Electrode Surface Coupling** and **Porous Electrode Coupling** features to define molar fluxes and sources based on electrode current densities in an **Electrochemistry** interface.

The molar flux or source is proportional to the stoichiometric coefficients and the current density according to Faraday's law.

Current densities from **Electrode Reaction** (i_{loc} , SI unit: A/m²) or **Porous Electrode Reaction** nodes (i_v , SI unit: A/m³) of any **Electrochemistry** interface in the model are available for selection as the **Coupled reaction**, and user-defined expressions are also supported.

Enter the **Number of participating electrons** n_m (dimensionless) and the **Stoichiometric coefficient** ν_c (dimensionless) as explained in the theory section linked below.

Use multiple subnodes to couple to multiple reactions.



[Theory for the Coupling of Mass Transport to Electrochemical Reactions](#)

Electrode Surface Coupling

Use this node to define a flux boundary condition based on current densities of one or multiple **Electrode Reaction** nodes in an Electrochemistry interface.

The flux is proportional to the current densities and the stoichiometric coefficients according to Faraday's law as defined by summation over the **Reaction Coefficients** subnodes.

Note that if you are also modeling the momentum transport and expect a nonnegligible total mass flux over the boundary, which is often the case for gas diffusion electrodes, you need to also add a corresponding Electrode Surface Coupling node in the Fluid Flow interface.



This feature is only available in a limited set of add-on products. See <https://www.comsol.com/products/specifications/> for more details on availability.

Porous Medium

Use this node to model the concentration of diluted species transported by a solvent (mobile fluid phase) through interstices in a solid porous medium. In addition to transport due to convection and diffusion, the node contains functionality to include species evolution through adsorption and dispersion.



This feature is only available in a limited set of add-on products. See <https://www.comsol.com/products/specifications/> for more details on availability.

Species transport through a porous medium is affected both by properties of the fluid phase, and as well as properties of the solid matrix. These properties are defined in the **Fluid** and **Porous Matrix** subnodes respectively. The Porous Medium node supports material properties using a **Porous Material** node (described in the *COMSOL Multiphysics Reference Manual*), where properties are defined per phase in a similar manner.

Add an **Adsorption** or a **Dispersion** subfeature to the **Porous Medium** to account for the corresponding transport mechanism.

Use this node to specify the mass transfer in the mobile fluid solvent filling the pores of a porous medium. It is used as a subnode to [Porous Medium](#).

MODEL INPUTS

The temperature model input is always available. By default, the **Temperature** model input is set to **Common model input**, and the temperature is controlled from [Default Model Inputs](#) under **Global Definitions** or by a locally defined [Model Input](#). If a Heat Transfer interface is included in the component, it controls the temperature **Common model input**. Alternatively, the temperature field can be selected from another physics interface. All physics interfaces have their own tags (**Name**). For example, if a Heat Transfer in Fluids interface is included in the component, the **Temperature (ht)** option is available for T .

You can also select **User defined** from the **Temperature** model input in order to manually prescribe T .

CONVECTION

If transport by convection is active, the velocity field of the solvent needs to be specified. For **User defined**, enter values or expressions for the velocity components in the input fields. This input option is always available. You can also select the velocity field solved for by a Fluid Flow interface added to the model component. These physics interfaces are available for selection in the **Velocity field** list.

DIFFUSION

Use this section to specify diffusion coefficients describing the diffusion of each species in the solvent fluid.

Use the **Source** list to select to pick up diffusion coefficients defined in a material or a Chemistry interface.

Select **Material**, and a **Fluid material** to use a diffusion coefficient in a material available in the model. User-defined property groups including a diffusion coefficient output property are available for selection in the **Fluid diffusion coefficient** list.

Select **Chemistry** to use a diffusion coefficient from a Chemistry interface added to model component. Diffusion coefficients are automatically defined when **Calculate transport properties** is selected on the interface level of a Chemistry interface. All defined diffusion coefficients are available for selection in the **Fluid diffusion coefficient** list.

For **User defined**, enter a value or expression for the **Fluid diffusion coefficient** $D_{F,i}$ of each species in the corresponding input field.

In a porous medium the diffusivity is reduced due to the fact that the solid grains impede Brownian motion. Select an **Effective diffusivity model** to account for the reduced diffusivity. The available models are **Millington and Quirk model** (the default), **Bruggeman model**, **Tortuosity model**, or **No correction**. For **Tortuosity model**, enter a value for the tortuosity $\tau_{F,i}$ (dimensionless).

Note that multiple species, as well as Migration in Electric fields (described below) is only available for certain COMSOL Multiphysics add-on products. See details: <https://www.comsol.com/products/specifications/>.

MIGRATION IN ELECTRIC FIELD

This section is available when the **Migration in electric field** check box is selected. From the **Electric potential** list, select the source of the electric field.

- For **User defined**, enter a value or expression for the **Electric potential** V . This input option is always available.
- Select the electric potential solved by an AC/DC-based interface that has added to the component.
- Select the electric potential defined or solved for by an Electrochemistry interface added to the component.

By default the **Mobility** is set to be calculated based on the species effective diffusivity and the temperature using the **Nernst-Einstein relation**. For **User defined**, select the appropriate scalar or tensor type — **Isotropic**, **Diagonal**, **Symmetric**, or **Full** — and type in the value or expression of the effective mobility $u_{me,i}$.

Enter the **Charge number** z_c for each species.

Porous Matrix

This node sets the porosity when modeling transport of diluted species in a **Porous Medium** or a **Unsaturated Porous Medium**.

The default **Porosity** ϵ_p of the solid matrix is taken **From material**. The Porous Matrix node supports the use of a **Porous Material** node, where the porosity is defined in the manner of

$$\varepsilon_p = 1 - \sum_i \theta_{s,i} - \sum_i \theta_{\text{imf},i}$$

where $\theta_{s,i}$ and $\theta_{\text{imf},i}$ are the porosities of the **Solid** and **Immobile Fluids** subnodes under the **Porous Material** node.

Select **From pellet bed densities** to compute the porosity using the (dry bulk) **Bed density** ρ_b and the (single phase) **Pellet density** ρ_{pe} . The porosity is then defined from

$$\varepsilon_p = 1 - \frac{\rho_b}{\rho_{pe}}$$

For **User defined**, enter a value or expression for the porosity.

Dispersion

Local variations in the velocity as the fluid flows around solid particles lead to mechanical mixing, referred to as dispersion. Use this feature to account for dispersion in a [Porous Medium](#) or a [Unsaturated Porous Medium](#)

This subfeature is available when both the **Mass transfer in porous media mass transfer** check box and the **Convection** check box are selected in the **Settings** window for the physics interface.

Select the **Specify dispersion for each species individually** check box to specify the dispersion tensor D_D (SI unit: m^2/s) for each species separately. When not selected the same dispersion tensor D_D is used for all species.

Select an option from the **Dispersion tensor** list — **Dispersivity** or **User defined**.

Select **Dispersivity** to specify the dispersion in terms of dispersivities (SI unit: m). Select an option from the **Dispersivity model** list: **Isotropic** (the default) or **Transverse isotropic** based on the properties of the porous media. For isotropic porous media, specify the longitudinal and transverse dispersivities. For transverse isotropic porous media, specify the longitudinal, horizontal transverse, and vertical transverse dispersivities.

For **User defined**, specify the dispersion components in terms of constants or expressions. Select **Isotropic**, **Diagonal**, **Symmetric**, or **Full** to enable the appropriate tensor components.

Unsaturated Porous Medium

Use this node to model the concentration of diluted species transported by a solvent (mobile fluid phase) through interstices in a solid porous medium. In addition to transport due to convection and diffusion, the node contains functionality to include species evolution through adsorption and dispersion.

Use this node to model the concentration of diluted species transported by a liquid (mobile fluid phase) in a partially filled solid porous medium. The interstices of the porous medium contains the liquid carrier phase and gas pockets. Apart from convection and diffusion, the node contains functionality to include species evolution through adsorption, dispersion, and volatilization.



This feature is only available in a limited set of add-on products. See <https://www.comsol.com/products/specifications/> for more details on availability.

The properties of each phase present are defined using the [Liquid](#), the [Gas](#), and the [Porous Matrix](#) subnodes respectively. The **Unsaturated Porous Medium** node supports material properties using a [Porous Material](#) node (described in the *COMSOL Multiphysics Reference Manual*), where properties are defined per phase in a similar manner.

Add an [Adsorption](#) or a [Dispersion](#) subfeature to the **Unsaturated Porous Medium** to account for the corresponding transport mechanism.

Liquid

Use this node to specify the mass transfer in the mobile liquid solvent present in the pores of the [Unsaturated Porous Medium](#).

MODEL INPUTS

The temperature model input is always available. By default, the **Temperature** model input is set to **Common model input**, and the temperature is controlled from [Default Model Inputs](#) under **Global Definitions** or by a locally defined [Model Input](#). If a Heat Transfer interface is included in the component, it controls the temperature **Common model input**. Alternatively, the temperature field can be selected from another physics interface. All physics interfaces have their own tags (**Name**). For example, if a Heat Transfer in Fluids interface is included in the component, the **Temperature (ht)** option is available for T .

You can also select **User defined** from the **Temperature** model input in order to manually prescribe T .

SATURATION

Select **Saturation** or **Liquid volume fraction** from the list.

For **Saturation**, enter a value for s (dimensionless) between 0 and 1. The liquid volume fraction is then computed from the saturation and porosity as $\theta_l = \varepsilon_p s$.

For **Liquid volume fraction**, enter a value for θ_l (dimensionless) between 0 and the value of the porosity.

Select a **Liquid fraction time change**: **Liquid fraction constant in time** (the default), **Time change in liquid fraction**, or **Time change in pressure head**.

- For **Time change in fluid fraction**, enter $d\theta/dt$ (SI unit: 1/s).
- For **Time change in pressure head**, enter dH_p/dt (SI unit: m/s) and a **Specific moisture capacity** C_m (SI unit: 1/m). If a Darcy's Law interface is included in the component, the time change in pressure head solved for can be selected.

CONVECTION

If transport by convection is active, the velocity field of the solvent needs to be specified. For **User defined**, enter values or expressions for the velocity components in the input fields. This input option is always available. You can also select the velocity field solved for by a Fluid Flow interface added to the model component. These physics interfaces are available for selection in the **Velocity field** list.

DIFFUSION

Use this section to specify diffusion coefficients describing the diffusion of each species in the solvent liquid.

Use the **Source** list to select to pick up diffusion coefficients defined in a material or a Chemistry interface.

Select **Material**, and a **Liquid material** to use a diffusion coefficient in a material available in the model. User-defined property groups including a diffusion coefficient output property are available for selection in the **Liquid diffusion coefficient** list.

Select **Chemistry** to use a diffusion coefficient from a Chemistry interface added to model component. Diffusion coefficients are automatically defined when **Calculate transport properties** is selected on the interface level of a Chemistry interface. All

defined diffusion coefficients are available for selection in the **Liquid diffusion coefficient** list.

For **User defined**, enter a value or expression for the **Liquid diffusion coefficient** $D_{L,i}$ of each species in the corresponding input field.

In a porous medium the diffusivity is reduced due to the fact that the solid grains impede Brownian motion. Select an **Effective diffusivity model, liquid** to account for the reduced diffusivity in the liquid. The available models are **Millington and Quirk model** (the default), **Bruggeman model**, **Tortuosity model**, or **No correction**. For **Tortuosity model**, enter a value for the tortuosity $\tau_{L,i}$ (dimensionless).

Note that multiple species, as well as Migration in Electric fields (described below) is only available for certain COMSOL Multiphysics add-on products. For details see: <https://www.comsol.com/products/specifications/>.

MIGRATION IN ELECTRIC FIELD

This section is available when the **Migration in electric field** check box is selected. From the **Electric potential** list, select the source of the electric field.

- For **User defined**, enter a value or expression for the **Electric potential** V . This input option is always available.
- Select the electric potential solved by an AC/DC-based interface that has added to the component.
- Select the electric potential defined or solved for by an Electrochemistry interface added to the component.

By default the **Mobility** is set to be calculated based on the species effective diffusivity and the temperature using the **Nernst-Einstein relation**. For **User defined**, select the appropriate scalar or tensor type — **Isotropic**, **Diagonal**, **Symmetric**, or **Full** — and type in the value or expression of the effective mobility $u_{me,i}$.

Enter the **Charge number** z_c for each species.

Gas

Use this node to specify the mass transfer in the gas phase present in the pores of the **Unsaturated Porous Medium**.

DIFFUSION

The settings for the diffusion of each species in the gas phase are identical to those in the [Liquid](#) subnode.

VOLATILIZATION

Enter a value for the volatilization isotherm $k_{G,c}$ (dimensionless) for each species.

Adsorption

Use this node to model adsorption of the (fluid phase) solute species onto the surface of the porous matrix. It is available as a subnode to the [Porous Medium](#) and the [Unsaturated Porous Medium](#) nodes.



This feature is only available in a limited set of add-on products. See <https://www.comsol.com/products/specifications/> for more details on availability.

MATRIX PROPERTIES

The density of the porous media is needed when modeling adsorption to the surface of the porous matrix. Choose to input either the **Dry bulk density** ρ , or the **Solid phase density** ρ_s . The former is the density of the porous matrix including empty pores, while the latter corresponds to the density of the pure solid phase. The density can be defined from the domain material by selecting **From material**, or from a user defined expression. When a **Porous Material** is used on the selection, the density will be requested from a **Solid** subfeature. Several **Solid** features can be used to model a homogeneous mixture of several solid components.

ADSORPTION

Select an **Adsorption isotherm** — **Langmuir**, **Freundlich**, **Toth**, **BET**, or **User defined** to specify how to compute c_p , the amount of species sorbed to the solid phase (moles per unit dry weight of the solid):

- For **Langmuir**:

$$c_P = c_{Pmax} \frac{K_L c}{1 + K_L c}, \quad K_P = \frac{\partial c_P}{\partial c} = \frac{K_L c_{Pmax}}{(1 + K_L c)^2}$$

Enter a **Langmuir constant** $k_{L,c}$ (SI unit: m^3/mol) and an **Adsorption maximum** $c_{p,max,c}$ (SI unit: mol/kg).

- For **Freundlich**:

$$c_P = K_F \left(\frac{c}{c_{ref}} \right)^N, \quad K_P = \frac{\partial c_P}{\partial c} = N \frac{c_P}{c}$$

Enter a **Freundlich constant** $k_{F,c}$ (SI unit: mol/kg), a **Freundlich exponent** $N_{F,c}$ (dimensionless), and a **Reference concentration** $c_{ref,c}$ (SI unit: mol/ m^3).

- For **Toth**:

$$c_P = c_{Pmax} \frac{b_T c}{(1 + (b_T c)^{N_T})^{1/N_T}}$$

and

$$K_P = \frac{\partial c_P}{\partial c} = c_{Pmax} b_T (1 + (b_T c)^{N_T})^{-\left(1 + \frac{1}{N_T}\right)}$$

Enter a **Toth constant** $b_{T,c}$ (SI unit: m^3/mol), a **Toth exponent** $N_{T,c}$ (dimensionless), and an **Adsorption maximum** $c_{p,max,c}$ (SI unit: mol/kg).

- For **BET (Brunauer-Emmett-Teller)**:

$$c_P = \frac{K_B c_0 c}{(c_S - c) \left(1 + (K_B - 1) \frac{c}{c_S} \right)}$$

and

$$K_P = \frac{\partial c_P}{\partial c} = \frac{K_B c_0 c_S ((K_B - 1) c^2 + c_S^2)}{(c - c_S)^2 (c_S + (K_B - 1) c)^2}$$

Enter a **BET constant** $K_{B,c}$ (dimensionless), a **Monolayer adsorption capacity** $c_{0,c}$ (SI unit: mol/kg), and an **Saturation concentration** $c_{S,c}$ (SI unit: mol/ m^3).

- For **User defined** enter an **Adsorption isotherm** $c_{P,c}$ (SI unit: mol/kg):

$$c_p = f(c)$$

For more information, see [Adsorption](#) in the theory section.

FURTHER READING

See the theory chapter in the section [Mass Balance Equation for Transport of Diluted Species in Porous Media](#).

Volatilization

This feature is available when the **Mass transfer in porous media** check box is selected in the **Settings** window for the physics interface.

Use this feature to model mass transfer at the boundary due to volatilization. The species dissolved in the liquid are assumed to be vaporized at the boundary, and transported into the surrounding bulk region due to convection and diffusion. The mass transfer at the boundary is defined as

$$-\mathbf{n} \cdot \mathbf{J}_c = -h_c(k_{G,c}c - c_{\text{Gatm},c})$$

where h_c is the mass transfer coefficient, $k_{G,c}$ the volatilization coefficient, and $c_{\text{Gatm},c}$ the concentration in the surrounding atmosphere.



This feature is only available in a limited set of add-on products. See <https://www.comsol.com/products/specifications/> for more details on availability.

VOLATILIZATION

Enter a **Mass transfer coefficient** h_c defining the transfer into the surrounding media. This can be given by boundary layer theory. When assuming that no convective flow is present in the surrounding, the mass transfer coefficient can be defined from the gas diffusion coefficient D_{Gc} and the thickness of the diffusion layer d_s in the manner of

$$h_c = \frac{D_{Gc}}{d_s}$$

Also give the atmospheric concentration for each species, $c_{\text{Gatm},c}$. The **Volatilization** coefficient $k_{G,c}$ for each species are taken from the adjacent [Unsaturated Porous Medium](#) domain.

Species Source

In order to account for consumption or production of species in porous domains, the **Species Source** node adds source terms expressions S_i to the right-hand side of the species transport equations.

DOMAIN SELECTION

From the **Selection** list, choose the domains on which to define rate expression or expressions that govern the source term in the transport equations.

If there are several types of domains, with subsequent and different reactions occurring within them, it might be necessary to remove some domains from the selection. These are then defined in an additional **Species Source** node.

SPECIES SOURCE

Add a source term S_i (SI unit: mol/(m³·s)) for each of the species solved for. Enter a value or expression in the field of the corresponding species.

Hygroscopic Swelling

The **Hygroscopic Swelling** multiphysics coupling node () is used for moisture concentration coupling between the Solid Mechanics interface and either the Transport of Diluted Species or Transport of Diluted Species in Porous Media interfaces.

Hygroscopic swelling is an effect of internal strain caused by changes in moisture content. This volumetric strain can be written as

$$\varepsilon_{hs} = \beta_h M_m (c_{mo} - c_{mo,ref})$$

where β_h is the coefficient of hygroscopic swelling, M_m is the molar mass, c_{mo} is the moisture concentration, and $c_{mo,ref}$ is the strain-free reference concentration.

This feature requires a license of either the MEMS Module or the Structural Mechanics Module. The multiphysics feature will appear automatically if both the Transport of Diluted Species and the Solid Mechanics interfaces are added to the same component. For the most current information about licensing, please see See <https://www.comsol.com/products/specifications/>.

FURTHER READING

More information about how to use hygroscopic swelling can be found in [Hygroscopic Swelling Coupling](#) section in the *Structural Mechanics Module User's Guide*.

More information about multiphysics coupling nodes can be found in the section [The Multiphysics Branch](#) in the *COMSOL Multiphysics Reference Manual*.

Out-of-Plane Flux

The out-of-plane flux node is used to prescribe a flux in an out-of-plane domain, and it can be used to reduce a model geometry to 2D, or even 1D, when the concentration variation is small in one or more directions. This could be the case for example when the object to model is thin or slender. [Figure 6-1](#) shows examples of possible situations in which this type of geometry reduction can be applied.

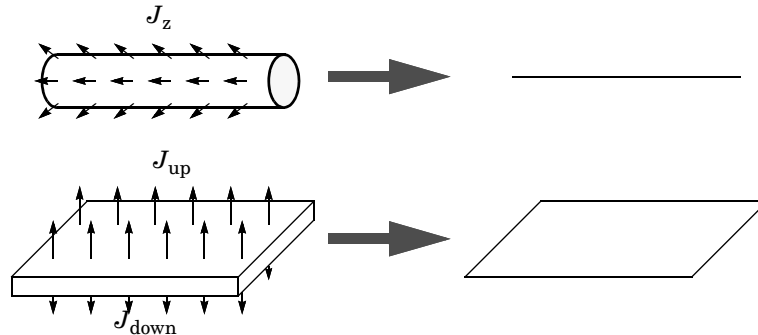

Figure 6-1: Geometry reduction from 3D to 1D (top) and from 3D to 2D (bottom).

For a 1D component this node adds a single out-of-plane molar flux $J_{0,z,i}$ for species i . For a 2D component two fluxes can be prescribed for each species; $J_{0,u,i}$ for the upside of the domain, and $J_{0,d,i}$ for the downside of the domain.

The fluxes are added as a source contribution to the right-hand side of the transport equation. For example, in 2D components with diffusion, convection, and out-of-plane flux present, the mass transfer of species i is defined by the mass conservation equation

$$\frac{\partial c_i}{\partial t} + \nabla \cdot \mathbf{J}_i + \mathbf{u} \cdot \nabla c_i = R_i + S_{\text{opf},i}, \quad (6-1)$$

where $S_{\text{opf},i}$ is the out-of-plane source for species i

$$S_{\text{opf},i} = \frac{J_{0,i}}{d_z} = \frac{J_{0,\text{u},i} + J_{0,\text{d},i}}{d_z}.$$

For external convection on the upside and the downside of the domain, the out-of-plane flux is

$$J_{0,i} = k_{c,\text{u},i}(c_{b,\text{u},i} - c_i) + k_{c,\text{d},i}(c_{b,\text{d},i} - c_i)$$

where k_c is a mass transfer coefficient and c_b is the bulk concentration, the typical concentration far into the surrounding exterior domain. The prescribed flux, J_0 , can include any arbitrary user-specified expressions. It can be a constant or a function of a dependent variable or independent variables.

UPSIDE INWARD FLUX

For 1D components, enter the **cross-sectional perimeter** P_c to get the out-of-plane flux

$$J_{0,i} = P_c J_{0,z,i}.$$

The default value of P_c is the circumference. Either keep the default value, for a circular cross-section shape, or edit the value to get a user-defined shape of the out-of-plane cross-section.

The available flux type options are **General inward flux** and **External convection**. Select the **Species** check box for the species for which to specify the flux, and enter a value or expression for the inward flux in the corresponding field. Use a minus sign when specifying a flux directed out of the system. To use another boundary condition for a specific species, click to clear the check box for that species.

Set **Flux type** to **External convection** to prescribe a flux to or from an exterior domain (not modeled) assumed to include convection. The exterior can for example include a forced convection to control the temperature or to increase the mass transport. In this case the prescribed mass flux corresponds to

$$J_0 = k_c(c_b - c)$$

where k_c is a mass transfer coefficient and c_b is the bulk concentration, the typical concentration far into the surrounding exterior domain.

DOWNSIDE INWARD FLUX

The available options are **General inward flux** and **External convection**. The settings are the same as for the [Upside Inward Flux](#) section.

FURTHER READING

For an example of using the Out-of-Plane Flux node, see this application example:



Mass Transfer from a Thin Domain: Application Library path
Chemical_Reaction_Engineering_Module/Tutorials/thin_domain

Fracture

Use this node to model mass transport along thin fractures in porous media. The node assumes that the transport in the tangential direction along the fracture is dominant as a result of lower flow resistance.

The Fracture feature has two default subfeatures — the **Fluid (Fracture)** subfeature where convection and diffusion are specified and the **Fracture Material** subfeature where the porosity ϵ_p is defined.



This feature is only available in a limited set of add-on products. See <https://www.comsol.com/products/specifications/> for more details on availability.

FRACTURE PROPERTIES

Specify a value for the **Fracture thickness** d_{fr} .

For the **Fracture** boundary condition, there are a number of **Attributes** available which can be accessed either via the **Physics** Ribbon toolbar (for Windows) or by right-clicking on the **Fracture** node. These attributes are identical to the .

Fluid (Fracture)

Use this node to specify the mass transfer in the mobile fluid solvent filling the pores of a fracture.

It uses the same input options as the **Fluid** subfeature under the **Porous Medium** feature. There are further details about the settings.

MODEL INPUTS

The temperature model input is always available. By default, the **Temperature** model input is set to **Common model input**, and the temperature is controlled from **Default Model Inputs** under **Global Definitions** or by a locally defined **Model Input**. If a Heat

Transfer interface is included in the component, it controls the temperature **Common model input**. Alternatively, the temperature field can be selected from another physics interface. All physics interfaces have their own tags (**Name**). For example, if a Heat Transfer in Fluids interface is included in the component, the **Temperature (ht)** option is available for T.

CONVECTION

If transport by convection is active, the velocity field of the solvent needs to be specified. Select an option from the **Velocity field** list to specify the convective velocity along the fracture. For a consistent model, use a Fracture feature in a Darcy's Law interface to compute the fluid flow velocity in the fracture.

For **User defined**, enter values or expressions for the velocity components in the table shown

DIFFUSION

Use this section to specify diffusion coefficients describing the diffusion of each species in the solvent fluid.



The **Diffusion** settings are similar to those for the diffusion coefficients in the [Fluid](#) node under [Porous Medium](#).



Fracture Material

Specify the **Porosity**, ε_p (dimensionless) of the porous matrix. This is by default taken **From material**. Select **From pellet bed densities** to compute the porosity from the (dry bulk) **Bed density** ρ_b and the (single phase) **Pellet density** ρ_{pe} through the relation

$$\varepsilon_p = 1 - \frac{\rho_b}{\rho_{pe}}$$

For **User defined**, enter a value or expression for the porosity.

The Transport of Diluted Species in Fractures Interface

The **Transport of Diluted Species in Fractures (dsf)** interface () , found under the **Chemical Species Transport** branch () , is used to model the transport of a solute species along thin porous fractures, taking into account diffusion, dispersion, convection, and chemical reactions. The fractures are defined by boundaries and the solute species is assumed to be present in a solvent.

The interface supports simulation of species transport along boundaries in 2D and 3D, and axisymmetric components in 2D. The dependent variable is the molar concentration, c . Modeling multiple species transport is possible, whereby the physics interface solves for the molar concentration, c_i , of each species i .



This interface is only available in a limited set of add-on products. For a detailed overview of which interfaces are available in each product, visit <https://www.comsol.com/products/specifications/>

SETTINGS

The **Label** is the default physics interface name.

The **Name** is used primarily as a scope prefix for variables defined by the physics interface. Refer to such physics interface variables in expressions using the pattern `<name>.<variable_name>`. In order to distinguish between variables belonging to different physics interfaces, the `name` string must be unique. Only letters, numbers, and underscores (`_`) are permitted in the **Name** field. The first character must be a letter.

The default **Name** (for the first physics interface in the model) is `dsf`.

BOUNDARY SELECTION

If the model geometry includes boundaries that should not be included in the mass transfer simulation, remove those from the selection list.

OUT-OF-PLANE THICKNESS

For 2D components, the **Thickness** field (default value: 1 m) defines a parameter for the thickness of the geometry perpendicular to the two-dimensional cross-section. Both constant and varying thicknesses are supported. The value of this parameter is used,

among other things, to automatically calculate molar flow rates from the total molar flux.

TRANSPORT MECHANISMS

Use the **Convection** check box, available under **Additional transport mechanisms**, to control whether to also include convective transport.

CONSISTENT STABILIZATION

To display this sections, click the **Show** button () and select **Stabilization**. Use this section to control the application of the available consistent stabilization methods; **Streamline diffusion** and **Crosswind diffusion**.

- When the **Crosswind diffusion** check box is selected, a weak term that reduces spurious oscillations is added to the transport equation. The resulting equation system is always nonlinear. There are two options for the **Crosswind diffusion type**:
 - **Do Carmo and Galeão** — the default option. This type of crosswind diffusion reduces undershoots and overshoots to a minimum but can in rare cases give equation systems that are difficult to fully converge.
 - **Codina**. This option is less diffusive compared to the Do Carmo and Galeão option but can result in more undershoots and overshoots. It is also less effective for anisotropic meshes. The Codina option activates a text field for the **Lower gradient limit** g_{lim} . Its default value is $0.1 [\text{mol}/\text{m}^3] / \text{tds} \cdot \text{helem}$, where $\text{tds} \cdot \text{helem}$ is the local element size.
- For both consistent stabilization methods select an **Equation residual**. **Approximate residual** is the default and means that derivatives of the diffusion tensor components are neglected. This setting is usually accurate enough and is computationally faster. If required, select **Full residual** instead.

INCONSISTENT STABILIZATION

To display this section, click the **Show** button () and select **Stabilization**. By default, the **Isotropic diffusion** check box is not selected, because this type of stabilization adds artificial diffusion and affects the accuracy of the original problem. However, this option can be used to get a good initial guess for under resolved problems.

DISCRETIZATION

To display all settings available in this section, click the **Show** button () and select **Advanced Physics Options**.

The **Value type when using splitting of complex variables** setting should in most pure mass transfer problems be set to **Real**, which is the default. It makes sure that the dependent variable does not get affected by small imaginary contributions, which can occur, for example, when combining a Time Dependent or Stationary study with a frequency-domain study. For more information, see [Splitting Complex-Valued Variables](#) in the *COMSOL Multiphysics Reference Manual*.

DEPENDENT VARIABLES

The dependent variable name is **Concentration c** by default. A dependent variable name must be unique with respect to all other dependent variables in the component.

Add or remove species variables in the model and also change the names of the dependent variables that represent the species concentrations.

Enter the **Number of species**. Use the **Add concentration** (**+**) and **Remove concentration** () buttons as needed.

FURTHER READING



- [Mass Transport in Fractures](#) in the theory section.
- [Numerical Stabilization](#) in the *COMSOL Multiphysics Reference Manual*.
- [Domain, Boundary, and Pair Nodes for the Transport of Diluted Species Interface](#)
- In the *COMSOL Multiphysics Reference Manual*, see [Table 2-4](#) for links to common sections and [Table 2-5](#) for common feature nodes. You can also search for information: press F1 to open the **Help** window or Ctrl+F1 to open the **Documentation** window.

Boundary, Edge, Point, and Pair Nodes for the Transport of Diluted Species in Fractures Interface

The [Transport of Diluted Species in Fractures Interface](#) has the following boundary, edge, point, and pair nodes, listed in alphabetical order, available from the **Physics**

ribbon toolbar (Windows users), **Physics** context menu (Mac or Linux users), or by right-clicking to access the context menu (all users).

- Concentration
- Flux
- Fracture
- Inflow
- Initial Values
- No Flux
- Outflow
- Reactions
- Species Source

Furthermore, there are the following attributes to the **Fracture** node

- Adsorption
- Dispersion

Adsorption

Use this node to model adsorption of the fluid phase species onto the porous media surface of the fracture.

MATRIX PROPERTIES

Use the **Porous material** list to define a material specifying the matrix properties on the current selection. By default the **Boundary material** is used as [The Transport of Diluted Species in Fractures Interface](#) is active on boundaries only. The **Density** ρ of the porous media is needed when modeling adsorption to the surface of the porous matrix. By default the option **From material** is selected.

ADSORPTION

Select an **Adsorption isotherm** — **Langmuir** (the default), **Freundlich**, **Toth**, **BET**, or **User defined** to specify how to compute c_P , the amount of species sorbed to the solid phase (moles per unit dry weight of the solid). Also activate the check box for the species c_i for which adsorption takes place.

- For **Langmuir**:

$$c_P = c_{P\max} \frac{K_L c}{1 + K_L c} \quad \frac{\partial c_P}{\partial c} = \frac{K_L c_{P\max}}{(1 + K_L c)^2}$$

Enter a **Langmuir constant** $k_{L,c}$ (SI unit: m^3/mol) and an **Adsorption maximum** $c_{p,\max,c}$ (SI unit: mol/kg):

- For **Freundlich**:

$$c_P = K_F \left(\frac{c}{c_{\text{ref}}} \right)^N \quad \frac{\partial c_P}{\partial c} = N \frac{c_P}{c} \quad \text{Freundlich}$$

Enter a **Freundlich constant** $k_{F,c}$ (SI unit: mol/kg), a **Freundlich exponent** $N_{F,c}$ (dimensionless), and a **Reference concentration** $c_{\text{ref},c}$ (SI unit: mol/m^3).

- For **Toth**:

$$c_P = c_{P\max} \frac{b_T c}{(1 + (b_T c)^{N_T})^{1/N_T}}$$

and

$$\frac{\partial c_P}{\partial c} = c_{P\max} b_T (1 + (b_T c)^{N_T})^{-\left(1 + \frac{1}{N_T}\right)}$$

Enter a **Toth constant** $b_{T,c}$ (SI unit: m^3/mol), a **Toth exponent** $N_{T,c}$ (dimensionless), and an **Adsorption maximum** $c_{p,\max,c}$ (SI unit: mol/kg).

- For **BET (Brunauer-Emmett-Teller)**:

$$c_P = \frac{K_B c_0 c}{(c_S - c) \left(1 + (K_B - 1) \frac{c}{c_S} \right)}$$

and

$$\frac{K_B c_0 c_S ((K_B - 1)c^2 + c_S^2)}{(c - c_S)^2 (c_S + (K_B - 1)c)^2}$$

Enter a **BET constant** $K_{B,c}$ (dimensionless), a **Monolayer adsorption capacity** $c_{0,c}$ (SI unit: mol/kg), and a **Saturation concentration** $c_{S,c}$ (SI unit: mol/m^3).

- For **User defined**:

$$c_p = f(c)$$

Enter an adsorption isotherm $c_{p,c}$ (SI unit: mol/kg).

For more information, see [Adsorption](#) in the theory section.

FURTHER READING

See the theory chapter in the section [Mass Balance Equation for Transport of Diluted Species in Porous Media](#).

Concentration

Use this node to specify the species concentration on a fracture boundary (applied in points in 2D and along edges in 3D). For example, a $c = c_0$ condition specifies the concentration of species c .

CONCENTRATION

Individually specify the concentration for each species. Select the check box for the **Species** to specify the concentration, and then enter a value or expression in the corresponding field. To use another boundary condition for a specific species, click to clear the check box for the concentration of that species.

CONSTRAINT SETTINGS

To display this section, click the **Show** button () and select **Advanced Physics Options**. You can find details about the different constraint settings in the section [Constraint Reaction Terms](#) in the *COMSOL Multiphysics Reference Manual*.

Dispersion

Local variations in the velocity as the fluid flows around solid particles lead to mechanical mixing, referred to as dispersion. Use this feature to account for dispersion in a Fracture.

This subfeature is available when the **Convection** check box is selected in the **Settings** window for the physics interface.

Select the **Specify dispersion for each species individually** check box to specify the dispersion tensor D_D (SI unit: m^2/s) for each species separately. When not selected the same dispersion tensor D_D is used for all species.

Select an option from the **Dispersion tensor** list — **Dispersivity** or **User defined**.

Select **Dispersivity** to specify the dispersion in terms of dispersivities (SI unit: m). Select an option from the **Dispersivity model** list: **Isotropic** (the default) or **Transverse isotropic** based on the properties of the porous media. For isotropic porous media, specify the longitudinal and transverse dispersivities. For transverse isotropic porous media, specify the longitudinal, horizontal transverse, and vertical transverse dispersivities.

For **User defined**, specify the dispersion components in terms of constants or expressions. Select **Isotropic**, **Diagonal**, **Symmetric**, or **Full** to enable the appropriate tensor components.

Flux

This node can be used to specify the species flux across a boundary of a porous fracture (applied in points in 2D and along edges in 3D). The flux of species c is defined as

$$\mathbf{n} \cdot d_{\text{fr}}(D_c \nabla c) = d_{\text{fr}} N_0$$

where N_0 is an arbitrary user-specified flux expression. For example, N_0 can represent a flux due to chemical reactions, or a phase change. A positive N_0 implies that the concentration inside the fracture increases.

INWARD FLUX

The available options are **General inward flux** and **External convection**. If the latter is chosen, define a **Mass transfer coefficient** and a **Bulk concentration**. Specify the flux of each species individually. To use another boundary condition for a specific species, make sure that the check box for the mass fraction of that species is unchecked.

Inflow

Use this node to specify all species concentrations at a fracture inlet. The condition is applied in points in 2D and along edges in 3D.

If you want to specify the concentration of a subset of the partaking species, this can be done by using the [Concentration](#) node instead.

CONCENTRATION

For the concentration of each species $c_{0,c}$ (SI unit: mol/m³), enter a value or expression.

BOUNDARY CONDITION TYPE

This section in the settings is only available for some products. Search for “Inflow” on the page: <https://www.comsol.com/products/specifications/> for more details on availability.

The option **Concentration constraint** constrains the concentration values on the boundary by the use of pointwise constraints. The other option, **Flux (Danckwerts)** can be more stable and fast to solve when high reaction rates are anticipated in the vicinity of the inlet. Oscillations on the solutions can also be avoided in such cases. The latter condition uses a flux boundary condition based on the velocity across the boundary and the concentration values. See further details in the theory section.

CONSTRAINT SETTINGS

To display this section, click the **Show** button () and select **Advanced Physics Options**. You can find details about the different constraint settings in the section [Constraint Reaction Terms](#) in the *COMSOL Multiphysics Reference Manual*.

FURTHER READING

See the theory chapter in the section [Danckwerts Inflow Boundary Condition](#).

No Flux

This node can be used to specify that the species flux across a boundary of a porous fracture is zero. The condition is applied in points in 2D and along edges in 3D.

Outflow

Set this condition at fracture outlets where species are transported out of the model domain by fluid motion. The condition is applied in points in 2D and along edges in 3D. It is assumed that convection is the dominating transport mechanism across outflow boundaries, and therefore that diffusive transport can be ignored, that is:

$$\mathbf{n} \cdot (-D_c \nabla c) = 0$$

Reactions

Use the **Reactions** node to account for the consumption or production of species through chemical reactions in the fracture. Define the rate expressions as required.

BOUNDARY SELECTION

From the **Selection** list, choose the boundaries on which to define rate expression or expressions that govern the source term in the transport equations.

Several reaction nodes can be used to account for different reactions in different parts of the fracture.

REACTION RATES

Add a rate expression R_i for species i . Enter a value or expression in the field. Note that if you have the Chemistry interface available, included with the Chemical Reaction Engineering Module, the reaction rate expressions can be automatically generated and picked up using the drop-down list.

REACTING VOLUME

When specifying reaction rates for a species in a fracture, the specified reaction rate may have the basis of the pore volume of the fracture, or the total volume.

- For **Total volume**, the reaction expressions in are specified per unit volume of the fracture. The reaction expressions will be multiplied by the fracture thickness d_{fr} .
- For **Pore volume**, the reaction expressions in $\text{mol}/(\text{m}^3 \cdot \text{s})$ are specified per unit volume of total pore space in the fracture. The reaction expressions will be multiplied by the fracture thickness d_{fr} and the fracture porosity, ϵ_p .

Species Source

In order to account for consumption or production of species in a fracture, the **Species Source** node adds source terms expressions S_i to the right-hand side of the species transport equations.

BOUNDARY SELECTION



From the **Selection** list, choose the boundaries on which to define expressions that govern the source term in the transport equations.

If there are several different parts of the fracture, with subsequent and different sources occurring within them, it might be necessary to remove some boundaries from the selection. The sources in these can then be defined using an additional **Species Source** node.

SPECIES SOURCE

Add a source term S_i for each of the species solved for. Enter a value or expression in the field of the corresponding species.

The Transport of Concentrated Species Interface

The **Transport of Concentrated Species (tcs)** interface () , found under the **Chemical Species Transport** branch () when adding a physics interface, is used to study gaseous and liquid mixtures where the species concentrations are of the same order of magnitude and none of the species can be identified as a solvent. In this case, properties of the mixture depend on the composition, and the molecular and ionic interactions between all species need to be considered. The physics interface includes models for multicomponent diffusion, where the diffusive driving force of each species depends on the mixture composition, temperature, and pressure.

The physics interface solves for the mass fractions of all participating species. Transport through convection, diffusion, and migration in an electric field can be included.

It supports simulations of transport by convection, migration, and diffusion in 1D, 2D, and 3D as well as for axisymmetric components in 1D and 2D. The physics interface defines the equations for the species mass fractions, including a diffusion model (Mixture-averaged, Maxwell–Stefan, or Fick’s law).

The available transport mechanisms and diffusion models differs between various COMSOL products (see <https://www.comsol.com/products/specifications/>).

Some examples of what can be studied with this physics interface include:

- The evolution of a chemical species transported by convection and diffusion.
- The migration in an electric field in the case of ionic species, in mixtures and solutions that cannot be deemed as being diluted.
- Concentrated solutions or gas mixtures, where the concentration of all participating species are of the same order of magnitude, and their molecular and ionic interaction with each other therefore must be considered. This implies that the diffusive transport of a single species is dependent on the mixture composition, and possibly on the temperature, the electric potential, the pressure, or any combination.

When this physics interface is added, the following default nodes are also added in the **Model Builder** — **Transport Properties**, **No Flux**, and **Initial Values**. Then, from the **Physics** toolbar, add other nodes that implement, for example, boundary conditions and reactions. You can also right-click **Transport of Concentrated Species** to select physics features from the context menu.

SETTINGS

The **Label** is the default physics interface name.

The **Name** is used primarily as a scope prefix for variables defined by the physics interface. Refer to such physics interface variables in expressions using the pattern <name>.<variable_name>. In order to distinguish between variables belonging to different physics interfaces, the name string must be unique. Only letters, numbers, and underscores (_) are permitted in the **Name** field. The first character must be a letter.

The default **Name** (for the first physics interface in the model) is **tcs**.

EQUATION

The basic equation for the conservation of mass of a species i is:

$$\frac{\partial}{\partial t}(\rho\omega_i) + \nabla \cdot (\rho\omega_i\mathbf{u}) = -\nabla \cdot \mathbf{j}_i + R_i \quad (6-2)$$

Using the continuity equation, the sum of all species equations, the equation can be recast in its nonconservative form:

$$\rho \frac{\partial}{\partial t}(\omega_i) + \rho(\mathbf{u} \cdot \nabla)\omega_i = -\nabla \cdot \mathbf{j}_i + R_i \quad (6-3)$$

This form of the equation is the one used in the Transport of Concentrated Species interface. The equation displayed in the interface changes depending on the active transport mechanisms, the selected diffusion model, and the type of reactions modeled.

OUT-OF-PLANE THICKNESS

For 2D components, the **Thickness** field (default value: 1 m) defines a parameter for the thickness of the geometry perpendicular to the two-dimensional cross-section. Both constant and varying thicknesses are supported. The value of this parameter is used, among other things, to automatically calculate mass flow rates from the total mass flux.

CROSS-SECTIONAL AREA

For 1D components, enter a **Cross-sectional area** A_c (SI unit: m^2) to define a parameter for the area of the geometry perpendicular to the 1D component. Both constant and varying areas are supported. The value of this parameter is used, among other things, to automatically calculate mass flow rates from the total mass flux. The default is 1 m^2 .

TRANSPORT MECHANISMS

The Transport of Concentrated Species interface always accounts for transport due to convection and diffusion.

The available diffusion models and the additional transport mechanisms differs between various COMSOL products (see <https://www.comsol.com/products/specifications/>).

Diffusion Model

- The **Maxwell–Stefan** option employs the most detailed diffusion model, but is also the most computationally expensive. The model is intended for diffusion dominated models, and requires that the multicomponent Maxwell–Stefan diffusivities of all component pairs are known.
- The **Mixture-averaged** option is less computationally expensive than the Maxwell–Stefan model. It is a simpler model that can be used when variations in the partial pressures and temperature can be assumed to not affect the multicomponent diffusion. The model includes stabilization but requires the multicomponent Maxwell–Stefan diffusivities of all component pairs.
- The **Fick’s law** model is a general model that should be used when the diffusion is assumed Fickian, or when no multicomponent diffusivities are available. Also, when molecular diffusion is not the dominating transport mechanism and a robust but low order model is wanted, the Fick’s law options should be used. The model includes stabilization.

Additional Transport Mechanisms

Under **Additional transport mechanisms**, click to select or clear any combination of check boxes as needed.

Migration in Electric Field

Select the **Migration in electric field** check box to activate migration of ionic species due to an electric field. The resulting migration term is part of the relative mass flux vector.

Mass Transport in Porous Media

The **Mass transport in porous media** check box activates functionality specific to species transport in porous media. When selected the following domain features are enabled:

- [Porous Medium](#)
- [Porous Electrode Coupling](#)

Maxwell–Stefan Diffusion Model

When using the **Maxwell–Stefan** diffusion model the relative mass flux vector is

$$\mathbf{j}_i = -\rho\omega_i \sum_{k=1}^Q D_{ik} \mathbf{d}_k - \frac{D_i^T}{T} \nabla T$$

where \tilde{D}_{ik} (SI unit: m²/s) are the multicomponent Fick diffusivities, \mathbf{d}_k (SI unit: 1/m) is the diffusional driving force, T (SI unit: K) is the temperature, and D_i^T (SI unit: kg/(m·s)) is the thermal diffusion coefficient.

The diffusional driving force is defined as

$$\mathbf{d}_k = \nabla x_k + \frac{1}{p} \left[(x_k - \omega_k) \nabla p - \rho \omega_k \mathbf{g}_k + \omega_k \sum_{l=1}^Q \rho \omega_l \mathbf{g}_l \right] \quad (6-4)$$

where \mathbf{g}_k is an external force (per unit mass) acting on species k . In the case of an ionic species, the external force due to the electric field, which is added by selecting the **Migration in electric field** check box, is

$$\mathbf{g}_k = -\frac{z_k F}{M_k} \nabla \phi \quad (6-5)$$

where z_k is the species charge number, F (SI unit: A·s/mol) is Faraday's constant and ϕ (SI unit: V) is the electric potential.

Mixture-Averaged Diffusion Model

When using the **Mixture-averaged** diffusion model, the diffusive flux is formulated in terms of a mixture-averaged diffusion coefficient representing the diffusion of each species into the resulting mixture. The diffusion coefficient is based on the multicomponent Maxwell–Stefan diffusivities D_{ik} . The **Mixture-averaged** diffusion model is computationally less expensive, and significantly more robust than the [Maxwell–Stefan Diffusion Model](#), but constitutes an approximation of the multicomponent flux. For information on the flux formulation in this case see [Multicomponent Diffusion: Mixture-Averaged Approximation](#).

Fick's Law Diffusion Model

When using the **Fick's law** diffusion model, the diffusive flux is formulated in terms of a Fickian diffusion coefficient. The **Fick's law** diffusion model is computationally less expensive and significantly more robust than the [Maxwell–Stefan Diffusion Model](#), but constitutes an approximation of the multicomponent flux. For information on the flux formulation in this case see [Multispecies Diffusion: Fick's Law Approximation](#).

SPECIES

Select the species that this physics interface solves for using the mass constraint in [Equation 6-40](#) (that is, its value comes from the fact that the sum of all mass fractions must equal 1). In the **From mass constraint** list, select the preferred species. To minimize the impact of any numerical and model introduced errors, use the species with the highest concentration. By default, the first species is used.

$$\omega_1 = 1 - \sum_{i=2}^Q \omega_i \quad (6-6)$$

CONSISTENT AND INCONSISTENT STABILIZATION

To display this section, click the **Show** button () and select **Stabilization**.

- Two consistent stabilization methods are available — **Streamline diffusion** and **Crosswind diffusion**. Both are active by default.

The **Residual** setting applies to both the consistent stabilization methods.

Approximate residual is the default setting and it means that derivatives of the diffusion tensor components are neglected. This setting is usually accurate enough and computationally faster. If required, select **Full residual** instead.

- There is one inconsistent stabilization method, **Isotropic diffusion**, which is available when using the [Mixture-Averaged Diffusion Model](#) or [Fick's Law Diffusion Model](#).

ADVANCED SETTINGS

To display this section, click the **Show** button () and select **Advanced Physics Options**. Normally these settings do not need to be changed.

Regularization

From the **Regularization** list, select **On** (the default) or **Off**. When turned **On**, regularized mass fractions are calculated such that

$$0 \leq w_{i, \text{reg}} \leq 1$$

Regularized mass fractions are used for the calculation of composition-dependent material properties, such as the density.

Diffusion

The **Diffusion** settings are available for the approximate diffusion models Mixture-averaged and Fick's law.

When the **Mixture diffusion correction** is enabled, a flux correction is added to ensure that the net diffusive flux is zero. This typically also mean that the solution becomes less sensitive to the species selected to be computed from the mass constraint in the [Species](#) section. More information on this correction is available in the theory section [Multicomponent Diffusion: Mixture-Averaged Approximation](#).

The **Diffusion flux type** list controls the whether the molecular flux is assumed proportional to the mole fraction or the mass fraction. See [Multicomponent Diffusion: Mixture-Averaged Approximation](#) or [Multispecies Diffusion: Fick’s Law Approximation](#) for information on the diffusive flux formulation.

Pseudo Time Stepping

The **Use pseudo time stepping for stationary equation form** option adds pseudo time derivatives to the equation when the **Stationary** equation form is used in order to speed up convergence. When selected, a CFL number expression should also be defined. For the default **Automatic** option, the local CFL number (from the Courant–Friedrichs–Lewy condition) is determined by a PID regulator. For more information, see [Pseudo Time Stepping for Mass Transport](#).

DISCRETIZATION

To display all settings available in this section, click the **Show** button () and select **Advanced Physics Options**.

For more information about these settings, see the *Discretization* section under [The Transport of Diluted Species Interface](#).



In the *COMSOL Multiphysics Reference Manual* see [Table 2-4](#) for links to common sections and [Table 2-5](#) to common feature nodes. You can also search for information: press F1 to open the **Help** window or Ctrl+F1 to open the **Documentation** window.



-
- [Domain, Boundary, and Pair Nodes for the Transport of Concentrated Species Interface](#)
 - [Theory for the Transport of Concentrated Species Interface](#)
-



- *Species Transport in the Gas Diffusion Layers of a PEM*: Application Library path **Fuel_Cell_and_Electrolyzer_Module/Fuel_Cells/pem_gdl_species_transport_2d**
Web link: <https://www.comsol.com/model/species-transport-in-the-gas-diffusion-layers-of-a-pem-260>

DEPENDENT VARIABLES



Add or remove species in the model and also change the names of the dependent variables that represent the species concentrations.

Specify the **Number of species**. There must be at least two species. To add a single species, click the **Add concentration** button (+) under the table. To remove a species, select it in the list and click the **Remove concentration** button (≡) under the table. Edit the names of the species directly in the table.



The species are dependent variables, and their names must be unique with respect to all other dependent variables in the component.

The Transport of Concentrated Species in Porous Media Interface

This interface (), found under the **Chemical Species Transport** branch (), is used to calculate the chemical composition in a fluid mixture transported through the interstices of a porous media. The interface is the same as the *Transport of Concentrated Species* interface but it has a **Porous Medium** node added by default. All other features for porous media transport is always available.

This interface is dedicated to analyzing mass transport in porous media where the chemical species may be subjected to convection, diffusion, and migration in an electric field. The interface also includes reaction rate expressions and source terms for modeling chemical reactions in porous media. It is also possible to include regions with free flow.

The main feature of the interface is the **Porous Medium** node which adds the governing equations for the mass fractions of all present species. It has two subnodes, **Fluid** and **Porous Matrix**, which in turn are used to define the physical properties corresponding to each phase, and to prescribe the transport properties. The latter are typically the flow field, and when applicable, the electric field. The **Porous Medium** node supports the use of a **Porous Material** (described in the *COMSOL Multiphysics Reference*

Manual) for defining phase-specific properties, and for sharing them among different physics interfaces.

When this physics interface is added, the following default nodes are also added to the **Model Builder — Porous Medium, No Flux** (the default boundary condition), and **Initial Values**. Then, from the **Physics** toolbar, add other nodes that implement, for example, boundary conditions, reaction rate expressions, and species sources. You can also right-click **Transport of Concentrated Species in Porous Media** to select physics features from the context menu.

SETTINGS

The rest of the settings are the same as [The Transport of Concentrated Species Interface](#).

Domain, Boundary, and Pair Nodes for the Transport of Concentrated Species Interface

[The Transport of Concentrated Species Interface](#) has these domain, boundary, and pair nodes, listed in alphabetical order, available from the **Physics** ribbon toolbar (Windows users), **Physics** context menu (Mac or Linux users), or right-click to access the context menu (all users).



In general, to add a node, go to the **Physics** toolbar, no matter what operating system you are using. Subnodes are available by clicking the parent node and selecting it from the **Attributes** menu.



In the *COMSOL Multiphysics Reference Manual* see [Table 2-4](#) for links to common sections and [Table 2-5](#) to common feature nodes. You can also search for information: press F1 to open the **Help** window or Ctrl+F1 to open the **Documentation** window.



For axisymmetric components, COMSOL Multiphysics takes the axial symmetry boundaries (at $r = 0$) into account and automatically adds an **Axial Symmetry** node to the component that is valid on the axial symmetry boundaries only.

These nodes are described in this section or as indicated:

- Electrode Surface Coupling
- Equilibrium Reaction
- Fluid
- Flux
- Flux Discontinuity
- Inflow
- Initial Values
- Mass Fraction
- No Flux
- Open Boundary
- Out-of-Plane Flux
- Outflow
- Porous Matrix
- Porous Medium
- Porous Electrode Coupling¹
- Reaction
- Reaction Coefficients¹
- Reaction Sources
- Species Properties
- Surface Equilibrium Reaction
- Symmetry
- Thin Impermeable Barrier¹
- Transport Properties

Some features require certain add-on modules. See details <https://www.comsol.com/products/specifications/>

¹ The node is described for the Transport of Diluted Species interface.

Prescribing Conditions on Fluid-Solid Interfaces

Defining conditions on interfaces between different phases, typically a wall in contact with a fluid, it is worthwhile to be careful with how variables in the conditions are evaluated. COMSOL Multiphysics supports that variables are defined differently on adjacent domains (or any other geometry dimension). Evaluating a variable with differing definitions, the mean value is returned on a boundary separating the different domains. The density, pressure, or temperature are examples of variables that may differ in a fluid and a solid. In order to specify on which side a variable is evaluated, the [up and down](#) operators (described in the *COMSOL Multiphysics Reference Manual*) can be used.

Species Properties

Use this node to define parameters specific to each of the species.

The node will change its label depending on what inputs are available in the node. If only **Molar Mass** is available, it will be labeled “Species Molar Masses”.

MOLAR MASS

Enter a value or expression for the **Molar mass** M_w for each species. The default value is 0.032 kg/mol, which is the molar mass of O₂ gas.

CHARGE

This section is available when the **Migration in electric field** check box is selected in the **Transport Mechanisms** section of the interface. Enter the charge number z_w (dimensionless, but requires a plus or minus sign) for each species.

Transport Properties

The **Transport Properties** is the main node used to model mass transfer in a fluid mixture with the Transport of Concentrates species interface. The node adds the equations governing the mass fractions of all present species, and provides inputs for the transport mechanisms and for the material properties of the fluid mixture.

The settings in this node are dependent on the check boxes selected under **Transport Mechanisms** in the Settings window of the Transport of Concentrated Species interface.

The options available in this feature differs between COMSOL products. (See <https://www.comsol.com/products/specifications/>).

MODEL INPUTS

Specify the temperature and pressure to be used in the physics interface. The temperature model input is used when calculating the density from the ideal gas law, but also when thermal diffusion is accounted for by supplying thermal diffusion coefficients. The pressure model input is used in the diffusional driving force in **Equation 6-4** (that is, when a **Maxwell–Stefan Diffusion Model** is used) and when calculating the density from the ideal gas law.

Temperature

Select the source of the **Temperature** field T :

- Select **User defined** to enter a value or an expression for the temperature (SI unit: K). This input is always available.
- If required, select a temperature defined by a Heat Transfer interface present in the model (if any). For example, select **Temperature (ht)** to use the temperature defined by the Heat Transfer in Fluids interface with the ht name.

Absolute Pressure

Select the source of the **Absolute pressure** p :

- Select **User defined** to enter a value or an expression for the absolute pressure (SI unit: Pa). This input is always available.
- In addition, select a pressure defined by a Fluid Flow interface present in the model (if any). For example, select **Absolute pressure (spf)** to use the pressure defined in a Laminar Flow interface with spf as the name.

DENSITY

Define the density of the mixture and the molar masses of the participating species.

Mixture Density

Select a way to define the density from the **Mixture density** list — **Ideal gas** or **User defined**:

- For **Ideal gas**, the density is computed from the ideal gas law in the manner of:

$$\rho = \frac{pM}{R_g T}$$

Here M is the mean molar mass of the mixture and R_g is the universal gas constant. The absolute pressure, p , and temperature, T , used corresponds to the ones defined in the [Model Inputs](#) section.

- For **User defined** enter a value or expression for the **Mixture density** ρ .

CONVECTION

Select the source of the **Velocity field** \mathbf{u} :

- Select **User defined** to enter manually defined values or expressions for the velocity components. This input is always available.
- Select a velocity field defined by a Fluid Flow interface present in the model (if any). For example, select **Velocity field (spf)** to use the velocity field defined by the **Fluid**

Properties node fp1 in a Single-Phase Flow, Laminar Flow interface with **spf** as the Name.

DIFFUSION

Specify the molecular and thermal diffusivities of the present species based on the selected **Diffusion model**.

When using a [Maxwell–Stefan Diffusion Model](#) or a [Mixture-Averaged Diffusion Model](#), select the **Binary diffusion input type** (Table or Matrix) and specify the **Maxwell–Stefan diffusivities** in the table or matrix, then enter the **Thermal diffusion coefficients** D_w^T .

When using a [Fick’s Law Diffusion Model](#), specify the **Diffusion coefficient** D_w^F and the **Thermal diffusion coefficients** D_w^T for each of the species.

Maxwell–Stefan Diffusivity Matrix

Using a [Maxwell–Stefan Diffusion Model](#) or a [Mixture-Averaged Diffusion Model](#), the **Maxwell–Stefan diffusivity matrix** D_{ik} (SI unit: m^2/s) can be specified by a table or matrix. For a simulation involving Q species the Maxwell–Stefan diffusivity matrix is a Q -by- Q symmetric matrix, where the diagonal components are 1. Enter values for the upper triangular components, D_{ij} , which describe the interdiffusion between species i and j . For the table input type, only upper triangular components (D_{ij}) are listed. The name of species pair consists of species in the first and second column. For the matrix input type, the numbering of the species corresponds to the order, from top to bottom, used for all the input fields for species properties (see for example the molar mass fields in the [Density](#) section). The Maxwell–Stefan diffusivity matrix is used to compute the multicomponent Fick diffusivities as described in [Multicomponent Diffusivities](#).

Diffusion Coefficient

Using a [Fick’s Law Diffusion Model](#), the diffusion is by default assumed to be isotropic and governed by one **Diffusion coefficient** D_w^F (SI unit: m^2/s) for each species. To allow for a general representation, it is also possible to use diffusion matrices (diagonal, symmetric, or anisotropic).

Thermal Diffusion Coefficient

To model thermal diffusion, prescribe the **Thermal diffusion coefficients** D_i^T (SI unit: $\text{kg}/(\text{m}\cdot\text{s})$), by entering one thermal diffusion coefficient for each species in the corresponding field. In a multicomponent mixture, the sum of the thermal diffusion coefficients is zero. The default value for all thermal diffusion coefficients is 0.

Specify the molecular and thermal diffusivities of the present species based on the selected **Diffusion model**.

MIGRATION IN ELECTRIC FIELD

This section is available when the **Migration in electric field** check box is selected for the Transport of Concentrated Species interface.

Electric Potential

- Select **User defined** to enter a value or expression for the electric potential. This input is always available.
- If required, select an electric potential defined by an AC/DC interface that is present in the model (if any). For example, select **Electric potential (ec)** to use the electric field defined by the Current Conservation node `cucn1` in an Electric Currents interface `ec`.

Settings for the mobilities are used for the **Mixture-averaged** and **Fick's law** transport models. By default the mobility is set to be calculated based on the species diffusivities and the temperature using the **Nernst-Einstein relation**. To manually specify the mobilities, select **User defined** for the mobility $u_{m,c}$ (SI unit: s·mol/kg) and enter one value for each species.

The temperature (if you are using mobilities based on the Nernst–Einstein relation) is taken from the **Model Inputs** section.

Porous Medium

Use this node to model the composition in a gas or liquid mixture as it is transported through the interstices of solid porous medium. In addition to transport due to convection and diffusion, the node contains functionality to include species evolution through reactions in the fluid phase.

Species transport in a porous medium is affected both by properties of the fluid phase as well as properties of the solid matrix. These properties are defined in the **Fluid** node and the **Porous Matrix** node respectively. The Porous Medium node supports material properties using a **Porous Material** node (described in the *COMSOL Multiphysics Reference Manual*), where properties are defined per phase in a similar manner.

Fluid

Use this node to specify the mass transport in a fluid phase filling the pores of a porous medium. It is used as a subnode to **Porous Medium**.

MODEL INPUTS

Specify the temperature and pressure in the fluid. The temperature model input is used when calculating the density from the ideal gas law, but also when thermal diffusion is accounted for by supplying thermal diffusion coefficients. The pressure model input is used in the diffusional driving force in [Equation 6-4](#) (that is, when a [Maxwell–Stefan Diffusion Model](#) is used) and when calculating the density from the ideal gas law.

Temperature

Select the source of the **Temperature** field T :

- Select **User defined** to enter a value or an expression for the temperature.
- When present, select a temperature defined by a Heat Transfer interface in the model. For example, select **Temperature (ht)** to use the temperature defined by the Heat Transfer in Fluids interface with the ht name.

Absolute Pressure

Select the source of the **Absolute pressure** p :

- Select **User defined** to enter a value or an expression for the absolute pressure.
- When present, select a pressure defined by a Fluid Flow interface present in the model. For example, select **Absolute pressure (spf)** to use the pressure defined in a Laminar Flow interface with spf as the name.

DENSITY

Use this section to define the density of the fluid phase, and to specify the molar masses of the participating species.

Mixture Density

Select a way to define the density from the **Mixture density** list — **Ideal gas** or **User defined**:

- For **Ideal gas**, the density is computed from the ideal gas law in the manner of:

$$\rho = \frac{pM}{R_g T}$$

Here M is the mean molar mass of the mixture and R_g is the universal gas constant. The absolute pressure, p , and temperature, T , used corresponds to the ones defined in the **Model Inputs** section.

- For **User defined** enter a value or expression for the **Mixture density** ρ .

CONVECTION

Select the source of the **Velocity field \mathbf{u}** :

- Select **User defined** to enter values or expressions for the velocity components. This input is always available.
- Select a velocity field defined by a Fluid Flow interface that solves for the velocity of the fluid. For example, select **Velocity field (spf)** to use the velocity field defined by in a Single-Phase Flow, Laminar Flow interface with `spf` as the Name.

When the interface is used in a reacting flow multiphysics coupling, the velocity is automatically defined and the input is disabled.

DIFFUSION

Specify the species molecular and thermal diffusivities in fluid phase in the manner described for the [Transport Properties](#) node.

To account for the effect of porosity in the diffusivities, select an **Effective diffusivity model** — **Millington and Quirk model**, **Bruggeman model**, **Tortuosity model**, or **No correction**. Using one of the first four models, the effective transport factor, f_e , is defined from the porosity and the fluid tortuosity factor in the manner of:

$$f_e = \frac{\varepsilon_p}{\tau_F} \quad (6-7)$$

For **No correction**, the effective transport factor is set to one.

- For the **Millington and Quirk model**, the effective transport factor is $\tau_F = \varepsilon_p^{-1/3}$.
- For the **Bruggeman model**, the effective transport factor is $\tau_F = \varepsilon_p^{-1/2}$.
- For the **Tortuosity model**, specify the tortuosity factor τ_F . Select either **Isotropic** to define a scalar value, or **Diagonal** or **Symmetric** to define anisotropic tensor values.

The species diffusivities and mobilities are automatically adjusted for porous media transport using the effective transport factor.

MIGRATION IN ELECTRIC FIELD

This section is available when the **Migration in electric field** check box is selected in the [Transport Mechanisms](#) section of the interface. Select the source of the **Electric potential V** :

- Select **User defined** to enter a value or expression for the electric potential.
- When present, select an electric potential defined by an AC/DC interface that is present in the model. For example, select **Electric potential (ec)** to use the electric field defined an Electric Currents interface ec.

Settings for the mobilities are needed for the **Mixture-averaged** and **Fick's law** diffusion models. By default the mobility is set to be calculated based on the species diffusivities (adjusted by the **Effective diffusivity model** in the **Diffusion** section) using the **Nernst-Einstein relation**. To manually specify the mobilities, select **User defined** for the mobility $u_{m,w}$ and enter one value for each species.

The temperature (if you are using mobilities based on the Nernst–Einstein relation) is taken from the **Model Inputs** section.

PORE WALL INTERACTIONS

In porous media, it is possible to include **Pore Wall Interactions**. This accounts for species collisions with the surrounding media, that is, the pore walls.

For the **Fick's law** and **Mixture-averaged** diffusion models, the diffusion coefficient D_i^M is corrected with the **Wall diffusion** coefficient D_i^W in the following way

$$D_i^{MW} = \left(\frac{1}{D_i^M} + \frac{1}{D_i^W} \right)^{-1}$$

For the **Maxwell-Stefan** diffusion model, the following term is added to the species force balance

$$\dots + \frac{x_i}{D_{i,\text{eff}}^W} \left(\frac{\mathbf{j}_i}{\omega_i \rho} + \mathbf{u}_W \right) = \mathbf{d}_i$$

For weakly adsorbing gases, the **Knudsen** formula can be applied for computing the wall diffusivities, based on the **Pore diameter** d_{pore} (SI unit: m). For other cases, choose **User defined**.



For isobaric systems featuring concentration gradients in porous media, concentration gradients may give rise to nonzero fluid velocity as a result of the wall interactions. This effect can be modeled using the **Maxwell-Stefan** diffusion model in combination **Pore Wall Interactions**. For this case the wall velocity variable \mathbf{u}_W (tcs.uW) can be used to contribute to the fluid momentum balance (either as a **Contributing Velocity** in **Darcy's law**, or as a **Volume Force** in either the **Brinkman Equations** or **Free and Porous Media Flow, Brinkman** interfaces. The multiphysics **Reacting Flow** nodes incorporates this contribution from \mathbf{u}_W automatically.

Porous Matrix

This node defines the porosity, defined as the volume fraction occupied by a fluid phase, when modeling transport in a **Porous Medium**.

The default **Porosity** ε_p of the solid matrix is taken **From material**. The Porous Matrix node supports the use of a **Porous Material** node, where the porosity is defined in the manner of

$$\varepsilon_p = 1 - \sum_i \theta_{s,i} - \sum_i \theta_{\text{imf},i}$$

where $\theta_{s,i}$ and $\theta_{\text{imf},i}$ are the volume fractions given in **Solid** and **Immobile Fluids** subnodes under the **Porous Material** node.

For **User defined**, enter a value or expression for the porosity.

Electrode Surface Coupling

Use this node to define a flux boundary condition based on current densities of one or multiple **Electrode Reaction** nodes in an Electrochemistry interface.

The flux is proportional to the current densities and the stoichiometric coefficients according to Faraday's law as defined by summation over the **Reaction Coefficients**

subnodes. The molar fluxes are multiplied by the species molar masses to obtain the corresponding mass fluxes.



This feature is only available in a limited set of add-on products. See <https://www.comsol.com/products/specifications/> for more details on availability.

MASS TRANSFER TO OTHER PHASES

When using the Reacting Flow coupling feature to model coupled momentum and mass transport, boundary conditions that results in a nonnegligible mass flux can be consistently handled by accounting for [The Stefan Velocity](#).

Select **Account for Stefan velocity** to update the Stefan velocity in accordance with the mass flux from the electrode reactions. One example that may benefit from this is when modeling gas diffusion electrodes.

Reaction

Use the **Reaction** node to specify the reaction kinetics for a single homogeneous chemical reaction. The resulting mass source terms for the species involved in the reaction are automatically defined and added on the selected domains. For turbulent flow, the Reaction node includes the Eddy-dissipation turbulent-reactions model.

REACTION RATE

Select a **Reaction rate** — **Automatic** (the default), or **User defined**. Selecting **Automatic** the laminar flow reaction rate is computed using the mass action law

For **User defined**, input a custom expression or constants for the **Reaction rate** r .

Specify the reaction stoichiometry by entering values for the stoichiometric coefficients (dimensionless) of each species. Enter negative values for reactants and positive values for products.

RATE CONSTANTS

When the **Use Arrhenius expressions** check box is not selected, input custom expressions or constants for the **Forward rate constant** k^f and **Reverse rate constant** k^r .

When the **Use Arrhenius expressions** check box is selected, enter values for the following parameters of the forward and reverse reactions:

- **Forward frequency factor** A^f and **Reverse frequency factor** A^r (dimensionless)

- **Forward activation energy** E^f and **Reverse activation energy** E^r
- **Forward temperature exponent** n^f and **Reverse temperature exponent** n^r (dimensionless)

TURBULENT FLOW

Note this section is only available when then licensed to the CFD Module (see <https://www.comsol.com/products/specifications/>).

When the **Turbulent-reaction model** is set to **None**, laminar flow is assumed and the reaction source terms are defined from the reaction stoichiometry and reaction rates prescribed.

When the **Turbulent-reaction model** is set to **Eddy-dissipation**, turbulent flow will be accounted for in the reaction mass sources. In this case, enter values for the **Turbulent reaction model parameters** α_{ED} and β_{ED} (dimensionless).

The **Eddy-dissipation** model also requires an estimation of the turbulent mixing time of the fluid flow turbulence. When a Fluid Flow interface defining it is present in the model, it can be selected from the **Turbulence time scale** list. For example, select **Turbulence time scale (spf/fp1)** to use the time scale defined by the **Fluid Properties** node fp1 in a Turbulent Flow, k - ε interface with the **Name** set to spf.

REGULARIZATION

Select **Rate expression** in order to regularize the individual rate expressions that are added to each species. If the mass fraction for a reactant species ω_i becomes smaller than its **damping limit**, ω_i^{dl} , the rate expression added to species ω_i is reduced linearly. If $\omega_i \leq 0$ for a reactant species, the reaction rate contribution to that species is completely removed. Similarly, if the mass fraction for a product species ω_j becomes larger than $1 - \omega_j^{dl}$, the rate expression added to that species is damped linearly. If $\omega_j \geq 1$ for a product species, the reaction rate contribution to that species is completely removed.

The default value for the **damping limit**, ω_i^{dl} , is 10^{-6} , which is appropriate for most applications, but can require adjustment when working with for example catalytic trace species.

Regularization of the rate expressions adds considerable stability to the reaction expressions, but should optimally only be used as a mean to reach convergence. If the regularization is active in too large parts of the domain, the mass balance can become affected since the regularization acts on the contributions to each individual species, not the reaction as a whole.

Reaction Sources

Use the **Reaction Sources** node to define mass source terms from one or more chemical reactions. Both homogeneous reactions as well as heterogeneous reactions occurring in a porous media can be studied. The node also includes the possibility to pick up automatically defined source term definitions from a Chemistry interface.

REACTIONS

Add an expression for the reaction mass source, R_i , for each individual species present, except for the one computed from the mass constraint (see [Species](#)). Enter a value or expression in the field for the corresponding species.

Select the **Mass transport to other phases** check box if mass is leaving or entering the fluid as a result of the reactions, for instance due to condensation or vaporization in a porous matrix. In this case the mass source for the species calculated from the mass constraint can also be specified. The net mass transfer corresponds to the sum of the mass sources for all species.

REACTING VOLUME

When specifying reaction sources for a species in porous media, the specified mass source may have the basis of the total volume, or the pore volume. For nonporous domains, the **Reacting Volume** setting has no impact.

- For **Total volume**, the reaction mass source expressions are specified per unit volume of the model domain.
- For **Pore volume**, the reaction mass source expressions are specified per unit volume pore space. In this case the reaction mass sources will be multiplied by the domain porosity ε_p (ε_p equals unity for nonporous domains).

Initial Values

The **Initial Values** node adds initial values for the mass fractions that can serve as an initial condition for a transient simulation, or as an initial guess for a nonlinear solver. If required, add additional **Initial Values** nodes from the **Physics** toolbar.

INITIAL VALUES

The initial mass fractions can be specified using a number of quantities. Select the type of input from the **Mixture specification** list. Select:

- **Mass fractions** (the default) to enter mass fractions ($\omega_{0,\omega 1}$ for example)

- **Mole fractions** to enter mole fractions ($x_{0,\omega 1}$ for example)
- **Molar concentrations** (SI unit: mol/m³) to enter molar concentrations ($c_{0,\omega 1}$ for example)
- **Number densities** (SI unit: 1/m³) to enter number densities ($n_{0,\omega 1}$ for example)
- **Densities** (SI unit: kg/m³) to enter densities ($\rho_{0,\omega 1}$ for example)

Enter a value or expression in the field for each species except for the one computed from the mass constraint.

INITIAL MIXTURE DENSITY

When the selecting **Molar concentrations**, **Number densities**, or **Densities** are selected from the **Mixture specification** list, the should also be specified. Select **Ideal gas** or **User defined** from the **Initial mixture density** list.

- For **Ideal gas**, also specify the **Initial pressure** p_0 and the **Initial Temperature** T_0 . Note that dependent variables solved for are evaluated to zero for initial values. When solving for pressure or temperature together with the mass fractions, apply the initial values from the corresponding interfaces here as well.
- For **User defined**, input a custom for the **Initial mixture density** ρ_{m0} .

Mass Fraction

The **Mass Fraction** node adds boundary conditions for the species mass fractions. For example, the following condition specifies the mass fraction of species i : $\omega_i = \omega_{i,0}$.

Set the mass fractions of all species except the one computed from the mass constraint. This ensures that the sum of the mass fractions is equal to one (see [Species](#)). This node is available for exterior and interior boundaries.

When defining conditions on boundaries between different phases, see the section [Prescribing Conditions on Fluid-Solid Interfaces](#).

MASS FRACTION

Specify the mass fraction for each species individually. Select the check box for the species to specify the mass fraction, and enter a value or expression in the corresponding field. To use another boundary condition for a specific species, click to clear the check box for the mass fraction of that species.

MASS TRANSFER TO OTHER PHASES

When using the Reacting Flow coupling feature to model coupled momentum and mass transport, boundary conditions that results in a nonnegligible mass flux can be consistently handled by accounting for [The Stefan Velocity](#).

Select **Account for Stefan velocity** to update the Stefan velocity in accordance with the prescribed mass fractions. Examples of cases that may benefit from this are, for example, when modeling surface reactions or phase change on an exterior boundary.

CONSTRAINT SETTINGS

To display this section, click the **Show** button () and select **Advanced Physics Options**.

Flux

The **Flux** node is available on exterior boundaries and can be used to specify the mass flux. The boundary mass flux for each species is defined in the manner of

$$-\mathbf{n} \cdot \mathbf{j}_i = j_{0,i} \quad (6-8)$$

where \mathbf{n} denotes the outward pointing normal of the boundary. The prescribed flux $j_{0,i}$ can contain an arbitrary flux expression. It can, for example, be used to represent a *heterogeneous reaction* or a separation process occurring at the boundary. The flux can, for example, be a function of ω_j , the temperature, the pressure or even the electric potential.

When defining conditions on boundaries between different phases, see the section [Prescribing Conditions on Fluid-Solid Interfaces](#).

CONVECTION

By default, the flux due to diffusion and migration in an electric field is prescribed. This is the appropriate flux condition when the relative velocity at the boundary is zero. When the fluid velocity is not equal to that of the boundary, for example due to a fluid injection, it is often convenient to prescribe the total flux including convection. To do so select **Include** in the **Convection** section. In this case the prescribed flux is defined as:

$$-\mathbf{n} \cdot (\mathbf{j}_i + \rho \mathbf{u} \omega_i) = j_0$$

MASS TRANSFER TO OTHER PHASES

When using the Reacting Flow coupling feature to model coupled momentum and mass transport, boundary conditions that results in a nonnegligible mass flux can be consistently handled by accounting for [The Stefan Velocity](#).

Select **Account for Stefan velocity** to update the Stefan velocity in accordance with the prescribed flux. Examples of cases that benefit from this are for example when modeling surface reactions or phase change on an exterior boundary. The Stefan velocity represents the mixture velocity resulting from mass fluxes at the wall. This section is not available when **Include** is selected in the **Convection** section.

INWARD FLUX

Specify the **Inward flux** for each species individually. Select the check box for the species to prescribe a flux for and enter a value or expression in the corresponding field. To use another boundary condition for a specific species, click to clear the check box for the flux of that species. Use a positive value for an inward flux.

External convection

Set **Flux type** to **External convection** to prescribe a mass flux to or from an exterior domain (not modeled) assumed to include convection. The exterior can for example include a forced convection to control the temperature or to increase the mass transport. In this case the prescribed mass flux corresponds to

$$\dot{j}_{0,i} = k_{\omega,i}(\omega_{b,i} - \omega_i) \quad (6-9)$$

where $k_{\omega,i}$ is a mass transfer coefficient and $\omega_{b,i}$ is the bulk mass fraction, the typical mass fraction far into the surrounding exterior domain.

Inflow

The **Inflow** node adds a boundary condition for an inflow boundary, defining the composition of the mixture. The node is available for exterior boundaries. The mixture composition can be specified using the following quantities:

- Mass fractions: $\omega_i = \omega_{0,i}$
- The mole fraction: $x_i = x_{0,i}$
- The molar concentration: $c_i = c_{0,i}$
- The number density, which describes the number of particles per volume: $n_i = n_{0,i}$
- The density: $\rho_i = \rho_{0,i}$
- The mass flow rates.

The node requires input for all species. (The **Mass Fraction** node can be used to specify boundary mass fractions for a subset of the active species in the interface.)

INFLOW

Select a **Mixture specification**:

- **Mass fractions** (the default) to enter mass fractions ($\omega_{0,\omega 1}$, for example)
- **Mole fractions** to enter mole fractions ($x_{0,\omega 1}$ for example)
- **Molar concentrations** (SI unit: mol/m³) to enter molar concentrations ($c_{0,\omega 1}$, for example)
- **Number densities** (SI unit: 1/m³) to enter number densities ($n_{0,\omega 1}$, for example)
- **Densities** (SI unit: kg/m³) to enter densities ($\rho_{0,\omega 1}$, for example)
- **Mass flow rates** (SI unit: kg/s) to enter the total mass flow over the boundary ($J_{in,\omega 1}$, for example)

Enter a value or expression in the field for each species except for the one computed from the mass constraint.

CONSTRAINT SETTINGS

To display this section, click the **Show** button () and select **Advanced Physics Options**.

No Flux

The **No Flux** node is the default boundary condition available for exterior boundaries. It should be used on boundaries across which there is no mass flux, typically exterior solid walls where no surface reactions occur. The condition applied for each species corresponds to

$$-\mathbf{n} \cdot \mathbf{j}_i = 0$$

where \mathbf{n} denotes the outward pointing normal of the boundary.

Out-of-Plane Flux

The out-of-plane flux node is used to prescribe a flux in an out-of-plane domain, and it can be used to reduce a model geometry to 2D, or even 1D, when the variation of mass fraction is small in one or more directions. This could be the case for example

when the object to model is thin or slender. Figure 6-1 shows examples of possible situations in which this type of geometry reduction can be applied.

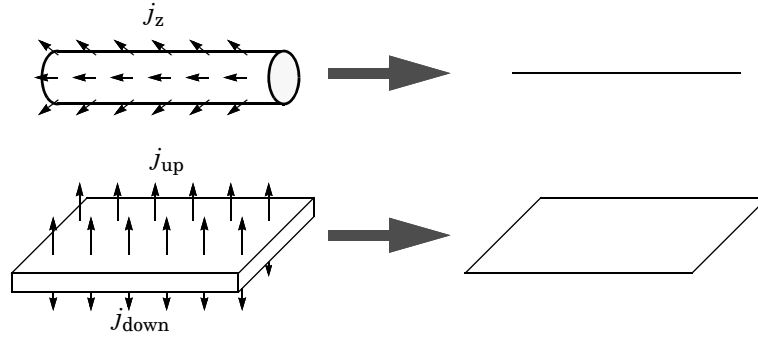

Figure 6-2: Geometry reduction from 3D to 1D (top) and from 3D to 2D (bottom).

For a 1D component this node adds a single out-of-plane mass flux $j_{0,z,i}$ for species i . For a 2D component two fluxes can be prescribed for each species; $j_{0,u,i}$ for the upside of the domain, and $j_{0,d,i}$ for the downside of the domain.

The fluxes are added as a source contribution to the right-hand side of the transport equation. For example, in 2D components with diffusion, convection, and out-of-plane flux present, the mass transfer of species i is defined by the mass conservation equation

$$\rho \frac{\partial}{\partial t}(\omega_i) + \rho(\mathbf{u} \cdot \nabla)\omega_i + \nabla \cdot \mathbf{j}_i = R_i + S_{\text{opf},i}, \quad (6-10)$$

where $S_{\text{opf},i}$ is the out-of-plane source for species i

$$S_{\text{opf},i} = \frac{j_{0,i}}{d_z} = \frac{j_{0,u,i} + j_{0,d,i}}{d_z}.$$

For external mass transfer on the upside and the downside of the domain, the out-of-plane flux is

$$j_{0,i} = k_{w,u,i}(w_{b,u,i} - w_i) + k_{w,d,i}(w_{b,d,i} - w_i)$$

where $k_{\omega,i}$ is a mass transfer coefficient and $\omega_{b,i}$ is the bulk mass fraction, the typical mass fraction far into the surrounding exterior domain. The prescribed flux, j_0 , can include any arbitrary user-specified expressions. It can be a constant or a function of a dependent variable or independent variables.

UPSIDE INWARD FLUX

For 1D components, enter the **cross-sectional perimeter** P_c to get the out-of-plane flux

$$j_{0,i} = P_c j_{0,z,i}$$

The default value of P_c is the circumference. Either keep the default value, for a circular cross-section shape, or edit the value to get a user-defined shape of the out-of-plane cross-section.

The available options are **General inward flux** and **External convection**. Specify the **Inward flux** for each species individually. Select the **Species** check box for the species for which to specify the flux, and enter a value or expression in the corresponding field. To use another boundary condition for a specific species, click to clear the check box for the flux of that species. Use a positive value for an inward flux.

Set **Flux type** to **External convection** to prescribe a mass flux to or from an exterior domain (not modeled) assumed to include convection. The exterior can for example include a forced convection to control the temperature or to increase the mass transport. In this case the prescribed mass flux corresponds to

$$j_{0,i} = k_{\omega,i}(\omega_{b,i} - \omega_i)$$

where $k_{\omega,i}$ is a mass transfer coefficient and $\omega_{b,i}$ is the bulk mass fraction, the typical mass fraction far into the surrounding exterior domain.

DOWNSIDE INWARD FLUX

The available options are **General inward flux** and **External convection**. The settings are the same as for the [Upside Inward Flux](#) section.

FURTHER READING

For an example of using the Out-of-Plane Flux node, see this application example:



Mass Transfer from a Thin Domain: Application Library path
Chemical_Reaction_Engineering_Module/Tutorials/thin_domain

Outflow

The **Outflow** node is the preferred boundary condition at outlets where the species are to be transported out of the model domain. It is useful, for example, in mass transport models where it is assumed that convection is the dominating effect driving the mass

flow through the outflow boundary. This node is available for exterior boundaries. The boundary condition is applied to all species and corresponds to one of the following equations depending on the selected diffusion model:

- For the [Mixture-Averaged Diffusion Model](#):

$$-\mathbf{n} \cdot \rho D_i^m \nabla \omega_i = 0$$

- For the [Fick's Law Diffusion Model](#):

$$-\mathbf{n} \cdot \rho D_i^f \nabla \omega_i = 0$$

Symmetry

The **Symmetry** node can be used to represent boundaries where the species concentration is symmetric; that is, there is no mass flux in the normal direction across the boundary:

$$-\mathbf{n} \cdot \mathbf{N} = -\mathbf{n} \cdot (\rho \omega_i \mathbf{u} + \mathbf{j}_i) = 0$$

This boundary condition is identical to the [No Flux](#) node, but applies to all species and cannot be applied to individual species. The Symmetry node is available for exterior boundaries.

Flux Discontinuity

The **Flux Discontinuity** node represents a discontinuity in the mass flux across an interior boundary:

$$-\mathbf{n} \cdot (\mathbf{N}_d - \mathbf{N}_u) = N_0 \quad \mathbf{N} = (\rho \omega_i \mathbf{u} + \mathbf{j}_i)$$

where the value of N_0 specifies the size of the flux jump evaluated from the down to the upside of the boundary.

FLUX DISCONTINUITY

Specify the jump in species mass flux. Use a positive value for increasing flux when going from the downside to the upside of the boundary. The boundary normal points in the direction from the downside to the upside of an interior boundary and can be plotted for visualization.

Select the **Species** check boxes to specify a flux discontinuity, and enter a value or expression for the **Flux discontinuity** N_0 (SI unit: $\text{kg}/(\text{m}^2 \cdot \text{s})$) in the corresponding field,

$N_{0,w1}$ for example. To use a different boundary condition for a specific species, click to clear the check box for the flux discontinuity of that species.

Open Boundary

Use the **Open Boundary** node to set up mass transport across boundaries where both convective inflow and outflow can occur. Use the node to specify an exterior species composition on parts of the boundary where fluid flows into the domain. A condition equivalent to the **Outflow** node applies to the parts of the boundary where fluid flows out of the domain. The direction of the flow across the boundary is typically calculated by a Fluid Flow interface and is entered as **Model Inputs**.

EXTERIOR COMPOSITION

Enter a value or expression for the species composition. Select:

- **Mass fractions** (the default) to enter mass fractions ($\omega_{0,\omega1}$, for example)
- **Mole fractions** to enter mole fractions ($x_{0,\omega1}$, for example)
- **Molar concentrations** (SI unit: mol/m³) to enter molar concentrations ($c_{0,\omega1}$, for example)
- **Number densities** (SI unit: 1/m³) to enter number densities ($n_{0,\omega1}$, for example) and to describe the number of particles per volume $n = n_0$
- **Densities** (SI unit: kg/m³) to enter densities ($\rho_{0,\omega1}$, for example)



A concentration quantity other than the mass fractions can only be used when all species are defined.

Equilibrium Reaction

Use this node to model a reaction where the kinetics is assumed so fast that the equilibrium condition is fulfilled at all times. The node solves for an additional degree of freedom (the reaction rate R_{eq}) to fulfill the equilibrium condition at all times in all space coordinates.



This feature is only available in a limited set of add-on products. See <https://www.comsol.com/products/specifications/> for more details on availability.

EQUILIBRIUM CONDITION

Selecting **Equilibrium constant** in the list, the following equilibrium condition based on the species activities and the law of mass action is used

$$K_{\text{eq}} = \frac{\prod_{i \in \text{products}} a_i^{v_i}}{\prod_{i \in \text{reactants}} a_i^{-v_i}}$$

where v_i are the stoichiometric coefficients and the species activities are defined from the concentration, c_i , and the unit activity concentration c_{a0} .

$$a_i = \frac{c_i}{c_{a0}}$$

Enter a value or expression for the dimensionless **Equilibrium constant** K_{eq} , and the **Unit activity concentration** C_{a0} .

Select **User defined** from the list to instead enter a manually defined **Equilibrium expression** E_{eq} .

STOICHIOMETRIC COEFFICIENTS

Enter a value for the stoichiometric coefficient ν for all participating species. Use negative values for reactants and positive values for products in the modeled reaction. Species with a stoichiometric coefficient value of 0 are not affected by the **Equilibrium Reaction** node.

Surface Equilibrium Reaction

Use this node to model an equilibrium reaction on a boundary (surface). The kinetics of the reaction is assumed so fast that the equilibrium condition is fulfilled at all times. The node solves for an additional degree of freedom (the mass flux J_{eq}) to fulfill the equilibrium condition at all times in all space coordinates along the boundary.





This feature is only available in a limited set of add-on products. See <https://www.comsol.com/products/specifications/> for more details on availability.

The settings for this node are the same as for **Equilibrium Reaction** except for the setting in the section below.

MASS TRANSFER TO OTHER PHASES

When using the Reacting Flow coupling feature to model coupled momentum and mass transport, boundary conditions that results in a nonnegligible mass flux can be consistently handled by accounting for [The Stefan Velocity](#). Select **Account for Stefan velocity** to update the Stefan velocity in accordance with the prescribed mass fractions. Examples of cases that may benefit from this are for example when modeling surface reactions or phase change on an exterior boundary.

The Chemistry Interface

The **Chemistry (chem)** interface () is found under the **Chemical Species Transport** branch () when adding a physics interface.

This physics interface is a tool for generating a set of variables to be used for modeling chemical species and reactions systems. The variables are generated from species and reaction properties and can be divided in two categories:

- Rate expressions and heat sources for use in mass and heat balances.
- Material property variables (mixture density, diffusivities, viscosity, and so on) for use in space-dependent transport equations.

Many of the fields and nodes described in this section are only made available when either a **Reaction** or a **Species** (or both) subnode is added to the Model Builder. All predefined constants and expressions can be overwritten by user-defined expressions. This makes it possible to go beyond the modeling assumptions set as defaults in this physics interface.

The following is a description of the features and fields available in the **Settings** window for the Chemistry interface.

SETTINGS

The **Label** is the default physics interface name.

The **Name** is used primarily as a scope prefix for variables defined by the physics interface. Refer to such physics interface variables in expressions using the pattern `<name>.<variable_name>`. In order to distinguish between variables belonging to different physics interfaces, the `name` string must be unique. Only letters, numbers, and underscores (`_`) are permitted in the **Name** field. The first character must be a letter.

The default **Name** (for the first physics interface in the model) is `chem`.

MODEL INPUT

This section sets the **Temperature**, **Pressure**, and **Electrode potential** (only available with a Battery Design Module, Corrosion Module, Electrochemistry Module, Electrodeposition Module, or Fuel Cell & Electrolyzer Module license) to be used by the current interface. Toggle the **Enable electrode reactions** check box to enable the Electrode Potential input in the **Model Input** section, as well as the **Electrode Reaction** and **Electrode Reaction Group** features. Use the lists to select a temperature, pressure,

or electrode potential defined and announced by another interface in the model. For example, when a heat transfer interface is also included, the temperature solved for is available in the **Temperature** list.

For **Temperature** or **Pressure**, you can also select **Common model input** to use a globally available common model input. In all three cases, select **User defined** to manually define the variable in question.

MIXTURE PROPERTIES

Type

Use this setting to define specify what kind of mixture assumption is used. For **Diluted Species** the mixture is composed of low concentration solutes present in a solvent. For **Concentrated Species** a mixture where no single species is considered to be in excess is assumed.

Select **Diluted species** from the **Type** list to use the concentration variables from a Transport of Diluted Species interface in the [Species Matching](#) section. The same setting should be used for any other interface solving for molar concentrations using a diluted species assumption. Select **Concentrated species** from the **Type** list to use the mass fractions from a Transport of Concentrated Species interface.

Thermodynamics

All property parameters and property functions required by the interface can be automatically created by coupling to a system added to the **Thermodynamics** node. To do so, click the **Thermodynamics** check box and select an existing [Thermodynamic System](#).

The **Thermodynamics** check box is enabled when the [Thermodynamics](#) node, including one or more systems, is available under **Global Definitions**. Also, the Chemistry interface needs to include at least one species.

Phase

Use the **Phase** list to specify the state of aggregation of the mixture.

SPECIES MATCHING

This section is used to match species solved for in space dependent physics interfaces to the species defined in Chemistry. By doing so the variables for the reaction kinetics and the mixture properties defined by Chemistry can be applied to study chemically reacting or composition dependent systems.

Species Solved For

Use this list to populate the inputs in the **Bulk species** table with dependent variables from a certain mass transfer interface. The **Species solved for** list contains all present interfaces of the **Type** selected in the **Mixture Properties** section. For example, when the **Type** is **Diluted species**, all Transport of Diluted Species interfaces or variants thereof, such as Transport of Diluted Species in Porous Media interface, are available in the list.

Bulk Species

Use the **Bulk species** table to specify the concentrations to be used as arguments in reaction kinetics variables, for example the reaction rate. Reaction kinetics variables are generated by the species features (**Species** and **Species Group**) and by the reaction features (**Reaction**, **Electrode Reaction**, **Reversible Reaction Group**, **Electrode Reaction Group**, and **Equilibrium Reaction Group**).

The bulk species concentrations are also used in the mixture properties, both for transport properties like the density and viscosity, and thermodynamic properties like the enthalpy or heat capacity.

When a mass transfer interface has been selected in the **Species solved for** list, use the **Molar concentration** column to select one of the dependent variables in the selected interface to the corresponding **Species** in Chemistry. When using a concentrated species interface (defined by the **Type** list in the **Mixture Properties** section), instead use the **Mass fraction** column to select a dependent variable for each species in Chemistry. For a consistent set up, the species molar mass in the Transport of Concentrated Species interface is updated to the one defined in the Chemistry interface.

The **Molar concentration** and **Mass fraction** columns also includes a **User defined** option, in which case a constant, parameter, or variable expression can be entered in the **Value** column.

Thermodynamics Coupling

When the **Thermodynamics** is enabled, the species in the Chemistry interface can be coupled to the species in the **Thermodynamic System**. This is needed to ensure that arguments for the thermodynamic functions are correctly defined. Use the drop-down lists in the **From Thermodynamics** column to match each species in the Chemistry to a species in the coupled thermodynamic system. For each thermodynamics-coupled species, the required property parameters and functions are added under the corresponding thermodynamic system. When all species are matched, the Chemistry is considered fully coupled and functions representing mixture properties, such as the density, are also added automatically under the same thermodynamic system.

Surface Species

The **Surface Species** table is available when there is at least one surface species (with “(ads)” as suffix).

Specify the concentration of surface species in the table in this section. In addition, if a surface species is present at the same time as an **Electrode Reaction**, the **Density of sites** input field becomes visible. The **Density of sites** input value will be used as the default reference concentration for surface species reacting in an **Electrode Reaction**.

The species present in this section will not be used to define mixture properties.

Solid Species

The **Solid Species** table is available when there is at least one solid species (with “(s)” as suffix).

Specify the concentration of solid species in the table in this section.

The species present in this section will not be used to define mixture properties.

Aqueous Species

The **Aqueous Species** table is available when there is at least one aqueous species (with “(aq)” as suffix).

Specify the concentration of solid species in the table in this section.

The species present in this section will not be used to define mixture properties.

Equilibrium Reaction Rate Table

This table is only available when equilibrium reactions are present in the interface. Use the **Reaction rate** column to specify the rate for each equilibrium reaction. By doing so the postprocessing variable for the total reaction rate for each species, of form `chem.Rsum_species`, will be updated correctly. For a mass transport interface, say Transport of Diluted Species, the reaction rate needed for an equilibrium reaction is typically a dependent variable. In that case, the name of the variable can be found in the **Shape Function** section of the **Equation View** of the node.

When the Chemistry interface is created using from the **Generate Space-Dependent Model** the table is automatically set up in accordance with the added equilibrium reaction nodes.

CALCULATE TRANSPORT PROPERTIES

Select the **Calculate mixture properties** check box (selected as default) to calculate mixture properties that can be picked up in the space-dependent model interfaces. The properties that can be calculated are shown beneath the check box. Consider also if the

built-in **Automatic** expressions fit the model or if **User defined** expressions are more suitable. In general, the Chemistry interface calculates properties in the same way as the Reaction Engineering interface.



Transport Properties

ACTIVITY

This section is available when the **Thermodynamics** check box is cleared.

Select the **Use activity** check box to solve for species activities instead of species concentrations, which is a common approach when nonideal fluids are modeled.

An activity coefficient other than 1 can be set for each species for the [Species](#) node in the **Species Concentration/Activity** section.

CHEMKIN IMPORT FOR SPECIES PROPERTIES

It is available when the **Thermodynamics** check box is cleared.

This section enables CHEMKIN[®] import to simulate complex chemical reactions in gas phase.

Two types of CHEMKIN input files can be imported here: **Thermo** and **Transport**, for thermodynamic properties and transport properties, respectively. Properties for either volumetric or surface species are supported. Click **Browse** to locate the CHEMKIN file to be imported, then click **Import**. For **Thermo**, the imported data is directly entered in the **NASA format** fields in the [Species](#) node's **Thermodynamic Expressions** section; for **Transport**, the imported data is entered in its **Transport Expressions** section.

Feature Nodes Available for the Chemistry Interface

The following feature nodes are available from the **Chemistry** ribbon toolbar (Windows users), **Chemistry** context menu (Mac or Linux users), or right-click to access the context menu (all users).

- Equilibrium Reaction Group
- Reaction
- Reaction Thermodynamics¹
- Electrode Reaction
- Electrode Reaction Group
- Reversible Reaction Group
- Species
- Species Activity
- Species Group
- Species Thermodynamics¹

¹ This is a subnode and it is only available together with a parent node.

Reaction

To add a **Reaction** node () either right-click the **Chemistry** node or in the **Chemistry** toolbar click **Reaction**.

REACTION FORMULA

Formula

Enter a chemical equation in the **Formula** field. The chemical equation should be of the format “A + B arrow C + D”. Here, A and B are reactants, C and D are product species, and arrow denotes a reaction arrow. The participating species should be written with [Valid Species Names](#). Valid reaction arrows are “<=>” for reversible reaction, “=>” for irreversible reaction, and “=” for equilibrium reaction. Species can be given trivial names, or their chemical formulas can be used as names. Examples of valid formulas are; “carbon+oxygen=>carbondioxide”, and “C(s)+O2(g)=>CO2(g)”.

Click **Apply** to make the interface examine the species taking part in the chemical equation, and automatically add the associated [Species](#) features to the Model Builder.

Balance ()

Use the **Balance** button to automatically calculate the stoichiometric coefficients such that the number of atoms of each kind are the same on both sides of the reaction. This turns, for example, the formula “H2+O2=>H2O” into “2H2+O2=>2H2O”. The balancing involves parsing all participating species for elements in the periodic table. It

therefore requires that all species in the **Formula** field are written either using their chemical formula, say “H2O”, or that each species in the reaction have an enabled **Chemical Formula** field in their **Species** node. For example, it is possible to balance the formula “H2+O2=>water” as long as there is a Species node with the name “water” already present, and an enabled **Chemical Formula**.

For automatic reaction balancing to be successful, requires that the problem is well posed. One example of a problem that is not well posed is “C+H2=>CH4+C2H6”, in which case any ratio of CH₄/C₂H₆ could be obtained. Another example is “H2=>O2” where not all elements are present on both sides.

Reaction Type

Select the **Reaction type** — **Reversible**, **Irreversible**, or **Equilibrium** — or edit the expression directly in the **Formula** field. In the latter case, specify the reaction type with a delimiter separating the two sides of the equation:

- <=> denotes a **Reversible** reaction
- => denotes an **Irreversible** reaction
- = denotes a reaction at chemical **Equilibrium**

Each **Reaction type** has its own set of reaction kinetics:

- If the reaction is **Reversible** or **Irreversible**, the reaction rate for reaction i contributes to the change in species i as follows:

$$R_i = \sum_j v_{ij} r_j \quad (6-11)$$

where v_{ij} is the stoichiometric coefficient.

- If it is an **Equilibrium** reaction, the equilibrium expression is equal to the equilibrium constant:

$$K_{\text{eq}} = K_{\text{eq}0}$$

REACTION RATE

This section is available when the **Reaction type** is either **Reversible** or **Irreversible**.

When **Mass action law** is selected (default), the rate expression is automatically derived from the stoichiometric coefficients in the reaction formula:

- For an **Irreversible** reaction type, the reaction rate becomes:

$$r_j = k_j^f \prod_{i \in \text{react}} c_i^{-\nu_{ij}} \quad (6-12)$$

- For a **Reversible** reaction type, the expression instead becomes:

$$r_j = k_j^f \prod_{i \in \text{react}} c_i^{-\nu_{ij}} - k_j^r \prod_{i \in \text{prod}} c_i^{\nu_{ij}} \quad (6-13)$$

The deduced overall reaction order is shown in text below the respective equation in the **Reaction Rate** section.

Arbitrary Rate Expression

If the reaction order differs from the stoichiometric coefficients, or if an arbitrary rate expressions is applicable, change **Reaction Rate** to **User defined**. An expression field r appears with the default expression being that from the mass action law. Below this there are fields to set the reaction order. For a reversible reaction the reverse reaction order may be specified in addition to the forward one. The unit of the rate constant k (or frequency factor A in the case of Arrhenius behavior), is derived from the reaction order, in SI units: $(\text{m}^3/\text{mol})^{\alpha-1}/\text{s}$, where α equals the order with respect to volumetric species. When surface species are present — identified by their “(ads)” suffix — the unit is instead given by $\text{m}^{3\alpha+2\beta-2}/\text{mol}^{\alpha+\beta-1}/\text{s}$, where β is the order with respect to surface species.

Consider for example the reaction:

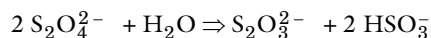

The automatically deduced reaction order is three, however, in the case that water is the solvent, the order should probably be two. This is specified as follows:

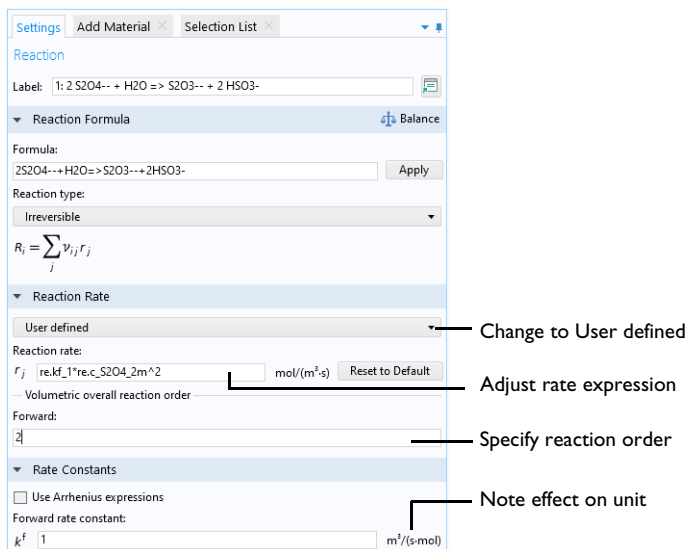

Figure 6-3: The reaction order can be manually specified for a user defined reaction rate.

RATE CONSTANTS

This section applies for **Reversible** or **Irreversible** reactions and defines the reaction rate constants used in the reaction rates.

Forward Rate Constant and Reverse Rate Constant

The **Forward rate constant** k^f is used for both **Reversible** and **Irreversible** reactions. The **Reverse rate constant** k^r is only used for **Reversible** reactions (Equation 6-12).

The SI units of the rate constants are automatically based on the order of the reaction with respect to the concentrations, as defined in the **Reaction formula**.

Specify Equilibrium Constant

The **Specify equilibrium constant** check box is available for **Reversible** reactions. If the check box is selected the rate constants are defined in a different manner with the reverse rate constant being computed from the following expression:

$$k^r = k^f / K_{eq0}$$

Thus, in this case, the forward rate constant and equilibrium constant for the reaction are needed. The **Equilibrium constant** is edited in the [Equilibrium Settings](#) section.

Use Arrhenius Expressions

When the **Use Arrhenius expressions** check box is selected the Arrhenius parameters are automatically used in predefined expressions for the forward and reverse rate constants k^f and k^r , respectively.

$$k^f = A^f (T/T_{\text{ref}})^{n^f} \exp(-E^f/(R_g T))$$

$$k^r = A^r (T/T_{\text{ref}})^{n^r} \exp(-E^r/(R_g T))$$

Specify the activation energy and the frequency factor in the Arrhenius expressions to account for temperature variations. The reference temperature, T_{ref} equals 1 K. The available fields are based on the **Reaction type** chosen in the [Reaction](#) node. Enter values or expressions for each of the following (reverse expressions are only available for reversible reactions):

- **Forward frequency factor** A^f and **Reverse frequency factor** A^r (unit depends on reaction order)
- **Forward temperature exponent** n^f and **Reverse temperature exponent** n^r
- **Forward activation energy** E^f and **Reverse activation energy** E^r (SI unit: J/mol)

EQUILIBRIUM SETTINGS

This section is available for equilibrium reactions, and for reversible reactions when the **Specify equilibrium constant** check box has been selected.

Equilibrium Expression

For an equilibrium reaction, specify the **Equilibrium expression**. When the **Equilibrium expression** is set to **Automatic** the following expression is used:

$$K_{\text{eqj}} = \frac{\prod_{i \in \text{prod}} c_i^{v_{ij}}}{\prod_{i \in \text{react}} c_i^{-v_{ij}}}$$

Select **User defined** from the **Equilibrium expression** list to instead enter a manually defined equilibrium expression.

Equilibrium Constant

Specify the **Equilibrium constant** K_{eq0} for an equilibrium reaction, or for a reversible reaction when the **Specify equilibrium constant** check box has been selected (in the **Rate Constants** section).

The **Equilibrium constant** can either be **User defined**, or automatically defined when set to **Automatic** or **Thermodynamics**.

Use the **Automatic** option to compute the equilibrium constant for an ideal system.

The **Thermodynamics** option is available when all reactions in the interface are equilibrium reactions, and the interface is fully coupled to a **Thermodynamic System** (see **Species Matching**). Use this setting to automatically compute the equilibrium constant for an ideal or nonideal system, dependent on the thermodynamic model applied for the coupled system.

Using **Automatic** or **Thermodynamics**, K_{eq0} is calculated from the Gibbs free energy of the reaction. For more details see **The Equilibrium Constant** and the **Automatically Defined Equilibrium Constants** section therein.

REACTION THERMODYNAMIC PROPERTIES

This section contains information about thermodynamic properties that relate to a selected reaction. Several **Automatic** definitions are available here.

Enthalpy of Reaction

The **Enthalpy of reaction** H (SI unit: J/mol) is calculated by the interface from species properties and the related stoichiometric coefficients:

$$H_j = \sum_{i \in \text{prod}} v_{ij} h_i - \sum_{i \in \text{react}} (-v_{ij}) h_i \quad (6-14)$$

Entropy of Reaction

The **Entropy of reaction** S (SI unit: J/(mol·K)) comes from a similar expression:

$$S_j = \sum_{i \in \text{prod}} v_{ij} s_i - \sum_{i \in \text{react}} (-v_{ij}) s_i \quad (6-15)$$

In **Equation 6-14** and **Equation 6-15**, h_i and s_i are the species' molar enthalpy and molar entropy, respectively.

Enter these quantities in the **Species Thermodynamic Expressions** section for the **Species** node either by using the predefined polynomial or by providing a custom expression or constants.

The stoichiometric coefficients, ν_{ij} , are defined as being negative for reactants and positive for products. Using [Equation 6-14](#) and [Equation 6-15](#) to equate the Gibbs free energy of reaction enables the equilibrium constant to be expressed according to [Equation 6-14](#).

Heat Source of Reaction

The **Heat source of reaction** (SI unit: W/m^3) is automatically computed from the heat of each reaction j , given by:

$$Q_j = -H_j r_j$$



Using the Reaction Node

Species

When a **Reaction** is defined, a **Species** node () is automatically generated for the participating reactants and products. This feature enables you to review and enter species specific information regarding chemical kinetics, thermodynamics, and transport properties.

It is also possible to add and define an individual **Species** node: in the **Chemistry** toolbar click **Species** or right-click the **Chemistry** node and select it from the context menu.

NAME

When a **Species** node is automatically generated using the **Formula** text field for the Reaction node, the **Name** is also automatically generated.

For a **Species** node added individually, enter a **Name** in the field and click **Apply**. By entering a name consisting of elements from the periodic table, the molar mass is calculated and added in the **Chemical Formula** section. The species charge, and type, are also deduced from the species name.



Valid Species Names

TYPE

Select a species type — **Bulk species**, **Surface species**, or **Solvent**. The latter is only available when a diluted solution is assumed. That is when **Type** is set to **Diluted Species** in the **Mixture Properties** section (in the interface level).

Bulk species and **Solvent** are solved for volumetric concentrations (SI unit: mol/m³), while **Surface species** are solved for surface concentration (SI unit: mol/m²). The compositions for **Bulk species** and **Solvent** use the syntax `c_speciesname`, while **Surface species** uses `csurf_speciesname_surf`.

When **Surface species** is selected, the corresponding reaction formula introduces **(ads)** after the species notation and changes the species' name to `speciesname_surf`. Additionally, the Species node name is updated in a similar fashion.

CHEMICAL FORMULA

The **Chemical Formula** section contains the species chemical formula, **Molar mass**, M , and **Charge**, z .

If the name entered for the species consists of only elements from the periodic table, and optionally charge and phase indication, then the **Chemical Formula** field will be populated with the name entered in the **Name** section, and the molar mass and charge will be added to this section. The species molar mass is computed from the mass of occurring individual elements¹. The rules for writing chemical formulas are the same as those for **Species** names.



Valid Species Names

When the species name contains parts not in the periodic table, for example when a descriptive name such as `water` is used, the molar mass is set to 0.0 kg/mol and the charge to zero. In this case, the molar mass needs to be defined in order to achieve mass balanced reactions and correct definitions of mass basis properties. By entering a chemical formula consisting only of elements from the periodic table (and optionally charge and phase indication), the molar mass, and charge are derived automatically.

When needed, the **Molar mass** can be edited in the corresponding text field. Editing the **Chemical formula** and pressing apply will override the molar mass and charge fields. The **Charge** field cannot be edited as long as a chemical formula is enabled.

1. Values are averages of upper and lower bounds for each atom as published by CIAAW. Source: CIAAW. Atomic weights of the elements 2019. Available online at www.ciaaw.org.

With an enabled **Chemical Formula** it is possible to use the trivial name of a species and balance reactions. Having added the Species water, oxygen, and hydrogen, and filled in H₂O, O, and H in their respective chemical formula sections, the **Formula** oxygen+hydrogen=water is balanced into oxygen+2hydrogen=water by clicking **Balance** in the **Reaction** node.

It is possible to specify the species density ρ when the fluid **Mixture** is specified as **Liquid**. The default value is that of water at 293 K.

REACTION RATE

Change the **Automatic** default setting to **User defined** to use a species reaction rate other than the one set up in the associated **Reaction** node. For individual species, use the **User defined** option to set a reaction rate other than zero (that is, nonreactive).

Edit either the **Rate expression** (SI unit: mol/(m³·s)), the **Surface rate expression** (SI unit: mol/(m²·s)), or both. For a bulk species, both expressions appear if surface reactions are present since the reaction of the species can depend both on bulk reaction R and surface reaction R_{ads} rates. For a surface species, only the surface reaction rate R_{ads} appears.

ADDITIONAL SOURCE

The **Additional Source** section is available in order to include additional rate contribution for the species to the reaction kinetics. When the **Additional source** check box is selected, add an **Additional rate expression** in the text field (SI unit: mol/m³).

CONSTANT CONCENTRATION/ACTIVITY

To account for nonideality in the fluid mixture, adjust the activity coefficient in the **Activity coefficient** input field. This input field is only shown if activity instead of concentration has been chosen in the interface, that is, the **Use activity** check box is selected on the Chemistry interface **Settings** window

Click to select the **Keep concentration/activity constant** check box if the species concentration or activity should be treated as constant.

THERMODYNAMIC EXPRESSIONS

The parameters utilized for calculation of thermodynamic mixture and reaction properties are set in this section.

Choose the **User defined** alternative to specify C_p , h , and s directly.

Electrode Reaction

To add an **Electrode Reaction** node () either right-click the **Chemistry** node or in the **Chemistry** toolbar click **Electrode Reaction**.

The **Electrode Reaction** subnode defines the electrode kinetics for a charge transfer reaction that occurs on an electrolyte-electrode interface boundary. Use multiple nodes to model multiple reactions, for instance in mixed potential problems.

This node is available with a Battery Design Module, Corrosion Module, Electrochemistry, Module, Electrodeposition Module, or Fuel Cell & Electrolyzer Module license.

REACTION FORMULA

Formula

Enter an electrode reaction Formula, as a reduction reaction. Use the single letter “e” to symbolize an electron. The delimiter between reactants and products has to be written as “<=>” (without quotation marks). The phase of the species, that is (aq) for aqueous dilute ions, (s) for solids, and (g) for gases can be indicated in the name. The phase is used to select an automatic reference state (see [Reference Concentrations](#)) for computing the equilibrium potential using the Nernst equation. Click **Apply** to make the interface examine the species taking part in the model’s reactions and automatically add the associated [Species](#) features to the Model Builder.

EQUILIBRIUM POTENTIAL

The Equilibrium potential, E_{eq} (SI unit: V), is used in the electrode kinetics expressions in the following section (via the definition of the overpotential), or for setting up primary current distribution potential constraints.

Nernst Equation

After providing the reference electrode potential, the equilibrium potential is calculated using the Nernst equation. The concentrations entered in the [Species Matching](#) section of the **Chemistry** interface will be used to calculate the equilibrium potential. The reference concentrations, defined in the [Reference Concentrations](#) section, will be used to compute the activities in the reaction quotient expression, Q_{r} .

Automatic

This option is only available if the **Calculate mixture properties** check box in the [Calculate Transport Properties](#) section is checked.

The [Species](#) enthalpies and entropies are used to calculate the equilibrium potential of the electrode reaction at the temperature and composition of the system.

If only species enthalpies and entropies at standard state are available, use the [Nernst Equation](#) option instead.

REFERENCE CONCENTRATIONS

The reference concentrations for the species in the reaction can be changed here.

Automatic

The phase indicated when first naming a species will be used to select a suitable reference concentration. The species must indicate the phase in the name when the species is first created.

For aqueous dilute species, denoted by (aq) in their names, the activity is calculated as their concentration divided by 1 M. For gaseous species, denoted by (g) in their names, the activity is calculated as their concentration divided by the standard reference pressure of 1 atm, converted into concentration using the ideal gas law. For solid species, denoted by (s) in their names, the reference concentration is 1. For surface species, denoted by (ads) in their names, the reference surface concentration will be set to the site density configured in the [Species Matching](#) section. Any species not containing a phase in their name, will use a reference state depending on the phase selected under [Mixture Properties](#). If the phase is Gas, the gaseous species reference concentration described above will be used, while if the phase is Liquid, the aqueous species 1 M reference concentration will be used.

User Defined

The reference concentrations for each type of species can be set manually, for aqueous, gaseous, solid, surface, and any other species, respectively.

ELECTRODE KINETICS

See the [Electrode Reaction](#) node in [Shared Physics Features in the Current Distribution Interfaces](#) for a general description of the Electrode Kinetics section.

Electrode reactions in the Chemistry interface support **User-defined**, **Butler-Volmer**, and **Linearized Butler-Volmer** kinetics. For the latter two options, **User-defined** exchange current densities and exchange current densities according to the **Mass Action Law** are supported.

If the equilibrium potential is calculated using **Nernst Equation**, the exponents in the local current density expression are evaluated using the reference overpotential. If

instead the equilibrium potential is calculated using the **Automatic** option, the exponents are evaluated using the overpotential.

HEAT OF REACTION

See the [Electrode Reaction](#) node in [Shared Physics Features in the Current Distribution Interfaces](#) for a general description of the Heat of Reaction section. Electrode Reactions in Chemistry do not support the **Temperature Derivative** option.

By choosing **Automatic**, the **Thermoneutral voltage** parameter, E_{therm} (SI unit: V), will be calculated according to

$$E_{\text{therm}} = -\frac{\Delta_r H}{nF} \quad (6-16)$$

using the [Species](#) enthalpies.



- [Electrode Reactions Theory](#)
 - [Electrode Kinetics Expressions](#)
-

Electrode Reaction Group

To add an **Electrode Reaction Group** node () either right-click the **Chemistry** node or in the **Chemistry** toolbar click **Electrode Reaction Group**.

An **Electrode Reaction Group** is typically used to represent all electrode reactions occurring on one electrode.

Multiple [Electrode Reaction](#) nodes may be added to the **Electrode Reaction Group**. Variables for the sum of all electrode reactions in one group can be used as input in **Electrode Reaction** features in current distribution interfaces.

This node is available with a Battery Design Module, Corrosion Module, Electrochemistry Module, Electrodeposition Module, or Fuel Cell & Electrolyzer Module license.

Reversible Reaction Group







The **Reversible Reaction Group** node () allows input of a large number of reversible reactions in the same table. All reactions are treated in the same way. More than one Reversible Reaction Group can be added to a component.

Add the node from the **Chemistry** toolbar or right-click **Chemistry** and add it from the context menu.

For the case when reaction kinetics data are entered manually into the **Reaction table** and temperature dependent reaction kinetics apply, right-click to add a **Reaction Thermodynamics** subnode or select it from the **Chemistry** toolbar, **Attributes** menu. In it, the Enthalpy of Reaction (J/mol) for each reaction can be specified.

REACTION TABLE

The reversible reactions in the **Reaction table** are numbered and contain reactants, products, and kinetic parameters describing the reaction. Use the buttons under the **Reaction table** to add and sort the reaction details.

- In general, use the **Move Up** (), **Move Down** (), and **Delete** () buttons and the fields under tables to edit the table contents. Or right-click a table cell and select **Move Up**, **Move Down**, or **Delete**.
- The **Add** button () adds default reactant, A, and product, B, with a default. Click the corresponding field to edit the reactant, product, or parameters. After editing the **Species Group** node is also updated. It is created together with the reaction group.
- You can save the parameters to a text file to reuse in other models. Click the **Save to File** button () and enter a **File name** in the **Save to File** dialog box, including the extension .txt. Click **Save** to store the parameters in a text file or in a Microsoft Excel Workbook spreadsheet if the license includes LiveLink™ for Excel®. The information is saved in space-separated columns in the same order as displayed on screen. When saving to Excel, an **Excel Save** dialog box appears where you can specify the sheet and range and whether to overwrite existing data or include a header.
- You can import or load data in files from a spreadsheet program, for example, with the **Load from File** button () and the **Load from File** dialog box that appears. Data must be separated by spaces or tabs. If there is already data in the table, imported parameters are added after the last row. Move or edit rows as needed. If the license includes LiveLink™ for Excel® you can also load parameters from a Microsoft Excel Workbook spreadsheet. Then an **Excel Load** dialog box appears where you can specify the sheet and range and whether to overwrite existing data. It is also possible to import from a spreadsheet containing a separate column for units.

CREATE REACTION AND SPECIES

Enter a reaction number in the **Moving reaction (with the number) from table** text field and click **Create Reaction** to remove the reaction from the **Reaction table** to the model

tree. This introduces a reaction node named after the reaction number and species names and simultaneously creates corresponding species nodes. This action is powerful, since it enables all the editing possibilities available for [Reaction](#) and [Species](#) nodes.

Equilibrium Reaction Group





The **Equilibrium Reaction Group** node () allows for input of a large number of equilibrium reactions in the same table. This node functions in the same way as the [Reversible Reaction Group](#) for reversible reactions.

Add the node from the **Chemistry** toolbar or right-click **Chemistry** and add it from the context menu.

For the case when reaction kinetics data are entered manually into the **Reaction table** and temperature dependent reaction kinetics apply, right-click to add a [Reaction Thermodynamics](#) subnode or select it from the **Chemistry** toolbar, **Attributes** menu. In it, the Enthalpy of Reaction (J/mol) for each reaction can be specified.

REACTION TABLE

The equilibrium reactions in the table are numbered and contain reactants, products, and kinetic parameters describing the reaction. Use the buttons under the **Reaction table** to add and sort the reaction details.

- In general, use the **Move Up** (), **Move Down** (), and **Delete** () buttons and the fields under tables to edit the table contents. Or right-click a table cell and select **Move Up**, **Move Down**, or **Delete**.
- The **Add** button () adds default reactant, A, and product, B, with a default. Click the corresponding field to edit the reactant, product, or parameters. After editing the [Species Group](#) node is also updated. It is created together with the reaction group.
- You can save the parameters to a text file to reuse in other models. Click the **Save to File** button () and enter a **File name** in the **Save to File** dialog box, including the extension `.txt`. Click **Save** to store the parameters in a text file or in a Microsoft Excel Workbook spreadsheet if the license includes LiveLink™ for Excel®. The information is saved in space-separated columns in the same order as displayed on

screen. When saving to Excel, an **Excel Save** dialog box appears where you can specify the sheet and range and whether to overwrite existing data or include a header.

- You can import or load data in files from a spreadsheet program, for example, with the **Load from File** button () and the **Load from File** dialog box that appears. Data must be separated by spaces or tabs. If there is already data in the table, imported parameters are added after the last row. Move or edit rows as needed. If the license includes LiveLink™ for Excel® you can also load parameters from a Microsoft Excel Workbook spreadsheet. Then an **Excel Load** dialog box appears where you can specify the sheet and range and whether to overwrite existing data. It is also possible to import from a spreadsheet containing a separate column for units.

Species Group

The **Species Group** node () contains information on a molecular level about the volumetric species and the surface species present in the model. The **Property for Volumetric Species** or **Property for Surface Species** tables typically collect parameters from when importing CHEMKIN transport files.

This node is automatically added when either the [Reversible Reaction Group](#) or the [Equilibrium Reaction Group](#) is used.

For the case of temperature dependent reaction kinetics, a [Species Thermodynamics](#) subnode is automatically created in which the thermodynamic properties of the species can be specified.

Reaction Thermodynamics

The **Reaction Thermodynamics** subnode (), the Enthalpy of Reaction (J/mol) of each reaction can be specified. This node overrides all the automatically calculated reaction enthalpies as defined in the [Species Thermodynamics](#) subnode.

Add the **Reaction Thermodynamics** node from the **Chemistry** toolbar, **Attributes** menu. Alternatively, right-click a [Reversible Reaction Group](#) or [Equilibrium Reaction Group](#) to add the **Reaction Thermodynamics** subnode.

Species Activity

The **Species Activity** node () creates variables for the activities of all the species/surface species present in the Species Group parent feature. Edit the **Activity coefficient** field in the **Species Activity** or **Surface Species Activity** tables by clicking in these.



Species Activity is a subnode to the [Species Group](#) node. It is automatically generated when nonideality in the fluid mixture is accounted for; when the **Use activity** check box is selected in the **Activity** section.



Species Thermodynamics

The **Species Thermodynamics** node () creates variables for the enthalpies, entropies, and heat capacities for all the species/surface species present in the [Species Group](#) parent feature. The purpose is to compute thermodynamic mixture properties and the heat of reactions.

This node is a subnode to the [Species Group](#) node.



The Nernst–Planck–Poisson Equations Interface

The **Nernst-Planck-Poisson Equations** interface ()¹, found under the **Chemical Species Transport** branch () when adding a physics interface, is a predefined multiphysics interface for modeling transport of electrolyte species without the otherwise common assumption of local electroneutrality. This allows for simulating charge separation that typically arises close to an electrode surface, where ions in the electrolyte are attracted and repelled by unscreened excess charge on the electrode. The charge separation region, also called the diffuse double layer, normally extends a few nanometers away from the electrode surface into the electrolyte. The study of the charge separation is important to applications that consider very thin layers of electrolyte, such as electrochemical capacitors, atmospheric corrosion problems, ion-selective field effect transistors (ISFETs), and nanoelectrochemistry.

The Nernst–Planck–Poisson Equations predefined multiphysics interface adds [The Transport of Diluted Species Interface](#) ()² (with Migration enabled), which solves for the Nernst–Planck equations without charge neutrality, and [The Electrostatics Interface](#) ()³, that solves for the Poisson’s equation.

A [Space Charge Density Coupling](#) ()⁴ multiphysics node is also added. This node computes the local space charge, based on the local concentrations and species charges in the Transport of Diluted Species interface, and adds it to Poisson’s Equation in the Electrostatics interface.

Finally, a [Potential Coupling](#) () multiphysics node is added that applies the potential dependent variable in the Electrostatics interface into the migration term of the Transport of Diluted Species interface.

	<ul style="list-style-type: none"> • The Multiphysics Branch in the <i>COMSOL Multiphysics Reference Manual</i>. • The Transport of Diluted Species Interface • The Electrostatics Interface • Space Charge Density Coupling • Potential Coupling
	<p><i>Diffuse Double Layer</i>: Application Library path Battery_Design_Module/General_Electrochemistry/ diffuse_double_layer</p>

The Electrophoretic Transport Interface

The **Electrophoretic Transport (el)** interface (🧪), found under the **Chemical Species Transport** branch (🧪), is used to solve for the electrophoretic transport of an arbitrarily number of species in water-based system, subject to potential gradients. The species transported can be any combination of weak and strong acids and bases, ampholytes, and uncharged species. The transport of masses and charge is based on the Nernst–Planck equations for molecular transport, in combination with electroneutrality, dissociation equilibria for weak acids, bases, and ampholytes as well as the water autoionization reaction.

The physics interface can simulate most forms of electrophoresis modes, such as zone electrophoresis, isotachopheresis, isoelectric focusing, and moving boundary electrophoresis.

Gel electrophoresis can be simulated by the inclusion of immobile charged species.

The interface supports simulation in 1D, 2D, and 3D as well as for axisymmetric components in 1D and 2D.

The dependent variables are the electrolyte potential, and the molar concentrations of the included species, added individual by each species node in the model tree.

SETTINGS

The **Label** is the default physics interface name.

The **Name** is used primarily as a scope prefix for variables defined by the physics interface. Refer to such physics interface variables in expressions using the pattern `<name>.<variable_name>`. In order to distinguish between variables belonging to different physics interfaces, the `name` string must be unique. Only letters, numbers, and underscores (`_`) are permitted in the **Name** field. The first character must be a letter.

The default **Name** (for the first physics interface in the model) is `el`.

DOMAIN SELECTION

If any part of the model geometry should not partake in the mass transfer model, remove that part from the selection list.

OUT-OF-PLANE THICKNESS



For 2D components, enter a value or expression for the out-of-plane **Thickness** d (SI unit: m). The value of d determines the size of the domain perpendicular to the modeled 2D cross section. This value yields, for example, the correct total current when the current density is obtained from a 2D simulation.

CROSS SECTIONAL AREA



For 1D components, enter a **Cross sectional area** A_c (SI unit: m^2) to define a parameter for the area of the geometry perpendicular to the 1D component. The value of this parameter is used, among other things, to automatically calculate the total current from the current density vector. The analogy is valid for other fluxes. The default is $1 m^2$.

TRANSPORT MECHANISMS

Mass transport due to diffusion and migration is always included. Use the check boxes available under **Additional transport mechanisms** to control other transport mechanisms.

- By default, the **Convection** check box is selected. Clear the check box to disable convective transport.
- The **Mass transfer in porous media** check box activates functionality specific to species transport in porous media. When selected, the Porous Matrix Properties node can be added to a domain to specify the electrolyte volume fraction and tortuosity, and the Effective Transport Parameter Correction sections are enabled in the species nodes.

CONSISTENT STABILIZATION

To display this sections, click the **Show More Options** button () and select **Stabilization** in the **Show More Options** dialog box.

- When the **Crosswind diffusion** check box is selected, a weak term that reduces spurious oscillations is added to the transport equation. The resulting equation system is always nonlinear.
- For both **Streamline diffusion** and **Crosswind diffusion**, select an **Equation residual**. **Approximate residual** is the default and means that derivatives of the diffusivity are

neglected. This setting is usually accurate enough and is computationally faster. If required, select **Full residual** instead.

INCONSISTENT STABILIZATION

To display this section, click the **Show More Options** button () and select **Stabilization** in the **Show More Options** dialog box. By default, the **Isotropic diffusion** check box is not selected because this type of stabilization adds artificial diffusion and affects the accuracy of the original problem. However, this option can be used to get a good initial guess for under-resolved problems.

ADVANCED SETTINGS

To display this section, click the **Show More Options** button () and select **Advanced Physics Options** in the **Show More Options** dialog box. Normally these settings do not need to be changed. Select a **Convective term — Nonconservative form** (the default) or **Conservative form**. Use the conservative formulation for compressible flow.

DISCRETIZATION

To display all settings available in this section, click the **Show More Options** button () and select **Advanced Physics Options** in the **Show More Options** dialog box.

The concentration variables are set to use Linear elements by default.

The potential variable is set to use Quadratic elements by default.

The **Compute boundary fluxes** check box is activated by default so that COMSOL Multiphysics computes predefined accurate boundary flux variables. When this option is checked, the solver computes variables storing accurate boundary fluxes from each boundary into the adjacent domain.

If the check box is cleared, the COMSOL Multiphysics software instead computes the flux variables from the dependent variables using extrapolation, which is less accurate in postprocessing results but does not create extra dependent variables on the boundaries for the fluxes.

The flux variables affected in the interface are:

- $\langle \text{name} \rangle .nI1$, where $\langle \text{name} \rangle$ is the name of the interface (default is $e1$), set on the interface top node. This is the normal electrolyte current density.
- $\langle \text{name} \rangle .ntflux_{\langle \text{species_name} \rangle}$ is the **Species name** (see [Common Settings for the Species Nodes in the Electrophoretic Transport Interface](#) below). This is the normal total flux for each species.

Also the **Apply smoothing to boundary fluxes** check box is available if the previous check box is checked. The smoothing can provide a more well-behaved flux value close to singularities.

For details about the boundary fluxes settings, see [Computing Accurate Fluxes](#) in the *COMSOL Multiphysics Reference Manual*.

Regarding the **Value type when using splitting of complex variables**, see [Splitting Complex-Valued Variables](#) in the *COMSOL Multiphysics Reference Manual*.

DEPENDENT VARIABLES

The dependent variable name for the electrolyte potential variable is `phi1` by default.

The name of the concentration dependent variables are named as `e1.xxx`, where `e1` is the name of the interface as set above, and the `xxx` string is controlled by the **Species name** setting on the individual species nodes.

FURTHER READING



- [Theory for the Electrophoretic Transport Interface](#)
- [Numerical Stabilization](#) in the *COMSOL Multiphysics Reference Manual*.
- In the *COMSOL Multiphysics Reference Manual*, see [Table 2-4](#) for links to common sections and [Table 2-5](#) for common feature nodes. You can also search for information: press F1 to open the **Help** window or Ctrl+F1 to open the **Documentation** window.

Common Settings for the Species Nodes in the Electrophoretic Transport Interface

The interface features the following species nodes, applicable on the domain level:

- [Ampholyte](#)
- [Fully Dissociated Species](#)
- [Uncharged Species](#)
- [Weak Acid](#)
- [Weak Base](#)

Each species node add a dependent variable for the concentration. The initial and boundary condition, as well as adding additional source reaction terms, for each species concentration is controlled by adding subnodes to the species nodes:

- [Concentration](#)
- [Flux](#)
- [Inflow](#)
- [Initial Concentration](#)
- [No Flux](#)
- [Outflow](#)
- [Species Source](#)

The [Ampholyte](#), [Weak Acid](#), and [Weak Base](#) nodes are dissociation species and may define an arbitrary number of dissociation steps. Each dissociation step is defined by its pK_a (the acid equilibrium constant) parameter. For the weak bases the pK_a refers to the acid constant of the conjugate acid. Each dissociation step adds one additional subspecies concentration variable so that the concentration dependent variable represents the sum of all subspecies, and initial and boundary conditions are defined with respect to this total concentration.

All species node have a setting for the **Species name**, which needs to be unique. The species name is used for naming of all related variables of the species. For species nodes not defining any subspecies, the concentration variables are named as `<name>.c_<species_name>` where `<name>` is the name of the interface (default is `e1`), set on the interface top node, and `<species_name>` is the **Species name**. For dissociation species nodes defining multiple subspecies, the concentration nodes are named as `<name>.c<X>_<species_name>` where `<X>` is the integer from 1 up to the total number of subspecies. Note that the [Solvent](#) node automatically defines the concentration variables for protons (`<name>.cH`) and hydroxide ions (`<name>.cOH`).

All species except the [Uncharged Species](#) carry charge and contribute to the total electrolyte current which is used in the equation for solving the electrolyte potential.

The **Immobile Species** check box can be used to lock the concentration of a species, to, for instance, define the immobile charges in an ion-selective membrane or a gel. When the check box is enabled the concentration of the species is not added as a dependent variable to the model; instead the concentration will be set to the value provided in the **Concentration** field. The contribution to the electrolyte current for immobile species is zero.

Diffusion and Migration Settings

All species, except when the **Immobile Species** check box has been enabled, may be transported by diffusion, and charged species are also transported by migration in the electric field.

For dissociation species you may choose to set the transport parameters to be the **Same for all species** appearing in the different dissociation steps, or you may use **Individual** settings for each subspecies.

Typically the mobilities and diffusivities for small species are related by the **Nernst-Einstein relation**, and when this relation is enabled you can choose whether to specify either the **Diffusivity** (SI unit: m^2/s) or the **Mobility** (SI-unit: $\text{s}\cdot\text{mol}/\text{kg}$). The **Debye-Hückel-Henry** relation is commonly used for larger molecules, such as proteins.

Note: There are other definitions of the migration transport equations in the literature which use mobilities expressed in $\text{m}^2/(\text{V}\cdot\text{s})$, whereas COMSOL Multiphysics uses $\text{s}\cdot\text{mol}/\text{kg}$. To convert mobilities expressed in $\text{m}^2/(\text{V}\cdot\text{s})$ to the corresponding values in $\text{s}\cdot\text{mol}/\text{kg}$, you typically divide by the Faraday constant, F_{const} (about 96,485 C/mol).

EFFECTIVE TRANSPORT PARAMETER CORRECTION

If **Mass transfer in porous media** is enabled on the interface top node, you may use the settings of this section in the species nodes to account for the changed mass transport in a porous domain due to the lowered porosity and the increased tortuosity.

The default correction model is **Bruggeman**, which multiplies the diffusivity and mobility values by the porosity to the power of 1.5. The porosity of a domain is set by the [Porous Matrix Properties](#) node.

IONIC STRENGTH CONTRIBUTION

To display this section, click the **Show More Options** button () and select **Advanced Physics Options** in the **Show More Options** dialog box.

The **Debye-Hückel-Henry** relation makes use of the ionic strength for calculating the species mobility from the diffusivity. All charged species contribute to the ionic strength, either assuming the species contributing to an **Ideal solution** or by using the **Linderstrøm-Lang** assumption. The latter is usually used for macromolecules.

Domain, Boundary, and Pair Nodes for the Electrophoretic Transport Interface

The interface has the following domain, boundary, and pair nodes, listed in alphabetical order, available from the **Physics** ribbon toolbar (Windows users), **Physics** context menu (Mac or Linux users), or by right-clicking to access the context menu (all users).



To add a node, go to the **Physics** toolbar, no matter what operating system you are using. Subnodes are available by clicking the parent node and selecting it from the **Attributes** menu.

- Ampholyte
- Concentration
- Current
- Current Density
- Current Source
- Flux
- Fully Dissociated Species
- Inflow
- Initial Concentration
- Initial Potential
- Insulation
- No Flux
- Outflow
- Porous Matrix Properties
- Potential
- Protein
- Species Source
- Solvent
- Uncharged Species
- Weak Acid
- Weak Base



For axisymmetric components, COMSOL Multiphysics takes the axial symmetry boundaries (at $r = 0$) into account and automatically adds an **Axial Symmetry** node that is valid on boundaries representing the symmetry axis.



In the *COMSOL Multiphysics Reference Manual*, see [Table 2-4](#) for links to common sections and [Table 2-5](#) for common feature nodes. You can also search for information: press F1 to open the **Help** window or Ctrl+F1 to open the **Documentation** window.

Solvent

The settings of this node are used to define the properties of the aqueous solvent.

If Convection is enabled on the interface top node, you can specify the **Velocity field** (m/s) as user defined input using analytical expressions or the velocity field variables solved for by a separate physics interface.

The Solvent node automatically defines the concentration variables and for protons (<name>.cH) and hydroxide ions (<name>.cOH), and the corresponding flux expressions. See [Diffusion and Migration Settings](#) for how to set up the transport parameters for the proton and hydroxide ions.

In the **Solvent Properties** section you can modify the **Dynamic viscosity** (Pa·s) and **Relative permittivity** (unitless) values. The **Built in** and default values are applicable to water. These parameters are used when calculating mobilities according to the **Debye-Hückel-Henry** relation in the species nodes.

In the **Water Self-ionization** section you can change the default **Built in** expression for the **Water self-ionization constant**, pK_w (unitless), to any user-defined expression.

Porous Matrix Properties

Use this node, available if **Mass transfer in porous media** has been enabled on the interface top-node, to define the **Porosity** (electrolyte volume fraction) and **Tortuosity** of a domain.

The porosity should be a number between 0 and 1.

Fully Dissociated Species

Use this node to define a fully dissociated charged species, such as strong bases and acids.

The **Charge number**, Z_0 (unitless), defines the species charge.

See also [Common Settings for the Species Nodes in the Electrophoretic Transport Interface](#) and [Diffusion and Migration Settings](#).

Uncharged Species

Use this node to define a species that does not carry any charge, nor is impacted by the electric field.

See also [Common Settings for the Species Nodes in the Electrophoretic Transport Interface](#) and [Diffusion and Migration Settings](#).

Weak Acid

The **Weak acid** node supports multiple dissociation steps, where the acid of the first dissociation step is uncharged.

The species may be either **Monoprotic**, subject to one dissociation step only, or **Polyprotic**. For the latter case any **Number of dissociation steps** larger than one may be used.

See also [Common Settings for the Species Nodes in the Electrophoretic Transport Interface](#) and [Diffusion and Migration Settings](#).

Weak Base

The **Weak base** node supports multiple dissociation steps, where the base of the last dissociation step is uncharged.

The species may be either **Monoprotic**, subject to one dissociation step only, or **Polyprotic**. For the latter case any **Number of dissociation steps** larger than one may be used.

Note that the pK_a refers to the acid constant of the conjugate acid of the weak base.

See also [Common Settings for the Species Nodes in the Electrophoretic Transport Interface](#) and [Diffusion and Migration Settings](#).

Ampholyte

Use the **Ampholyte** node generically to define any species where the average charge depends on the pH of the solution. The **Dissociation model** may be based either on a set of **Equilibrium constants** or an **Average charge**.

When using the **Equilibrium constants** the **Base charge in last dissociation step**, Z_0 (unitless), needs to be set.

The **Average charge**, \bar{Z} (unitless) parameter is typically a function of pH and may be added as an analytical function or an interpolation polynomial under **Definitions**. The average squared charge, used in the electrolyte potential equation, is calculated automatically based on \bar{Z} .

See also [Common Settings for the Species Nodes in the Electrophoretic Transport Interface](#) and [Diffusion and Migration Settings](#).

Protein

Use the **Protein** node to define macromolecules. The features of the Protein node are similar to the [Ampholyte](#) node, but with the default settings applicable for larger molecules.

See also [Common Settings for the Species Nodes in the Electrophoretic Transport Interface](#) and [Diffusion and Migration Settings](#).

Current Source

To make this node available, click the **Show More Options** button () and select **Advanced Physics Options** in the **Show More Options** dialog box.

Use this node to add a current source in a domain. A current source may appear in a domain in homogenized porous electrode modeling, but should normally not be used.

Initial Potential

Use this node to specify the **Initial Value** of the electrolyte potential for the solver.

Current

The **Current** boundary condition sets the total current or average current density over a boundary. It will set a constant electrolyte potential along the given boundary, which satisfies the current value setting.

This node is typically used to model electrode surfaces or boundaries facing an electrolyte reservoir (containing an electrode).

When using the **Total current** option in 1D or 2D, the boundary area is based either on the **Cross sectional area** (1D) or the **Out-of-Plane thickness** (2D) properties, set on the physics interface top node.

Current Density

Use the **Current Density** node to specify the current density distribution along a boundary.

This node is typically used to model electrode surfaces where the electrode kinetics depends on the electrolyte potential.

Note that using this node in 2D or 3D may result in an uneven potential distribution along the boundary. To mitigate such effects you may use the [Current](#) node instead.

Insulation

The **Insulation** boundary condition describes the walls of a cell or the boundaries of the cell that do not face an electrode (or a reservoir containing an electrode). The boundary condition imposes the following equation:

$$\mathbf{i}_l \cdot \mathbf{n} = 0$$

Potential

Add the **Potential** node on a boundary to set a fixed potential. This node is typically used to model electrode surfaces or boundaries facing an electrolyte reservoir.

The node sets the potential in the electrolyte, ϕ_l , to be equal to the **Boundary electrolyte potential**, $\phi_{l, \text{bnd}}$ (SI unit: V).

CONSTRAINT SETTINGS

To display this section, click the **Show More Options** button () and select **Advanced Physics Options** in the **Show More Options** dialog box.

Species Source

To make this node available, click the **Show More Options** button () and select **Advanced Physics Options** in the **Show More Options** dialog box.

This node may be added as a subnode to any species node. See also [Common Settings for the Species Nodes in the Electrophoretic Transport Interface](#).

In order to account for consumption or production of species, for example in porous electrodes or as a result of reversible reactions, the **Species Source** node adds source terms expressions S (SI unit: $\text{mol}/(\text{m}^3 \cdot \text{s})$) to the right-hand side of the transport equation of the parent species.

Initial Concentration

This node may be added as a subnode to any species node. See also [Common Settings for the Species Nodes in the Electrophoretic Transport Interface](#).

This node specifies the initial value for the **Concentration**, c (mol/m³), of the parent species. This value serves as the initial condition for a transient simulation. The value also serves as a start guess for stationary problems.

You can use spatially dependent functions (such as smoothed step functions) available under **Definitions** when defining the **Concentration** expression to specify different concentrations in different parts of the geometry. You can also use additional **Initial Values** node and modify the **Selection** to set different values for different domains.

Concentration

This node may be added as a subnode to any species node. See also [Common Settings for the Species Nodes in the Electrophoretic Transport Interface](#).

This condition node adds a boundary condition for the parent species concentration. Use the node to, for instance, specify the inlet concentration at the boundary facing an electrolyte reservoir.

No Flux

This node may be added as a subnode to any species node. See also [Common Settings for the Species Nodes in the Electrophoretic Transport Interface](#).

This node is the default boundary condition on exterior boundaries. It represents boundaries where no mass flows in or out of the boundaries. Hence, the total flux is zero.

Flux

This node may be added as a subnode to any species node. See also [Common Settings for the Species Nodes in the Electrophoretic Transport Interface](#).

This node can be used to specify the species inward flux across a boundary. The flux can represent a flux from or into a much larger surrounding environment, a phase change, or a flux due to chemical reactions.

INWARD FLUX

Enter a value or expression for the species mass flux J_0 . Use a minus sign when specifying a flux directed out of the system.

External convection

Set **Flux type** to **External convection** to prescribe a flux to or from an exterior domain (not modeled) assumed to include convection. The exterior can for example include a forced convection to control the temperature or to increase the mass transport. In this case the prescribed mass flux corresponds to

$$J_0 = k_c(c_b - c)$$

where k_c is a mass transfer coefficient and c_b is the bulk concentration, the typical concentration far into the surrounding exterior domain.

Inflow

This node is available when you select the **Convection** check box on the physics interface **Settings** window.

Use this node to specify the species concentrations at an inlet boundary.

BOUNDARY CONDITION TYPE

The option **Concentration constraint** constrains the concentration values on the boundary by the use of pointwise constraints. When using this option the boundary condition is identical to the [Concentration](#) node.



The other option, **Flux (Danckwerts)** can be more stable and fast to solve when high reaction rates are anticipated in the vicinity of the inlet. Oscillations on the solutions can also be avoided in such cases. The latter condition uses a flux boundary condition based on the velocity across the boundary and the concentration values.

Outflow

Set this condition at outlets where species are transported out of the model domain by migration or fluid motion. It is assumed that migration and convection are the dominating transport mechanisms across outflow boundaries, and therefore that diffusive transport can be ignored; that is:

$$\mathbf{n} \cdot (-D\nabla c) = 0$$

The Surface Reactions Interface

The **Surface Reactions (sr)** interface () , found under the **Chemical Species Transport** branch () when adding a physics interface, is used to model the chemical reactions of surface and bulk species on a boundary. Surface species can be transported in the tangential direction of the surface by Fick's law whereas bulk species are assumed to be immobile on the surface.

The physics interface supports simulation of surface reactions on boundaries in 1D, 2D, and 3D as well as for axisymmetric components in 1D and 2D. The dependent variables are the surface concentrations, $c_{s,i}$ (SI unit: mol/m²) and the bulk concentrations, $c_{b,i}$ (SI unit: mol/m²).

When this physics interface is added, these default nodes are also added to the **Model Builder** — **Surface Properties**, **No Flux**, and **Initial Values**. Then, from the **Physics** toolbar, add other nodes that implement, for example, boundary conditions. You can also right-click **Surface Reactions** to select physics features from the context menu.

SETTINGS



The **Label** is the default physics interface name.



The **Name** is used primarily as a scope prefix for variables defined by the physics interface. Refer to such physics interface variables in expressions using the pattern <name>.<variable_name>. In order to distinguish between variables belonging to different physics interfaces, the name string must be unique. Only letters, numbers, and underscores (_) are permitted in the **Name** field. The first character must be a letter.

The default **Name** (for the first physics interface in the model) is sr.

DEPENDENT VARIABLES

Add or remove species and also change the names of the dependent variables that represent the species concentrations. Note that the names can be changed but the names of fields and dependent variables must be unique within a model.

Enter the **Number of surface species**. Use the **Add surface concentration** () and **Remove surface concentration** () buttons as needed. The same number of **Surface concentrations** cs, cs2, cs3, ... are then listed in the table.

Enter the **Number of bulk species**. Use the **Add bulk concentration** () and **Remove bulk concentration** () buttons as needed. The same number of **Bulk concentrations** cb, cb2, cb3, ... are then listed in the table.

DISCRETIZATION

To display all settings available in this section, click the **Show More Options** button () and select **Advanced Physics Options** in the **Show More Options** dialog box.

CONSISTENT AND INCONSISTENT STABILIZATION

To display these sections, click the **Show More Options** button () and select **Stabilization** in the **Show More Options** dialog box.

By default the **Compensate for boundary stretching** check box is selected for the [Surface Properties](#) node. This section is then used to stabilize the tangential mesh velocity term.

When the **Compensate for boundary stretching** check box is cleared (not selected), and for fixed geometries or moving geometries, the stabilization has no effect.

See [Surface Reaction Equations on Deforming Geometries](#) for more information.

	<ul style="list-style-type: none">• Boundary, Edge, Point, and Pair Nodes for the Surface Reactions Interface• Theory for the Surface Reactions Interface
---	--

	<p><i>Soluble Lead–Acid Redox Flow Battery</i>: Application Library path Battery_Design_Module/Flow_Batteries/pb_flow_battery</p>
---	--

Boundary, Edge, Point, and Pair Nodes for the Surface Reactions Interface

The [Surface Reactions Interface](#) has these boundary, edge, point, and pair nodes, listed in alphabetical order, available from the **Physics** ribbon toolbar (Windows users),

Physics context menu (Mac or Linux users), or right-click to access the context menu (all users).



In general, to add a node, go to the **Physics** toolbar, no matter what operating system you are using. Subnodes are available by clicking the parent node and selecting it from the **Attributes** menu.

These nodes are described in this section:

- [Initial Values](#)
- [Reactions](#)
- [Surface Concentration](#)
- [Surface Properties](#)

All other available nodes are described for the Transport of Diluted Species interface. See [Domain, Boundary, and Pair Nodes for the Transport of Diluted Species Interface](#).



In the *COMSOL Multiphysics Reference Manual* see [Table 2-4](#) for links to common sections and [Table 2-5](#) to common feature nodes. You can also search for information: press F1 to open the **Help** window or Ctrl+F1 to open the **Documentation** window.

Surface Properties

Use the **Surface Properties** node to define the density of sites, the site occupancy number, and the surface diffusion.

SPECIES CONSERVATION ON DEFORMING GEOMETRY

The **Compensate for boundary stretching** check box is selected by default. Click to clear the check box if required.

SITES

Enter a value or expression for the **Density of sites** Γ_s (SI unit: mol/m²). The default is 2×10^{-5} mol/m².

Enter a **Site occupancy number** σ_i (dimensionless), indicating how many surface sites a surface species block upon adsorption.

This section is only present if the number of surface species is 1 or higher.

SURFACE DIFFUSION

Select a **Surface material** from the list. The default is **None**.

For each surface concentration species, the default **Diffusion coefficient** D_i (SI unit: m^2/s) is **User defined**. Select **Isotropic**, **Diagonal**, **Symmetric**, or **Full** depending on the characteristics of the surface, and then enter values or expressions in the field or matrix.

This section is only present if the number of surface species is 1 or higher.

BULK SPECIES

For each bulk species enter the **Molar mass** M_i (SI unit: kg/mol) and the **Density** ρ_i (SI unit: kg/m^3). The default molar mass is $0.144 \text{ kg}/\text{mol}$ and the default density is $5320 \text{ kg}/\text{m}^3$.

This section is only present if the number of bulk species is 1 or higher.



Surface Reaction Equations on Deforming Geometries

Initial Values

The **Initial Values** node allows the initial value or guess for the surface and bulk concentrations.

INITIAL VALUES

Based on the number of surface species and number of bulk species entered for the physics interface under Dependent Variables section, enter values for the same number of **Surface concentration** cs , $cs2$, $cs3$, ... (SI unit: mol/m^2) and **Bulk concentration** cb , $cb2$, $cb3$, ... (SI unit: mol/m^2) in each field.

Reactions

The **Reactions** node adds rate expression terms to the species transport equations in order to account for consumption or production of species due to reactions.

REACTION RATE FOR SURFACE SPECIES

Add a reaction rate expression, $R_{s,cs1,cs2...}$ (SI unit: $\text{mol}/(\text{m}^2 \cdot \text{s})$), for each surface species taking part in a surface reaction.

This section is only present if the number of surface species is 1 or higher.

REACTION RATE FOR BULK SPECIES

Add a reaction rate expression, $R_{b,cb1,cb2\dots}$ (SI unit: mol/(m²·s)), for each bulk species taking part in a surface reaction.

This section is only present if the number of bulk species is 1 or higher.

Surface Concentration

Use the **Surface Concentration** node to set the surface concentrations for one or more species on an edge (3D components) or a point (2D and 2D axisymmetric components).

SURFACE CONCENTRATION

Select each species check box as needed and enter a value or expression for each species concentration, $c_{s,0,cs1,cs2\dots}$ (SI unit: mol/(m²·s)).

CONSTRAINT SETTINGS

To display this section, click the **Show More Options** button () and select **Advanced Physics Options** in the **Show More Options** dialog box.

The Reacting Flow Interfaces

The Battery Design Module includes predefined multiphysics interfaces that couple fluid with mass transport and reactions.

Selecting any of these interfaces under the **Chemical Species Transport>Reacting Flow** or **Chemical Species Transport>Reacting Flow in Porous Media** branches of the **Model Wizard** or **Add Physics** windows, adds a fluid flow interface and either a **Transport of Diluted Species** or **Transport of Concentrated Species** interface to the Model Builder.

In addition, the Multiphysics node **Reacting Flow** is added. The **Reacting Flow** node predefines and controls the couplings between the mass and fluid transport in order to facilitate easy set up of models.

In this section:

- [The Reacting Laminar Flow Interface](#)
- [The Reacting Flow Coupling Feature](#)
- [Physics Interface Features](#)

The Reacting Laminar Flow Interface

The **Reacting Laminar Flow** () multiphysics interface is used to simulate laminar flow coupled to species transport in a gas or liquid.

It combines the **Laminar Flow**, and **Transport of Concentrated Species** interfaces. The **Reacting Flow** multiphysics coupling, which is added automatically, couples fluid flow and mass transport. The fluid flow can either be free flow or flow in a porous medium. The species transport supports both a mixture, where the concentrations are of comparable order of magnitude, and low-concentration solutes in a solvent.

The interface can be used for stationary and time-dependent analysis in 2D, 2D axial symmetry, and 3D.

ON THE CONSTITUENT PHYSICS INTERFACES

The equations solved by the **Laminar Flow** interface are the Navier–Stokes equations for conservation of momentum and the continuity equation for conservation of mass. A **Fluid Properties** feature is active by default on the entire interface selection. A **Porous Medium** feature can be added in order to model flow in porous media by solving the Brinkman equations.

The **Transport of Concentrated Species** interface solves for an arbitrary number of mass fractions. The species equations include transport by convection, diffusion and, optionally, migration in an electric field.



The **Reacting Laminar Flow** interface triggers pseudo time stepping for the flow equations when **Use pseudo time stepping for stationary equation form** in the **Fluid Flow** interface is set to **Automatic from physics**.

The Reacting Flow Coupling Feature

Use the **Reacting Flow** () multiphysics coupling to simulate mass transport and reactions in a gas or liquid mixture where the fluid flow can be dependent on the mixture composition. When a **Heat Transfer** and a **Chemistry** interface are selected, use this coupling to simulate heat transfer additionally to mass transport and reactions.

The coupling adds the heat source of reaction when a heat transfer interface is selected. No additional heat source needs to be defined to account for it in the heat transfer interface. It also accounts for the multiphysics stabilization terms, for work due to pressure forces and viscous dissipation.

Select a **Fluid Flow** interface and a **Species transport** interface to couple fluid flow with mass transport. **Chemistry** and **Heat Transfer** are optional. They can be set to **None** when the coupling is used to simulate isothermal mixtures.

When a **Chemistry** interface is selected and **Heat Transfer** is set to **None**, fluid properties are taken from the Chemistry interface. Set the **Temperature** to evaluate the fluid properties synchronized with all the physics interfaces at the given temperature.

Select a **Chemistry** interface and **Heat Transfer** interface in order to account for the heat of reaction, enthalpy diffusion, viscous heating and mass fluxes contributing to the heat and energy balance.



When **Chemistry** is set to **None** and a **Heat Transfer** interface is selected, the coupling is solved in the same way as when no Heat Transfer interface is selected. Thermodynamic properties are required by the Heat Transfer interface.



The pressure, velocity, and temperature variables of the **Reacting Flow** coupling node are set to the **Common Model Input** values of the **Default Model Inputs** node on the complementary selection, that is, all domains except those from the **Selection** list. It allows to couple multiple fluid flow or transport of species interfaces with a single heat transfer interface. See [Default Model Inputs](#) in the *COMSOL Multiphysics Reference Manual* for details.

DOMAIN LEVEL SYNCHRONIZATION

The **Reacting Flow** coupling synchronizes the features from a Chemistry interface, Heat Transfer interface, Single-Phase Flow, or Brinkman Equations, interface and a Transport of Concentrated Species interface. When the Chemistry interface is not selected, the density in the Single-Phase Flow interface is automatically synchronized to the one defined by the Transport of Concentrated Species interface.

The velocity field used by the Transport of Concentrated Species interface and Heat Transfer interface is synchronized to the one computed in the Single-Phase Flow interface.

When a Chemistry interface is selected, the **Reacting Flow** coupling synchronizes the definition of the thermal conductivity, density, heat capacity, enthalpy, and dynamic viscosity with the other coupled physics interfaces. The reference temperature is taken from the Heat Transfer interface.

THE STEFAN VELOCITY

The **Reacting Flow** coupling feature automatically couples mass transfer on boundaries and applies a corresponding velocity contribution for the flow. Prescribing a net mass boundary flux in the **Transport of Concentrated Species** interface, either using a **Flux** or **Mass Fraction** feature, the **Reacting Flow** feature computes [The Stefan Velocity](#) and applies this in **Wall** features using the same selection.

MASS TRANSFER TO OTHER PHASES IN POROUS MEDIA

When coupled to the **Brinkman Equations** interface, the **Reacting Flow** node automatically computes the net mass source or sink in a **Reactions** (when **Mass transfer to other phases is enabled**) or Porous Electrode Coupling node in the **Transport of Concentrated Species** interface and adds the corresponding source/sink to the momentum equations of the **Fluid and Matrix Properties** domains.

TURBULENT MASS TRANSFER

When a turbulence model is used, the **Reacting Flow** coupling applies turbulence modeling for the mass transport in the following manners:

- Turbulent heat transfer and mass transport are added, defined from the turbulent viscosity and a turbulent Schmidt number (for more information, see [Turbulent Mass Transport Models](#)).
- Temperature and mass transport wall functions. When a turbulence model using wall functions is used for the fluid flow, the Reacting Flow coupling automatically adds wall functions for the temperature and mass transport on the same boundaries (for more information, see [Mass Transport Wall Functions](#)).

SETTINGS

The **Label** is the default multiphysics coupling feature name.

The **Name** is used primarily as a scope prefix for variables defined by the coupling node. Refer to such variables in expressions using the pattern `<name>.<variable_name>`. In order to distinguish between variables belonging to different coupling nodes or physics interfaces, the `name` string must be unique. Only letters, numbers, and underscores (`_`) are permitted in the **Name** field. The first character must be a letter.

The default **Name** (for the first multiphysics coupling feature in the model) is `nirf1`.

DOMAIN SELECTION

The **Reacting Flow** coupling is automatically defined on the intersection of the selections for the coupled interfaces. When modeling porous media transport a **Porous Medium** feature, applied on the same domains, is needed in all coupled transport interfaces. **Reacting Flow** coupling supports porous media transport in **Fluid flow** and **Species transport** interfaces.

The **Selection** list displays the domains where the coupling feature is active.

COUPLED INTERFACES

This section defines the physics involved in the multiphysics coupling. The **Fluid flow**, **Species transport**, **Chemistry**, **Heat Transfer** lists include all applicable physics interfaces.

The default values depend on how this coupling node is created.

- If it is added from the **Physics** ribbon (Windows users), **Physics** contextual toolbar (Mac and Linux users), or context menu (all users), then the first physics interface of each type in the component is selected as the default.
- If it is added automatically when a multiphysics interface is chosen in the **Model Wizard** or **Add Physics** window, then the two participating physics interfaces are selected.

You can also select **None** from a list to uncouple the node from a physics interface.

Click the **Go to Source** buttons () to move to the main physics interface node for the selected physics interface.

Click the **Show or Hide Physics Properties Settings** button () to toggle the display of physics properties settings affecting the coupling feature. When a turbulence model is used, turbulent heat and mass transfer is automatically accounted for (see the settings in the **Turbulence** section below). Using Reacting Flow, the heat and mass transfer treatment at walls follows that applied for the fluid flow. Therefore the **Wall treatment** setting is also displayed when using a turbulence model. For more information on turbulent mass transfer at walls, see the section [Mass Transport Wall Functions](#) in the *CFD Module User's Guide*.



If a physics interface is deleted and then added to the model again, then in order to reestablish the coupling, you need to choose the physics interface again from the **Fluid flow, Species transport, Chemistry** and **Heat Transfer** lists. This is applicable to all multiphysics coupling nodes that would normally default to the once present interface. See [Multiphysics Modeling Workflow](#) in the *COMSOL Multiphysics Reference Manual*.

MASS TRANSPORT TURBULENCE MODEL

When the fluid flow interface uses a turbulence model, select an option from the **Mass transport turbulence model** list — **Kays-Crawford**, **High Schmidt Number**, or **User-defined turbulent Schmidt number**.

For **User-defined turbulent Schmidt number**, enter a **Turbulent Schmidt number** Sc_T (dimensionless).

The turbulent mass transfer added to the mass fraction equations is defined as

$$N_{i,T} = -\frac{\mu_T}{Sc_T} \nabla \omega_i$$

where μ_T is the turbulent viscosity defined by the flow interface, and the turbulent Schmidt number, Sc_T , depends on the **Mass transport turbulence model** used.

HEAT TRANSFER TURBULENCE MODEL

This section is available when a Heat Transfer interface is selected and the fluid flow interface uses a turbulence model. Select an option from the **Heat transport turbulence model** list: **Kays-Crawford** (the default), **Extended Kays-Crawford**, or **User-defined turbulent Prandtl number**.

For **Extended Kays-Crawford**, enter a **Reynolds number at infinity** Re_{inf} (dimensionless).

For **User-defined turbulent Prandtl number**, enter a **Turbulent Prandtl number** Pr_T (dimensionless).

When the flow interface uses a RANS turbulence model, the conductive heat flux is defined as

$$q = -(k + k_T) \nabla T$$

with the turbulent thermal conductivity defined as

$$k_T = \frac{\mu_T C_p}{Pr_T}$$

where μ_T is defined by the flow interface, and Pr_T depends on the **Heat transport turbulence model**. See [Turbulent Conductivity](#) for details.

The **Turbulence model type** used by the fluid flow interface can be displayed by selecting the **Show or Hide Physics Property Settings** button at the right of the **Fluid flow** list.

Physics Interface Features

Physics nodes are available from the **Physics** ribbon toolbar (Windows users), **Physics** context menu (Mac or Linux users), or right-click to access the context menu (all users).



In general, to add a node, go to the **Physics** toolbar, no matter what operating system you are using.

LAMINAR FLOW

The available physics features for The Laminar Flow interface are listed in the section [Domain, Boundary, Pair, and Point Nodes for Single-Phase Flow](#) in the *COMSOL Multiphysics Reference Manual*.

TRANSPORT OF CONCENTRATED SPECIES

The available physics features for The Transport of Concentrated Species interface are listed in the section [Domain, Boundary, and Pair Nodes for the Transport of Concentrated Species Interface](#).

The Reacting Flow in Porous Media Interfaces

The Battery Design Module includes two predefined multiphysics interface that couples fluid flow in porous media with mass transport and reactions in porous media.

Selecting a multiphysics interface under the **Chemical Species Transport>Reacting Flow in Porous Media** branch of the **Model Wizard** or **Add Physics** windows, a **Brinkman Equations** interface combined with either the **Transport of Diluted Species in Porous Media** interface or the **Transport of Concentrated Species** interfaces are added to the Model Builder.

In addition, the Multiphysics node is added, which includes the multiphysics coupling feature. The multiphysics coupling feature controls the coupling between the separate interfaces in order to facilitate easy setup of models.

In this section:

- [The Reacting Flow in Porous Media, Transport of Diluted Species Interface](#)
- [The Reacting Flow in Porous Media, Transport of Concentrated Species Interface](#)
- [The Reacting Flow, Diluted Species Coupling Feature](#)
- [The Reacting Flow Coupling Feature](#)
- [Physics Interface Features](#)

The Reacting Flow in Porous Media, Transport of Diluted Species Interface

The **Reacting Flow in Porous Media, Transport of Diluted Species** interface () is used to study the flow and chemical composition of a gas or liquid moving through the interstices of a porous medium.

It combines the **Brinkman Equations**, and **Transport of Diluted Species in Porous Media** interfaces. The **Reacting Flow, Diluted Species** multiphysics coupling feature, which is added automatically, couples the fluid flow and mass transport. A **Porous Material** node, including a **Fluid** and a **Solid** subnode, is also added to the component.

The interface can be used for stationary and time-dependent analysis in 2D, 2Daxi, and 3D.

On the constituent physics interfaces:

The **Brinkman Equations** interface computes the fluid velocity and pressure fields of single-phase flow in porous media in the laminar flow regime. A **Porous Medium** feature is active by default on the entire interface selection.

The **Transport of Diluted Species in Porous Media** interface computes the species concentration in free and porous media, assuming that the species are solutes, dissolved in a solvent of significantly higher concentration. A **Porous Medium** feature is active by default on the entire interface selection.

The Reacting Flow in Porous Media, Transport of Concentrated Species Interface

The **Reacting Flow in Porous Media, Transport of Concentrated Species** interface () is used to study the flow and chemical composition of a gas or liquid moving through the interstices of a porous medium. The fluid can consist of a mixture of species where the individual concentrations are of comparable order of magnitude.

It combines the **Brinkman Equations**, and **Transport of Concentrated Species** interfaces. The **Reacting Flow** multiphysics coupling feature, which is added automatically, couples the fluid flow and mass transport. A **Porous Material** node is also added to the component.

The interface can be used for stationary and time-dependent analysis in 2D, 2Daxi, and 3D.

On the constituent physics interfaces:

The **Brinkman Equations** interface computes the fluid velocity and pressure fields of single-phase flow in porous media in the laminar flow regime. A **Porous Medium** feature is active by default on the entire interface selection.

The **Transport of Concentrated Species in Porous Media** interface solves for an arbitrary number of mass fractions in free and porous media. In the current multiphysics interface a **Porous Medium** feature is active by default on the entire interface selection.

The Reacting Flow, Diluted Species Coupling Feature

For the settings of this feature see [The Reacting Flow, Diluted Species Coupling Feature](#) in the *Chemical Reaction Engineering Module User's Guide*.

The Reacting Flow Coupling Feature

For the settings of this feature see [The Reacting Flow Coupling Feature](#) in the *Chemical Reaction Engineering Module User's Guide*.

Physics Interface Features

Physics nodes are available from the **Physics** ribbon toolbar (Windows users), **Physics** context menu (Mac or Linux users), or right-click to access the context menu (all users).

BRINKMAN EQUATIONS

The available physics features for The Brinkman Equations interface are listed in the [Domain, Boundary, Point, and Pair Nodes for the Brinkman Equations Interface](#) section in the *CFD Module User's Guide*.

TRANSPORT OF DILUTED SPECIES

The available physics features for The Transport of Diluted Species interface are listed in the [Domain, Boundary, and Pair Nodes for the Transport of Diluted Species Interface](#) section.

TRANSPORT OF CONCENTRATED SPECIES

The available physics features for The Transport of Concentrated Species interface are listed in the [Domain, Boundary, and Pair Nodes for the Transport of Concentrated Species Interface](#) section.

The Nonisothermal Reacting Flow Multiphysics Interfaces

Nonisothermal Reacting Flow is a predefined multiphysics interface, available in the Battery Design Module, that couples fluid flow and heat transfer with species transport and reactions.

Selecting an entry in the **Chemical Species Transport>Nonisothermal Reacting Flow** branch of the **Model Wizard**, or **Add Physics** windows, the following four physics interfaces are added to the Model Builder:

- **Chemistry**
- **Transport of Concentrated Species**
- **Laminar Flow**, or a turbulent flow equivalent like **Turbulent Flow, k - ε** .
- **Heat Transfer in Fluids**

In addition, the Multiphysics node is added, which includes the multiphysics coupling feature **Reacting Flow**. The **Reacting Flow** feature predefines and controls the couplings between the separate interfaces in order to facilitate set up of models.

In this section:

- [The Nonisothermal Reacting Laminar Flow Interface](#)
- [The Nonisothermal Reacting Turbulent Flow, \$k\$ - \$\varepsilon\$ Interface](#)
- [The Nonisothermal Reacting Turbulent Flow, \$k\$ - \$\omega\$ Interface](#)
- [The Nonisothermal Reacting Turbulent Flow, SST Interface](#)
- [The Nonisothermal Reacting Turbulent Flow, Low Re \$k\$ - \$\varepsilon\$ Interface](#)
- [The Reacting Flow Coupling Feature](#)
- [Physics Interface Features](#)

The Nonisothermal Reacting Laminar Flow Interface

The **Nonisothermal Reacting Laminar Flow** () multiphysics interface is used to simulate laminar flow and heat transfer coupled to species transport in a gas or liquid moving either in a free flow or through the interstices of a porous medium.

It combines the **Chemistry**, **Transport of Concentrated Species**, **Laminar Flow**, and **Heat Transfer in Fluids** interfaces. The **Reacting Flow** multiphysics coupling, which is added

automatically, couples fluid flow, heat transfer, and mass transfer. The species transport supports both a mixture, where the concentrations are of comparable order of magnitude, and low-concentration solutes in a solvent.

The multiphysics coupling takes into account the heat of reaction in the fluid and at the surface of a porous catalyst, enthalpy diffusion, and contributing mass fluxes. In addition, the temperature dependency of the chemical properties and reactions are accounted for.

The interface can be used for stationary and time-dependent analysis in 2D, 2D axial symmetry, and 3D.

On the constituent physics interfaces:

The **Chemistry** interface defines thermodynamic properties and transport properties of the fluid. Provided that properties of each species have been defined, composition dependent mixture properties such as the heat capacity, the density, and the heat conduction are defined. The **Chemistry** interface also defines reaction rates for species involved in the chemical reactions added to the system.

The **Transport of Concentrated Species** interface solves for an arbitrary number of mass fractions. The species equations include transport by convection, diffusion and, optionally, migration in an electric field. A **Transport Properties** feature is active by default on the entire interface selection

The equations solved by the **Laminar Flow** interface are the Navier–Stokes equations for conservation of momentum and the continuity equation for conservation of mass. A **Fluid Properties** feature is active by default on the entire interface selection.

The **Heat Transfer** interface solves for conservation of energy. A **Fluid** feature is active by default on the entire interface selection.

The Nonisothermal Reacting Turbulent Flow, k - ε Interface

The **Nonisothermal Reacting Turbulent Flow, k - ε** () multiphysics interface is used to simulate flow in the turbulent regime, heat transfer, and species transport and in a gas or liquid moving either in a free flow or through the interstices of a porous medium. This interface requires a license for either the CFD Module or the Heat Transfer Module.

It combines the **Chemistry**, **Transport of Concentrated Species**, **Turbulent Flow, k - ε** , and **Heat Transfer in Fluids** interfaces. The **Reacting Flow** multiphysics coupling, which is added automatically, couples fluid flow, heat transfer and mass transfer. The species

transport supports both a mixture, where the concentrations are of comparable order of magnitude, and low-concentration solutes in a solvent.

The multiphysics coupling takes into account the heat of reaction in the fluid and at the surface of a porous catalyst, enthalpy diffusion, and contributing mass fluxes. In addition, the temperature dependency of the chemical properties and reactions are accounted for.

The interface can be used for stationary and time-dependent analysis in 2D, 2D axial symmetry, and 3D.

On the constituent physics interfaces:

The **Chemistry** interface defines thermodynamic properties and transport properties of the fluid. Provided that properties of each species have been defined, composition dependent mixture properties such as the heat capacity, the density, and the heat conduction are defined. The **Chemistry** interface also defines reaction rates for species involved in the chemical reactions added to the system.

The **Transport of Concentrated Species** interface solves for an arbitrary number of mass fractions. The species equations include transport by convection, diffusion and, optionally, migration in an electric field. Mass transfer close to walls is modeled using wall functions

The equations solved by the **Turbulent Flow, k - ϵ** interface are the Navier–Stokes equations for conservation of momentum and the continuity equation for conservation of mass. Turbulence effects are modeled using the standard two-equation k - ϵ model with realizability constraints. Flow close to walls is modeled using wall functions.

The **Heat Transfer** interface solves for conservation of energy. A **Fluid** feature is active by default on the entire interface selection. Heat transfer close to walls is modeled using wall functions.

The Nonisothermal Reacting Turbulent Flow, k - ω Interface

The **Nonisothermal Reacting Turbulent Flow, k - ω** () multiphysics interface is used to simulate flow in the turbulent regime, heat transfer, and species transport and in a gas or liquid moving either in a free flow or through the interstices of a porous medium. This interface requires a license for the CFD Module.

It combines the **Chemistry**, **Transport of Concentrated Species**, **Turbulent Flow, k - ω** , and **Heat Transfer in Fluids** interfaces. The **Reacting Flow** multiphysics coupling, which is

added automatically, couples fluid flow, heat transfer and mass transfer. The species transport supports both a mixture, where the concentrations are of comparable order of magnitude, and low-concentration solutes in a solvent.

The multiphysics coupling takes into account the heat of reaction in the fluid and at the surface of a porous catalyst, enthalpy diffusion, and contributing mass fluxes. In addition, the temperature dependency of the chemical properties and reactions are accounted for.

The interface can be used for stationary and time-dependent analysis in 2D, 2D axial symmetry, and 3D.

On the constituent physics interfaces:

The **Chemistry** interface defines thermodynamic properties and transport properties of the fluid. Provided that properties of each species have been defined, composition dependent mixture properties such as the heat capacity, the density, and the heat conduction are defined. The **Chemistry** interface also defines reaction rates for species involved in the chemical reactions added to the system.

The **Transport of Concentrated Species** interface solves for an arbitrary number of mass fractions. The species equations include transport by convection, diffusion and, optionally, migration in an electric field. Mass transfer close to walls is modeled using wall functions

The equations solved by the **Turbulent Flow, k- ω** interface are the Navier–Stokes equations for conservation of momentum and the continuity equation for conservation of mass. The fluid flow turbulence is modeled using the Wilcox revised k- ω model with realizability constraints. Flow close to walls is modeled using wall functions.

The **Heat Transfer** interface solves for conservation of energy. A **Fluid** feature is active by default on the entire interface selection. Heat transfer close to walls is modeled using wall functions.

The Nonisothermal Reacting Turbulent Flow, SST Interface

The **Nonisothermal Reacting Turbulent Flow, SST** () multiphysics interface is used to simulate flow in the turbulent regime, heat transfer, and species transport and in a gas or liquid moving either in a free flow or through the interstices of a porous medium. This interface requires a license for either the CFD Module or the Heat Transfer Module.

It combines the **Chemistry**, **Transport of Concentrated Species**, **Turbulent Flow**, **SST**, and **Heat Transfer in Fluids** interfaces. The **Reacting Flow** multiphysics coupling, which is added automatically, couples fluid flow, heat transfer and mass transfer. The species transport supports both a mixture, where the concentrations are of comparable order of magnitude, and low-concentration solutes in a solvent.

The multiphysics coupling takes into account the heat of reaction in the fluid and at the surface of a porous catalyst, enthalpy diffusion, and contributing mass fluxes. In addition, the temperature dependency of the chemical properties and reactions are accounted for.

The interface can be used for stationary and time-dependent analysis in 2D, 2D axial symmetry, and 3D.

On the constituent physics interfaces:

The **Chemistry** interface defines thermodynamic properties and transport properties of the fluid. Provided that properties of each species have been defined, composition dependent mixture properties such as the heat capacity, the density, and the heat conduction are defined. The **Chemistry** interface also defines reaction rates for species involved in the chemical reactions added to the system.

The **Transport of Concentrated Species** interface solves for an arbitrary number of mass fractions. The species equations include transport by convection, diffusion and, optionally, migration in an electric field. Mass transfer close to walls is modeled using wall functions

The equations solved by the **Turbulent Flow, SST** interface are the Navier–Stokes equations for conservation of momentum and the continuity equation for conservation of mass. The fluid flow turbulence is modeled using the SST model. The SST model is a low-Reynolds number model which means that it resolves the velocity, pressure, and concentrations all the way down to the wall. For that reason this physics interface is suited for studying mass transfer at high Schmidt numbers. The SST model depends on the distance to the closest wall, and the interface therefore includes a wall distance equation.

The **Heat Transfer** interface solves for conservation of energy. A **Fluid** feature is active by default on the entire interface selection. Heat transfer close to walls is modeled using wall functions.

The Nonisothermal Reacting Turbulent Flow, Low Re k-ε Interface

The **Nonisothermal Reacting Turbulent Flow, Low Re k-ε** () multiphysics interface is used to simulate flow in the turbulent regime, heat transfer, and species transport and in a gas or liquid moving either in a free flow or through the interstices of a porous medium. This interface requires a license for either the CFD Module or the Heat Transfer Module.

It combines the **Chemistry, Transport of Concentrated Species, Turbulent Flow, Low Re k-ε**, and **Heat Transfer in Fluids** interfaces. The **Reacting Flow** multiphysics coupling, which is added automatically, couples fluid flow, heat transfer and mass transfer. The species transport supports both a mixture, where the concentrations are of comparable order of magnitude, and low-concentration solutes in a solvent.

The multiphysics coupling takes into account the heat of reaction in the fluid and at the surface of a porous catalyst, enthalpy diffusion, and contributing mass fluxes. In addition, the temperature dependency of the chemical properties and reactions are accounted for.

The interface can be used for stationary and time-dependent analysis in 2D, 2D axial symmetry, and 3D.

On the constituent physics interfaces:

The **Chemistry** interface defines thermodynamic properties and transport properties of the fluid. Provided that properties of each species have been defined, composition dependent mixture properties such as the heat capacity, the density, and the heat conduction are defined. The **Chemistry** interface also defines reaction rates for species involved in the chemical reactions added to the system.

The **Transport of Concentrated Species** interface solves for an arbitrary number of mass fractions. The species equations include transport by convection, diffusion and, optionally, migration in an electric field. Mass transfer close to walls is modeled using wall functions

The equations solved by the **Turbulent Flow, Low Re k-ε** interface are the Navier–Stokes equations for conservation of momentum and the continuity equation for conservation of mass. The fluid flow turbulence is modeled using the AKN low-Reynolds number k-ε model. The low-Reynolds number model resolves the velocity, pressure, and concentrations all the way down to the wall. For that reason this physics interface is suited for studying mass transfer at high Schmidt numbers. The

AKN model depends on the distance to the closest wall, and the interface therefore includes a wall distance equation.

The **Heat Transfer** interface solves for conservation of energy. A **Fluid** feature is active by default on the entire interface selection. Heat transfer close to walls is modeled using wall functions.

The Reacting Flow Coupling Feature

For the settings of this feature see [The Reacting Flow Coupling Feature](#).

Physics Interface Features

Physics nodes are available from the **Physics** ribbon toolbar (Windows users), **Physics** context menu (Mac or Linux users), or right-click to access the context menu (all users).



In general, to add a node, go to the **Physics** toolbar, no matter what operating system you are using.

CHEMISTRY

The available physics features for the Chemistry interface are listed in the section [Feature Nodes Available for the Chemistry Interface](#).

LAMINAR FLOW

The available physics features for The Laminar Flow interface are listed in the section [Domain, Boundary, Pair, and Point Nodes for Single-Phase Flow](#) in the *CFD Module User's Guide*.

TURBULENT FLOW

The available physics features for a single-phase flow interface using a turbulence model, for example the Turbulent Flow, k- ϵ interface, is listed in the section [Domain, Boundary, Pair, and Point Nodes for Single-Phase Flow](#) in the *CFD Module User's Guide*.

TRANSPORT OF CONCENTRATED SPECIES

The available physics features for the Transport of Concentrated Species interface are listed in the section [Domain, Boundary, and Pair Nodes for the Transport of Concentrated Species Interface](#).

HEAT TRANSFER

The available physics features for the Heat Transfer interface are listed in the section [The Heat Transfer Features](#) in the *COMSOL Multiphysics Reference Manual*.

Theory for the Transport of Diluted Species Interface

The [Transport of Diluted Species Interface](#) provides a predefined modeling environment for studying the evolution of chemical species transported by diffusion and convection as well as migration due to an electric field. The physics interface assumes that all species present are dilute; that is, that their concentration is low compared to a solvent fluid or solid. As a rule of thumb, a mixture containing several species can be considered dilute when the concentration of the solvent is more than 90 mol%. Due to the dilution, mixture properties such as density and viscosity can be assumed to correspond to those of the solvent.

When studying mixtures that are not dilute, the mixture and transport properties depend on the composition, and a different physics interface is recommended. See [The Transport of Concentrated Species Interface](#) in the *Chemical Reaction Engineering Module User's Guide* for more information.

Fick's law governs the diffusion of the solutes, dilute mixtures, or solutions, while the phenomenon of ionic migration is sometimes referred to as *electrokinetic flow*. The Transport of Diluted Species interface supports the simulations of chemical species transport by convection, migration, and diffusion in 1D, 2D, and 3D as well as for axisymmetric components in 1D and 2D.

In this section:

- [Adding Transport Through Migration](#)
- [Convective Term Formulation](#)
- [Crosswind Diffusion](#)
- [Danckwerts Inflow Boundary Condition](#)
- [Equilibrium Reaction Theory](#)
- [Mass Balance Equation](#)
- [Mass Sources for Species Transport](#)
- [Solving a Diffusion Equation Only](#)
- [Supporting Electrolytes](#)
- [References](#)

Note: Some features explained in this section require certain add-on modules. For details see <https://www.comsol.com/products/specifications/>

The section also includes the theory for [The Transport of Diluted Species in Porous Media Interface](#):

- [Adsorption](#)
- [Convection in Porous Media](#)
- [Diffusion in Porous Media](#)
- [Dispersion](#)
- [Mass Balance Equation for Transport of Diluted Species in Porous Media](#)
- [Mass Transport in Fractures](#)
- [Reactions](#)

Mass Balance Equation

The default node attributed to the Transport of Diluted Species interface models chemical species transport through diffusion and convection and solves the mass conservation equation for one or more chemical species i :

$$\frac{\partial c_i}{\partial t} + \nabla \cdot \mathbf{J}_i + \mathbf{u} \cdot \nabla c_i = R_i \quad (6-17)$$

[Equation 6-17](#) in its form above includes the transport mechanisms diffusion and convection. If *Migration in Electric Field* is activated (only available in some add-on products), the migration mechanism will be added to the equation as well. See more details in the section [Adding Transport Through Migration](#).

- c_i is the concentration of the species (SI unit: mol/m³)
- D_i denotes the diffusion coefficient (SI unit: m²/s)
- R_i is a reaction rate expression for the species (SI unit: mol/(m³·s))
- \mathbf{u} is the mass averaged velocity vector (SI unit: m/s)
- \mathbf{J}_i is the mass flux diffusive flux vector (SI unit: mol/(m²·s))

The mass flux relative to the mass averaged velocity, \mathbf{J}_i (SI unit: mol/(m²·s)), is associated with the mass balance equation above and used in boundary conditions and flux computations. The Transport of Diluted Species interface always includes mass transport due to molecular diffusion. In this case the mass flux \mathbf{J}_i defines the diffusive flux vector

$$\mathbf{J}_i = -D\nabla c_i \quad (6-18)$$

An input field for the diffusion coefficient is available.

When *Migration in Electric Fields* is activated, the migration term is also added to the diffusive flux vector as shown in the section [Adding Transport Through Migration](#).

The third term on the left side of [Equation 6-17](#) describes the convective transport due to a velocity field \mathbf{u} . This field can be expressed analytically or obtained from coupling the physics interface to one that solves for fluid flow, such as *Laminar Flow*. Note that all fluid flow interfaces solve for the mass averaged velocity.

On the right-hand side of the mass balance equation ([Equation 6-17](#)), R_i represents a source or sink term, typically due to a chemical reaction or desorption on a porous matrix. To specify R_i , another node must be added to the Transport of Diluted Species interface — the **Reaction** node for example, which includes an input field for specifying a reaction expression using the variable names of all participating species.

Equilibrium Reaction Theory

The feature Equilibrium Reaction is described in this section. A chemical equilibrium reaction system is defined by the stoichiometry of the reaction and the relation between the chemical activities of the chemical species participating in the reaction (the equilibrium condition).

The kinetics of the reaction is so fast that the equilibrium condition is fulfilled at all times in all space coordinates.

The equilibrium condition is commonly based on the stoichiometric coefficients, ν_i (dimensionless), of the reaction; the species activities of the reacting species a_i (dimensionless); and an equilibrium constant, K_{eq} (1) according to:

$$K_{\text{eq}} = \frac{\prod_{i \in \text{products}} a_i^{\nu_i}}{\prod_{i \in \text{reactants}} a_i^{-\nu_i}}$$

where the species activities are defined as

$$a_i = \gamma_{c,i} \frac{c_i}{c_{a0}}$$

where c_{a0} (SI unit: mol/m³) is the standard molarity, and $\gamma_{c,i}$ (dimensionless) an activity coefficient.

Defining the stoichiometric coefficients positive for products and negative for reactants, the above equilibrium condition can also be written:

$$K_{\text{eq}} = \prod_i a_i^{v_i}$$

The **Equilibrium Reaction** node solves for a reaction rate so that the equilibrium condition is always fulfilled in the domain. It is available for the Chemical Reaction Engineering Module; Battery Design Module; Corrosion Module; Electrochemistry Module; Electrodeposition Module; and Fuel Cell & Electrolyzer Module.



$\gamma_{e,i}$ is set to unity when the Equilibrium constant is selected in the Settings window. For nonunity activity coefficients, a user defined equilibrium condition can be used.

EQUILIBRIUM REACTIONS AND INFLOW BOUNDARY CONDITIONS

Contradictory constraints arise if the boundary conditions for concentrations or activities are set so that the domain equilibrium condition is not fulfilled. Special treatment is therefore needed at Inflow boundaries, where the concentrations are set for all species in the mass transport interfaces.

One way of avoiding competing constraints on an inflow boundary is to add an additional reaction coordinate degree of freedom, solved for to create a set of modified inflow concentrations that fulfill the domain equilibrium condition. The reaction coordinate gives rise to a concentration shift, which is the offset to the inflow concentrations provided by the user. The shift for each species obeys the stoichiometry of the reaction and the equilibrium expression. The modified inflow concentrations are then used in the boundary conditions for the domain mass transport equations. The resulting modified inflow concentrations can be seen as the stationary solution for a batch reactor with the user inflow concentrations as initial concentrations. In addition, the domain reaction rate degree of freedom of the equilibrium reaction is constrained to zero on all Inflow boundaries.

EQUILIBRIUM REACTIONS AND CONCENTRATION BOUNDARY CONDITIONS

No special treatment is made with regards to input concentration values of the Concentration boundary node. Using this feature, you can explicitly set one or a set of concentrations, and the equilibrium condition acts on the rest of the concentrations.

However, there is no solution to the problem if more concentrations than the number of species minus the number of equilibrium reactions are set using this feature.

EQUILIBRIUM REACTIONS AND TIME-DEPENDENT SIMULATIONS

Spurious oscillations may occur in a time-dependent problem if the initial conditions do not fulfill the equilibrium condition. Since equilibrium reactions are assumed to be infinitely fast, the solution is to initialize the problem using an additional study step, solving for a stationary problem with all nonequilibrium reaction rates set to zero. Manual scaling of the reaction rate dependent variables is needed in this study step.

Convective Term Formulation

The default node attributed to [The Transport of Diluted Species Interface](#) assumes chemical species transport through diffusion and convection (depending on the modules licensed, a check box to activate migration is available) and implements the mass balance equation in [Equation 6-17](#).

There are two ways to present a mass balance where chemical species transport occurs through diffusion and convection. These are the nonconservative and conservative formulations of the convective term:

$$\text{nonconservative: } \frac{\partial c}{\partial t} + \mathbf{u} \cdot \nabla c = \nabla \cdot \mathbf{J}_i + R \quad (6-19)$$

$$\text{conservative: } \frac{\partial c}{\partial t} + \nabla \cdot (c\mathbf{u}) = \nabla \cdot \mathbf{J}_i + R \quad (6-20)$$

and each is treated slightly differently by the solver algorithms. In these equations \mathbf{J}_i (SI unit: $\text{mol}/(\text{m}^2 \cdot \text{s})$) is the diffusive flux vector, R (SI unit: $\text{mol}/(\text{m}^3 \cdot \text{s})$) is a production or consumption rate expression, and \mathbf{u} (SI unit: m/s) is the solvent velocity field. The diffusion process can be anisotropic, in which case D is a tensor.

If the conservative formulation is expanded using the chain rule, then one of the terms from the convection part, $c\nabla \cdot \mathbf{u}$, would equal zero for an incompressible fluid and would result in the nonconservative formulation above. This is in fact the default formulation in this physics interface. To switch between the two formulations, click the **Show** button () and select **Advanced Physics Options**.

Solving a Diffusion Equation Only

Remove the convection term from [Equation 6-19](#) and [Equation 6-20](#) by clearing the Convection check box in the Transport Mechanisms section for [The Transport of Diluted Species Interface](#). The equation then becomes

$$\frac{\partial c}{\partial t} = \nabla \cdot \mathbf{J}_i + R$$

Mass Sources for Species Transport

Note: The features below are only available in a limited set of add-on products. For a detailed overview of which features are available in each product, visit <https://www.comsol.com/products/specifications/>

There are two types of mass sources in the Transport of Diluted Species interface: point sources and line sources.

POINT SOURCE

A point source is theoretically formed by assuming a mass injection/ejection, Q_c (SI unit: mol/(m³·s)), in a small volume δV and then letting the size of the volume tend to zero while keeping the total mass flux constant. Given a point source strength, $\dot{q}_{p,c}$ (SI unit: mol/s), this can be expressed as

$$\lim_{\delta V \rightarrow 0} \int_{\delta V} Q_c = \dot{q}_{p,c} \quad (6-21)$$

An alternative way to form a point source is to assume that mass is injected/extracted through the surface of a small object. Letting the object surface area tend to zero while keeping the mass flux constant results in the same point source. For this alternative approach, effects resulting from the physical object's volume need to be neglected.

The weak contribution

$$\dot{q}_{p,c} \text{test}(c)$$

is added at a point in the geometry. As can be seen from [Equation 6-21](#), Q_c must tend to plus or minus infinity as δV tends to zero. This means that in theory the concentration also tends to plus or minus infinity.

Observe that “point” refers to the physical representation of the source. A point source can therefore only be added to points in 3D components and to points on the symmetry axis in 2D axisymmetry components. Other geometrical points in 2D components represent physical lines.

The finite element representation of [Equation 6-21](#) corresponds to a finite concentration at a point with the effect of the point source spread out over a region around the point. The size of the region depends on the mesh and on the strength of the source. A finer mesh gives a smaller affected region but also a more extreme concentration value. It is important not to mesh too finely around a point source since this can result in unphysical concentration values. It can also have a negative effect on the condition number for the equation system.

LINE SOURCE

A line source can theoretically be formed by assuming a source of strength $Q_{1,c}$ (SI unit: mol/(m³·s)), located within a tube with cross section δS and then letting δS tend to zero while keeping the total mass flux per unit length constant. Given a line source strength, $\dot{q}_{1,c}$ (SI unit: mol/(m·s)), this can be expressed as

$$\lim_{\delta S \rightarrow 0} \int_{\delta S} Q_{1,c} = q_{1,c} \quad (6-22)$$

As in the point source case, an alternative approach is to assume that mass is injected/extracted through the surface of a small object. This results in the same mass source, but requires that effects resulting from the physical object’s volume are neglected.

The weak contribution

$$q_{1,c} \text{test}(c)$$

is added on lines in 3D or at points in 2D (which represent cut-through views of lines). Line sources can also be added on the axisymmetry line in 2D axisymmetry components. It cannot, however, be added on geometrical lines in 2D since those represent physical planes.

As with a point source, it is important not to mesh too finely around the line source.



For feature node information, see [Line Mass Source](#) and [Point Mass Source](#).

For the Reacting Flow in Porous Media, Diluted Species interface, which is available with the CFD Module, Chemical Reaction Engineering Module, or Battery Design Module, these shared physics nodes are renamed as follows:



- The **Line Mass Source** node is available as two nodes, one for the fluid flow (**Fluid Line Source**) and one for the species (**Species Line Source**).
- The **Point Mass Source** node is available as two nodes, one for the fluid flow (**Fluid Point Source**) and one for the species (**Species Point Source**).

Adding Transport Through Migration

Note: Migration is only available in a limited set of add-on products. For a detailed overview of which features are available in each product, visit <https://www.comsol.com/products/specifications/>

In addition to transport due to convection and diffusion, the Transport of Diluted Species interface supports ionic species transport by *migration*. This is done by selecting the Migration in Electric Field check box under the Transport Mechanisms section for the physics interface. The mass balance then becomes:

$$\frac{\partial c_i}{\partial t} + \nabla \cdot (-D_i \nabla c_i - z_i u_{m,i} F c_i \nabla V + c_i \mathbf{u}) = R_i \quad (6-23)$$

where

- c_i (SI unit: mol/m³) denotes the concentration of species i
- D_i (SI unit: m²/s) is the diffusion coefficient of species i
- \mathbf{u} (SI unit: m/s) is the fluid velocity
- F (SI unit: A·s/mol) refers to Faraday's constant
- V (SI unit: V) denotes the electric potential
- z_i (dimensionless) is the charge number of the ionic species, and
- $u_{m,i}$ (SI unit: mol·s/kg) is its ionic mobility

In this case the diffusive flux vector is

$$\mathbf{J}_i = -D_i \nabla c_i - z_i u_{m,i} F c_i \nabla V$$

The velocity, \mathbf{u} , can be a computed fluid velocity field from a Fluid Flow interface or a specified function of the spatial variables x , y , and z . The potential can be provided by an expression or by coupling the system of equations to a current balance, such as the Electrostatics interface. Sometimes it is assumed to be a supporting electrolyte present, which simplifies the transport equations. In that case, the modeled charged species concentration is very low compared to other ions dissolved in the solution. Thus, the species concentration does not influence the solution's conductivity and the net charge within the fluid.

The Nernst–Einstein relation can in many cases be used for relating the species mobility to the species diffusivity according to

$$u_{m,i} = \frac{D_i}{RT}$$

where R (SI unit: J/(mol·K)) is the molar gas constant and T (SI unit: K) is the temperature.

Note: In the *Nernst–Planck Equations* interface, the ionic species contribute to the charge transfer in the solution. It includes an *electroneutrality condition* and also computes the electric potential field in the electrolyte. For more information, see [Theory for the Nernst–Planck Equations Interface](#). This interface is included in the Chemical Reaction Engineering Module.

Supporting Electrolytes

In *electrolyte* solutions, a salt can be added to provide a high electrolyte conductivity and decrease the ohmic losses in a cell. These solutions are often called *supporting electrolytes*, buffer solutions, or carrier electrolytes. The added species, a negative and a positive ion pair, predominates over all other species. Therefore, the supporting electrolyte species can be assumed to dominate the current transport in the solution. In addition, the predominant supporting ions are usually selected so that they do not react at the electrode surfaces since the high conductivity should be kept through the process, that is, they should not be electroactive species. This also means that the concentration gradients of the predominant species in a supporting electrolyte are usually negligible.

Modeling and solving for a supporting electrolyte in the *Electrostatics* or *Secondary Current Distribution* interfaces will give a potential distribution that drives the migration in the Transport of Diluted Species Interface.

The current density vector is proportional to the sum of all species fluxes as expressed by Faraday's law:

$$\mathbf{i} = F \sum_i z_i \mathbf{N}_i$$

The electroneutrality condition ensures that there is always a zero net charge at any position in a dilute solution. Intuitively, this means that it is impossible to create a current by manually pumping positive ions in one direction and negative ions in the other. Therefore, the convective term is canceled out to yield the following expression for the electrolyte current density, where j denotes the supporting species:

$$\mathbf{i} = F \sum_j -z_j^2 u_{m,j} F c_j \nabla \phi \quad (6-24)$$

Equation 6-24 is simply Ohm's law for ionic current transport and can be simplified to

$$\mathbf{i} = -\kappa \nabla \phi \quad (6-25)$$

where κ is the conductivity of the supporting electrolyte. A current balance gives the current and potential density in the cell

$$\nabla \cdot \mathbf{i} = 0$$

which, in combination with Equation 6-25, yields:

$$\nabla \cdot (-\kappa \nabla \phi) = 0 \quad (6-26)$$

Equation 6-26 can be easily solved using the Electrostatics or Secondary Current Distribution interface and, when coupled to the Transport in Diluted Species interface, the potential distribution shows up in the migration term.

Crosswind Diffusion

Transport of diluted species applications can often result in models with a very high cell Péclet number — that is, systems where convection or migration dominates over diffusion. Streamline diffusion and crosswind diffusion are of paramount importance to obtain physically reasonable results. The Transport of Diluted Species interface

provides two crosswind diffusion options using different formulations. Observe that crosswind diffusion makes the equation system nonlinear even if the transport equation is linear.

DO CARMO AND GALEÃO

This is the formulation described in [Numerical Stabilization](#) in the *COMSOL Multiphysics Reference Manual*. The method reduces over- and undershoots to a minimum, even for anisotropic meshes.

In some cases, the resulting nonlinear equation system can be difficult to converge. This can happen when the cell Péclet number is very high and the model contains many thin layers, such as contact discontinuities. You then have three options:

- Refine the mesh, especially in regions with thin layers.
- Use a nonlinear solver with a constant damping factor less than one.
- Switch to the Codina crosswind formulation.

CODINA

The Codina formulation is described in [Ref. 1](#). It adds diffusion strictly in the direction orthogonal to the streamline direction. Compared to the do Carmo and Galeão formulation, the Codina formulation adds less diffusion but is not as efficient at reducing over- and undershoots. It also does not work as well for anisotropic meshes. The advantage is that the resulting nonlinear system is easier to converge and that underresolved gradients are less smeared out.

Danckwerts Inflow Boundary Condition

Constraining the composition to fixed values at an inlet to a reactor may sometimes result in issues with unreasonably high reaction rates or singularities at the inlet boundary. These problems may many times be mitigated by using a flux boundary condition instead, based on the upstream concentrations and the fluid velocity at the boundary. In chemical engineering, this type of flux boundary condition is also known as a Danckwerts condition.

Use the Danckwerts condition to specify inlet conditions for domains where high reaction rates are anticipated in the vicinity to the inlet ([Ref. 2](#)).

Given an upstream concentration $c_{i,0}$, the Danckwerts inflow boundary condition prescribed the total flux as

$$\mathbf{n} \cdot (\mathbf{J}_i + \mathbf{u}c_i) = \mathbf{n} \cdot (\mathbf{u}c_{i,0}) \quad (6-27)$$

Mass Balance Equation for Transport of Diluted Species in Porous Media

VARIABLY SATURATED POROUS MEDIA

The following equations for the molar concentrations, c_i , describe the transport of solutes in a variably saturated porous medium for the most general case, when the pore space is primarily filled with liquid but also contain pockets or immobile gas:

$$\begin{aligned} \frac{\partial}{\partial t}(\theta_l c_i) + \frac{\partial}{\partial t}(\rho c_{P,i}) + \frac{\partial}{\partial t}(\theta_g c_{G,i}) + \mathbf{u} \cdot \nabla c_i = \\ \nabla \cdot [(D_{D,i} + D_{e,i})\nabla c_i] + R_i + S_i \end{aligned} \quad (6-28)$$

On the left-hand side of [Equation 6-28](#), the first three terms correspond to the accumulation of species within the liquid, solid, and gas phases, while the last term describes the convection due to the velocity field \mathbf{u} (SI unit: m/s).

In [Equation 6-28](#) c_i denotes the concentration of species i in the liquid (SI unit: mol/m³), $c_{P,i}$ the amount adsorbed to solid particles (moles per unit dry weight of the solid), and $c_{G,i}$ the concentration of species i in the gas phase.

The equation balances the mass transport throughout the porous medium using the porosity ε_p , the liquid volume fraction θ_l ; the dry bulk density, $\rho = (1 - \varepsilon_s)\rho_s$, and the solid phase density ρ_s .

For saturated porous media, the liquid volume fraction θ_l is equal to the porosity ε_p , but for unsaturated porous media, they are related by the saturation s as $\theta_l = \varepsilon_p s$. The resulting gas volume fraction in the case of an unsaturated porous medium is

$$\theta_g = \varepsilon_p - \theta_l = (1 - s)\varepsilon_p$$

On the right-hand side of [Equation 6-28](#), the first term introduces the spreading of species due to mechanical mixing resulting from the porous media (dispersion), as well as from diffusion and volatilization to the gas phase. The dispersion tensor is denoted D_D (SI unit: m²/s) and the effective diffusion by D_e (SI unit: m²/s).

The last two terms on the right-hand side of [Equation 6-28](#) describe production or consumption of the species; R_i is a reaction rate expression which can account for reactions in the liquid, solid, or gas phase, and S_i is an arbitrary source term, for example due to a fluid flow source or sink.

Adsorption

The time evolution of the adsorption, the solute transport to or from the solid phase, is defined by assuming that the amount of solute adsorbed to the solid, $c_{P,i}$, is a function of the concentration in the fluid c_i . This implies that the solute concentration in the liquid and solid phase are in instant equilibrium. The adsorption term can be expanded to give

$$\frac{\partial}{\partial t}(\rho c_{P,i}) = \rho \frac{\partial c_{P,i}}{\partial c_i} \frac{\partial c_i}{\partial t} - c_{P,i} \rho_s \frac{\partial \varepsilon_p}{\partial t} = \rho \bar{K}_{P,i} \frac{\partial c_i}{\partial t} - c_{P,i} \rho_s \frac{\partial \varepsilon_p}{\partial t} \quad (6-29)$$

where $\bar{K}_{P,i} = \partial c_{P,i} / \partial c_i$ is the adsorption isotherm.

Volatilization

Volatilization is the process where a solute species in the liquid is transported to the gas phase due to vaporization. Assuming that the amount of solute in the gas phase, $c_{G,i}$, is a linear function of the liquid phase concentration, the volatilization term is defined as

$$\frac{\partial}{\partial t} \theta_g c_{G,i} = \theta_g \frac{\partial c_{G,i}}{\partial c_i} \frac{\partial c_i}{\partial t} + k_{G,i} c_i \frac{\partial \theta_g}{\partial t} = \theta_g k_{G,i} \frac{\partial c_i}{\partial t} + k_{G,i} c_i \frac{\partial \theta_g}{\partial t} \quad (6-30)$$

where $k_{G,i} = \partial c_{G,i} / \partial c_i$ is the linear volatilization.

SATURATED POROUS MEDIA

In the case of transport in a saturated porous medium, $\theta_l = \varepsilon_p$, and the governing equations are

$$\frac{\partial}{\partial t}(\varepsilon_p c_i) + \frac{\partial}{\partial t}(\rho c_{P,i}) + \mathbf{u} \cdot \nabla c_i = \nabla \cdot [(D_{D,i} + D_{e,i}) \nabla c_i] + R_i + S_i \quad (6-31)$$

Convection in Porous Media

Convection (also called advection) describes the movement of a species, such as a pollutant, with the bulk fluid velocity. The velocity field \mathbf{u} corresponds to a superficial volume average over a unit volume of the porous medium, including both pores and matrix. This velocity is sometimes called *Darcy velocity*, and defined as volume flow

rates per unit cross section of the medium. This definition makes the velocity field continuous across the boundaries between porous regions and regions with free flow.



The velocity field to be used in the Model Inputs section on the physics interface can, for example, be prescribed using the velocity field from a Darcy's Law or a Brinkman Equations interface.

The average linear fluid velocities \mathbf{u}_a , provides an estimate of the fluid velocity within the pores:

$$\mathbf{u}_a = \frac{\mathbf{u}}{\varepsilon_p} \quad \text{Saturated}$$

$$\mathbf{u}_a = \frac{\mathbf{u}}{\theta_l} \quad \text{Unsaturated}$$

where ε_p is the porosity and $\theta_l = s\varepsilon_p$ the liquid volume fraction, and s the saturation, a dimensionless number between 0 and 1.

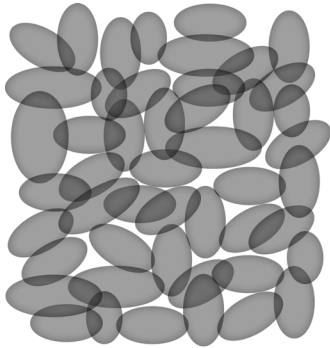

Figure 6-4: A block of a porous medium consisting of solids and the pore space between the solid grains. The average linear velocity describes how fast the fluid moves within the pores. The Darcy velocity attributes this flow over the entire fluid-solid face.

CONVECTIVE TERM FORMULATION

The Transport of Diluted Species in Porous Media interface includes two formulations of the convective term. The conservative formulation of the species equations in [Equation 6-28](#) is written as:

$$\frac{\partial}{\partial t}(\theta_l c_i) + \frac{\partial}{\partial t}(\rho c_{p,i}) + \frac{\partial}{\partial t}(\theta_g c_{g,i}) + \nabla \cdot \mathbf{u} c_i = \nabla \cdot [(D_{D,i} + D_{e,i}) \nabla c_i] + R_i + S_i \quad (6-32)$$

If the conservative formulation is expanded using the chain rule, then one of the terms from the convection part, $c_i \nabla \cdot \mathbf{u}$, would equal zero for an incompressible fluid and would result in the nonconservative formulation described in Equation 6-28.

When using the nonconservative formulation, which is the default, the fluid is assumed incompressible and divergence free: $\nabla \cdot \mathbf{u} = 0$. The nonconservative formulation improves the stability of systems coupled to a momentum equation (fluid flow equation).



To switch between the two formulations, click the **Show** button () and select **Advanced Physics Options**. In the section **Advanced Settings** select either **Nonconservative form** (the default) or **Conservative form**. The conservative formulation should be used for compressible flow.

Diffusion in Porous Media

The effective diffusion in porous media, D_e , depends on the structure of the porous material and the phases involved. Dependent on whether the transport of diluted species occurs in free flow or in saturated or unsaturated porous media, the effective diffusivity is defined as:

$$\begin{aligned} D_e &= D_F && \text{Free Flow} \\ D_e &= \frac{\epsilon_p}{\tau_L} D_L && \text{Saturated Porous Media} \\ D_e &= \frac{\theta_l}{\tau_L} D_L && \text{Unsaturated Porous Media} \\ D_e &= \frac{\theta_l}{\tau_L} D_L + \frac{\theta_g}{\tau_G} k_G D_G && \text{Unsaturated with Volatilization} \end{aligned}$$

Here D_F , D_L , and D_G are the single-phase diffusion coefficients for the species diluted in a fluid, a pure liquid, and a gas phase, respectively (SI unit: m^2/s), and τ_F , τ_L , and τ_G are the corresponding tortuosity factors (dimensionless).

The tortuosity factor accounts for the reduced diffusivity due to the fact that the solid grains impede Brownian motion. The interface provides predefined expressions to

compute the tortuosity factors in partially saturated porous media according to the Millington and Quirk model (Ref. 3):

$$\tau_L = \theta_l^{-7/3} \varepsilon_p^2, \tau_G = \theta_g^{-7/3} \varepsilon_p^2$$

and Bruggeman model

$$\tau_L = \theta_l^{-5/2} \varepsilon_p^2, \tau_G = \theta_g^{-5/2} \varepsilon_p^2$$

For saturated porous media $\theta_l = \varepsilon_p$. The fluid tortuosity for the Millington and Quirk model is

$$\tau_L = \varepsilon_p^{-1/3}$$

and for the Bruggeman model the tortuosity is defined as

$$\tau_L = \varepsilon_p^{-1/2}$$

User defined expressions for the tortuosity factor can also be applied.

Dispersion

The contribution of dispersion to the mixing of species typically overshadows the contribution from molecular diffusion, except when the fluid velocity is very low.

The spreading of mass, as a fluid travel through a porous medium is caused by several contributing effects. Local variations in fluid velocity lead to mechanical mixing referred to as dispersion occurs because the fluid in the pore space flows around solid particles, so the velocity field varies within pore channels. The spreading in the direction parallel to the flow, or *longitudinal dispersivity*, typically exceeds the *transverse dispersivity* from up to an order of magnitude. Being driven by the concentration gradient alone, molecular diffusion rate is low relative to the mechanical dispersion, except at very low fluid velocities.

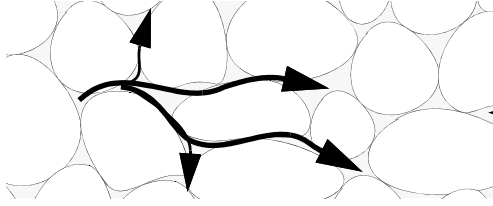

Figure 6-5: Spreading of fluid around solid particles in a porous medium.

The dispersion is controlled through the dispersion tensor D_D . The tensor components can either be given by user-defined values or expressions or derived from the directional dispersivities.

Using the longitudinal and transverse dispersivities in 2D, the dispersivity tensor components are (Ref. 5):

$$D_{Dii} = \alpha_L \frac{u_i^2}{|\mathbf{u}|} + \alpha_T \frac{u_j^2}{|\mathbf{u}|}$$

$$D_{Dij} = D_{Dji} = (\alpha_L - \alpha_T) \frac{u_i u_j}{|\mathbf{u}|}$$

In these equations, D_{Dii} (SI unit: m^2/s) are the principal components of the dispersivity tensor, and D_{Dji} and D_{Dij} are the cross terms. The parameters α_L and α_T (SI unit: m) specify the longitudinal and transverse dispersivities; and u_i (SI unit: m/s) stands for the velocity field components.

In order to facilitate modeling of stratified porous media in 3D, the tensor formulation by Burnett and Frind (Ref. 4) can be used. Consider a transverse isotropic media, where the strata are piled up in the z direction, the dispersivity tensor components are:

$$\begin{aligned}
D_{Lxx} &= \alpha_1 \frac{u^2}{|\mathbf{u}|} + \alpha_2 \frac{v^2}{|\mathbf{u}|} + \alpha_3 \frac{w^2}{|\mathbf{u}|} \\
D_{Lyy} &= \alpha_1 \frac{v^2}{|\mathbf{u}|} + \alpha_2 \frac{u^2}{|\mathbf{u}|} + \alpha_3 \frac{w^2}{|\mathbf{u}|} \\
D_{Lzz} &= \alpha_1 \frac{w^2}{|\mathbf{u}|} + \alpha_2 \frac{u^2}{|\mathbf{u}|} + \alpha_3 \frac{v^2}{|\mathbf{u}|} \\
D_{Lxy} &= D_{Lyx} = (\alpha_1 - \alpha_2) \frac{uv}{|\mathbf{u}|} \\
D_{Lxz} &= D_{Lzx} = (\alpha_1 - \alpha_3) \frac{uw}{|\mathbf{u}|} \\
D_{Lyz} &= D_{Lzy} = (\alpha_1 - \alpha_3) \frac{vw}{|\mathbf{u}|}
\end{aligned} \tag{6-33}$$

In Equation 6-33 the fluid velocities u , v , and w correspond to the components of the velocity field \mathbf{u} in the x , y , and z directions, respectively, and α_1 (SI unit: m) is the longitudinal dispersivity. If z is the vertical axis, α_2 and α_3 are the dispersivities in the transverse horizontal and transverse vertical directions, respectively (SI unit: m). Setting $\alpha_2 = \alpha_3$ gives the expressions for isotropic media shown in Bear (Ref. 5 and Ref. 6).

Adsorption

As species travel through a porous medium they typically attach to (adsorb), and detach (desorb) from the solid phase, which slows chemical transport through the porous medium. Adsorption and desorption respectively reduces or increases species concentrations in the fluid. The adsorption properties vary between chemicals, so a plume containing multiple species can separate into components (Ref. 7). The Adsorption feature includes four predefined and one user defined relationships to predict the solid concentrations, c_{pi} from the concentration in the liquid phase, c_i :

$$\begin{aligned}
c_p &= c_{p\max} \frac{K_L c}{1 + K_L c} && \text{Langmuir} \\
c_p &= K_F \left(\frac{c}{c_{\text{ref}}} \right)^N && \text{Freundlich} \\
c_p &= c_{p\max} \frac{b_T c}{(1 + (b_T c)^{N_T})^{1/N_T}} && \text{Toth} \\
c_p &= \frac{K_B c_0 c}{(c_S - c) \left(1 + (K_B - 1) \frac{c}{c_S} \right)} && \text{BET}
\end{aligned} \tag{6-34}$$

The above equations contains the following parameters:

- Freundlich (Ref. 8)
 - Freundlich constant K_F (SI unit: mol/kg), Freundlich exponent N_F (dimensionless), and reference concentration c_{ref} (SI unit: mol/m³).
- Langmuir (Ref. 9)
 - Langmuir constant K_L (SI unit: m³/mol), and adsorption maximum $c_{p\max}$ (SI unit: mol/kg).
- Toth (Ref. 10)
 - Toth constant b_T (SI unit: m³/mol), Toth exponent N_T (dimensionless), and adsorption maximum $c_{p\max}$ (SI unit: mol/kg).
- BET (Brunauer–Emmett–Teller, Ref. 11)
 - BET constant K_B (dimensionless), the monolayer adsorption capacity c_0 (SI unit: mol/kg) and the saturation concentration, c_S (SI unit: mol/m³).

These predefined expressions are adsorption isotherms that describe the amount of species sorbed to the solid. Applying the isotherms, as defined in the [Adsorption](#) section above, assumes that adsorption is at equilibrium locally. This implies that the species phase transfer, between the fluid and the solid phase (within the porous medium), is much faster than the transport within the fluid phase.

Using a [Species Source](#) feature, arbitrary expressions can be entered to define, for example, nonequilibrium and temperature-dependent adsorption laws, in the manner of Fetter (Ref. 12), or Bear and Verruijt (Ref. 13).

The retardation factor, \mathbf{RF} , describes how adsorption slows the solute velocity, \mathbf{u}_c , relative to the average linear velocity of the fluid, \mathbf{u}_a , as in

$$RF = 1 + \frac{\rho_b}{\theta} \frac{\partial c_p}{\partial c} = \frac{\mathbf{u}_a}{\mathbf{u}_c}$$

If the contaminant moves at the average linear velocity of the fluid for $RF = 1$. For $RF > 1$, the contaminant velocity is lower than the fluid velocity owing to residence time on solids.

Reactions

Chemical reactions of all types influence species transport in porous media. Examples include biodegradation, radioactive decay, transformation to tracked products, temperature- and pressure-dependent functions, exothermic reactions, and endothermic reactions. The reactions represent change in species concentration per unit volume porous medium per time. Reaction terms are used on the right-hand side of the governing equation to represent these processes. For reactions in a fluid phase, multiply the expression by the fluid volume fraction θ . Similarly, solid phase reaction expressions include the bulk density, ρ_b , and gas phase reactions include the gas volume fraction, a_v .

The following expressions define some common types of reactions:

$$\begin{aligned}
 R_{Li} &= -\theta \frac{\ln 2}{\lambda_{Li}} c_i && \text{Radioactive decay — liquid} \\
 R_{Pi} &= -\rho_b \frac{\ln 2}{\lambda_{Pi}} \left(\frac{\partial c_{Pi}}{\partial c_i} \right) c_i && \text{Radioactive decay — solid} \\
 R_{Gi} &= -\frac{\ln 2}{\lambda_{Gi}} a_v \left(\frac{\partial c_{Gi}}{\partial c} \right) c_i && \text{Radioactive decay — gas} \\
 R_{Lk} &= \theta \zeta_{Li} c_i && \text{Creation from parent } c_{Li} \text{ — liquid} \\
 R_{Pk} &= \rho_b \zeta_{Pi} \left(\frac{\partial c_{Pi}}{\partial c_i} \right) c_i && \text{Creation from sorbed parent } c_{Pi} \text{ — solid} \\
 R_{Gk} &= -\zeta a_v \left(\frac{\partial c_{Gi}}{\partial c} \right) c_i && \text{Reaction — gas}
 \end{aligned}$$

where λ is the chemical half life, ζ is a reaction rate, and the subscripts L , P , and G denote liquid, solid, and gas phases, respectively. In the equations, the reactions either depend on liquid concentration c_i or solid phase concentrations c_{Pi} obtained using the sorption derivative with c_i or gas phase concentration c_{Gi} depending on the gas volume fraction, the volatilization, and the liquid concentration.

Reaction rates can vary with results from other equations in your model, such as temperature. For example, enter the Arrhenius rate law given in [Ref. 14](#):

$$\zeta_T = \zeta_R \exp\left[\frac{E_a(T - T_R)}{R_u T T_R}\right] \quad (6-35)$$

In [Equation 6-35](#), T denotes the current absolute temperature, T_R denotes the reference absolute temperature, E_a is the activation energy, and R_u is the universal gas constant.

Mass Transport in Fractures

When thin fractures occur in porous media, fluid flow tends to move faster along the fracture than in the surrounding media. The transport of chemical species therefore also occur also faster in the direction of the fractures.

The fluid flow in a fracture can be modeled using Darcy's law formulated in a thin sheet of porous medium (a fracture):

$$\mathbf{u} = \frac{\kappa}{\mu} \nabla_{\mathbf{t}} p$$

Here \mathbf{u} is the tangential Darcy velocity, κ is the fracture permeability, μ the fluid's dynamic viscosity, and $\nabla_{\mathbf{t}} p$ is the tangential gradient of the fluid pressure.

The equation to solve for mass transport of species c_i in a thin fracture, embedded in a porous media, is derived from [Equation 6-28](#). The resulting equation is:

$$d_{\text{fr}} \left(\frac{\partial \rho_b c_{\text{p},i}}{\partial t} + \frac{\partial \varepsilon_{\text{p}} c_i}{\partial t} + \nabla_{\mathbf{t}} \cdot (D_{\text{e},i} \nabla_{\mathbf{t}} c_i) + \mathbf{u} \cdot \nabla_{\mathbf{t}} c_i \right) = d_{\text{fr}} R_i + d_{\text{fr}} S_i + n_0 \quad (6-36)$$

Here d_{fr} is the fracture thickness, $c_{\text{p},i}$ the amount of species adsorbed to (or desorbed from) the porous matrix (moles per unit dry weight of the solid), ε_{p} is the fracture porosity, and D_{e} is the effective diffusivity. The first two terms on the right hand side represent source terms from reactions, and n_0 corresponds to out-of plane flux from the adjacent porous domain.

In order to arrive at the tangential differential equation, the gradient is split into the contributions normal and tangential to the fracture:

$$\nabla c_i = \nabla_{\text{n}} c_i + \nabla_{\mathbf{t}} c_i$$

The normal gradient is defined in the direction normal to the boundary representing the fracture and the tangential gradient is defined along the boundary. Assuming that the variations in the normal (thin) direction of the fracture are negligible compared to those in the tangential direction, the gradient is simplified as:

$$\nabla c_i = \nabla_t c_i$$

Using [The Transport of Diluted Species in Fractures Interface](#), the transport along fracture boundaries alone is solved for. In this case the transport in the surrounding porous media neglected and the out-of plane flux n_0 vanishes.



See [Fracture](#) for more information about the boundary feature solving [Equation 6-36](#). See [The Transport of Diluted Species in Fractures Interface](#) for more information about the physics interface solving the equation on boundaries only.

References

1. R. Codina, “A discontinuity-capturing crosswind-dissipation for the finite element solution of the convection-diffusion equation”, *Computer Methods in Applied Mechanics and Engineering*, vol. 110, pp. 325–342, 1993.
2. P.V. Danckwerts, “Continuous flow systems: Distribution of residence times”, *Chem. Eng. Sci.*, vol. 2, no. 1, 1953.
3. R.J. Millington and J.M. Quirk, “Permeability of Porous Solids”, *Trans. Faraday Soc.*, vol. 57, pp. 1200–1207, 1961.
4. R.D. Burnett and E.O. Frind, “An Alternating Direction Galerkin Technique for Simulation of Groundwater Contaminant Transport in Three Dimensions: 2. Dimensionality Effects”, *Water Resour. Res.*, vol. 23, no. 4, pp. 695–705, 1987.
5. J. Bear, *Hydraulics of Groundwater*, McGraw Hill, 1979.
6. J. Bear, *Dynamics of Fluids in Porous Media*, Elsevier Scientific Publishing, 1972.
7. D.M. Mackay, D.L. Freyberg, P.V. Roberts, and J.A. Cherry, “A Natural Gradient Experiment on Solute Transport in a Sand Aquifer: 1. Approach and Overview of Plume Movement”, *Water Resour. Res.*, vol. 22, no. 13, pp. 2017–2030, 1986.
8. H.M.F. Freundlich, “Über die Adsorption in Lösungen” (in German), *Z. Phys. Chem.*, vol 57, pp. 385–470, 1906

9. I. Langmuir, “The Constitution and Fundamental Properties of Solids and Liquids, Part I Solids”, *J. Amer. Chem. Soc.*, vol. 38, pp. 2221–2295, 1916.
10. J. Toth, “State equation of the solid gas interface layer”, *Acta Chem. Acad. Hung.*, vol. 69, pp. 311–317, 1971.
11. S. Brunauer, P.H. Emmett, E. Teller, “Adsorption of gases in multimolecular layers”, *J. Am. Chem. Soc.*, vol. 60 (2), pp. 309–319, 1938.
12. C.W. Fetter, *Contaminant Hydrogeology*, Prentice Hall, 1999.
13. J. Bear and A. Verruijt, *Modeling Groundwater Flow and Pollution*, D. Reidel Publishing, 1994.
14. I. Langmuir, “Chemical Reactions at Low Temperatures”, *J. Amer. Chem. Soc.*, vol. 37, 1915.
15. J.M. Coulson and J.F. Richardson, *Chemical Engineering*, vol. 2, 4th ed., Pergamon Press, Oxford, U.K., 1991.
16. J.M. Coulson and J.F. Richardson, *Chemical Engineering*, vol. 1, 4th ed., Pergamon Press, Oxford, U.K., 1991.
17. D.E Rosner, *Transport Processes in Chemically Reacting Flow Systems*, ISBN-13: 978-1483130262, Butterworth–Heinemann, 1986.
18. R.B. Bird, W.E. Stewart, and E.N. Lightfoot, *Transport Phenomena*, 2nd ed., John Wiley & Sons, Inc., 2007.

Theory for the Transport of Concentrated Species Interface

The Transport of Concentrated Species Interface theory is described in this section:

- [Multicomponent Mass Transport](#)
- [Multicomponent Gas Diffusion: Maxwell–Stefan Description](#)
- [Multicomponent Diffusivities](#)
- [Multicomponent Diffusion: Mixture-Averaged Approximation](#)
- [Multispecies Diffusion: Fick’s Law Approximation](#)
- [Multicomponent Thermal Diffusion](#)
- [Regularization of Reaction Rate Expression](#)
- [References for the Transport of Concentrated Species Interface](#)

Multicomponent Mass Transport

Suppose a reacting flow consists of a mixture with $i = 1, \dots, Q$ species and $j = 1, \dots, N$ reactions. [Equation 6-37](#) then describes the mass transport for an individual species:

$$\frac{\partial}{\partial t}(\rho\omega_i) + \nabla \cdot (\rho\omega_i\mathbf{u}) = -\nabla \cdot \mathbf{j}_i + R_i \quad (6-37)$$

where, ρ (SI unit: kg/m^3) denotes the mixture density and \mathbf{u} (SI unit: m/s) the mass averaged velocity of the mixture. The remaining variables are specific for each of the species, i , being described by the mass transfer equation:

- ω_i is the mass fraction (1)
- \mathbf{j}_i (SI unit: $\text{kg}/(\text{m}^2 \cdot \text{s})$) is the mass flux relative to the mass averaged velocity, and
- R_i (SI unit: $\text{kg}/(\text{m}^3 \cdot \text{s})$) is the rate expression describing its production or consumption.

The relative mass flux vector \mathbf{j}_i can include contributions due to molecular diffusion, mass flux due to migration in an electric field, and thermal diffusion.

Summation of the transport equations over all present species gives [Equation 6-38](#) for the conservation of mass

$$\frac{\partial \rho}{\partial t} + \nabla \cdot (\rho \mathbf{u}) = 0 \quad (6-38)$$

assuming that

$$\sum_{i=1}^Q \omega_i = 1, \quad \sum_{i=1}^Q \mathbf{j}_i = 0, \quad \sum_{i=1}^Q R_i = 0$$

Using the mass conservation equation, the species transport for an individual species, i , is given by:

$$\rho \frac{\partial}{\partial t}(\omega_i) + \rho(\mathbf{u} \cdot \nabla)\omega_i = -\nabla \cdot \mathbf{j}_i + R_i \quad (6-39)$$

$Q - 1$ of the species equations are independent and possible to solve for using [Equation 6-39](#). To compute the mass fraction of the remaining species, COMSOL Multiphysics uses the fact that the sum of the mass fractions is equal to 1:

$$\omega_1 = 1 - \sum_{i=2}^Q \omega_i \quad (6-40)$$

Multicomponent Gas Diffusion: Maxwell–Stefan Description

The Maxwell–Stefan formulation for a multicomponent mixture defines $N - 1$ (with N being the number of active species in the model) force balances according to

$$-\sum_{k \neq i} \frac{x_i x_k}{D_{ik}} \left(\frac{\mathbf{j}_i}{\omega_i \rho} - \frac{\mathbf{j}_k}{\omega_k \rho} \right) = \mathbf{d}_k - \sum_{k \neq i} \frac{x_i x_k}{D_{ik}} \left(\frac{D_k^T}{\omega_k \rho} - \frac{D_i^T}{\omega_i \rho} \right) \nabla \ln T \quad (6-41)$$

where

- D_{ik} (SI unit: m^2/s) are the binary Maxwell–Stefan diffusivities
- T (SI unit: K) is the temperature
- D_i^T (SI unit: $\text{kg}/\text{m}\cdot\text{s}$) are the thermal diffusion coefficients, and
- \mathbf{d}_k (SI unit: $1/\text{m}$) is the diffusional driving force acting on species k .

By inverting the above set of equations, the mass flux relative to the mass average velocity, \mathbf{j}_i , can be defined by the generalized Fick equations ([Ref. 1](#)):

$$\mathbf{j}_i = -\rho\omega_i \sum_{k=1}^Q \tilde{D}_{ik} \mathbf{d}_k - D_i^T \nabla \ln T \quad (6-42)$$

where \tilde{D}_{ik} (SI unit: m^2/s) are the multicomponent Fick diffusivities.

For ideal gas mixtures the diffusional driving force is (Ref. 1)

$$\mathbf{d}_k = \frac{1}{cR_g T} \left[\nabla p_k - \omega_k \nabla p - \rho_k \mathbf{g}_k + \omega_k \sum_{l=1}^Q \rho_l \mathbf{g}_l \right] \quad (6-43)$$

where

- c (SI unit: mol/m^3) is the total molar concentration
- R_g is the universal gas constant $8.314 \text{ J}/(\text{mol}\cdot\text{K})$
- p (SI unit: Pa) is the total pressure
- p_k (SI unit: Pa) is the partial pressure, and
- ρ_k (SI unit: kg/m^3) is the density of species k , and
- \mathbf{g}_k (SI unit: m/s^2) is an external force (per unit mass) acting on species k . In the case of an ionic species the external force arises due to the electric field.



When an external force applies equally to all species (such as for gravity), the last two terms disappear.

As can be seen in Equation 6-42 and Equation 6-43, the total diffusive flux for the species depends on the gradients of all species concentrations, temperature, and pressure as well as any external force on the individual species.

Using the ideal gas law, $p = c \cdot R_g \cdot T$, and the definition of the partial pressures, $p_k = x_k p$, the equation can be written as

$$\mathbf{d}_k = \nabla x_k + \frac{1}{p} \left[(x_k - \omega_k) \nabla p - \rho \omega_k \mathbf{g}_k + \omega_k \sum_{l=1}^Q \rho \omega_l \mathbf{g}_l \right] \quad (6-44)$$

The mole fraction x_k is given by

$$x_k = \frac{\omega_k M}{M_k} \quad (6-45)$$

and the mean molar mass M (SI unit: kg/mol) by

$$\frac{1}{M} = \sum_{i=1}^Q \frac{\omega_i}{M_i}$$

When using the Maxwell–Stefan diffusion model, the transport equations for the species' mass are

$$\begin{aligned} \rho \frac{\partial}{\partial t}(\omega_i) + \rho(\mathbf{u} \cdot \nabla)\omega_i &= \nabla \cdot \left(\rho \omega_i \sum_{k=1}^Q \tilde{D}_{ik} \mathbf{d}_k + D_i^T \frac{\nabla T}{T} \right) + R_i \\ \mathbf{d}_k &= \nabla x_k + \frac{1}{p} \left[(x_k - \omega_k) \nabla p - \rho \omega_k \mathbf{g}_k + \omega_k \sum_{l=1}^Q \rho \omega_l \mathbf{g}_l \right] \end{aligned} \quad (6-46)$$

Multicomponent Diffusivities

The multicomponent Fick diffusivities, \tilde{D}_{ik} , are needed to solve [Equation 6-46](#). The diffusivities are symmetric

$$\tilde{D}_{ik} = \tilde{D}_{ki}$$

and are related to the multicomponent Maxwell–Stefan diffusivities, D_{ik} , through the following relation ([Ref. 2](#))

$$\frac{x_i x_k}{D_{ik}} = -\omega_i \omega_k \frac{\sum_{j \neq i} (\text{adj} B_i)_{jk}}{\sum_{j \neq i} \tilde{D}_{ij} (\text{adj} B_i)_{jk}}, \quad (B_i)_{kj} = \tilde{D}_{kj} - \tilde{D}_{ij}, \quad i \neq j \quad (6-47)$$

where $(\text{adj} B_i)_{jk}$ is the jk^{th} component of the adjoint of the matrix B_i .

For low-density gas mixtures, the multicomponent Maxwell–Stefan diffusivities, D_{ij} , can be replaced with the binary diffusivities for the species pairs that are present.

Solving for [Equation 6-47](#) leads to a number of algebraic expressions for each of the components in the multicomponent Fick diffusivity matrix. For two- and three-component systems, these are implemented and solved directly by COMSOL Multiphysics. For instance, the component \tilde{D}_{12} in a ternary system is given by:

$$\tilde{D}_{12} = \frac{-\frac{\omega_1(\omega_2 + \omega_3)}{x_1 D_{23}} - \frac{\omega_2(\omega_1 + \omega_3)}{x_2 D_{13}} + \frac{\omega_3^2}{x_3 D_{12}}}{\frac{x_1}{D_{12} D_{13}} + \frac{x_2}{D_{12} D_{23}} + \frac{x_3}{D_{23} D_{13}}}$$

For four components or more, COMSOL Multiphysics obtains the multicomponent Fick diffusivities numerically through matrix inversion derived from the matrix properties defined in Ref. 2. The program starts with the multicomponent Maxwell–Stefan diffusivity matrix D_{ik} to compute the multicomponent Fick diffusivity matrix, \tilde{D}_{ik} , using the following equation:

$$\tilde{D}_{ij} = N_{ij} - q \quad (6-48)$$

where ij , the indices in the matrices \tilde{D} and N , range from 1 to the number of species, Q .

The elements of the matrix N in Equation 6-48 are defined as

$$N_{ij} = (P^{-1})_{ij} \quad (6-49)$$

where P^{-1} is the inverse of a matrix P defined as

$$P_{ij} = \frac{\omega_i \omega_j}{q} - \tilde{C}_{ij}$$

The matrix \tilde{C} in turn is defined as

$$\tilde{C}_{ij} = \begin{cases} \frac{x_i x_j}{D_{ij}} & i \neq j \\ -\sum_{k \neq j} \tilde{C}_{ik} & i = j \end{cases}$$

The term q in Equation 6-48 is a scalar value that provides numerical stability and should be of the same order of magnitude as the multicomponent Maxwell–Stefan diffusion coefficients. The physics interface therefore defines q as the sum of the multicomponent Maxwell–Stefan diffusion coefficients:

$$q = \sum_{i=1}^{n-1} \left(\sum_{j=i+1}^n D_{ij} \right)$$



This definition for q works well in most cases. In rare cases, it might be necessary to change the value to obtain convergence.

Because the multicomponent Fick diffusivity matrix is symmetric, it is sufficient to apply Equation 6-49 to the upper triangle elements of \mathbf{D} . The remaining elements are obtained by swapping the indices in the matrix.

Multicomponent Diffusion: Mixture-Averaged Approximation

The mixture-averaged diffusion model assumes that the relative mass flux due to molecular diffusion is governed by a Fick's law type approximation.

Assuming that the diffusive flux, relative to the mass averaged velocity, is proportional to the mole fraction gradient, the mass flux is defined as:

$$\mathbf{j}_{\text{md}, i} = -\rho_i D_i^m \frac{\nabla x_i}{x_i} \quad (6-50)$$

Here ρ_i is the density, and x_i the mole fraction of species i . Using the definition of the species density and mole fraction

$$\rho_i = \rho \omega_i, \quad x_i = \frac{\omega_i}{M_i} M$$

Equation 6-50 can be expressed in terms of the mass fractions (ω_i) in the manner of

$$\mathbf{j}_{\text{md}, i} = -\left(\rho D_i^m \nabla \omega_i + \rho \omega_i D_i^m \frac{\nabla M}{M} \right)$$

Using Equation 6-50 together with the Maxwell–Stefan equations, where isobaric and isothermal conditions have been assumed, the following expression for the mixture-averaged diffusion coefficients can be derived (Ref. 3):

$$D_i^m = \frac{1 - \omega_i}{\sum_{k \neq i}^N \frac{x_k}{D_{ik}}} \quad (6-51)$$

If instead the diffusive flux (relative to the mass averaged velocity) is assumed proportional to the mass fraction gradient, the mass flux is defined as:

$$\mathbf{j}_{\text{md},i} = -\rho_i D_i^{m*} \frac{\nabla \omega_i}{\omega_i} = -\rho D_i^{m*} \nabla \omega_i \quad (6-52)$$

For this assumption, using Equation 6-52 together with the Maxwell–Stefan equations, also assuming isobaric and isothermal conditions, the following expression for the mixture-averaged diffusion coefficients can be derived (Ref. 3):

$$\frac{1}{D_i^{m*}} = \sum_{k \neq i}^N \frac{x_k}{D_{ik}} + \frac{x_i}{1 - \omega_i} \sum_{k \neq i}^N \frac{\omega_k}{D_{ik}} \quad (6-53)$$

THE MIXTURE-AVERAGED DIFFUSION COEFFICIENT

When using the mixture-averaged model, the diffusion is proportional to a single diffusion coefficient. The coefficient describes the diffusion of species i relative to the remaining mixture and is referred to as the mixture-averaged diffusion coefficient. The coefficient is explicitly given in terms of the multicomponent Maxwell–Stefan diffusivities D_{ik} . As a consequence, no matrix inversion operation is required as for the Maxwell–Stefan diffusion model (when using four or more species). For low-density gas mixtures, the D_{ik} components can be replaced by the binary diffusivities for the species pairs present.

MIXTURE DIFFUSION CORRECTION

It should be noted that models for the multicomponent diffusivities based on Fick’s law are approximations. One drawback of this is that the net diffusive mass flux, the sum of all mass fluxes relative to the mass averaged velocity, is not constrained to zero. To account for this we add a flux, defined by a correction velocity \mathbf{u}_c , to enforce a zero net diffusive flux in the manner of:

$$\sum_{i=1}^N \mathbf{j}_{\text{md},i} = \sum_{i=1}^N \rho \omega_i (\mathbf{u}_{\text{d},i} + \mathbf{u}_c) = 0 \quad (6-54)$$

Hence the correction velocity is:

$$\mathbf{u}_c = -\sum_{i=1}^N \omega_i \mathbf{u}_{\text{d},i} \quad (6-55)$$

Here $\mathbf{u}_{\text{d},i}$ is the diffusion velocity resulting from the flux assumption in Equation 6-50 or Equation 6-52. Note that the correction velocity is a constant correction (same for all species), but varies in space.

Using the correction velocity together with Equation 6-50 (flux proportional to the mole fraction gradient), the resulting diffusive flux is

$$\mathbf{j}_{\text{md},i} = -\rho D_i^m \nabla \omega_i - \rho \omega_i D_i^m \frac{\nabla M}{M} + \rho \omega_i \sum_{i=1}^N \frac{M_i}{M} D_i^m \nabla x_i \quad (6-56)$$

If instead Equation 6-52 is used (flux proportional to the mass fraction gradient), the resulting diffusive flux is

$$\mathbf{j}_{\text{md},i} = -\rho D_i^{m*} \nabla \omega_i + \rho \omega_i \sum_{i=1}^N D_i^{m*} \nabla \omega_i \quad (6-57)$$

PORE WALL INTERACTIONS

In porous media, the diffusion models may be extended to account for species collisions with the pore walls.

For the **Fick's law** or the **Mixture-averaged** diffusion models, the diffusion coefficient D_i^M is corrected with the **Wall diffusion** coefficient D_i^W in the following way

$$D_i^{MW} = \left(\frac{1}{D_i^M} + \frac{1}{D_i^W} \right)^{-1}$$

For the **Maxwell-Stefan** diffusion model, the following term is added to the species force balance (Equation 6-41)

$$\dots + \frac{x_i}{D_{i,\text{eff}}^W} \left(\frac{\mathbf{j}_i}{\omega_i \rho} + \mathbf{u}_W \right) = \mathbf{d}_i + \dots$$

The wall velocity \mathbf{u}_W , representing the velocity of the fluid in a representative region adjacent to the pore wall, is here defined as

$$\mathbf{u}_W = - \frac{\frac{\nabla p_A}{p_A} + \sum_k \frac{x_k}{D_{k,\text{eff}}^W} \frac{\mathbf{j}_k'}{\omega_k \rho}}{\sum_k \frac{x_k}{D_{k,\text{eff}}^W}} \quad (6-58)$$

where the modified fluxes \mathbf{j}_k' have been calculated using the modified driving forces

$$\mathbf{d}_k' = \nabla x_k + \frac{1}{p} x_k \nabla p \quad (6-59)$$

It should be noted that \mathbf{u}_W can become nonzero also in the absence of pressure gradients. For a proper description of the fluid momentum balance, \mathbf{u}_W needs to be added either as a contributing velocity (Darcy's law) or as a corresponding volume force $\mathbf{F} = \mu\kappa^{-1}\mathbf{u}_W$ (Brinkman equations).

The Maxwell–Stefan model formulated in this way correctly captures the Klinkenberg effect, and has large similarities with other models in literature incorporating Knudsen diffusion such as the Dusty Gas Model and the (Modified) Binary Friction Model. In addition, for the limit of vanishing permeabilities ($\kappa \rightarrow 0$), the formulation reduces to the Lightfoot model for membrane transport.

ADDITIONAL TRANSPORT MECHANISMS

Apart from molecular diffusion, transport due to thermal diffusion and migration of charged species in an electric field can be accounted for by adding the following terms to the diffusive flux:

$$\mathbf{j}_i = \nabla \cdot \left(D_i^T \frac{\nabla T}{T} + \rho \omega_i z_i u_{m,i} \mathbf{F} \nabla \phi \right)$$

where

- D_i^T (SI unit: kg/(m·s)) is the thermal diffusion coefficient
- z_i (dimensionless) is the charge number
- $u_{m,i}$ the mobility of the i^{th} species, and
- ϕ (SI unit: V) is the electric potential.

Multispecies Diffusion: Fick's Law Approximation

Using a *Fick's law approximation*, the relative mass flux due to molecular diffusion is governed by

$$\mathbf{j}_{\text{md},i} = -\rho_i D_{i,kl}^F \frac{\nabla x_i}{x_i} \quad (6-60)$$

when assuming that the diffusive flux is proportional to the mole fraction gradient. If instead assuming that it is proportional to the mass fraction it becomes

$$\mathbf{j}_{\text{md},i} = -\rho D_{i,kl}^F \nabla \omega_i \quad (6-61)$$

In the equations above $D_{i,kl}^F$ represents a general diffusion matrix (SI unit: m^2/s) describing the diffusion of species i into the mixture. This form makes it possible to use any diffusion coefficient, matrix, or empirical model based on Fick's law. For example, in situations when the mass transport is not dominated by diffusion, an alternative is to use the diffusion coefficients at infinite dilution,

$$D_{i,kl}^F = D_i^0$$

These coefficients are typically more readily available compared to the binary diffusion diffusivities, especially for liquid mixtures.

The mixture diffusion correction described above for the mixture-averaged diffusion can also be applied in this case. Correspondingly, the resulting diffusive flux is

$$\mathbf{j}_{\text{md},i} = -\rho D_{i,kl}^F \nabla \omega_i - \rho \omega_i D_{i,kl}^F \frac{\nabla M}{M} + \rho \omega_i \sum_{i=1}^N \frac{M_i}{M} D_{i,kl}^F \nabla x_i \quad (6-62)$$

when using [Equation 6-60](#) and

$$\mathbf{j}_{\text{md},i} = -\rho D_{i,kl}^F \nabla \omega_i + \rho \omega_i \sum_{i=1}^N D_{i,kl}^F \nabla \omega_i \quad (6-63)$$

when instead using [Equation 6-61](#).

When using the Fick's Law approximation, [Additional Transport Mechanisms](#) can be accounted for in the same manner as described above for the mixture-averaged approximation.

Multicomponent Thermal Diffusion

Mass diffusion in multicomponent mixtures due to temperature gradients is referred to as the *Soret effect*. This occurs in mixtures with high temperature gradients and large variations in molecular weight (or size) of the species. Typically species with high molecular weight accumulate in lower temperature regions while the diffusion due to the Soret effect transports species with low molecular weight to higher temperature regions. In COMSOL Multiphysics, thermal diffusion is included by prescribing the thermal diffusion coefficients D_i^T . In a multicomponent mixture, the sum of the thermal diffusion coefficients is zero:

$$\sum_{i=1}^Q D_i^T = 0$$

Regularization of Reaction Rate Expression

The flexibility of COMSOL means that a reaction can result in nearly any reaction rate contribution R_i^c to a mass fraction ω_i . But a reactant, ω_r , can physically only be consumed if $\omega_r > 0$ and a product, ω_k , can only be formed if $\omega_k < 1$. The Reaction feature in Transport of Concentrated Species Interface contains a way to regularize make the rate expression contributions comply to these restrictions.

When selected the “core”, or unregularized reaction rate contribution, R_i^c , to a mass fraction ω_i is replaced by

$$R_i = \frac{1}{2} \frac{R_i^c - |R_i^c|}{\max(\omega_i, \omega_i^{\text{dl}})} \max(\omega_i, 0) + \frac{1}{2} \frac{R_i^c + |R_i^c|}{\max(1 - \omega_i, \omega_i^{\text{dl}})} \max(1 - \omega_i, 0) \quad (6-64)$$

The first term on the right hand side of Equation 6-64 is active if $R_i^c < 0$, that is if ω_i is a reactant. The reaction rate contribution, R_i , is equal to the “core” reaction rate, R_i^c , as long as $\omega_i > \omega_i^{\text{dl}}$. As ω_i approaches zero, the regularization damps out negative R_i^c and for $\omega_i < 0$, R_i for reactant ω_i is equal to zero.

The second term on the right hand side of Equation 6-64 is active if $R_i^c > 0$, that is if ω_i is a product. The reaction rate contribution, R_i , is equal to the “core” reaction rate, R_i^c , as long as $\omega_i < 1 - \omega_i^{\text{dl}}$. As ω_i approaches one, the regularization damps out positive R_i^c and for $\omega_i > 1$, R_i for product ω_i is equal to zero.

The damping limits, ω_i^{dl} , should be in an order of magnitude that can be considered numerical noise for species i . The damping limits are per default set to $1e^{-6}$, which is appropriate for most applications. It can be advantageous to lower some limits when working with for example catalytic trace species and the limits can sometimes be raised to gain additional robustness.

References for the Transport of Concentrated Species Interface

1. C.F. Curtiss and R.B. Bird, “Multicomponent Diffusion”, *Ind. Chem. Res.*, vol. 38 pp. 2515–2522, 1999.
2. R.B. Bird, W.E. Stewart, and E.N. Lightfoot, *Transport Phenomena*, 2nd ed., John Wiley & Sons, 2005.
3. R.J. Kee, M.E. Coltrin, and P. Glarborg, *Chemically Reacting Flow*, John Wiley & Sons, 2003.

Theory for the Electrophoretic Transport Interface

The [Electrophoretic Transport Interface](#) models transport of charged and uncharged species, and in addition sets up a charge balance equation for the electrolyte potential.

The species concentrations are denoted, c_i (SI unit: mol/m³), and the potential, ϕ_l (SI unit: V).

The species are transported by diffusion, migration, and (optionally) convection according to the Nernst–Planck set of equations. The total flux of species i is denoted \mathbf{N}_i (SI unit: mol/(m²·s)) according to

$$\mathbf{N}_i = -D_i \nabla c_i - z_i u_{m,i} F c_i \nabla \phi_l + \mathbf{u} c_i = \mathbf{J}_i + \mathbf{u} c_i \quad (6-65)$$

where D_i (SI unit: m²/s) is the diffusion coefficient, z_i (1) the corresponding charge, $u_{m,i}$ (SI unit: s·mol/kg) the mobility and \mathbf{u} (SI unit: m/s) the velocity vector. \mathbf{J}_i denotes the molar flux relative to the convective transport (SI unit: mol/(m²·s)). For a detailed description of the theory of these equations and the different boundary conditions, see [Theory for the Transport of Diluted Species Interface](#).

CHARGE BALANCE EQUATION

The current vector, \mathbf{i}_l (A/m²), is defined as

$$\mathbf{i}_l = \sum_i z_i \mathbf{N}_i \quad (6-66)$$

where the summation is made over all species in the electrolyte.

The governing equation for the electrolyte potential is

$$\nabla \cdot \mathbf{i}_l = Q_l \quad (6-67)$$

where Q_l (SI unit: A/m³) is the electrolyte current source stemming from, for example, porous electrode reactions. For nonporous electrode domains this source term is usually zero.

PROTON AND HYDROXIDE CONCENTRATIONS AND ELECTRONEUTRALITY

Assuming the total number of species to be $N + 2$, the assumption of electroneutrality is

$$\sum_{i=1}^{N+2} z_i c_i = 0 \quad (6-68)$$

In water-based systems the species H^+ and OH^- are always present. The auto ionization reaction for water is



This reaction is fast, following the equilibrium relation

$$c_{H^+} c_{OH^-} = K_w \times 1 \text{ mol}^2 \text{ dm}^{-6} \quad (6-70)$$

where $K_w \approx 10^{-14}$.

Now, the electroneutrality condition, including the two additional species H^+ and OH^- , reads

$$c_{H^+} - c_{OH^-} + \sum_{i=1}^N z_i c_i = 0 \quad (6-71)$$

Combining these two equations results in the following algebraic expressions for the concentrations of H^+ and OH^- .

$$c_{H^+} = -\frac{\Sigma}{2} + \sqrt{\frac{\Sigma^2}{4} + K_w \times 1 \text{ mol}^2 \text{ dm}^{-6}} \quad (6-72)$$

and

$$c_{OH^-} = \frac{\Sigma}{2} + \sqrt{\frac{\Sigma^2}{4} + K_w \times 1 \text{ mol}^2 \text{ dm}^{-6}} \quad (6-73)$$

where

$$\Sigma = \sum_{i=1}^N z_i c_i \quad (6-74)$$

MASS BALANCE EQUATIONS FOR DISSOCIATION SPECIES

Assume a set of species S_i describing k dissociation steps from

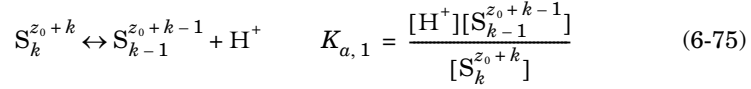

to

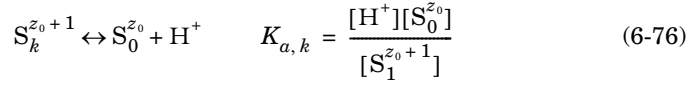

where z_0 is the charge (valence) of species S_0 (which has no dissociable protons) and $K_{a,j}$ is the acid (equilibrium) constant of the j th dissociation reaction. The brackets “[]” here represent the species activity. The charge of each species is always deductible from the index i according to z_{0+i} and will be dropped from now on.

If the proton activity is known, any species S_m may be expressed using any other species S_l according to

$$[S_m] = \frac{[H]^{m-l}[S_l]}{k-l} \prod_{j=k-m+1} K_{a,j} \quad (6-77)$$

if $m > l$ and

$$[S_m] = [H]^{m-l}[S_l] \prod_{j=k-l+1}^{k-m} K_{a,j} \quad (6-78)$$

if $l > m$.

Setting $m = i$ and denoting the flux of species i by \mathbf{N}_i using equation [Equation 6-65](#), the mass balance equation for the concentration c_i of each subspecies i in the dissociation chain is

$$\frac{\delta c_i}{\delta t} + \nabla \cdot \mathbf{N}_i = R_{\text{eq},i,k-i} - R_{\text{eq},i,k-i+1} + R_i \quad (6-79)$$

where $R_{\text{eq},i,j}$ is the reaction source stemming from the j th dissociation step (with $R_{\text{eq},i,k+1} = 0$), and R_i any additional reaction sources.

The reaction source contributions from the dissociation steps are generally not known, but may be canceled by taking the sum of all mass balance equations, resulting in

$$\sum_{i=0}^k \left(\frac{\delta c_i}{\delta t} + \nabla \cdot \mathbf{N}_i \right) = \sum_{i=0}^k R_i \quad (6-80)$$

AVERAGE IONIZATION FORMULATION FOR LARGE MOLECULES

Large protein molecules are typically subject to a large number of dissociation steps.

As an alternative way to a long chain of dissociation steps for describing protein transport, you can instead formulate the protein transport based on the average number of protons \bar{v} (1) removed from the molecule. \bar{v} is typically provided as a function of pH, based on experimental data. The average charge of the species then is $\bar{z} = z_0 - \bar{v}$, so that the flux of the species is written as:

$$\mathbf{N}_i = -D\nabla c_i - \bar{z}u_m F c_i \nabla \phi_l + \mathbf{u} c_i \quad (6-81)$$

and similarly the addition to the charge neutrality condition is $\bar{z}c_i$.

When considering the contribution to the current and the charge balance equation you need to take into account that the squared average charge, $\bar{z}^2 = (z_0 - \bar{v})^2$, is not equal to the “average squared charge”, $\bar{z}^2 = z_0^2 + 2z_0\bar{v} + \bar{v}^2 = \bar{z}^2 - \bar{v}^2 + \bar{v}^2$ (Ref. 1).

The addition to the current density vector is

$$\mathbf{i}_l = \dots - F(\bar{z}D_i \nabla c_i + \bar{z}^2 u_m c_i \nabla \phi_l) \quad (6-82)$$

The average number of protons removed from the proton typically depends on the pH. If the average number of removed protons depend only on the pH, the averaged squared number of protons removed can be written as

$$\bar{v}^2 = -c_{H^+} \frac{d}{dc_{H^+}} \bar{v} + \bar{v}^2 \quad (6-83)$$

And from this you can derive the average squared charge according to

$$\bar{z}^2 = -c_{H^+} \frac{d}{dc_{H^+}} \bar{v} + \bar{z}^2 = -c_{H^+} \frac{d}{dc_{H^+}} \bar{z} + \bar{z}^2 \quad (6-84)$$

DIFFUSIVITY-MOBILITY RELATIONS

The Stokes radius r of a molecule is related to the diffusivity according to

$$r = \frac{kT}{6\pi\mu D} \quad (6-85)$$

where μ (SI unit: Pa·s) is the dynamic viscosity and k the Boltzmann constant.

For small molecules, there is the frequently used Nernst–Einstein relation between the diffusivity and the mobility

$$u_m = \frac{D}{RT} \quad (6-86)$$

For larger molecules, such as proteins, the mobility may instead be calculated based on the Debye–Hückel–Henry expression (Ref. 2) according to

$$u_m = \frac{ef(\kappa r)}{6\pi\mu F(1 + \kappa r)} = \frac{Df(\kappa r)}{RT(1 + \kappa r)} \quad (6-87)$$

where κ (1/m) is the Debye parameter, which depends on the ionic strength of the solution, is defined for ideal solutions as

$$\kappa^2 = \frac{2e^2 N_A}{\varepsilon \varepsilon_0 kT} \sum_{i=1}^N z_i^2 c_i \quad (6-88)$$

where ε is the dielectric constant of the fluid and ε_0 the permittivity of free space. (z_i^2 should be used if available in the formula above when calculating the ionic strength).

The function f above is based on a sigmoidal function so that it ranges from 1 for $\kappa r = 0$ to 1.5 for $\kappa r = \infty$. Note that the Debye–Hückel–Henry expression approaches the Nernst–Einstein mobility as $r \rightarrow 0$.

For larger molecules (macro ions), where the distance between the charges is large compared to $1/\kappa$, the Linderström–Lang approximation postulates a smaller contribution of to the ionic strength so that the z -valent ion behaves as a monovalent ion with a z -fold concentration. For an assemble of $N - M$ smaller molecules and M macro ions, the Debye parameter then is defined as

$$\kappa^2 = \frac{2e^2 N_A}{\varepsilon \varepsilon_0 kT} \left(\sum_{i=1}^{N-M} z_i^2 c_i + \sum_{i=N-M+1}^N \text{abs}(z_i) c_i \right) \quad (6-89)$$

REFERENCES

1. R.A. Moshier, D.A. Saville, and W. Thormann, *The Dynamics of Electrophoresis*, VCH Verlagsgesellschaft mbH, Weinheim, Germany, 1992.
2. R.A. Moshier, P. Gebauer, J. Caslavská, and W. Thormann, “Computer Simulation and Experimental Validation of the Electrophoretic Behavior of Proteins. 2. Model Improvement and Application to Isotachopheresis,” *Anal. Chem.*, vol. 64, pp. 2991–2997, 1992.

Theory for the Surface Reactions Interface

The [Surface Reactions Interface](#) solves for an arbitrary number of surface concentrations, $c_{s,i}$ (SI unit: mol/m²), referring to species adsorbed on a reactive surface, and an arbitrary number of bulk concentrations $c_{b,k}$ (SI unit: mol/m³), referring to the species in the solid material that constitutes the bulk of the reactive surface.

In this section:

- [Governing Equations for the Surface Concentrations](#)
- [Governing Equations for the Bulk Concentrations](#)
- [ODE Formulations for Surface Concentrations](#)
- [Surface Reaction Equations on Deforming Geometries](#)
- [Reference for the Surface Reactions Interface](#)

Governing Equations for the Surface Concentrations

Transport of adsorbed species occurs in the tangential direction along the surface. The Surface Reactions interface models the tangential flux in the surface dimension, the *surface molar flux*, $\mathbf{N}_{t,i}$ (SI unit: mol/(m·s)) (the subscript t refers to the tangential direction), as governed by diffusion according to Fick's law:

$$\mathbf{N}_{t,i} = -D_{s,i} \nabla_t c_{s,i}$$

where $D_{s,i}$ (SI unit: m²/s) is the surface diffusion coefficient for species i .

The governing equation for the surface concentrations is written as:

$$\frac{\partial c_{s,i}}{\partial t} = -\nabla_t \cdot \mathbf{N}_{t,i} + R_{s,i} \quad (6-90)$$

where $R_{s,i}$ (SI unit: mol/(m²·s)) is the sum of all sources due to surface reactions and adsorption/desorption phenomena.

Of frequent interest for surface reaction kinetics are the fractional surface coverages, θ_i (dimensionless), of the species (with index i).

Writing the density of sites of the surface as Γ_s (SI unit: mol/m²) and the site occupancy number for each species as σ_i (dimensionless), the surface coverages can be calculated from:

$$\theta_i = \frac{\sigma_i c_{s,i}}{\Gamma_s}$$

(The site occupancy number accounts for the situation when a large species covers more than one site on the surface.)

For the case of monolayer adsorption, the sum of all fractional coverages of free and adsorbed sites is unity, and hence the fraction of free sites on the surface, θ_* , can be calculated from:

$$\theta_* = 1 - \sum_i \theta_i$$

Governing Equations for the Bulk Concentrations

BULK SPECIES RATES AND GROWTH VELOCITY

The reaction rate for a bulk species of index k , being added to the bulk due to surface reactions is defined as $R_{b,k}$ (SI unit: mol/(s·m²)).

The reaction rate in mass basis, $r_{b,k}$ (SI unit: kg/(s·m²)) for species k , is given by:

$$r_k = M_k R_{b,k}$$

with M_k (SI unit: kg/mol) being the molar mass of the species.

Based on this, the species contribution to the bulk growth velocity, v_k (SI unit: m/s), is given by:

$$v_{b,k} = \frac{r_{b,k}}{\rho_k}$$

where ρ_k is the species density (SI unit: kg/m³).

TOTAL RATES AND VELOCITY

To get the corresponding total values, a summation for all bulk species is made according to:

$$R_{b, \text{tot}} = \sum_k R_{b, k}$$

$$r_{b, \text{tot}} = \sum_k r_{b, k}$$

$$v_{b, \text{tot}} = \sum_k v_{b, k}$$

FRACTIONAL RATES AND VELOCITY

The fractional deposition rates are calculated by:

$$R_{b, \text{frac}, k} = \frac{R_{b, k}}{R_{b, \text{tot}}}$$

$$r_{b, \text{frac}, k} = \frac{r_{b, k}}{r_{b, \text{tot}}}$$

$$v_{b, \text{frac}, k} = \frac{v_{b, k}}{v_{b, \text{tot}}}$$



The fractional deposition rates can be used as measures of the local fractional composition in a deposited layer at a certain thickness or time.

ACCUMULATED BULK QUANTITIES

By solving for the bulk species concentrations for each time step, the accumulated mass and thickness changes of the bulk material can be calculated.

The bulk concentration, $c_{b, k}$ (SI unit: mol/m²), for species k is governed by the equation:

$$\frac{\partial c_{b, k}}{\partial t} = R_{b, k} \quad (6-91)$$

The bulk concentration in mass basis, $m_{b, k}$ (SI unit: kg/m²) for a species k , can be derived from:

$$m_{b, k} = M_k c_{b, k}$$

leading to the bulk thickness $s_{b,k}$ (SI unit: m) of species k according to:

$$s_{b,k} = \frac{m_{b,k}}{\rho_k}$$

TOTAL BULK QUANTITIES

The total bulk concentration is calculated according to:

$$c_{b,\text{tot}} = \sum_k c_{b,k}$$

The deposited total mass, $m_{b,\text{tot}}$ (SI unit: kg/m^2) is

$$m_{b,\text{tot}} = \sum_k m_{b,k}$$

and the total bulk thickness, s_{tot} (SI unit: m) is

$$s_{b,\text{tot}} = \sum_k s_k$$

FRACTIONAL QUANTITIES

The fractional bulk concentration, bulk mass, and thickness (all dimensionless) are calculated according to:

$$c_{b,\text{frac},k} = \frac{c_{b,k}}{c_{b,\text{tot}}}$$

$$m_{b,\text{frac},k} = \frac{m_{b,k}}{m_{b,\text{tot}}}$$

$$s_{b,\text{frac},k} = \frac{s_{b,k}}{s_{b,\text{tot}}}$$

ODE Formulations for Surface Concentrations

The surface of a 1D geometry has a 0 dimension, hence no surface transport can be modeled and the governing equation is reduced to an ODE:

$$\frac{\partial c_{s,i}}{\partial t} = R_{s,i}$$

Surface Reaction Equations on Deforming Geometries

If a Surface Reaction interface is used in conjunction with a Deformed Geometry or a Moving Mesh interface, the boundary concentration can either be assumed to be transported with the deforming geometry (moving mesh), with no compensation for the stretching (the Compensate for boundary stretching check box is not selected), or the species can be assumed to “float” on the mesh (the Compensate for boundary stretching check box is selected, which is the default). In the latter case the following is assumed in regard to the coupling between the surface species and bulk species and the mesh movement:

- Expansion or contraction of the boundary dilutes or increases concentration of the species, respectively, so that the surface integral (in spatial coordinates) of the species is kept constant.
- Tangential mesh movement has no impact on the local concentration in spatial coordinates, that is, the tangential transport of surface and bulk species does not move with the mesh in the tangential direction.

In order to comply with the additional contributions to the mass balance, equations are added. First, the following terms are added to the right-hand side of [Equation 6-90](#) and [Equation 6-91](#), respectively.

$$-c_{s,i} \frac{\partial}{\partial t} \ln \partial A$$

$$-c_{b,k} \frac{\partial}{\partial t} \ln \partial A$$

where ∂A is the infinitesimal mesh area segment (area scale factor). The above terms account for the concentration change due to a fractional area change.

Second, the resulting unwanted tangential convection, imposed by the mesh movement, is compensated for by the adding following terms to the right-hand side of [Equation 6-90](#) and [Equation 6-91](#), respectively:

$$\nabla_t \cdot (c_{s,i} \mathbf{v}_{t, \text{mesh}})$$

$$\nabla_t \cdot (c_{b,k} \mathbf{v}_{t, \text{mesh}})$$

where $\mathbf{v}_{t,\text{mesh}}$ is the mesh velocity in the tangential direction.

This convective term needs often to be stabilized using methods such as streamline diffusion or isotropic diffusion.

Reference for the Surface Reactions Interface

1. R.J. Kee, M.E. Coltrin, and P. Glarborg, *Chemically Reacting Flow*, Chapter 11, John Wiley & Sons, 2003.

Theory for the Coupling of Mass Transport to Electrochemical Reactions

When relating the species fluxes at an electrode surface to the electrical currents, the general chemical reaction formula

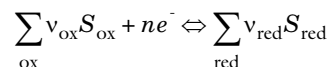

is used to define the stoichiometric coefficients, ν_i , with ν_i being positive (ν_{red}) for products and negative (ν_{ox}) for the reactants in a reduction reaction. The number of participating electrons, n , is always positive.

In this section:

- [Molar Sources and Sinks](#)
- [Mass Sources and Sinks](#)

Molar Sources and Sinks

The molar species fluxes, N_i (SI unit: mol/(m²·s)), perpendicular to an electrode-electrolyte interface are calculated by summing all the flux contributions from the electrode reactions, of index m , according to Faraday's law:

$$N_i = \sum_m \frac{\nu_{i,m} i_m}{n_m F}$$

where i_m is the local current density (SI unit: A/m²) of the electrochemical reaction, n_m the number of participating electrons and F (SI unit: C/mol) is *Faraday's constant*.

The molar species flux, N_i , is obtained from normal component of the molar species flux vector over the electrode-electrolyte interface:

$$N_i = \mathbf{N}_i \cdot \mathbf{n}$$

where \mathbf{n} is the normal vector of the boundary pointing into the domain.

For a porous electrode, the electrochemical reactions result in species source terms calculated from:

$$R_{i, \text{molar}} = -\sum_m a_{v,m} \frac{v_{i,m} i_m}{n_m F}$$

where $a_{v,m}$, (SI unit: m^2/m^3) is the specific surface area.

Mass Sources and Sinks

To compute the mass flux of a species, \mathbf{n}_i (SI unit: $\text{kg}/(\text{m}^2 \cdot \text{s})$), the molar flux is multiplied by the molar mass, M_i (SI unit: kg/mol), resulting in

$$\mathbf{n}_i \cdot \mathbf{n} = M_i N_i$$

for a mass flux boundary, and

$$R_{i, \text{mass}} = M_i R_{i, \text{molar}}$$

for a porous source term.

In the Transport of Concentrated Species interface, where a nonconservative formulation of the flux equations are used, the source term is corrected for the mass change in the species transporting phase according to

$$R_{w_i, \text{nonconservative}} = M_i R_{i, \text{molar}} - w_i \sum_i M_i R_{i, \text{molar}} \quad (6-92)$$



Equation 6-92 is for a domain source only, the flux expression over a boundary is not changed for a nonconservative formulation.

Theory for the Reacting Flow Interface

The following sections describe theory applicable for the Reacting Flow interface:

- [Pseudo Time Stepping for Mass Transport](#)
- [The Stefan Velocity](#)
- [The Chemical Reaction Rate](#)
- [Nonisothermal Reacting Flow](#)
- [References for the Reacting Flow Interfaces](#)

Pseudo Time Stepping for Mass Transport

In order to improve the solution robustness, pseudo time stepping can be used for the Transport of Concentrated Species interface when solving a stationary model. Using pseudo time stepping, a fictitious time derivative term:

$$\rho \frac{\omega_i - \text{nojac}(\omega_i)}{\Delta \tilde{t}}$$

is added to the left-hand side of the mass fraction equations. Here ρ is the fluid mixture density, ω_i is the mass fraction (dimensionless) of species i , and $\Delta \tilde{t}$ is the *pseudo time step*. Since $\omega_i - \text{nojac}(\omega_i)$ is always zero, this term does not affect the final solution. It does, however, affect the discrete equation system and effectively transforms a nonlinear iteration into a time step of size $\Delta \tilde{t}$.



For a description of the pseudo time step term for the Navier–Stokes equations and the pseudo time step see [and Pseudo Time Stepping](#) in the *COMSOL Multiphysics Reference Manual*.

The Stefan Velocity

Heterogeneous reactions on fluid-solid surfaces can affect the mass, momentum, and energy balances at the interface separating the fluid and the solid. On the reacting surface, the production or destruction rate, $r_{s,i}$ (SI unit: $\text{mol}/(\text{m}^2 \cdot \text{s})$), of a fluid phase

species is balanced by the total mass flux of the species. The mass balance for species i on a boundary representing a fluid-solid interface is given by

$$\mathbf{n} \cdot (\mathbf{j}_i + \rho \omega_i \mathbf{u}) = r_{s,i} M_i \quad (6-93)$$

Here, \mathbf{n} is the unit normal pointing out of the fluid domain, \mathbf{u} is the mass averaged velocity of the fluid mixture (SI unit: m/s), \mathbf{j}_i denotes the mass flux of species i relative to the mixture (typically due to diffusion), and M_i is the species molar mass (SI unit: kg/mol). Summing the mass balances at the surface, over all species, results in an effective mixture velocity:

$$\mathbf{n} \cdot \rho \mathbf{u}_s = \sum_{i=1}^N r_{s,i} M_i \quad (6-94)$$

referred to as the Stefan velocity, here denoted \mathbf{u}_s . To reach Equation 6-94 the fact that the sum of all mass fractions is one, and that the sum of all relative diffusive fluxes is zero, was used.

Equation 6-94 implies that surface reactions result in a net flux between the surface and the domain. A net flux in turn corresponds to an effective convective velocity at the domain boundary; the Stefan velocity. It should be noted here that when solving for mass transport inside a fluid domain, an outer boundary of the domain corresponds to a position just outside of the actual physical wall (on the fluid side). The domain boundary does not coincide with the physical wall.

In most reacting flow models, the species mass fractions in the fluid domain are solved for without including the surface concentrations (mol per area) on exterior walls. One reason for this is that the surface reaction rates are often not known. In this case, surface reactions can be modeled either by applying a mass flux or prescribing the mass fraction, or a combination of both, on fluid boundaries adjacent to the reacting surface. The Stefan velocity on a fluid domain boundary is then defined as the net mass flux resulting from the boundary conditions applied:

$$\mathbf{n} \cdot \rho \mathbf{u}_s = \sum_{i=1}^N \mathbf{n} \cdot (\mathbf{j}_{0,i} + \rho \omega_{0,i} \mathbf{u}) \quad (6-95)$$

Here, the first term contains contributions from boundary conditions prescribing the mass flux, while the second contains contributions from boundary conditions prescribing the mass fractions. Contributions to the Stefan velocity can be added by

selecting **Account for Stefan velocity** in the Flux or Mass Fraction features in The Transport of Concentrated Species interface.

The resulting Stefan velocity based on mass transport boundary conditions is computed as

$$\mathbf{n} \cdot \mathbf{u}_s = \frac{\sum_{i=1}^N \mathbf{n} \cdot \mathbf{j}_{0,i}}{\rho \left(1 - \sum_i \omega_{i,0} \right)} \quad (6-96)$$

Using a Reacting Flow interface, the Stefan velocity, defined in the manner of Equation 6-96, is automatically computed and applied on boundaries corresponding to walls in the coupled fluid flow interface. The Stefan velocity is prescribed in the wall normal direction on the wall selection.

The Chemical Reaction Rate

For laminar flow, or when the **Turbulent-reaction model** is set to **None** in a feature (in Transport of Concentrated Species), the default (Automatic) reaction rate used by the feature is based on the mass action law. Consider a general reaction belonging to a set of j reactions and involving i species:

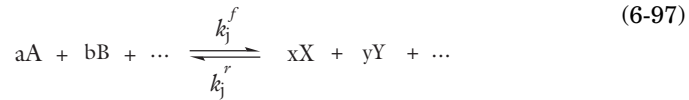

For such a reaction set, the reaction rates r_j (SI unit: mol/(m³·s)), can be described by the mass action law:

$$r_j = k_j^f \prod_{i \in \text{react}} c_i^{-v_{ij}} - k_j^r \prod_{i \in \text{prod}} c_i^{v_{ij}} \quad (6-98)$$

Here, k_j^f and k_j^r denote the forward and reverse rate constants, respectively. The concentration of species i is denoted c_i (SI unit: mol/m³). The stoichiometric coefficients are denoted v_{ij} , and are defined to be negative for reactants and positive for products. In practice, a reaction seldom involves more than two species colliding in a reacting step, which means that a kinetic expression is usually of order 2 or less (with respect to the involved concentrations).

In addition to the concentration dependence, the temperature dependence can be included by using the predefined Arrhenius expressions for the rate constants:

$$k = AT^n \exp\left(-\frac{E}{R_g T}\right)$$

Here, A denotes the frequency factor, n the temperature exponent, E the activation energy (SI unit: J/mol) and R_g the gas constant, 8.314 J/(mol·K). The pre-exponential factor, including the frequency factor A and the temperature factor T^n , is given the units $(\text{m}^3/\text{mol})^{\alpha-1}/\text{s}$, where α is the order of the reaction (with respect to the concentrations).

Nonisothermal Reacting Flow

When a Chemistry interface and a Heat Transfer interface are used in the Nonisothermal Reacting Flow multiphysics coupling, the heat equation is modified to account for reactions and diffusion.

In presence of chemical reactions, the enthalpy (SI unit: J/kg) is a function of temperature, pressure and the mixture composition. For a mixture of N components, the mass fractions verify the condition $\omega_1 + \dots + \omega_N = 1$. Therefore the enthalpy is a function of the temperature, pressure, and only $N - 1$ mass fractions:

$$\hat{H} = \hat{H}(T, p, \omega_1, \dots, \omega_{N-1})$$

Assuming the same velocity for the convection term of all components, the mass fractions follow the equation:

$$\rho \left(\frac{\partial}{\partial t} (\omega_i) + (\mathbf{u} \cdot \nabla) \omega_i \right) = -\nabla \cdot \mathbf{j}_i + R_i$$

On the other hand, using the chain rule, the enthalpy variation is written:

$$\rho \frac{D\hat{H}}{Dt} = \rho \left. \frac{\partial \hat{H}}{\partial T} \right|_{p, \omega_j} \frac{DT}{Dt} + \rho \left. \frac{\partial \hat{H}}{\partial p} \right|_{T, \omega_j} \frac{Dp}{Dt} + \rho \sum_{i=1}^{N-1} \left. \frac{\partial \hat{H}}{\partial \omega_i} \right|_{T, p, \omega_{j \neq i}} \frac{D\omega_i}{Dt}$$

which can be rewritten using the partial molar enthalpies:

$$\bar{H}_i = \left. \frac{\partial \hat{H}}{\partial n_i} \right|_{T, p, n_{j \neq i}}$$

$$\rho \frac{D\hat{H}}{Dt} = \rho \left. \frac{\partial \hat{H}}{\partial T} \right|_{p, \omega_j} \frac{DT}{Dt} + \rho \left. \frac{\partial \hat{H}}{\partial p} \right|_{T, \omega_j} \frac{Dp}{Dt} + \sum_{i=1}^N \frac{\bar{H}_i}{M_i} (-\nabla \mathbf{j}_i + R_i)$$

Additionally, the heat balance equation in terms of internal energy is written:

$$\rho \frac{DE}{Dt} = -\nabla \cdot \mathbf{q} + Q_{\text{vd}} + Q$$

where Q_{vd} is the heat source from viscous dissipation, and Q represents additional sources. The heat flux \mathbf{q} consists in a term of conduction and a term of diffusion:

$$\mathbf{q} = \mathbf{q}_{\text{cond}} + \mathbf{q}_{\text{diff}} = -k \nabla T + \sum_{i=1}^N \frac{\bar{H}_i}{M_i} \mathbf{j}_i$$

Enthalpy and internal energy are linked through the formula $E = \hat{H} - \frac{p}{\rho}$, we can thus rewrite the heat balance equation in terms of enthalpy:

$$\rho \left. \frac{\partial \hat{H}}{\partial T} \right|_{p, \omega_j} \frac{DT}{Dt} + \left(\rho \left. \frac{\partial \hat{H}}{\partial p} \right|_{T, \omega_j} - 1 \right) \frac{Dp}{Dt} + \sum_{i=1}^N \frac{\bar{H}_i}{M_i} (-\nabla \mathbf{j}_i + R_i) = -\nabla \cdot \mathbf{q} + Q_{\text{vd}} + Q$$

Introducing the heat capacity at constant pressure C_p (SI unit: J/(kg·m³), and the coefficient of thermal expansion α_p (SI unit: 1/K) gives:

$$\rho C_p \frac{DT}{Dt} - \alpha_p T \frac{Dp}{Dt} + \sum_{i=1}^N \frac{\bar{H}_i}{M_i} (-\nabla \mathbf{j}_i + R_i) = -\nabla \cdot \mathbf{q} + Q_{\text{vd}} + Q$$

The term with the pressure derivative is the work of pressure forces Q_p . The enthalpy variation due to the gradient of species mass flux can be partly simplified with the diffusion part of the heat flux. The heat source of reaction can be written in terms of enthalpies of reaction H_i instead of partial enthalpies (see). The temperature derivative term can be expanded to make the convective term appear. We finally obtain the temperature equation for a free flow with N species and M reactions:

$$\rho C_p \left[\frac{\partial T}{\partial t} + (\mathbf{u} \cdot \nabla) T \right] + \nabla \cdot (-k \nabla T) = Q_{\text{diff}} + Q_{\text{react}} + Q_{\text{vd}} + Q_p + Q$$

$$Q_{\text{diff}} = - \sum_{i=1}^N \mathbf{j}_i \cdot \nabla \left(\frac{\bar{H}_i}{M_i} \right)$$

$$Q_{\text{react}} = - \sum_{i=1}^M H_i r_i$$

$$Q_{\text{vd}} = (-p\mathbf{I} + \boldsymbol{\tau}) : \nabla \mathbf{u}$$

$$Q_p = \alpha_p T \left[\frac{\partial p}{\partial t} + (\mathbf{u} \cdot \nabla) p \right]$$

For reacting flows moving through the interstices of a porous medium, the heat sources of reaction and diffusion are only accounted for the temperature of the fluid phase. While the porosity is already accounted for in the diffusion term through the mass flux, the heat source of reaction has to be multiplied by the porosity. Also, in presence of a porous catalyst, both reactions in the bulk and reactions at the surface are accounted for in the reaction source term:

$$Q_{\text{react}} = -\varepsilon_p \sum_{i=1}^{M_{\text{bulk}}} H_i r_i - S_{\text{area}} \sum_{i=1}^{M_{\text{surf}}} H_i^s r_i^s$$

where ε_p is the porosity of the medium (SI unit: 1), S_{area} is the specific surface area (SI unit: 1/m), and r_i^s is the surface reaction rate (SI unit: mol/(m²·s)).

An additional source term is added to model convective heat transfer between the fluid and the porous matrix to get the temperature equation for nonisothermal reacting flows in porous media:

$$\rho_f C_{p,f} \left[\frac{\partial T_f}{\partial t} + (\mathbf{u} \cdot \nabla) T_f \right] + \nabla \cdot (-k_f \nabla T_f) = Q_{\text{diff}} + Q_{\text{react}} + Q_{\text{vd}} + Q_p + Q_{s,f} + Q$$

This equation is the one that is solved when the **Porous medium type** of the **Porous Medium** feature is set to **Local thermal nonequilibrium**, since both fluid and porous matrix temperatures are solved separately. With the **Local thermal equilibrium** approach, the equation is written for the common temperature, and in terms of effective material properties for the time derivative term and conduction term:

$$(\rho C_p)_{\text{eff}} \frac{\partial T}{\partial t} + \rho_f C_{p,f} (\mathbf{u} \cdot \nabla) T + \nabla \cdot (-k_{\text{eff}} \nabla T) = Q_{\text{diff}} + Q_{\text{react}} + Q_{\text{vd}} + Q_p + Q$$

References for the Reacting Flow Interfaces

1. H.A. Jakobsen, *Chemical Reactor Modeling: Multiphase Reactive Flows*, Springer, 2008.

Fluid Flow Interfaces

This chapter describes the physics interfaces found under the **Fluid Flow** branch ()

In this chapter:

- The Laminar Flow and Creeping Flow Interfaces
- The Darcy's Law Interface
- The Free and Porous Media Flow, Brinkman Interface
- The Free and Porous Media Flow, Darcy Interface
- The Brinkman Equations Interface
- Theory for the Laminar Flow and Creeping Flow Interfaces
- Theory for the Darcy's Law Interface
- Theory for the Free and Porous Media Flow, Brinkman Interface
- Theory for the Free and Porous Media Flow, Darcy Interface
- Theory for the Brinkman Equations Interface
- Theory for the Coupling of Fluid Flow to Electrochemical Reactions

The Laminar Flow and Creeping Flow Interfaces

In this section:

- [The Creeping Flow Interface](#)
- [The Laminar Flow Interface](#)
- [Domain, Boundary, Pair, and Point Nodes for Single-Phase Flow](#)



- [Theory for the Laminar Flow and Creeping Flow Interfaces](#)
-

In the *COMSOL Multiphysics Reference Manual*, see [Table 2-4](#) for links to common sections such as **Discretization**, **Consistent Stabilization**, **Inconsistent Stabilization**, and **Advanced Settings** sections, some of them accessed by clicking the **Show** button () and choosing the applicable option. You can also search for information: press F1 to open the **Help** window or Ctrl+F1 to open the **Documentation** window.

The Creeping Flow Interface

The **Creeping Flow (spf)** interface () is used for simulating fluid flows at very low Reynolds numbers for which the inertial term in the Navier–Stokes equations can be neglected. Creeping flow, also referred to as Stokes flow, occurs in systems with high viscosity or small geometrical length scales (for example, in microfluidics and MEMS devices). The fluid can be compressible or incompressible, as well as Newtonian or non-Newtonian.

The equations solved by the Creeping Flow interface are the Stokes equations for conservation of momentum and the continuity equation for conservation of mass.

The Creeping Flow interface can be used for stationary and time-dependent analyses.

The main feature is the **Fluid Properties** node, which adds the Stokes equations and provides an interface for defining the fluid material and its properties. Except where noted below, see [The Laminar Flow Interface](#) for all other settings.

PHYSICAL MODEL

By default, the **Neglect inertial term (Stokes flow)** check box is selected. If unchecked, the inertial terms are included in the computations.

DISCRETIZATION

By default, the Creeping Flow interface uses **P2+P1** elements. Contrary to general laminar and turbulent single-phase flow simulations employing purely linear P1+P1 elements, P2+P1 elements are well suited for most creeping flow simulations but are not in general fully conservative. Full conservation properties and high accuracy is obtained by selecting P2+P2 or P3+P3 elements.

Note that P1+P1, P2+P2, and P3+P3 discretizations (the so-called equal order interpolations) require streamline diffusion to be active.

The Laminar Flow Interface

The **Laminar Flow (spf)** interface () is used to compute the velocity and pressure fields for the flow of a single-phase fluid in the laminar flow regime. A flow remains laminar as long as the Reynolds number is below a certain critical value. At higher Reynolds numbers, disturbances have a tendency to grow and cause transition to turbulence. This critical Reynolds number depends on the model, but a classical example is pipe flow, where the critical Reynolds number is known to be approximately 2000.

The physics interface supports incompressible flow, weakly compressible flow (the density depends on temperature but not on pressure), and compressible flow at low Mach numbers (typically less than 0.3). It also supports flow of non-Newtonian fluids.

The equations solved by the Laminar Flow interface are the Navier–Stokes equations for conservation of momentum and the continuity equation for conservation of mass.

The Laminar Flow interface can be used for stationary and time-dependent analyses. Time-dependent studies should be used in the high-Reynolds number regime as these flows tend to become inherently unsteady.

When the Laminar Flow interface is added, the following default nodes are also added in the **Model Builder: Fluid Properties, Wall** (the default boundary condition is **No slip**), and **Initial Values**. Other nodes that implement, for example, boundary conditions and volume forces, can be added from the **Physics** toolbar or from the context menu displayed when right-clicking **Laminar Flow**.

SETTINGS

The **Label** is the default physics interface name.

The **Name** is used primarily as a scope prefix for variables defined by the physics interface. Physics interface variables can be referred to using the pattern `<name>.<variable_name>`. In order to distinguish between variables belonging to different physics interfaces, the `name` string must be unique. Only letters, numbers, and underscores (`_`) are permitted in the **Name** field. The first character must be a letter.

The default **Name** (for the first physics interface in the model) is `spf`.

About the Physics Interface Label Names

The label for a single-phase flow interface (the node name in the Model Builder) is dynamic and is reset according to the turbulence model and the neglect inertial term (Stokes flow) property set at the physics interface level. The availability also depends on the software license.

If the **Neglect inertial term (Stokes flow)** check box is selected, then the Label changes to **Creeping Flow**, which is the same Label that displays when that interface is added from the Model Wizard or Add Physics window.

PHYSICAL MODEL

Compressibility

Depending of the fluid properties and the flow regime, three options are available for the **Compressibility** option. In general the computational complexity increases from **Incompressible flow** to **Weakly compressible flow** to **Compressible flow (Ma<0.3)** but the underlying hypotheses are increasingly more restrictive in the opposite direction.

When the **Incompressible flow** option (default) is selected, the incompressible form of the Navier–Stokes and continuity equations is applied. In addition, the fluid density is evaluated at the **Reference pressure level** defined in this section. The **Reference temperature** is set to 293.15 K.

The **Weakly compressible flow** option models compressible flow when the pressure dependency of the density can be neglected. When selected, the compressible form of the Navier–Stokes and continuity equations is applied. In addition, the fluid density is evaluated at the **Reference pressure level** defined in this section.

When the **Compressible flow (Ma<0.3)** option is selected, the compressible form of the Navier–Stokes and continuity equations is applied. $Ma < 0.3$ indicates that the inlet and outlet conditions, as well as the stabilization, may not be suitable for transonic and supersonic flow. For more information, see [The Mach Number Limit](#).

Neglect Inertial Term (Stokes Flow)

For low Reynolds number flows, the inertial terms in the Navier–Stokes equations may be neglected.

Porous Media Domains

With the addition of various modules, the **Enable porous media domains** check box is available. Selecting this option, a **Fluid and Matrix Properties** node, a **Mass Source** node, and a **Forchheimer Drag** subnode are added to the physics interface. These are described for the **Brinkman Equations** interface in the respective module’s documentation. The **Fluid and Matrix Properties** can be applied on all domains or on a subset of the domains.

Porous Treatment of No Slip Condition

Porous treatment of no slip condition is available when **Enable porous media domains** is activated. It controls how the **No Slip** condition on **Wall** boundaries and **Interior Wall** boundaries adjacent to **Porous Medium** should be treated. The options are **Standard no slip formulation** (default) and **Porous slip**. The latter option provides a unified treatment when the porous matrix is fully resolved as well as when it is under resolved ensuring a smooth transition between regions with different resolutions; see No Slip under [Wall](#).

Include Gravity

When the **Include gravity** check box is selected, a global **Gravity** feature is shown in the interface model tree, and the buoyancy force is included in the Navier–Stokes equations.

Also, when the **Include gravity** check box is selected, the **Use reduced pressure** option changes the pressure formulation from using the total pressure (default) to using the reduced pressure. This option is suitable for configurations where the density changes are very small; otherwise, the default formulation can be used. For more information, see [Gravity](#)

Reference Values

Reference values are global quantities used to evaluate the density of the fluid when the **Incompressible flow** or the **Weakly compressible flow** option is selected.

Reference pressure level There are generally two ways to include the pressure in fluid flow computations: either to use the absolute pressure $p_A = p + p_{\text{ref}}$ or the gauge pressure p . When p_{ref} is nonzero, the physics interface solves for the gauge pressure whereas material properties are evaluated using the absolute pressure. The reference pressure level is also used to define the reference density.

Reference temperature The reference temperature is used to define the reference density.

Reference position When **Include gravity** is selected, the reference position can be defined. It corresponds to the location where the total pressure (that includes the hydrostatic pressure) is equal to the **Reference pressure level**.

DEPENDENT VARIABLES

The following dependent variables (fields) are defined for this physics interface — the **Velocity field u** and its components, and the **Pressure p** .

If required, the names of the field, component, and dependent variable can be edited. Editing the name of a scalar dependent variable changes both its field name and the dependent variable name. If a new field name coincides with the name of another field of the same type, the fields share degrees of freedom and dependent variable names. A new field name must not coincide with the name of a field of another type or with a component name belonging to some other field. Component names must be unique within a model except when two fields share a common field name.

CONSISTENT STABILIZATION

To enable this section, click the **Show More Options** button () and select **Stabilization** in the **Show More Options** dialog box.

There are two *consistent stabilization methods*: **Streamline diffusion** and **Crosswind diffusion**. Usually, both check boxes for these methods are selected by default and should remain selected for optimal performance. Consistent stabilization methods do not perturb the original transport equation. Streamline diffusion must be selected when using equal-order interpolation for pressure and velocity.

Select the **Use dynamic subgrid time scale** check box to estimate the influence of temporal variations in the velocity field, instead of using the inverse time step, in the consistent stabilization terms. This check box is selected by default

Select the **Limit small time steps effect on stabilization time scale** check box to prevent loss of stabilization at small time steps.

INCONSISTENT STABILIZATION

To enable this section, click the **Show More Options** button () and select **Stabilization** in the **Show More Options** dialog box.

There is usually just one *inconsistent stabilization method* — **Isotropic diffusion**. This method is equivalent to adding a term to the diffusion coefficient in order to dampen

the effect of oscillations by making the system somewhat less dominated by convection. If possible, minimize the use of the inconsistent stabilization method because by using it you no longer solve the original problem. By default, the **Isotropic diffusion** check box is not selected because this type of stabilization adds artificial diffusion and affects the accuracy of the original problem. However, this option can be used to get a good initial guess for underresolved problems.

If required, select the **Isotropic diffusion** check box and enter a **Tuning parameter** δ_{id} as a scalar positive value. The default value is 0.25 (a reasonable value to start with is roughly 0.5 divided by the element order). A higher value adds more isotropic diffusion.



- [Numerical Stability — Stabilization Techniques for Fluid Flow](#)

ADVANCED SETTINGS

To display this section, click the **Show More Options** button () and select **Advanced Physics Options** in the **Show More Options** dialog box. Normally these settings do not need to be changed.

The **Use pseudo time stepping for stationary equation form** is per default set to **Automatic from physics**. This option can add pseudo time derivatives to the equation when the **Stationary equation** form is used in order to speed up convergence. Pseudo time stepping is triggered when the Laminar Flow interface is selected in some multiphysics coupling features. Set **Automatic from physics** to **On** to apply pseudo time stepping also for laminar flows. Set it to **Off** to disable pseudo time stepping completely.

When **Use pseudo time stepping for stationary equation form** is set to **Automatic from physics** or **On**, a **CFL number expression** should also be defined. For the default **Automatic** option, the local CFL number (from the Courant–Friedrichs–Lewy condition) is determined by a PID regulator.

The **Use Block Navier-Stokes preconditioner** check box under **Linear solver** is available when the **Compressibility** option is set to **Incompressible flow**. When this check box is selected, the default solver for time-dependent study steps will use the Block Navier–Stokes preconditioner in iterative solvers for the velocity and pressure. Using this

preconditioner may result in shorter solution times for large time dependent problems with high Reynolds numbers.



- [Pseudo Time Stepping for Laminar Flow Models](#)
- [Domain, Boundary, Pair, and Point Nodes for Single-Phase Flow](#)
- [Theory for the Laminar Flow and Creeping Flow Interfaces](#)
- [Block Navier–Stokes](#) in the *COMSOL Multiphysics Reference Manual*.

DISCRETIZATION

The default discretization for Laminar Flow is **P1+P1** elements — that is, piecewise linear interpolation for velocity and pressure. This is suitable for most flow problems.

Some higher-order interpolations are also available, and they can be cost-effective options to obtain high accuracy for flows with low Reynolds numbers.

The **P2+P2** and **P3+P3** options, the equal-order interpolation options, are the preferred higher-order options because they have higher numerical accuracy than the mixed-order options **P2+P1** and **P3+P2**. The equal-order interpolation options do, however, require streamline diffusion to be active.



Flow Past a Cylinder: Application Library path **COMSOL_Multiphysics/Fluid_Dynamics/cylinder_flow**

Domain, Boundary, Pair, and Point Nodes for Single-Phase Flow

The following nodes, listed in alphabetical order, are available from the **Physics** ribbon toolbar (Windows users), **Physics** context menu (Mac or Linux users), or by right-clicking to access the context menu (all users).

- Boundary Stress
- Flow Continuity
- Fluid Properties
- Gravity
- Initial Values
- Inlet
- Line Mass Source¹
- Open Boundary
- Outlet
- Periodic Flow Condition
- Point Mass Source¹
- Porous Interface
- Pressure Point Constraint
- Symmetry
- Volume Force
- Wall

¹ A feature that may require an additional license



For 2D axisymmetric components, COMSOL Multiphysics takes the axial symmetry boundaries (at $r = 0$) into account and adds an **Axial Symmetry** node that is valid on the axial symmetry boundaries only.

In the *COMSOL Multiphysics Reference Manual*, see [Table 2-4](#) for links to common sections and [Table 2-5](#) to common feature nodes. You can also search for information: press F1 to open the **Help** window or Ctrl+F1 to open the **Documentation** window.



For a detailed overview of the functionality available in each product, visit <https://www.comsol.com/products/specifications/>

Fluid Properties

The **Fluid Properties** node adds the momentum and continuity equations solved by the physics interface, except for volume forces, which are added by the [Volume Force](#) feature. The node also provides an interface for defining the material properties of the fluid.

MODEL INPUTS

Fluid properties, such as density and viscosity, can be defined through user inputs, variables, or by selecting a material. For the latter option, additional inputs, for example temperature or pressure, may be required to define these properties.

Temperature

By default, the **Temperature** model input is set to **Common model input**, and the temperature is controlled from [Default Model Inputs](#) under **Global Definitions** or by a locally defined [Model Input](#). If a Heat Transfer interface is included in the component, it controls the temperature **Common model input**. Alternatively, the temperature field can be selected from another physics interface. All physics interfaces have their own tags (**Name**). For example, if a Heat Transfer in Fluids interface is included in the component, the **Temperature (ht)** option is available for T .

You can also select **User defined** from the **Temperature** model input in order to manually prescribe T .

Absolute Pressure

This input appears when a material requires the absolute pressure as a model input. The absolute pressure is used to evaluate material properties, but it also relates to the value of the calculated pressure field. There are generally two ways to calculate the pressure when describing fluid flow: either to solve for the absolute pressure or for a pressure (often denoted gauge pressure) that relates to the absolute pressure through a reference pressure.

The choice of pressure variable depends on the system of equations being solved. For example, in a unidirectional incompressible flow problem, the pressure drop over the modeled domain is probably many orders of magnitude smaller than the atmospheric pressure, which, when included, may reduce the stability and convergence properties of the solver. In other cases, such as when the pressure is part of an expression for the gas volume or the diffusion coefficients, it may be more convenient to solve for the absolute pressure.

The default **Absolute pressure** p_A is $p + p_{\text{ref}}$, where p is the dependent pressure variable from the Navier–Stokes or RANS equations, and p_{ref} is from the user input defined at the physics interface level. When p_{ref} is nonzero, the physics interface solves for a gauge pressure. If the pressure field instead is an absolute pressure field, p_{ref} should be set to 0.

The **Absolute pressure** field can be edited by clicking **Make All Model Inputs Editable** () and entering the desired value in the input field.



FLUID PROPERTIES

Density

The density can either be specified by a material, or by a **User defined** expression. The density in a material can depend on temperature and pressure, and these dependencies are automatically replaced by p_{ref} for weakly compressible flows and p_{ref} and T_{ref} for incompressible flows (as specified by the **Compressibility** setting at the physics interface level). If density variations with respect to pressure are to be included in the computations, **Compressibility** must be set to compressible. Any dependencies in the density on quantities other than temperature and pressure must be consistent with the **Compressibility** setting at the interface level.

Dynamic Viscosity

The **Dynamic viscosity** μ describes the relationship between the shear rate and the shear stresses in a fluid. Intuitively, water and air have low viscosities, and substances often described as thick (such as oil) have higher viscosities.

Volume Force

The **Volume Force** node specifies the volume force \mathbf{F} on the right-hand side of the momentum equation.

$$\rho \frac{\partial \mathbf{u}}{\partial t} + \rho(\mathbf{u} \cdot \nabla) \mathbf{u} = \nabla \cdot \left[-p \mathbf{I} + \mu(\nabla \mathbf{u} + (\nabla \mathbf{u})^T) - \frac{2}{3} \mu(\nabla \cdot \mathbf{u}) \mathbf{I} \right] + \mathbf{F}$$

If several volume-force nodes are added to the same domain, then the sum of all contributions are added to the momentum equation.

Initial Values

The initial values serve as initial conditions for a transient simulation or as an initial guess for a nonlinear solver in a stationary simulation. Note that for a transient compressible-flow simulation employing a material for which the density depends on

the pressure (such as air), discontinuities in the initial values trigger pressure waves even when the Mach number is small. The pressure waves must be resolved and this puts a restriction on the time step.

INITIAL VALUES

Initial values or expressions should be specified for the **Velocity field \mathbf{u}** and the **Pressure p** .

When **Include gravity** is selected and **Use reduced pressure** not selected in the interface **Physical model** section, the **Compensate for hydrostatic pressure approximation** (named **Compensate for hydrostatic pressure** for compressible flows) check box is available and selected by default. When it is selected, the hydrostatic pressure is automatically added to the pressure entered in p user input.

Wall

The **Wall** node includes a set of boundary conditions describing fluid-flow conditions at stationary, moving, and leaking walls. For turbulent flow, the description may involve wall functions and asymptotic expressions for certain turbulence variables.

BOUNDARY CONDITION

Select a **Boundary condition** for the wall.

- No Slip
- Slip
- Leaking Wall
- Navier Slip

No Slip

No slip is the default boundary condition to model solid walls. A no-slip wall is a wall where the fluid velocity relative to the wall velocity is zero. For a stationary wall that means that $\mathbf{u} = 0$.

The option for **Porous treatment of no slip condition** is available when **Enable porous media domains** is activated in the **Physical Model** section in the settings for the main physics interface node. It specifies how **Wall** boundaries and **Interior Wall** boundaries adjacent to porous domains are treated. When **Standard no slip formulation** is chosen, a common no slip condition is applied on all solid walls. When the default **Porous slip** is chosen, a blending analytic expression is instead applied on the corresponding wall boundaries adjacent to the porous medium domain. It results in a no slip condition in case the porous length scale is fully resolved by the mesh and a slip condition in the

opposite limit when the mesh is much coarser than the porous scale. A smooth transition between these limits is ensured. Note that the interpretation and usage of nonzero slip at the wall is the same as in the **Navier slip** boundary condition. By default, **Velocity formulation** is on and the treatment is based on an approximate reconstruction of the far field pressure gradient using the slip velocity at the wall. If the **Pressure-gradient formulation** is chosen, the local pressure gradient at the wall is employed.

Slip

The **Slip** option prescribes a no-penetration condition, $\mathbf{u} \cdot \mathbf{n} = 0$. It is implicitly assumed that there are no viscous effects at the slip wall and hence, no boundary layer develops. From a modeling point of view, this can be a reasonable approximation if the main effect of the wall is to prevent fluid from leaving the domain.

Leaking Wall

This boundary condition may be used to simulate a wall where fluid is leaking into or leaving the domain with the velocity $\mathbf{u} = \mathbf{u}_1$ through a perforated wall. The components of the **Fluid velocity** \mathbf{u}_1 on the leaking wall should be specified.

Navier Slip

This boundary condition enforces no-penetration at the wall, $\mathbf{u} \cdot \mathbf{n}_{\text{wall}} = 0$, and adds a tangential stress

$$\mathbf{K}_{\text{nt}} = -\frac{\mu}{\beta} \mathbf{u}_{\text{slip}}$$

where $\mathbf{K}_{\text{nt}} = \mathbf{K}_n - (\mathbf{K}_n \cdot \mathbf{n}_{\text{wall}}) \mathbf{n}_{\text{wall}}$, $\mathbf{K}_n = \mathbf{K} \mathbf{n}_{\text{wall}}$, and \mathbf{K} is the viscous stress tensor. β is a slip length, and $\mathbf{u}_{\text{slip}} = \mathbf{u} - (\mathbf{u} \cdot \mathbf{n}_{\text{wall}}) \mathbf{n}_{\text{wall}}$ is the velocity tangential to the wall.

The **Slip length** setting is per default set to **Factor of minimum element length**. The slip length β is then defined as $\beta = f_h h_{\text{min}}$, where h_{min} is the smallest element side and f_h is a user input. Select **User defined** from the **Slip length** selection list in order to manually prescribe β (SI unit: m).

In cases where the wall movement is nonzero, check **Account for the translational wall velocity in the friction force** to use $\mathbf{u} - \mathbf{u}_{\text{bnd}} - ((\mathbf{u} - \mathbf{u}_{\text{bnd}}) \cdot \mathbf{n}_{\text{wall}}) \mathbf{n}_{\text{wall}}$ instead of \mathbf{u}_{slip} in the friction force.

The Navier slip option is not available when selecting a turbulence model.

WALL MOVEMENT

This section contains controls to describe the wall movement relative to the lab (or spatial) frame.

The **Translational velocity** setting controls the translational wall velocity, \mathbf{u}_{tr} . The list is per default set to **Automatic from frame**. The physics automatically detects if the spatial frame moves. This can for example happen if an ALE interface is present in the model component. If there is no movement $\mathbf{u}_{tr} = \mathbf{0}$. If the frame moves, \mathbf{u}_{tr} becomes equal to the frame movement. \mathbf{u}_{tr} is accounted for in the actual boundary condition prescribed in the **Boundary condition** section.

Select **Zero (Fixed wall)** from **Translational velocity** selection list to prescribe $\mathbf{u}_{tr} = \mathbf{0}$.

Select **Manual** from **Translational velocity** selection list in order to manually prescribe **Velocity of moving wall**, \mathbf{u}_{tr} . This can for example be used to model an oscillating wall where the magnitude of the oscillations are very small compared to the rest of the model. Specifying translational velocity manually does not automatically cause the associated wall to move. An additional Moving Mesh node needs to be added from Definitions to physically track the wall movement in the spatial reference frame.

The **Sliding wall** option is appropriate if the wall behaves like a conveyor belt with the surface sliding in a tangential direction. A velocity is prescribed at the wall and the boundary itself does not have to actually move relative to the reference frame.

- For 3D components, values or expressions for the **Velocity of sliding wall** \mathbf{u}_w should be specified. If the velocity vector entered is not in the plane of the wall, COMSOL Multiphysics projects it onto the tangential direction. Its magnitude is adjusted to be the same as the magnitude of the vector entered.
- For 2D components, the tangential direction is unambiguously defined by the direction of the boundary. For this reason, the sliding wall boundary condition has different definitions in different space dimensions. A single entry for the **Velocity of the tangentially moving wall** U_w should be specified in 2D.

CONSTRAINT SETTINGS

This section is displayed by clicking the **Show More Options** button () and selecting **Advanced Physics Options** in the **Show More Options** dialog box. The **Constraints** settings can be set to **Automatic**, **Pointwise constraints**, **Nitsche constraints**, or **Weak constraints**. **Mixed constraints** can be selected when imposing a no slip condition exactly.

Depending on the constraint method selected, the following settings are available:

- **Apply reaction terms on** can be set to **Individual dependent variables** (default) or **All physics (symmetric)**. This setting is not available when **Nitsche constraints** is selected.
- Select **Elemental** (default) or **Nodal** under **Constraint method**. This setting is not available for **Nitsche constraints** or **Weak constraints**.



- [Theory for the Wall Boundary Condition](#)
 - [The Moving Mesh Interface in the COMSOL Multiphysics Reference Manual](#)
-

Inlet

This condition should be used on boundaries for which there is a net flow into the domain. To obtain a numerically well-posed problem, it is advisable to also consider the Outlet conditions when specifying an Inlet condition. For example, if the pressure is specified at the outlet, the velocity may be specified at the inlet, and vice versa. Specifying the velocity vector at both the inlet and the outlet may cause convergence difficulties.

BOUNDARY CONDITION

The available **Boundary condition** options for an inlet are **Velocity**, **Fully developed flow**, and **Pressure**. After selecting a **Boundary Condition** from the list, a section with the same or a similar name displays underneath. For example, if **Velocity** is selected, a **Velocity** section, where further settings are defined, is displayed.

VELOCITY

The **Normal inflow velocity** is specified as $\mathbf{u} = -\mathbf{n}U_0$, where \mathbf{n} is the boundary normal pointing out of the domain and U_0 is the normal inflow speed.

The **Velocity field** option sets the velocity vector to $\mathbf{u} = \mathbf{u}_0$. The components of the inlet velocity vector \mathbf{u}_0 should be defined for this choice.

PRESSURE CONDITIONS

This option specifies the normal stress, which in most cases is approximately equal to the pressure.

- For incompressible flow, the **Pressure** list has two options, **Static** and **Total**. For weakly compressible and compressible flow, the static pressure should be specified in the text field.
 - If **Pressure** is **Static**, and the reference pressure p_{ref} defined at the physics interface level, is equal to 0, the value of the pressure p_0 , at the boundary, is the absolute pressure. Otherwise, p_0 is the relative pressure at the boundary.
 - If **Pressure** is **Total**, the **Average** check box is available and cleared by default to prescribe the total pressure pointwise. If it is selected, the averaged total pressure is imposed in the weak forms instead.

When **Include gravity** is selected and **Use reduced pressure** not selected in the interface **Physical model** section, the **Compensate for hydrostatic pressure approximation** (named **Compensate for hydrostatic pressure** for incompressible flows) check box is available and selected by default. When it is selected, the hydrostatic pressure is automatically added to the pressure entered in p_0 user input.

- The **Suppress backflow** option adjusts the inlet pressure locally in order to reduce the amount of fluid exiting the domain through the boundary. If you clear the suppress backflow option, the inlet boundary can become an outlet depending on the pressure field in the rest of the domain.
- **Flow direction** controls in which direction the fluid enters the domain.
 - For **Normal flow**, it prescribes zero tangential velocity component.
 - For **User defined**, an **Inflow velocity direction** \mathbf{d}_u (dimensionless) should be specified. The magnitude of \mathbf{d}_u does not matter, only the direction. \mathbf{d}_u must point into the domain.

MASS FLOW

The mass flow at an inlet can be specified by the **Mass flow rate**, the **Pointwise mass flux**, the **Standard flow rate**, or the **Standard flow rate (SCCM)**.

The **Apply condition on each disjoint selection separately** check box is selected per default. When this setting is selected, the mass flow condition is applied separately on each disjoint selection. If this option is not selected, the condition is applied over the whole feature selection. The **Apply condition on each disjoint selection separately** should be disabled only if the flow conditions are known to be identical on each disjoint boundary.

Mass Flow Rate

The **Mass flow rate** option sets the integrated mass flow over the boundary selection, the **Normal mass flow rate** to a specific value, m . The mass flow is assumed to be parallel to the boundary normal, and the tangential flow velocity is set to zero.

For 2D components, the **Channel thickness** d_{bc} is used to define the area across which the mass flow occurs. This setting is not applied to the whole model. Line or surface integrals of the mass flow over the boundary evaluated during postprocessing or used in integration coupling operators do not include this scaling automatically. Such results should be appropriately scaled when comparing them with the specified mass flow.

Pointwise Mass Flux

The **Pointwise mass flux** sets the mass flow parallel to the boundary normal. The tangential flow velocity is set to zero. The mass flux is a model input, which means that COMSOL Multiphysics can take its value from another physics interface when available. When **User defined** is selected a value or function M_f should be specified for the **Mass flux**.

Standard Flow Rate

The **Standard flow rate** Q_{sv} sets a standard volumetric flow rate, according to the SEMI standard E12-0303. The mass flow rate is specified as the volumetric flow rate of a gas at standard density — the **Mean molar mass** M_n divided by a **Standard molar volume** V_m (that is, the volume of one mole of a perfect gas at standard pressure and standard temperature). The flow occurs across the whole boundary in the direction of the boundary normal and is computed by a surface (3D) or line (2D) integral. The tangential flow velocity is set to zero.

The standard density can be defined directly, or by specifying a standard pressure and temperature, in which case the ideal gas law is assumed. The options in the **Standard flow rate defined by** list are:

- **Standard density**, for which the **Standard molar volume** V_m should be specified.
- **Standard pressure and temperature**, for which the **Standard pressure** P_{st} and the **Standard temperature** T_{st} should be defined.

For 2D components, the **Channel thickness** d_{bc} is used to define the area across which the mass flow occurs. This setting is not applied to the whole model. Line or surface integrals of the mass flow over the boundary evaluated during postprocessing or used in integration coupling operators do not include this scaling automatically. Such results should be appropriately scaled when comparing them with the specified mass flow.

Standard Flow Rate (SCCM)

The **Standard flow rate (SCCM)** boundary condition is equivalent to the **Standard flow rate** boundary condition, except that the flow rate is entered directly in SCCMs (standard cubic centimeters per minute) without the requirement to specify units. Here, the dimensionless **Number of SCCM units** Q_{sccm} should be specified.

FULLY DEVELOPED FLOW

The **Fully developed flow** option adds contributions to the inflow boundary, which force the flow toward the solution for a fully developed channel flow. The channel can be thought of as a virtual extrusion of the inlet cross section. The inlet boundary must hence be flat in order for the fully developed flow condition to work properly. In 2D axisymmetric models, the inlet normal must be parallel to the symmetry axis.

Select an option to control the flow rate at the inlet:

- **Average velocity**, U_{av} .
- **Flow rate**, V_0 . Two-dimensional models also require an **Entrance thickness**, D_z , which is the out-of-plane thickness of the extruded entrance channel.
- **Average pressure**, P_{av} . Note that P_{av} is the average pressure on the inflow boundary.

The **Apply condition on each disjoint selection separately** check box is selected per default. When this setting is selected, the fully developed flow condition is applied separately on each disjoint selection. If this option is not selected, the condition is applied over the whole feature selection. The **Apply condition on each disjoint selection separately** should be disabled only if the flow conditions are known to be identical on each disjoint boundary.

The fully developed flow condition requires any volume force to be approximately aligned with the normal of the inlet boundary. The exception is gravity when the **Include gravity** setting is selected in the physics interface settings. Unless **Use reduced pressure** is also selected, an option to **Compensate for hydrostatic pressure** or **Compensate for hydrostatic pressure approximation** becomes available. It is selected per default and should only be deselected if the inlet normal is aligned with the gravity force and you want to specify an average pressure that includes the hydrostatic pressure.

CONSTRAINT SETTINGS

This section is displayed by clicking the **Show** button () and selecting **Advanced Physics Options**.

	<ul style="list-style-type: none">• Prescribing Inlet and Outlet Conditions• Normal Stress Boundary Condition
---	--

	Fully Developed Flow (Inlet)
---	------------------------------

Outlet

This condition should be used on boundaries for which there is a net outflow from the domain. To obtain a numerically well-posed problem, it is advisable to also consider the Inlet conditions when specifying an Outlet condition. For example, if the velocity is specified at the inlet, the pressure may be specified at the outlet, and vice versa. Specifying the velocity vector at both the inlet and the outlet may cause convergence difficulties. Selecting appropriate outlet conditions for the Navier–Stokes equations is a nontrivial task. Generally, if there is something interesting happening at an outflow boundary, the computational domain should be extended to include this phenomenon.

BOUNDARY CONDITION

The available **Boundary condition** options for an outlet are **Pressure**, **Fully developed flow**, and **Velocity**.

PRESSURE CONDITIONS

This option specifies the normal stress, which in most cases is approximately equal to the pressure. The tangential stress component is set to zero.

- For incompressible flow, the **Pressure** list has two options, **Static** and **Total**. For weakly compressible and compressible flow, the static pressure should be specified in the text field.
 - If **Pressure** is **Static**, and the reference pressure p_{ref} , defined at the physics interface level, is equal to 0, the value of the pressure p_0 , at the boundary, is the absolute pressure. Otherwise, p_0 is the relative pressure at the boundary.
 - If **Pressure** is **Total**, the **Average** check box is available and selected by default to prescribe the averaged total pressure in the weak forms. If it is cleared, the total pressure is imposed pointwise.

When **Include gravity** is selected and **Use reduced pressure** not selected in the interface **Physical model** section, the **Compensate for hydrostatic pressure approximation** (named **Compensate for hydrostatic pressure** for incompressible flows) check box is available and selected by default. When it is selected, the hydrostatic pressure is automatically added to the pressure entered in p_0 user input.

- The **Normal flow** option changes the no tangential stress condition to a no tangential velocity condition. This forces the flow to exit (or enter) the domain perpendicularly to the outlet boundary.
- The **Suppress backflow** check box is selected by default. This option adjusts the outlet pressure in order to reduce the amount of fluid entering the domain through the boundary.

VELOCITY

See the **Inlet** node [Velocity](#) section for the settings.

FULLY DEVELOPED FLOW

This boundary condition is applicable when the flow exits the domain into a long pipe or channel, at the end of which a flow profile is fully developed.

The channel can be thought of as a virtual extrusion of the outlet cross section. The outlet boundary must hence be flat in order for the fully developed flow condition to work properly. In 2D axisymmetric models, the outlet normal must be parallel to the symmetry axis.

Select an option to control the flow rate at the outlet:

- **Average velocity**, U_{av} .
- **Flow rate**, V_0 . Two-dimensional models also require an **Entrance thickness**, D_z , which is the out-of-plane thickness of the extruded entrance channel.
- **Average pressure**, P_{av} . Observe that P_{av} is the average pressure on the outflow.

The **Apply condition on each disjoint selection separately** check box is selected per default. When this setting is selected, the fully developed flow condition is applied separately on each disjoint selection. If this option is not selected, the condition is applied over the whole feature selection. The **Apply condition on each disjoint selection separately** should be disabled only if the flow conditions are known to be identical on each disjoint boundary.

The fully developed flow condition requires any volume force to be approximately aligned with the normal of the outlet boundary. The exception is gravity when the **Include gravity** setting is selected in the physics interface settings. Unless **Use reduced pressure** is also selected, an option to **Compensate for hydrostatic pressure** or **Compensate for hydrostatic pressure approximation** becomes available. It is selected per default and should only be deselected if the outlet normal is aligned with the gravity force and you want to specify an average pressure that includes the hydrostatic pressure.

CONSTRAINT SETTINGS

This section is displayed by clicking the **Show** button () and selecting **Advanced Physics Options**.

	Prescribing Inlet and Outlet Conditions
---	---

	Fully Developed Flow (Outlet)
---	-------------------------------

Symmetry

This node provides a boundary condition for symmetry boundaries. It should only be used when the geometry and expected solution have mirror symmetry. By using

symmetries in a model its size can be reduced by one-half or more, making this an efficient tool for solving large problems.

The **Symmetry** boundary condition prescribes no penetration and vanishing shear stresses. The boundary condition is a combination of a Dirichlet condition and a Neumann condition:

$$\mathbf{u} \cdot \mathbf{n} = 0, \quad \left(-p\mathbf{I} + \left(\mu(\nabla\mathbf{u} + (\nabla\mathbf{u})^T) - \frac{2}{3}\mu(\nabla \cdot \mathbf{u})\mathbf{I} \right) \right) \mathbf{n} = \mathbf{0}$$

$$\mathbf{u} \cdot \mathbf{n} = 0, \quad (-p\mathbf{I} + \mu(\nabla\mathbf{u} + (\nabla\mathbf{u})^T))\mathbf{n} = \mathbf{0}$$

for the compressible and incompressible formulations. The Dirichlet condition takes precedence over the Neumann condition, and the above equations are equivalent to the following equation for both the compressible and incompressible formulations:

$$\mathbf{u} \cdot \mathbf{n} = 0, \quad \mathbf{K} - (\mathbf{K} \cdot \mathbf{n})\mathbf{n} = \mathbf{0}$$

$$\mathbf{K} = \mu(\nabla\mathbf{u} + (\nabla\mathbf{u})^T)\mathbf{n}$$

BOUNDARY SELECTION

For 2D axial symmetry, a boundary condition does not need to be defined for the symmetry axis at $r = 0$. The software automatically provides a condition that prescribes $u_r = 0$ and vanishing stresses in the z direction and adds an **Axial Symmetry** node that implements these conditions on the axial symmetry boundaries only.

CONSTRAINT SETTINGS

This section is displayed by clicking the **Show** button () and selecting **Advanced Physics Options**.

Open Boundary

The **Open Boundary** condition describes boundaries in contact with a large volume of fluid. Fluid can both enter and leave the domain on boundaries with this type of condition.

BOUNDARY CONDITIONS

The **Boundary condition** options for open boundaries are **Normal stress** and **No viscous stress**.

Normal Stress

The **Normal stress** f_0 condition implicitly imposes $p \approx f_0$.

When **Include gravity** is selected and **Use reduced pressure** not selected in the interface **Physical model** section, the **Compensate for hydrostatic pressure approximation** (named **Compensate for hydrostatic pressure** for incompressible flows) check box is available and selected by default. When it is selected, the hydrostatic pressure is automatically added to the pressure entered in f_0 user input.

No Viscous Stress

The **No Viscous Stress** condition specifies vanishing viscous stress on the boundary. This condition does not provide sufficient information to fully specify the flow at the open boundary and must at least be combined with pressure constraints at adjacent points.

The **No viscous stress** condition prescribes:

$$\left(\mu(\nabla \mathbf{u} + (\nabla \mathbf{u})^T) - \frac{2}{3}\mu(\nabla \cdot \mathbf{u})\mathbf{I} \right) \mathbf{n} = \mathbf{0}$$

$$\mu(\nabla \mathbf{u} + (\nabla \mathbf{u})^T) \mathbf{n} = \mathbf{0}$$

for the compressible and the incompressible formulations. This condition can be useful in some situations because it does not impose any constraint on the pressure. A typical example is a model with volume forces that give rise to pressure gradients that are hard to prescribe in advance. To make the model numerically stable, this boundary condition should be combined with a point constraint on the pressure.

Boundary Stress

The **Boundary Stress** node adds a boundary condition that represents a general class of conditions also known as traction boundary conditions.

BOUNDARY CONDITION

The **Boundary condition** options for the boundary stress are **General stress**, **Normal stress**, and **Normal stress, normal flow**.

General Stress

When **General stress** is selected, the components for the **Stress F** should be specified. The total stress on the boundary is set equal to the given stress **F**:

$$\left(-p\mathbf{I} + \left(\mu(\nabla \mathbf{u} + (\nabla \mathbf{u})^T) - \frac{2}{3}\mu(\nabla \cdot \mathbf{u})\mathbf{I} \right) \right) \mathbf{n} = \mathbf{F}$$

$$(-p\mathbf{I} + \mu(\nabla \mathbf{u} + (\nabla \mathbf{u})^T)) \mathbf{n} = \mathbf{F}$$

for the compressible and the incompressible formulations.

This boundary condition implicitly sets a constraint on the pressure that for 2D flows is

$$p = 2\mu \frac{\partial u_n}{\partial n} - \mathbf{n} \cdot \mathbf{F} \quad (7-1)$$

If $\partial u_n / \partial n$ is small, Equation 7-1 states that $p \approx -\mathbf{n} \cdot \mathbf{F}$.

Normal Stress

Normal Stress is described for the Open Boundary node.

Normal Stress, Normal Flow

For **Normal stress, normal flow**, the magnitude of the **Normal stress** f_0 should be specified. The tangential velocity is set to zero on the boundary:

$$\mathbf{n}^T \left(-p\mathbf{I} + \left(\mu(\nabla \mathbf{u} + (\nabla \mathbf{u})^T) - \frac{2}{3}\mu(\nabla \cdot \mathbf{u})\mathbf{I} \right) \right) \mathbf{n} = -f_0, \quad \mathbf{t} \cdot \mathbf{u} = 0$$

$$\mathbf{n}^T (-p\mathbf{I} + \mu(\nabla \mathbf{u} + (\nabla \mathbf{u})^T)) \mathbf{n} = -f_0, \quad \mathbf{t} \cdot \mathbf{u} = 0$$

for the compressible and the incompressible formulations.

This boundary condition implicitly sets a constraint on the pressure that for 2D flows is

$$p = 2\mu \frac{\partial u_n}{\partial n} + f_0 \quad (7-2)$$

If $\partial u_n / \partial n$ is small, Equation 7-2 states that $p \approx f_0$.

When **Include gravity** is selected and **Use reduced pressure** not selected in the interface **Physical model** section, the **Compensate for hydrostatic pressure approximation** (named **Compensate for hydrostatic pressure** for incompressible flows) check box is available and selected by default. When it is selected, the hydrostatic pressure is automatically added to the pressure entered in f_0 or $p_{\text{hydro}}\mathbf{n}$ is added to \mathbf{F} depending of the selected option.

CONSTRAINT SETTINGS

This section is displayed by clicking the **Show** button () and selecting **Advanced Physics Options**.

If **Normal Stress, Normal Flow** is selected as the **Boundary condition**, then to **Apply reaction terms on** all dependent variables, the **All physics (symmetric)** option should be

selected. Alternatively, the **Individual dependent variables** could be selected to restrict the reaction terms as needed.

Periodic Flow Condition

The **Periodic Flow Condition** splits its selection into a source group and a destination group (the **Destination Selection** section is optional). Fluid that leaves the domain through one of the destination boundaries enters the domain through the corresponding source boundary. This corresponds to a situation where the geometry is a periodic part of a larger geometry. If the boundaries are not parallel to each other, the velocity vector is automatically transformed.

If the boundaries are curved, the orientation of the source must be specified manually (see [Orientation of Source](#)).

No input is required when **Compressible flow (Ma<0.3)** is selected for **Compressibility** under the **Physical Model** section for the physics interface. Typically when a periodic boundary condition is used with a compressible flow, the pressure is the same at both boundaries and the flow is driven by a volume force.

BOUNDARY SELECTION



The software usually automatically identifies the boundaries as either source boundaries or destination boundaries, as indicated in the selection list. This works fine for cases like opposing parallel boundaries. In other cases, right-click **Periodic Flow Condition** and select **Manual Destination Selection** to control the destination. By default it contains the selection that COMSOL Multiphysics identifies.

DESTINATION SELECTION

This section is available for specifying the destination boundaries, if needed, when the **Manual Destination Selection** option is selected in the context menu for the **Periodic Flow Condition** node. You can only select destination boundaries from the union of all source and destination boundaries.

FLOW CONDITION

This section is available when **Incompressible flow** is selected for **Compressibility** under the **Physical Model** section for the physics interface.

The **Flow Condition** at the boundary is specified through a value or expression for either the **Pressure difference**, $p_{\text{src}} - p_{\text{dst}}$, or the **Mass flow**, \dot{m} . The mass flow option ensures

a pressure difference is achieved across the source and destination boundaries. This pressure difference can, for example, drive the fully developed flow in a channel.

To set up a periodic boundary condition, both boundaries must be selected in the **Periodic Flow Condition** node. COMSOL Multiphysics automatically assigns one boundary as the source and the other as the destination. To manually set the destination selection, a **Destination Selection** subnode is available from the context menu (by right-clicking the parent node) or from the **Physics** toolbar, **Attributes** menu. All destination sides must be connected.

ORIENTATION OF SOURCE

To display this section, click the **Show More Options** button () and select **Advanced Physics Options** in the **Show More Options** dialog box. For information about the **Orientation of Source** section, see [Orientation of Source and Destination](#) in the *COMSOL Multiphysics Reference Manual*.

ORIENTATION OF DESTINATION

This section appears if the setting for **Transform to intermediate map** in the **Orientation of Source** section is changed from the default value, **Automatic**, and **Advanced Physics Options** is selected in the **Show More Options** dialog box. For information about the **Orientation of Destination** section, see [Orientation of Source and Destination](#) in the *COMSOL Multiphysics Reference Manual*.

MAPPING BETWEEN SOURCE AND DESTINATION

To display this section, click the **Show More Options** button () and select **Advanced Physics Options** in the **Show More Options** dialog box. For information about the **Mapping Between Source and Destination** section, see [Mapping Between Source and Destination](#) in the *COMSOL Multiphysics Reference Manual*.

Porous Interface

The **Porous Interface** condition is designed to properly account for a sudden jump in porosity, ϵ_p , across a boundary between different domains. It describes possible discontinuity of stress across the interface, and also reveals modified behavior of tangential velocity due to boundary layer on the upstream side of the interface. Choose among the following options under the **Continuity conditions**:

- **Velocity and stress** — stress continuity is invoked;

- **Velocity and porosity-corrected stress** (default)— the sum of stress and a contribution due to the inertial term being constant across the interface;
- **Velocity and porosity-corrected stress with loss** — the sum of the stress and a contribution due to the inertial term is lost in the downstream direction.

All three options give continuity of the velocity across the interface in constant-density flows, while in case of a jump in density:

- 1 give continuity of the mass flux (product of density and normal velocity) and tangential velocity;
- 2 account for the density-jump correction in the stress condition.

When **Velocity and porosity-corrected stress with loss** is chosen, a **Pressure loss model** needs to be specified. The options are:

- **User-defined loss coefficients** (default). Enter values for **Expansion loss coefficient** and **Contraction loss coefficient**;
- **Borda–Carnot**. Specify **Vena contracta model**.

Vena contracta model allows two options:

- **User defined** (default) — enter value of **Vena contracta coefficient**;
- **Weisbach** — enter values of **Lower limit** and **Exponent**.

Notice that the notions ‘expansion’ and ‘contraction’ used in this section correspond not to geometrical changes, but to the variations of the microscopic structure across the interface in the flow direction — increasing or decreasing porosity, ϵ_p , respectively.

Flow Continuity

The **Flow Continuity** condition is suitable for pairs where the boundaries match; it prescribes that the flow field is continuous across the pair.

The parts of the boundary where a source boundary lacks a corresponding destination boundary and vice versa will get conditions from other boundary conditions under the physics interface acting as fallback boundary conditions on the nonoverlapping parts. By default, the [Wall](#) node is used as fallback unless another feature has been selected for the boundary.

When the condition is set for pairs adjacent to domains with different porosity ϵ_p , it imposes conditions identical to the **Porous Interface** feature, which is designed to properly account for a sudden jump in porosity. See the section [Porous Interface](#) above

for further details (note that the **Flow Continuity** does not account for the density-jump corrections),



About Identity and Contact Pairs

Pressure Point Constraint

The **Pressure Point Constraint** condition can be used to specify the pressure level. If it is not possible to specify the pressure level using a boundary condition, the pressure level must be set in some other way, for example, by specifying a fixed pressure at a point.

PRESSURE CONSTRAINT

The relative pressure value is set by specifying the **Pressure** p_0 . If the reference pressure p_{ref} defined at the physics interface level is equal to zero, p_0 represents the absolute pressure.

When **Include gravity** is selected and **Use reduced pressure** not selected in the interface **Physical model** section, the **Compensate for hydrostatic pressure approximation** (named **Compensate for hydrostatic pressure** for incompressible flows) check box is available and selected by default. When it is selected, the hydrostatic pressure is automatically added to the pressure entered in p_0 user input.

CONSTRAINT SETTINGS

This section is displayed by clicking the **Show** button () and selecting **Advanced Physics Options**.

The **Apply reaction terms on** setting is set per default to **Individual dependent variables**. **All physics (symmetric)** cannot be used together with a segregated solver when fluid flow is coupled with Moving Mesh, Level Set, or Phase Field in Fluids.

Point Mass Source

This feature requires at least one of the following licenses: Battery Design Module, CFD Module, Chemical Reaction Engineering Module, Corrosion Module, Electrochemistry Module, Electrodeposition Module, Fuel Cell & Electrolyzer Module, Microfluidics Module, Pipe Flow Module, or Subsurface Flow Module.

The **Point Mass Source** feature models mass flow originating from an infinitely small domain centered around a point.

For the Reacting Flow in Porous Media, Diluted Species interface, which is available with the CFD Module, Chemical Reaction Engineering Module, or Battery Design Module, there are two nodes: one for the fluid flow (**Fluid Point Source**) and one for the species (**Species Point Source**).

SOURCE STRENGTH

The source **Mass flux**, \dot{q}_p , should be specified. A positive value results in mass being ejected from the point into the computational domain. A negative value results in mass being removed from the computational domain.

Point sources located on a boundary or on an edge affect the adjacent computational domains. This has the effect, for example, that a point source located on a symmetry plane has twice the given strength.



[Mass Sources for Fluid Flow](#) in the *COMSOL Multiphysics Reference Manual*

Line Mass Source

This feature requires at least one of the following licenses: Battery Design Module, CFD Module, Chemical Reaction Engineering Module, Corrosion Module, Electrochemistry Module, Electrodeposition Module, Fuel Cell & Electrolyzer Module, Microfluidics Module, Pipe Flow Module, or Subsurface Flow Module.

The **Line Mass Source** feature models mass flow originating from a tube region with infinitely small radius.

For the Reacting Flow in Porous Media, Diluted Species interface, which is available with the CFD Module, Chemical Reaction Engineering Module, or Battery Design Module, there are two nodes, one for the fluid flow (**Fluid Line Source**) and one for the species (**Species Line Source**).

SELECTION

The **Line Mass Source** feature is available for all dimensions, but the applicable selection differs between the dimensions.

MODEL DIMENSION	APPLICABLE GEOMETRICAL ENTITY
2D	Points
2D Axisymmetry	Points not on the axis of symmetry
3D	Edges

SOURCE STRENGTH

The source **Mass flux**, \dot{q}_1 , should be specified. A positive value results in mass being ejected from the line into the computational domain and a negative value means that mass is removed from the computational domain.

Line sources located on a boundary affect the adjacent computational domains. This, for example, has the effect that a line source located on a symmetry plane has twice the given strength.



[Mass Sources for Fluid Flow](#) in the *COMSOL Multiphysics Reference Manual*



Gravity

The **Gravity** global feature is automatically added when **Include gravity** is selected at the interface level in the **Physical Model** settings. It defines the gravity forces from the **Acceleration of gravity** value.

ACCELERATION OF GRAVITY

The **Acceleration of gravity** (SI unit m/s, default value $-g_{\text{const}}\mathbf{e}_z$ in 2D axial symmetry and 3D and $-g_{\text{const}}\mathbf{e}_y$ in 2D) is used to define the gravity forces. It should be a global quantity.

The Darcy's Law Interface

The **Darcy's Law (dl)** interface (), found under the **Porous Media and Subsurface Flow** branch () when adding a physics interface, is used to simulate fluid flow through interstices in a porous medium. It can be used to model low-velocity flows or media where the permeability and porosity are very small, and for which the pressure gradient is the major driving force and the flow is mostly influenced by the frictional resistance within the pores. Set up multiple **Darcy's Law** interfaces to model multiphase flows involving more than one mobile phase. The Darcy's Law interface can be used for stationary and time-dependent analyses.

The main feature is the **Porous Medium Properties** node, which provides interfaces for defining the fluid material and the porous matrix properties.

When this physics interface is added, the following default nodes are also added in the **Model Builder — Porous Medium, No Flow** (the default boundary condition), and **Initial Values**. Then, from the **Physics** toolbar, add other nodes that implement, for example, boundary conditions and mass sources. You can also right-click **Darcy's Law** to select physics features from the context menu.

SETTINGS

The **Label** is the default physics interface name.

The **Name** is used primarily as a scope prefix for variables defined by the physics interface. Refer to such physics interface variables in expressions using the pattern `<name>.<variable_name>`. In order to distinguish between variables belonging to different physics interfaces, the `name` string must be unique. Only letters, numbers, and underscores (`_`) are permitted in the **Name** field. The first character must be a letter.

The default **Name** (for the first physics interface in the model) is `dl`.

PHYSICAL MODEL

Enter a **Reference pressure level** p_{ref} (SI unit: Pa). The default value is `1[atm]`.

GRAVITY EFFECTS

By default there are no gravity effects added to Darcy's Law interface. Select the check box **Include gravity** to activate the acceleration of gravity. When this check box is selected, a global **Gravity** feature node is shown in the interface model tree.

Enter a value for the acceleration of gravity. The default value `g_const` is the predefined standard acceleration of gravity on earth.



For a detailed overview of the functionality available in each product, visit <https://www.comsol.com/products/specifications/>.

DISCRETIZATION

To display all settings available in this section, click the **Show More Options** button () and select **Advanced Physics Options** in the **Show More Options** dialog box.

You can choose the order of the shape functions used for the pressure variable solved by the Darcy's Law interface. The default shape functions are **Quadratic** Lagrange.

The **Compute boundary fluxes** check box is not activated by default. When this option is selected, the solver computes variables storing accurate boundary fluxes from each boundary into the adjacent domain.

If the check box is cleared, the COMSOL Multiphysics software instead computes the flux variables from the dependent variables using extrapolation, which is less accurate in postprocessing results but does not create extra dependent variables on the boundaries for the fluxes.



Also, the **Apply smoothing to boundary fluxes** check box is available if the previous check box is checked. The smoothing can provide a better behaved flux value close to singularities.

For details about the boundary fluxes settings, see [Computing Accurate Fluxes](#) in the *COMSOL Multiphysics Reference Manual*.

The **Value type when using splitting of complex variables** setting should in most pure mass transport problems be set to **Real** which is the default. It makes sure that the dependent variable does not get affected by small imaginary contributions, which can occur, for example, when combining a Time Dependent or Stationary study with a frequency-domain study. For more information, see [Splitting Complex-Valued Variables](#) in the *COMSOL Multiphysics Reference Manual*.

DEPENDENT VARIABLES

The dependent variable (field variable) is the **Pressure**. The name can be changed but the names of fields and dependent variables must be unique within a model.

	<ul style="list-style-type: none">• Domain, Boundary, Edge, Point, and Pair Nodes for the Darcy's Law Interface• Theory for the Darcy's Law Interface• Physical Constants in the <i>COMSOL Multiphysics Reference Manual</i>
	<ul style="list-style-type: none">• <i>Species Transport in the Gas Diffusion Layers of a PEM</i>: Application Library path Fuel_Cell_and_Electrolyzer_Module/Fuel_Cells/pem_gdl_species_transport_2d• <i>Steam Reformer</i>: Application Library path Chemical_Reaction_Engineering_Module/Reactors_with_Porous_Catalysts/steam_reformer• <i>Terzaghi Compaction</i>: Application Library path Subsurface_Flow_Module/Poromechanics/terzaghi_compaction

Domain, Boundary, Edge, Point, and Pair Nodes for the Darcy's Law Interface

The [Darcy's Law Interface](#) has the following domain, boundary, edge, point, and pair nodes, these nodes are available from the **Physics** ribbon toolbar (Windows users), **Physics** context menu (Mac or Linux users), or right-click to access the context menu (all users).

DOMAIN

- Porous Medium
- Unsaturated Porous Medium
- Dual Porosity Medium
- Dual Permeability Medium
- Unsaturated Dual Permeability Medium
- Mass Source
- Cross Section
- Initial Values
- Unsaturated Porous Medium
- ThicknessContributing Velocity
- Porous Electrode Coupling

BOUNDARY, EDGE, AND POINT

The following nodes (listed in alphabetical order) are available on exterior boundaries:

- Atmosphere/Gauge
- Electrode Surface Coupling
- Flux Discontinuity
- Fracture
- Hydraulic Head
- Inlet
- Interior Wall
- Line Mass Source
- Mass Flux
- No Flow
- Outlet
- Pervious Layer
- Point Mass Source
- Precipitation
- Pressure
- Pressure Head
- Reaction Coefficients¹
- Symmetry
- Thin Barrier

¹ This node is described for the Transport of Diluted Species Interface

The relevant physics interface condition at interior boundaries is continuity:

$$\mathbf{n} \cdot (\rho_1 \mathbf{u}_1 - \rho_2 \mathbf{u}_2) = 0$$

The continuity boundary condition ensures that the pressure and mass flux are continuous. In addition, the [Pressure](#) boundary condition is available on interior boundaries.

The continuity boundary condition provides continuity for the pressure and mass flux. In addition, the following boundary conditions are available on interior boundaries:

- [Pressure](#)
- [Pressure Head](#)
- [Hydraulic Head](#)
- [Interior Wall](#)
- [Pervious Layer](#)
- [Flux Discontinuity](#)
- [Fracture](#)
- [Thin Barrier](#)



Note that some of the above-mentioned domain or boundary conditions are only available with some products. For a detailed overview of the functionality available in each product, visit <https://www.comsol.com/products/specifications/>



In general, to add a node, go to the **Physics** toolbar, no matter what operating system you are using. Subnodes are available by clicking the parent node and selecting it from the **Attributes** menu.



For axisymmetric components, COMSOL Multiphysics takes the axial symmetry boundaries (at $r = 0$) into account and automatically adds an **Axial Symmetry** node that is valid on the axial symmetry boundaries only.



In the *COMSOL Multiphysics Reference Manual* see [Table 2-4](#) for links to common sections and [Table 2-5](#) to common feature nodes. You can also search for information: press F1 to open the **Help** window or Ctrl+F1 to open the **Documentation** window.

Porous Medium

The **Porous Medium** node adds the equations for modeling flow through porous domains. By default these are [Equation 7-3](#) and [Equation 7-4](#) (excluding any mass sources).

$$\frac{\partial}{\partial t}(\varepsilon_p \rho) + \nabla \cdot (\rho \mathbf{u}) = Q_m \quad (7-3)$$

$$\mathbf{u} = -\frac{\kappa}{\mu}\nabla p \quad (7-4)$$

For a steady-state problem the first term in [Equation 7-3](#) disappears. When [Mass Source](#) is active [Equation 7-4](#) is of the following form:

$$\mathbf{u} = -\frac{\kappa}{\mu}(\nabla p - \rho\mathbf{g}) \quad (7-5)$$

The **Porous Medium** feature has two default subfeatures — the [Fluid](#) subfeature where the fluid density ρ (SI unit: kg/m^3) and dynamic viscosity μ (SI unit: $\text{Pa}\cdot\text{s}$) are defined and the [Porous Matrix](#) subfeature where the permeability κ (SI unit: m^2) and porosity ε_p (dimensionless) are specified.

COORDINATE SYSTEM SELECTION

Select a coordinate system from the **Coordinate system** list for the interpretation of directions in anisotropic material properties. The default is the **Global coordinate system**, and the list contains any additional orthonormal coordinate system (except boundary coordinate systems) added under the **Definitions** node.

The subnodes inherit these coordinate system settings. In particular, the **Permeability** or **Hydraulic conductivity** (in the [Porous Matrix](#) subnode) should be set according to the coordinate system selected in this section.

FLOW MODEL

Define if the flow follows a linear or nonlinear pressure-velocity relationship.

- **Darcian flow** (default) defines a linear relationship using [Equation 7-3](#) and [Equation 7-4](#).
- **Non-Darcian flow** defines a nonlinear relationship using [Equation 7-3](#) and

$$\nabla p = -\frac{\mu}{\kappa}\mathbf{u} - \beta\rho|\mathbf{u}|\mathbf{u}$$

where the nonlinear parameter β (SI unit: $1/\text{m}$) is further specified in the [Porous Matrix](#) subfeature.

STORAGE MODEL

Define the time dependent storage term by selecting one of the following options from the drop-down menu:

- **From density and porosity** (default), uses the formulation of [Equation 7-3](#)

- **Linearized storage**, where the following linear equation is used to define the storage:

$$S_p = \varepsilon_p \chi_f + (1 - \varepsilon_p) \chi_p$$

- **Poroelastic storage**, where $S_p = \varepsilon_p \chi_f$
- **Quasistatic**, where the storage term is set to zero
- **User defined** to directly specify the storage coefficient S_p



- [Porous Material](#) in the *COMSOL Multiphysics Reference Manual*
- [About Darcian and Non-Darcian Flow](#) in the *Porous Media Flow Module User's Guide*
- [Storage Models](#) in the *Subsurface Flow Module User's Guide*



Note that some options are only available in some modules. For a detailed overview of the functionality available in each product, visit <https://www.comsol.com/products/specifications/>

Fluid

This node defines the material properties of the fluid of the [Porous Medium](#), the [Unsaturated Porous Medium](#), the [Dual Porosity Medium](#), the [Dual Permeability Medium](#), or the [Unsaturated Porous Medium](#) parent node.

MODEL INPUT

This section contains fields and values that are inputs for expressions defining material properties. If such user-defined property groups are added, the model inputs appear here.

FLUID PROPERTIES

The available options for the **Fluid type** are **Incompressible**, **Compressible**, **Compressible, linearized**, or **Ideal gas**. The selection determines how the density and compressibility of the fluid are set.

Incompressible

The default **Reference density** ρ_{ref} uses values **From material**. For **User defined** enter another value or expression.

Compressible

The default **Density** ρ uses values **From material**. For **User defined** enter another value or expression as a function of the absolute pressure. The compressibility of the fluid is computed from it.

Compressible, Linearized

The default **Reference density** ρ_{ref} and the **Fluid compressibility** χ_f use values **From material**. For **User defined** enter another value or expression. The fluid density increases linearly as a function of the fluid pressure.

Ideal Gas

For **Ideal gas** it uses the ideal gas law to describe the gas density. In this case, specify the thermodynamics properties. Select a **Gas constant type** — **Specific gas constant** R_s (the default) or **Mean molar mass** M_n (SI unit: J/(mol·K)). For **Mean molar mass** the universal gas constant $R = 8.314$ J/(mol·K) is used as the built-in physical constant. For both properties, the defaults use values **From material**. For **User defined** enter another value or expression.

For all fluid types specify the **Dynamic viscosity** μ (SI unit: Pa·s) uses values **From material**. For **User defined** enter another value or expression.

Porous Matrix

This node defines the porosity and material properties of the solid matrix of the [Porous Medium](#) or [Unsaturated Porous Medium](#) parent node.

MODEL INPUT

This section contains fields and values that are inputs for expressions defining material properties. If such user-defined property groups are added, the model inputs appear here.

MATRIX PROPERTIES

The default **Porosity** ε_p of the solid matrix is taken **From material**. In a **Porous Material** node, the porosity is defined as follows:

$$\varepsilon_p = 1 - \sum_i \theta_{si} - \sum_i \theta_{imfi}$$

where θ_{si} and θ_{imfi} are the porosities of the **Solid** and **Immobile Fluids** subnodes under the **Porous Material** node. See [Porous Material](#) in the *COMSOL Multiphysics Reference Manual* for more information.

Select **User defined** to enter a value or expression for ε_p .

If required by a **Storage model** in the parent node, specify the **Effective compressibility** of the porous matrix. The default value is $\chi_p = 10^{-4}$ 1/Pa.

Select a **Permeability model** to specify the capacity of the porous material to transmit flow. Which options are available depends on the **Flow model** setting in the parent node. Note that for the **Unsaturated Porous Medium** parent node only the Darcian Flow models are available.

Darcian Flow

If **Darcian flow** is selected in the parent **Porous medium** node, select between the following options for the **Permeability model**:

- Select **Permeability** (default) to define the permeability of the porous matrix. The default **Permeability** κ (SI unit: m^2) uses the value **From material**, as defined by the **Porous material**. For **User defined** select **Isotropic** to define a scalar value or **Diagonal** or **Symmetric** to define a tensor value.
- Select **Hydraulic conductivity** or define a combination of fluid permeability and dynamic viscosity. For **Hydraulic conductivity** K (SI unit: m/s) select **Isotropic** to define a scalar value or **Diagonal** or **Symmetric** to define a tensor value. The default is $2.94 \cdot 10^{-4}$ m/s.
- Select **Kozeny-Carman** to define the permeability from the porosity and mean particle diameter. Enter the mean **Particle diameter** d_p (SI unit: m), the default value is 0.5 mm.

Non-Darcian Flow

If **Non-Darcian flow** is selected in the parent node, select between the following options for the **Permeability model**:

- For **Forchheimer**, the default **Permeability** κ (SI unit: m^2) uses the value **From material**. Furthermore, the dimensionless **Forchheimer parameter** c_F can be defined. The default value is 0.55.
- If **Ergun** is selected, enter the mean **Particle diameter** d_p (default value: 0.5 mm).

- For **Burke–Plummer**, specify the mean **Particle diameter** d_p (default value: 0.5 mm).
- For **Klinkenberg**, the default **Permeability** κ_∞ (SI unit: m^2) uses the value **From material**. Enter the **Klinkenberg parameter** b_K . Its default value is 10^3 Pa.



- [About Darcian and Non-Darcian Flow](#) in the *Porous Media Flow Module User's Guide*
- [Permeability Models](#) in the *Porous Media Flow Module User's Guide*



Note that some options are only available in some modules. For a detailed overview of the functionality available in each product, visit <https://www.comsol.com/products/specifications/>

RETENTION MODEL

For an [Unsaturated Porous Medium](#) select between the following options for the retention model:

- **van Genuchten**, to specify the retention model using the van Genuchten relationship. Enter the constitutive relation constants α (the default value is 1, and the SI unit is $1/\text{m}$), n (default value is 2), and l (default value is 0.5). The constitutive parameter m is equal to $1 - 1/n$.
- **Brooks and Corey** to use the retention model according to the Brooks and Corey relationships.
- **User defined** to use a different retention model. Enter user defined expressions for the **Effective saturation** S_e , the **Liquid volume fraction** θ_l . The default is ε_p (the porosity variable). Specify the **Specific moisture capacity** C_m (SI unit: $1/\text{m}$). The default value is 0 ($1/\text{m}$). Enter an expression for the **Relative permeability** κ_r . The default value is 1.

If there is a residual volume of liquid that cannot move through the pore network, also enter a value between 0 and 1 for the **Residual liquid volume fraction** θ_r . The default value is 0.



[Retention and Permeability Relationships](#) in the *Subsurface Flow Module User's Guide*

Unsaturated Porous Medium

The **Unsaturated Porous Medium** node adds the Richards' equation (Equation 7-6) for flow in variably saturated porous media.

$$\rho \left(\frac{C_m}{\rho g} + S_c S_p \right) \frac{\partial p}{\partial t} + \nabla \cdot \rho \left(-\frac{\kappa_r \kappa}{\mu} (\nabla p + \rho g \nabla D) \right) = Q_m \quad (7-6)$$

The Unsaturated Porous Medium feature has two default subfeatures: the **Fluid** subfeature, where the fluid density ρ (SI unit: kg/m³) and viscosity μ (SI unit: Pa·s) are defined, and the **Porous Matrix** subfeature, where the permeability κ (SI unit: m²) and porosity ϵ_p (dimensionless) are specified as well as the retention model.

COORDINATE SYSTEM SELECTION

Select a coordinate system from the **Coordinate system** list for the interpretation of directions in anisotropic material properties. The default is the **Global coordinate system**, and the list contains any additional orthonormal coordinate system (except boundary coordinate systems) added under the **Definitions** node.

The subnodes inherit these coordinate system settings. In particular, the **Permeability** or **Hydraulic conductivity** (in the **Porous Matrix** subnode) should be set according to the coordinate system selected in this section.

STORAGE MODEL

With this option, define the first term in Equation 7-6. Therefore, choose from a drop-down menu one of the following formulations:

- From retention model
- Linearized storage (default)
- From liquid content
- User defined

If **From retention model** is chosen, the first term of Equation 7-6 accounts only for the specific moisture capacity C_m which is defined by the **Retention Model** in the **Porous Matrix** subnode:

$$\frac{C_m \partial p}{g \partial t}$$

For the option **Linearized storage** the storage coefficient S_p in Equation 7-6 is defined as

$$S_p = \varepsilon_p \chi_f + (1 - \varepsilon_p) \chi_p.$$

From liquid content enforces the first term of Equation 7-6 to be defined in terms of liquid volume fraction as

$$\frac{\partial(\rho\theta_l)}{\partial t}$$

and the **User defined** option allows to define the storage coefficient S_p in Equation 7-6 directly.



Note that some options are only available in some modules. For a detailed overview of the functionality available in each product, visit <https://www.comsol.com/products/specifications/>

Dual Porosity Medium

Use the Dual Porosity Medium if the flow through macropores is governed by Darcy's law and the micropores do not significantly contribute to the overall flow in the porous medium.

The feature has three default subfeatures —the **Fluid** subfeature where the fluid density ρ (SI unit: kg/m^3) and dynamic viscosity μ (SI unit: $\text{Pa}\cdot\text{s}$) are defined, the **Macropores** subfeature where the hydraulic properties of the macroporous matrix are defined, and the **Micropores** where the hydraulic properties of the microporous matrix are defined.

COORDINATE SYSTEM SELECTION

Select a coordinate system from the **Coordinate system** list for the interpretation of directions in anisotropic material properties. The default is the **Global coordinate system**, and the list contains any additional orthonormal coordinate system (except boundary coordinate systems) added under the **Definitions** node.

The subnodes inherit these coordinate system settings. In particular, the **Permeability** or **Hydraulic conductivity** (in the **Macropores** and **Micropores** subnodes) should be set according to the coordinate system selected in this section.

STORAGE MODEL

Choose from a drop-down menu one of the following formulations:

- **From density and porosity** (default), uses the formulation equivalent to Equation 7-3

- **Linearized storage**, where the following linear equation is used to define the storage in the macropores as $S_p = \varepsilon_p \chi_f + (1 - \varepsilon_p) \chi_p$ and in the micropores as $S_{p,m} = \varepsilon_{p,m} \chi_f + (1 - \varepsilon_{p,m}) \chi_p$.
- **Poroelastic storage**, where $S_p = \varepsilon_p \chi_f$ in the macropores and $S_{p,m} = \varepsilon_{p,m} \chi_f$ in the micropores.
- **Quasistatic**, where the storage term is set to zero
- **User defined** to directly specify the storage coefficient S_p and $S_{p,m}$ for the macro- and micropores respectively.



• [Storage Models](#) in the *Subsurface Flow Module User's Guide*

INTERPOROSITY FLOW

Specify the **Fluid Transfer Function** α_w which is used to calculate the interporosity flow, the mass exchange between macro- and microscale system:

$$Q_{ip} = \alpha_w (p_M - p_m) \quad (7-7)$$

with p_M being the pressure within the macropores and p_m the pressure within the micropores.



Find more information in the *Subsurface Flow Module User's Guide*

- [Dual Porosity & Dual Permeability Modeling](#)
- [Dual Porosity and Dual Permeability Theory](#)



Note that some options are only available in some modules. For a detailed overview of the functionality available in each product, visit <https://www.comsol.com/products/specifications/>

Dual Permeability Medium

Use the **Dual Permeability Medium** feature to model transport in a saturated dual permeability medium where Darcy's Law describes the transport in each system.

The feature has three default subfeatures —the **Fluid** subfeature where the fluid density ρ (SI unit: kg/m^3) and dynamic viscosity μ (SI unit: $\text{Pa}\cdot\text{s}$) are defined, the **Macropores**

subfeature where the hydraulic properties of the macroporous matrix are defined, and the [Micropores](#) where the hydraulic properties of the microporous matrix are defined.

COORDINATE SYSTEM SELECTION

Select a coordinate system from the **Coordinate system** list for the interpretation of directions in anisotropic material properties. The default is the **Global coordinate system**, and the list contains any additional orthonormal coordinate system (except boundary coordinate systems) added under the **Definitions** node.

The subnodes inherit these coordinate system settings. In particular, the **Permeability** or **Hydraulic conductivity** (in the [Macropores](#) and [Micropores](#) subnodes) should be set according to the coordinate system selected in this section.

STORAGE MODEL

With this option under the **Porous Medium** section, [Equation 7-3](#) is formulated with respect to a storage term (analogous to [Equation 4-4](#)). Therefore, choose from a drop-down menu one of the following formulations:

- **From density and porosity** (default), uses the formulation of [Equation 4-4](#)
- **Linearized storage**, where the following linear equation is used to define the storage:

$$S_{p,i} = \varepsilon_{p,i}\chi_f + (1 - \varepsilon_{p,i})\chi_{p,i}$$

with $i=M$ for the macropores and $i=m$ for the micropores.

- **Poroelastic storage**, where $S_{p,i} = \varepsilon_{p,i}\chi_f$
- **Quasistatic**, where the storage term is set to zero
- **User defined** to directly specify the storage coefficient S_p



- [Storage Models](#) in the *Subsurface Flow Module User's Guide*
-

INTERPOROSITY FLOW

Specify the **Fluid Transfer Function** α_w which is used to calculate the interporosity flow, which is the mass exchange between macro- and microscale system:

$$Q_{ip} = \alpha_w(p_M - p_m) \tag{7-8}$$

with p_M being the pressure in the macropores and p_m the pressure in the micropores.

?	<p>Find more information in the <i>Subsurface Flow Module User's Guide</i></p> <ul style="list-style-type: none"> • Dual Porosity & Dual Permeability Modeling • Dual Porosity and Dual Permeability Theory
?	<p>Note that some options are only available in some modules. For a detailed overview of the functionality available in each product, visit https://www.comsol.com/products/specifications/</p>

Unsaturated Dual Permeability Medium

Use the **Unsaturated Dual Permeability Medium** feature to model the transport in an unsaturated dual permeability medium where the Richards' Equation (Equation 7-6) describes the transport in each system.

$$\begin{aligned}
 \theta_M \left(\rho \left(S_{e,M} S_{p,M} + \frac{C_{m,M}}{\rho g} \right) \frac{\partial p_M}{\partial t} + \nabla(\rho \mathbf{u}_M) \right) &= -Q_{ip} + \theta_M Q_m \\
 (1 - \theta_M) \left(\rho \left(S_{e,m} S_{p,m} + \frac{C_{m,m}}{\rho g} \right) \frac{\partial p_m}{\partial t} + \nabla(\rho \mathbf{u}_m) \right) &= Q_{ip} + (1 - \theta_M) Q_m \\
 p &= \theta_M p_M + (1 - \theta_M) p_m
 \end{aligned} \tag{7-9}$$

θ_M is the volume fraction of the macropores, Q_{ip} is the interporosity flow which is the mass transfer from the macroscale to the microscale system. The indices **M** and **m** stand for macropores and micropores, respectively.

The feature has three default subfeatures—the **Fluid** subfeature where the fluid density ρ (SI unit: kg/m^3) and dynamic viscosity μ (SI unit: $\text{Pa}\cdot\text{s}$) are defined, the **Macropores** subfeature where the hydraulic properties of the macroporous matrix are defined, and the **Micropores** where the hydraulic properties of the microporous matrix are defined.

COORDINATE SYSTEM SELECTION

Select a coordinate system from the **Coordinate system** list for the interpretation of directions in anisotropic material properties. The default is the **Global coordinate system**, and the list contains any additional orthonormal coordinate system (except boundary coordinate systems) added under the **Definitions** node.

The subnodes inherit these coordinate system settings. In particular, the **Permeability** or **Hydraulic conductivity** (in the [Macropores](#) and [Micropores](#) subnodes) should be set according to the coordinate system selected in this section.

STORAGE MODEL

With this option, define the first term in [Equation 7-9](#). Therefore, choose from a drop-down menu one of the following formulations:

- From retention model
- Linearized storage (default)
- From liquid content
- User defined

If **From retention model** is chosen, the first term of [Equation 7-9](#) accounts only for the specific moisture capacity $C_{m,i}$ which is defined by the [Retention Model](#) in the [Macropores](#) (i=M) or [Micropores](#) (i=m) subnode:

$$\frac{C_{m,i} \partial p}{g \partial t}.$$

For the option **Linearized storage** the storage coefficient $S_{p,i}$ in [Equation 7-9](#) is defined as

$$S_{p,i} = \varepsilon_{p,i} \chi_f + (1 - \varepsilon_{p,i}) \chi_{p,i}.$$

From liquid content enforces the first term of [Equation 7-9](#) to be defined in terms of liquid volume fraction as

$$\frac{\partial(\rho \theta_{l,i})}{\partial t}$$

- and the **User defined** option allows to define the storage coefficient $S_{p,i}$ in [Equation 7-9](#) directly.



- [Storage Models](#) in the *Subsurface Flow Module User's Guide*
-

INTERPOROSITY FLOW

Specify the **Fluid Transfer Function** α_w which is used to calculate the interporosity flow, which is the mass exchange between macro- and microscale system:

$$Q_{ip} = \alpha_w(p_M - p_m) \quad (7-10)$$

with p_M being the pressure within the macroscale system and p_m the pressure within the microscale system.



- [Dual Porosity & Dual Permeability Modeling](#) in the *Subsurface Flow Module User's Guide*

Macropores

This node defines the porosity and material properties of the macroporous matrix of the [Dual Porosity Medium](#), the [Dual Permeability Medium](#), or the [Unsaturated Dual Permeability Medium](#) parent node.

MODEL INPUT

This section contains fields and values that are inputs for expressions defining material properties. If such user-defined property groups are added, the model inputs appear here.

VOLUME FRACTION

Here enter the **Volume Fraction of Macropores**, θ_M .

MATRIX PROPERTIES

The default **Porosity** $\varepsilon_{p,M}$ of the solid matrix of the macropore system is taken **From material**. Select **User defined** to enter a value or expression for $\varepsilon_{p,M}$.

If required by a **Storage model** in the parent node, specify the **Effective compressibility** of the porous matrix of the macropore system. The default value is $\chi_{p,M} = 10^{-4}$ 1/Pa.

Select a **Permeability model** to specify the capacity of the porous material to transmit flow. For the macropore settings only the Darcian Flow models are available. Select between the following options for the **Permeability model**:

- Select **Permeability** (default) to define the permeability of the porous matrix. The default **Permeability** κ_M (SI unit: m^2) uses the value **From material**, as defined by the **Porous material**. For **User defined** select **Isotropic** to define a scalar value or **Diagonal** or **Symmetric** to define a tensor value.
- Select **Hydraulic conductivity** or define a combination of fluid permeability and dynamic viscosity. For **Hydraulic conductivity** K_M (SI unit: m/s) select **Isotropic** to

define a scalar value or **Diagonal** or **Symmetric** to define a tensor value. The default is $2.94 \cdot 10^{-4}$ m/s.

- Select **Kozeny-Carman** to define the permeability from the porosity and mean particle diameter. Enter the mean **Particle diameter** $d_{p,M}$ (SI unit: m), the default value is 0.5 mm.

RETENTION MODEL

For an [Unsaturated Dual Permeability Medium](#) select between the following options for the retention model:

- **van Genuchten**, to specify the retention model using the van Genuchten relationship. Enter the constitutive relation constants α (the default value is 1, and the SI unit is 1/m), n (default value is 2), and l (default value is 0.5). The constitutive parameter m is equal to $1 - 1/n$.
- **Brooks and Corey** to use the retention model according to the Brooks and Corey relationships.
- **User defined** to use a different retention model. Enter user defined expressions for the **Effective saturation** $S_{e,M}$, the **Liquid volume fraction** $\theta_{l,M}$. The default is $\varepsilon_{p,M}$ (the porosity variable). Specify the **Specific moisture capacity** $C_{m,M}$ (SI unit: 1/m). The default value is 0 (1/m). Enter an expression for the **Relative permeability** $\kappa_{r,M}$. The default value is 1.

If there is a residual volume of liquid that cannot move through the pore network, also enter a value between 0 and 1 for the **Residual liquid volume fraction** θ_r . The default value is 0.



[Retention and Permeability Relationships](#) in the *Subsurface Flow Module User's Guide*

Micropores

This node defines the porosity and material properties of the microporous matrix of the [Dual Porosity Medium](#), [Dual Permeability Medium](#), or the [Unsaturated Dual Permeability Medium](#) parent node.

MODEL INPUT

This section is only available for the [Unsaturated Dual Permeability Medium](#) parent node and contains fields and values that are inputs for expressions defining material

properties. If such user-defined property groups are added, the model inputs appear here.

MATRIX PROPERTIES

The default **Porosity** $\epsilon_{p,m}$ of the solid matrix of the micropore system is taken **From material**. Select **User defined** to enter a value or expression for $\epsilon_{p,m}$.

If required by a **Storage model** in the parent node, specify the **Effective compressibility** of the microscale porous matrix. The default value is $\chi_{p,m} = 10^{-4}$ 1/Pa.

Select a **Permeability model** to specify the capacity to transmit flow for the porous material of the microscale system. Here, only the Darcian Flow models are available. Select between the following options for the **Permeability model**:

- Select **Permeability** (default) to define the permeability of the porous matrix. The default **Permeability** κ_m (SI unit: m^2) uses the value **From material**, as defined by the **Porous material**. For **User defined** select **Isotropic** to define a scalar value or **Diagonal** or **Symmetric** to define a tensor value.
- Select **Hydraulic conductivity** or define a combination of fluid permeability and dynamic viscosity. For **Hydraulic conductivity** K_m (SI unit: m/s) select **Isotropic** to define a scalar value or **Diagonal** or **Symmetric** to define a tensor value. The default is $2.94 \cdot 10^{-4}$ m/s.
- Select **Kozeny-Carman** to define the permeability from the porosity and mean particle diameter. Enter the mean **Particle diameter** $d_{p,m}$ (SI unit: m), the default value is 0.5 mm.

RETENTION MODEL

For an **Unsaturated Dual Permeability Medium** select between the following options for the retention model:

- **From macropores** to take over the retention model settings from the **Macropores** node.
- **van Genuchten**, to specify the retention model using the van Genuchten relationship. Enter the constitutive relation constants α (the default value is 1, and the SI unit is 1/m), n (default value is 2), and l (default value is 0.5). The constitutive parameter m is equal to $1 - 1/n$.
- **Brooks and Corey** to use the retention model according to the Brooks and Corey relationships.
- **User defined** to use a different retention model. Enter user defined expressions for the **Effective saturation** $S_{e,m}$, the **Liquid volume fraction** $\theta_{l,m}$. The default is $\epsilon_{p,m}$ (the

porosity variable). Specify the **Specific moisture capacity** $C_{m,m}$ (SI unit: 1/m). The default value is 0 (1/m). Enter an expression for the **Relative permeability** $\kappa_{r,m}$. The default value is 1.

If there is a residual volume of liquid that cannot move through the pore network, also enter a value between 0 and 1 for the **Residual liquid volume fraction** θ_r . The default value is 0.



Retention and Permeability Relationships in the *Subsurface Flow Module User's Guide*

INITIAL VALUES

Define the initial pressure of the microscale system. The default is to use the initial values defined in the **Initial Values** feature node which means that the same initial values apply to the macroscale and the microscale system.

Select **User Defined** to specify an initial pressure for the microscale system $p_{m0,init}$.



Note that some options are only available in some modules. For a detailed overview of the functionality available in each product, visit <https://www.comsol.com/products/specifications/>

Mass Source

The **Mass Source** node adds a mass source Q_m , which appears on the right-hand side of the Darcy's Law equation (Equation 7-3).

$$\frac{\partial}{\partial t}(\rho\varepsilon) + \nabla \cdot (\rho\mathbf{u}) = Q_m \quad (7-11)$$

For the Fracture Flow interface, the mass source is applicable to the right-hand side of Equation 4-40 in the *Subsurface Flow Module User's Guide* (where it is multiplied with the fracture thickness).

MASS SOURCE

Enter a value or expression for the **Mass source** Q_m (SI unit: kg/(m³·s)). The default is 0 kg/(m³·s).

Contributing Velocity

The **Contributing Velocity** node adds a velocity contribution \mathbf{u}_{ctrb} to the velocity field \mathbf{u}_d that is computed from the flow model selected in the parent **Porous Medium**, **Unsaturated Porous Medium**, or **Dual Porosity Medium** feature. The total velocity field used in the continuity equation is therefore

$$\mathbf{u} = \mathbf{u}_d + \mathbf{u}_{\text{ctrb}} \quad (7-12)$$

Such velocity contributions can arise in multiphysics models that involve, for example, transport of solutes. If several **Contributing Velocity** nodes are added under the same parent feature, the contributions are treated additively. The sum of all contributing velocity fields is available in the variables name `.Uctrb` (material frame) and `name.uctrb` (spatial frame), with `name` being the **Name** of the physics interface (for example, `d1`).

COORDINATE SYSTEM SELECTION

Select a coordinate system from the **Coordinate system** list to specify the coordinate system in which the contributing velocity field is given. The default is the **Global coordinate system**. Note that the coordinate system used to specify the components of the contributing velocity field can be selected independently of the coordinate system of the parent feature.

CONTRIBUTING VELOCITY

The default contributing velocity field \mathbf{u}_{ctrb} is **User defined**, which lets you enter the components of the contributing velocity field explicitly. If a matching velocity field is announced by another feature, it will be available in the selection list.

ADVANCED

Select the **Frame** in which the contributing velocity field is specified. The default is the **Reference configuration**, which means that the velocity field follows the material under, for example, a rotation of the domain. If instead your contributing velocity field follows a fixed direction in space, select the **Deformed configuration**. This section is only displayed if **Advanced Physics Options** is activated and the spatial and material frame of the component differ, such as in the presence of a **Moving Mesh** or **Solid Mechanics** interface.

Initial Values

The **Initial Values** node adds an initial value for the pressure that can serve as an initial condition for a transient simulation or as an initial guess for a nonlinear solver.

If you have the Subsurface Flow Module licensed, you can specify the pressure either directly or as an expression for the pressure head, H_p , or the hydraulic head, H ; the hydraulic head and the pressure head relate to the pressure p as

$$H_p = \frac{p}{\rho g}; \quad H = H_p + D$$

where ρ is the fluid density (SI unit: kg/m^3); g denotes the acceleration of gravity (SI unit: m/s^2); and D is the elevation (SI unit: m).

INITIAL VALUES

Enter a value or expression for the initial value of the **Pressure** p (SI unit: Pa). The default value is 0 Pa.

In case the Subsurface Flow Module is available, click the **Pressure head** button to enter a value or expression for H_p (SI unit: m). The default is 0 m. Click the **Hydraulic head** button to enter a value or expression for H (SI unit: m). The default is 0 m.

Gravity

The **Gravity** node is automatically added when **Include gravity** is selected at interface level in the **Darcy's Law** settings and it is active in all domains in which the Darcy's Law interface is applied.

COORDINATE SYSTEM SELECTION

The **Global coordinate system** is selected by default. The **Coordinate system** list contains any additional coordinate systems that the model includes. It can be used when prescribing the direction of the gravitational forces.

GRAVITY

Specify either the acceleration vector or — in case you have a Subsurface Flow Module license — the elevation.

When **Acceleration** is selected from the list, enter the components of the **Gravity vector** \mathbf{g} . The default value is $\mathbf{g_const}$ which is the physical constant having the value 9.8066 m/s^2 .

- For 3D and 2D axisymmetric models, the default value is $-\mathbf{g_const}$ in the z direction.
- For 2D models, the default value is $-\mathbf{g_const}$ in the y direction.

When **Elevation** is selected from the list, specify the **Elevation** D (SI unit: m). The **Acceleration of gravity** is taken **From physics interface** by default but could be overridden when **User defined** is selected.

When the check box **Include gravity** is not selected in the Darcy's Law interface Settings, the elevation D is set equal to zero.

Select the check box **Specify reference position** to define a reference position for the gravity calculation.

Cross Section

Use this node with 1D components to model domains with another cross-sectional area than the global one that is used in the interface **Physical Model** section. In 1D geometries, the pressure is assumed to be constant in the radial direction, and Darcy's Law accounts for that.

CROSS SECTION

Enter values for the **Cross-sectional area** A_c to set the cross section of the domain in the plane perpendicular to the 1D geometry.

Thickness

Use this node with 2D and 1D axisymmetric components to model domains with another thickness than the overall thickness that is specified in the interface **Physical Model** section. In 2D geometries, the pressure is assumed to be constant in the out-of-plane direction (the z direction with default spatial coordinate names). In 1D axisymmetric geometries the thickness represents the z direction.

THICKNESS

Specify a value for the **Thickness** d_z of the domain in the out-of-plane direction. This value replaces the overall thickness in the domains that are selected in the **Domain Selection** section, and is used to multiply some terms into the heat equation.

Porous Electrode Coupling

Use the **Porous Electrode Coupling** node to define a mass source based on the volumetric current densities of one or multiple **Porous Electrode Reaction** nodes in an Electrochemistry interface.

The source (or sink) is proportional to the **Molar mass (kg/mol)** of the reacting species, the current densities and the stoichiometric coefficients according to Faraday's law as defined by summation over the Reaction Coefficient subnodes.

SPECIES

Based on the number of species required for the model, use the **Add** (+) and **Delete** () buttons under the table to add or remove **Species**. Then enter a value for the **Molar mass (kg/mol)** in the applicable rows for each species.

The setting in the table will determine the number of available fields for entering the stoichiometric coefficients of the Reaction Coefficient subnodes.

Electrode Surface Coupling

Use the **Electrode Surface Coupling** node to define a combined wall and inflow/outflow boundary condition based on current densities of one or multiple Electrode Reaction nodes in an Electrochemistry interface.

The flow is proportional to the **Molar mass (kg/mol)** of the reacting species, the current densities and the stoichiometric coefficients according to Faraday's law as defined by summation over the Reaction Coefficient subnodes.

SPECIES

Based on the number of species required for the model, use the **Add** (+) and **Delete** () buttons under the table to add or remove **Species**. Then enter a value for the **Molar mass (kg/mol)** in the applicable rows for each species.

The setting in the table will determine the number of available field for entering the stoichiometric coefficients of the Reaction Coefficient subnodes.

Pressure

Use the **Pressure** node to specify the pressure on a boundary. In many cases the distribution of pressure is known, giving a Dirichlet condition $p = p_0$ where p_0 is a

known pressure given as a number, a distribution, or an expression involving time, t , for example.

PRESSURE

Enter a value or expression for the **Pressure** p_0 (SI unit: Pa). Enter a relative pressure value in p_0 (SI unit: Pa).

For the Subsurface Flow Module, the **Pressure** node provides the pressure P_0 as a condition on edges in 3D models. Then select the edges under **Edge Selection**.

CONSTRAINT SETTINGS

To display this section, click the **Show More Options** button () and select **Advanced Physics Options** in the **Show More Options** dialog box.

As an attribute to the [Fracture](#) boundary condition or as boundary condition to [The Fracture Flow Interface](#) (which are available in the Subsurface Flow Module and the Porous Media Flow Module), the pressure can also be specified on edges (in 3D) or points (in 2D) surrounding the fracture domain. In other cases, pressure constraints on edges or points are not implemented.



If the boundary condition is adjacent to an [Unsaturated Dual Permeability Medium](#) feature it constrains the pressures in the [Macropores](#) and [Micropores](#) to p_0 .

Mass Flux

Use the **Mass Flux** node to specify the mass flux into or out of the model domain through some of its boundaries. It is often possible to determine the mass flux from the pumping rate or from measurements. With this boundary condition, positive values correspond to flow into the model domain:

$$\mathbf{n} \cdot \rho \frac{k}{\mu} (\nabla p + \rho g \nabla D) = N_0$$

where N_0 is a value or expression for the specified inward (or outward) Darcy flux. D is the elevation head which is set to zero for other than Subsurface Flow Module applications.

MASS FLUX

Enter a value or expression for the **Inward mass flux** N_0 . A positive value of N_0 represents an inward mass flux whereas a negative value represents an outward mass flux. The units are based on the geometric entity: **Boundaries**: (SI unit: $\text{kg}/(\text{m}^2\cdot\text{s})$).

Line Mass Source

The **Line Mass Source** node adds mass flow originating from a tube of infinitely small radius.

SELECTION

The **Line Mass Source** feature is available for all dimensions, but the applicable selection differs between the dimensions.

MODEL DIMENSION	APPLICABLE GEOMETRICAL ENTITY
2D	Points
2D Axisymmetry	Points not on the symmetry axis
3D	Edges

LINE MASS SOURCE

Enter a value or expression for the source strength, N_0 (SI unit: $\text{kg}/(\text{m}\cdot\text{s})$). A positive value results in mass injection from the line into the computational domain, and a negative value means that the mass is removed from the computational domain.

Line sources located on a boundary affect the adjacent computational domains. This effect makes the physical strength of a line source located in a symmetry plane twice the given strength.

Fracture Flow

The equivalent feature available for fracture flow is the **Mass Source** attribute of the [Fracture](#) boundary condition and the **Mass Source** point feature of the Fracture Flow Interface, both available in 3D only.

Point Mass Source

The **Point Mass Source** node models mass flow originating from an infinitely small sphere centered around a point. It is available for points in 3D geometries.

POINT MASS SOURCE

Enter a value or expression for the source strength, N_0 (SI unit: kg/(s)). A positive value results in mass injection from the point into the computational domain, and a negative value means that the mass is removed from the computational domain.

Point sources located on a boundary or on an edge affect the adjacent computational domains. This has the effect, for example, that the physical strength of a point source located in a symmetry plane is twice the given strength.

Inlet

The **Inlet** node adds a boundary condition for the inflow (or outflow) perpendicular (normal) to the boundary. It has three options that can be used to specify inlet condition on a boundary, as follows:

VELOCITY

Enter a value or expression for the **Normal inflow velocity** U_0 (SI unit: m/s). A positive value of U_0 represents an inflow velocity. A negative value represents an outflow velocity. The inlet velocity boundary condition is implemented as;

$$\mathbf{n} \cdot \rho \frac{\kappa}{\mu} (\nabla p + \rho g \nabla D) = \rho U_0$$

where U_0 is a value or expression for the specified inward (or outward) Darcy velocity. A positive value of the velocity U_0 corresponds to flow into the model domain whereas a negative value represents an outflow. D is the elevation head which is set to zero for other than Subsurface Flow Module applications.

PRESSURE

Use the **Pressure** option to specify the inlet pressure on a boundary. In many cases the distribution of pressure is known, giving a Dirichlet condition $p = p_0$ where p_0 is a known pressure given as a number, a distribution, or an expression involving time, t , for example. Enter a value or expression for the **Pressure** p_0 (SI unit: Pa).

MASS FLOW

If you select **Mass flow** as the inlet condition, specify the total **Mass flow rate** M_0 (SI unit: kg/s), or the **Pointwise mass flux** N_0 (SI unit: kg/(m²·s)).

With **Mass flow rate** boundary condition, positive values correspond to flow into the model domain:

$$-\int_{\partial\Omega} \rho(\mathbf{u} \cdot \mathbf{n})dS = M_0$$

where M_0 is a value or expression for the specified inward (or outward) Darcy flux.

Pointwise mass flux boundary condition, positive values correspond to flow into the model domain:

$$\mathbf{n} \cdot \rho \frac{\kappa}{\mu} (\nabla p + \rho g \nabla D) = N_0$$

where N_0 is a value or expression for the specified inward (or outward) Darcy flux.

CONSTRAINT SETTINGS

To display this section, click the **Show More Options** button () and select **Advanced Physics Options** in the **Show More Options** dialog box.

Symmetry

The **Symmetry** node describes a symmetry boundary. The following condition implements the symmetry condition on an axis or a flow divide:

$$\mathbf{n} \cdot \frac{\kappa}{\mu} \nabla p = 0$$

$$\mathbf{n} \cdot \frac{\kappa}{\mu} (\nabla p + \rho g \nabla D) = 0$$

For axisymmetric components, COMSOL Multiphysics takes the axial symmetry boundaries (at $r = 0$) into account and automatically adds an **Axial Symmetry** node that is valid on the axial symmetry boundaries only.

No Flow

The **No Flow** node is the default boundary condition stating that there is no flow across impermeable boundaries. The mathematical formulation is:

$$\mathbf{n} \cdot \rho \frac{\kappa}{\mu} (\nabla p + \rho g \nabla D) = 0$$

where \mathbf{n} is the vector normal to the boundary. D is the elevation head which is set to zero for any other than Subsurface Flow Module applications.

Flux Discontinuity

Use the **Flux Discontinuity** node to specify a mass flux discontinuity through an interior boundary. The condition is represented by the following equation:

$$-\mathbf{n} \cdot (\rho \mathbf{u}_1 - \rho \mathbf{u}_2) = N_0$$

In this equation, \mathbf{n} is the vector normal (perpendicular) to the interior boundary, ρ is the fluid density, \mathbf{u}_1 and \mathbf{u}_2 are the Darcy velocities in the adjacent domains (as defined in Equation 7-13) and N_0 is a specified value or expression for the flux discontinuity.

$$\mathbf{u} = -\frac{\kappa}{\mu} \nabla p \quad (7-13)$$

For this boundary condition, a positive value of N_0 corresponds to a flow discontinuity in the opposite direction to the normal vector of the interior boundary.

MASS FLUX

Enter a value or expression for the **Inward mass flux** N_0 (SI unit: kg/(m²·s)). A positive value of N_0 represents a mass flux discontinuity in the opposite direction to the normal vector of the interior boundary.

Outlet

The **Outlet** node adds a boundary condition for the outflow (or inflow) perpendicular (normal) to the boundary. It has different options that can be used to specify inlet condition on a boundary, as follows:

VELOCITY

Enter a value or expression for the **Normal outflow velocity** U_0 (SI unit: m/s). A positive value of U_0 represents an outflow velocity whereas a negative value represents an inflow velocity.

$$-\mathbf{n} \cdot \rho \frac{\kappa}{\mu} \nabla p = \rho U_0$$

where U_0 is a specified value or expression for the outward (or inward) Darcy velocity.

PRESSURE

Similar to the inlet **Pressure** option, the outlet pressure on a boundary can be specified. Enter a value or expression for the **Pressure** p_0 (SI unit: Pa).

DISCHARGE

Enter a value or expression for the discharge Q_D to specify the volumetric flow rate through the boundary. The mass flux $\rho \mathbf{u}$ is related to the discharge as follows:

$$\int_{\partial\Omega} \rho \mathbf{u} \cdot \mathbf{ds} = \rho Q_D. \quad (7-14)$$

The mean normal outflow velocity at the boundary can then be calculated as $U_{\text{out}} = Q_D/A$, where A is the cross sectional area of the boundary.

Precipitation

Enter a value or expression for the **Precipitation rate** which then contributes to the mass flux at the boundaries selected. If the boundary is inclined, a **Slope correction** can be applied.

Interior Wall

The **Interior Wall** boundary condition can only be applied on interior boundaries. It is similar to the **No Flux** boundary available on exterior boundaries except that it applies on both sides of an interior boundary. It allows discontinuities of velocity and pressure across the boundary. The **Interior Wall** boundary condition can be used to avoid meshing thin structures by applying no-flux condition on interior curves and surfaces instead.

Thin Barrier

The **Thin Barrier** boundary condition models interior permeable walls, membranes, geotextiles, or perforated plates as thin permeable barriers. The **Thin Barrier** boundary condition can only be applied on interior boundaries.

WALL

Enter a value or expression for the **Thickness** d_b (SI unit: m, the default is 0.1 m) and for the **Permeability** κ_b (SI unit: m^2). The default **Permeability** κ_b uses the value **From material**. For **User defined** select **Isotropic** to define a scalar value or **Diagonal, Symmetric**, or **Full** to define a tensor value and enter another value or expression in the field or matrix.

Pressure Head

Use the **Pressure Head** node to specify the pressure head (instead of the pressure) on a boundary. It adds this boundary condition for the pressure head $H_p = H_{p0}$, where H_{p0} is a known pressure head given as a number, a distribution, or an expression involving time, t , for example. The dimension of the pressure head is length (SI unit: m).

PRESSURE HEAD

Enter a value or expression for the **Pressure head** H_{p0} (SI unit: m). The default is 0 m.

CONSTRAINT SETTINGS

To display this section, click the **Show More Options** button () and select **Advanced Physics Options** in the **Show More Options** dialog box.

Hydraulic Head

Use the **Hydraulic Head** node to specify the hydraulic head (instead of the pressure) on a boundary. This adds the Dirichlet condition for the hydraulic head $H = H_0$ where H_0 is a known hydraulic head given as a number, a distribution, or an expression involving time, t , for example.

HYDRAULIC HEAD

Enter a value or expression for the **Hydraulic head** H_0 (SI unit: m). The default is 0 m.

CONSTRAINT SETTINGS

To display this section, click the **Show More Options** button () and select **Advanced Physics Options** in the **Show More Options** dialog box.

Atmosphere/Gauge

The **Atmosphere/Gauge** node specifies an atmospheric pressure or gauges the pressure to the atmospheric value. This means that the total hydraulic potential reduces to the gravitational pressure at the free surface. At a free surface, such as a spring or a seepage face, the pressure is atmospheric. If the pressures in the model is gauged to the atmospheric value ($p = 0$), the total hydraulic potential reduces to the gravitational potential at the free surface — for example, the height of the free surface multiplied by the fluid weight, or $\rho_f g D$. This boundary condition sets the pressure at the boundary to zero and $p = 0$.

CONSTRAINT SETTINGS

To display this section, click the **Show More Options** button () and select **Advanced Physics Options** in the **Show More Options** dialog box.

Pervious Layer

The **Pervious Layer** node provides a boundary condition that describes a mass flux through a semi-pervious layer connected to an external fluid source at different pressure, pressure head, or hydraulic head. The model domain might connect to a larger body of water through the semi-pervious layer. This condition is represented with the following boundary condition:

$$\mathbf{n} \cdot \rho \frac{K}{\mu} (\nabla p + \rho g \nabla D) = \rho R_b \left[\frac{(p_b - p)}{\rho g} + (D_b - D) \right] \quad (7-15)$$

In this equation, p_b (SI unit: Pa) and D_b (SI unit: m) are the pressure and the elevation of the distant fluid source, respectively, and R_b (SI unit: 1/s) is the conductance of materials between the source and the model domain (conductance to flow in the semi-pervious layer adjacent to the boundary). Typically $R_b = K'/B'$, where K' is the hydraulic conductivity (SI unit: m/s) of the layer and B' (SI unit: m) is its thickness. Using logical relationships, it is possible to activate these expressions at different times or under various flow conditions.

When the pressure head H_p is specified instead of the pressure, the boundary condition is the following:

$$\mathbf{n} \cdot \rho K \nabla (H_p + D) = \rho R_b [(H_{pb} - H_p) + (D_b - D)] \quad (7-16)$$

H_{pb} is the pressure head (SI unit: m) at the edge of the layer.

When the hydraulic head H is specified instead of the pressure head, the boundary condition becomes:

$$\mathbf{n} \cdot \rho K \nabla H = \rho R_b [H_b - H] \quad (7-17)$$

H_b is the hydraulic head (SI unit: m) at the edge of the layer.

K in [Equation 7-16](#) and [Equation 7-17](#) is the hydraulic conductivity.

At a free surface, such as a water table or seepage face, the pressure is atmospheric (here taken to be zero), so the total hydraulic potential equals gravitational potential, which is defined on D .



Gravity effects are not active by default. Select the check box **Include gravity** to activate the acceleration of gravity. Setting the elevation D to zero also turns off gravity effects.

PERVIOUS LAYER

Specify the material properties whether to specify an external pressure, pressure head, or hydraulic head.

Select an **External variable to specify** — **Pressure and elevation** to specify the external pressure, **Pressure head and elevation** to specify the external pressure head, or **Hydraulic head**. For all selections, enter a value for the **Conductance** R_b (SI unit: 1/s).

- For **Pressure and elevation** enter an **External pressure** p_b (SI unit: Pa) and **External elevation** D_b (SI unit: m).
- For **Pressure head and elevation** enter an **External pressure head** H_{pb} (SI unit: m), H_{pb} (SI unit: m) and **External elevation** D_b (SI unit: m).
- For **Hydraulic head** enter the **Hydraulic head** H_b (SI unit: m).

Well

The **Well** feature is intended to model injection or production wells and is available with the Subsurface Flow Module.

WELL

Enter a value or expression for the **Well diameter** d_w (SI unit: m, the default is 0.1 m). Select the **Well type** from the list: **Production** or **Injection**.

Specify either the **Pressure** (SI unit: Pa), **Pressure head** (SI unit: m), **Hydraulic head** (SI unit: m), or the **Mass flow**. If you select **Mass flow**, specify the total **Mass flow rate** (SI unit: kg/s), the **Mass flow rate per unit length** (SI unit: kg/(m·s)) or the **Mass flux** (SI unit: kg/(m²·s)).

Fracture

Use the **Fracture** node to model flow along a boundaries representing fractures within a porous medium. By default, it adds the tangential form of the continuity equation and of Darcy's Law.

$$d_f \frac{\partial}{\partial t} (\epsilon_p \rho) + \nabla_T \cdot (d_f \rho \mathbf{u}) = d_f Q_m \quad (7-18)$$

$$\mathbf{u} = -\frac{\kappa}{\mu} \nabla_T p \quad (7-19)$$

The **Fracture** feature has two default subfeatures — the **Fluid (Fracture)** subfeature where the fluid density ρ (SI unit: kg/m^3) and dynamic viscosity μ (SI unit: $\text{Pa}\cdot\text{s}$) are defined and the **Fracture Material** subfeature where the permeability κ (SI unit: m^2) and porosity ϵ_p (dimensionless) are specified.

COORDINATE SYSTEM SELECTION

Select a coordinate system from the **Coordinate system** list for the interpretation of directions in anisotropic material properties. The default is the **Global coordinate system**, and the list contains any additional orthonormal coordinate system (except boundary coordinate systems) added under the **Definitions** node.

The subnodes inherit these coordinate system settings. In particular, the **Permeability** or **Hydraulic conductivity** (in the **Fracture Material** subnode) should be set according to the coordinate system selected in this section.

APERTURE

Enter a value for the **Fracture thickness** d_f .

FLOW MODEL

Define if the flow follows a linear or nonlinear pressure-velocity relationship.

- **Darcian flow** (default) defines a linear relationship using [Equation 7-18](#) and [Equation 7-19](#).
- **Non-Darcian flow** defines a nonlinear relationship using [Equation 7-18](#) and the pressure-velocity relationship

$$\nabla_T p = -\frac{\mu}{\kappa} \mathbf{u} - \beta \rho |\mathbf{u}| \mathbf{u}$$

where the nonlinear parameter β (SI unit: 1/m) is further specified in the [Fracture Material](#) subfeature.

STORAGE MODEL

[Equation 7-18](#) can also be formulated with respect to a storage term.

$$\rho S \frac{\partial p}{\partial t} + \nabla \cdot \rho \left[-\frac{\kappa}{\mu} (\nabla p) \right] = Q_m$$

The storage coefficient S can be interpreted as the weighted compressibility of the porous material and the fluid. Define the time dependent storage term by selecting one of the following options from the drop-down menu:

- **From density and porosity** (default), uses the formulation of [Equation 7-18](#)
- **Linearized storage**, where the following linear equation is used to define the storage:

$$S = \varepsilon_p \chi_f + (1 - \varepsilon_p) \chi_p$$

- **User defined** to directly specify the storage coefficient S



- [About Darcian and Non-Darcian Flow](#) in the *Porous Media Flow Module User's Guide*
- [Storage Models](#) in the *Subsurface Flow Module User's Guide*

FRACTURE MODEL

Choose between two options to model fractures that have different characteristics.

- **Highly conductive fracture** represents a fracture filled with a highly permeable material.
- **Thin conducting barrier** represents a fracture that is filled with a low permeable material and therefore acts as a barrier for the flow which adds a jump in the pressure across the boundary:

$$-\mathbf{n}_{u,d} \cdot (\rho \mathbf{u})_{u,d} = \rho \frac{(P_{d,u} - P_{u,d}) \kappa_b}{d_b \mu}$$

The barrier thickness d_b and permeability κ_b are defined in the [Fracture Material](#) subnode.

In addition, either on the upside, downside, or on both sides a highly conductive fracture material is present and [Equation 7-18](#) and [Equation 7-19](#) are solved for the highly conductive side. Further specifications are done in the [Fracture Material](#) subnode.



Note that the option to specify the **Fracture Model** is only available for the Fracture feature within the Darcy's Law interface.

For the [Fracture](#) boundary node several subnodes are available from the context menu (right-click the parent node) or from the **Physics** toolbar, **Attributes** menu. As they are almost identical to the boundary conditions of the Fracture Flow interface, see [Domain, Boundary, Edge, Point, and Pair Nodes for the Fracture Flow Interface](#) in the *Subsurface Flow User's Guide* for further description. Note that **Precipitation** is only available for the Fracture Flow interface.



This feature requires a specific license. For a detailed overview of the functionality available in each product, visit <https://www.comsol.com/products/specifications/>.



Flow in a Fractured Reservoir: Application Library path
Subsurface_Flow_Module/Fluid_Flow/fractured_reservoir_flow

Fluid (Fracture)

This node defines the material properties of the fluid of the [Fracture](#) parent node. The fluid can be specified as general gas or liquid or as an ideal gas.

MODEL INPUT

This section contains fields and values that are inputs for expressions defining material properties. If such user-defined property groups are added, the model inputs appear here.

FLUID PROPERTIES

The available options for the **Fluid type** are **Gas/Liquid** (default) or **Ideal gas**. The selection determines how the density and compressibility of the fluid are set. The latter is only required if a linearized storage model has been selected in the parent [Fracture](#) node. For all fluid types specify the dynamic viscosity μ (SI unit: Pa·s).

Gas/Liquid

This option specifies the **Density** and the **Compressibility** for a general gas or liquid.

Ideal Gas

For **Ideal gas** it uses the ideal gas law to describe the fluid. In this case, specify the thermodynamics properties. Select a **Gas constant type** — **Specific gas constant** R_s (the default) or **Mean molar mass** M_n (SI unit: J/(mol·K)). For **Mean molar mass** the universal gas constant $R = 8.314$ J/(mol·K) is used as the built-in physical constant. For both properties, the defaults use values **From material**. For **User defined** enter another value or expression.

If required by a **Storage Model**, the **Compressibility** of the ideal gas is calculated as $\chi_f = 1/p_A$ with the absolute pressure p_A (Pa).



If **Hydraulic conductivity** is selected as the **Permeability model** (see the [Fracture Material](#) section), dynamic viscosity is not available. The hydraulic conductivity is defined using a combination of fluid and fracture material properties and replaces the need of defining the dynamic viscosity.

Fracture Material

This node defines the porosity and material properties of the solid matrix of the [Fracture](#) parent node.

MODEL INPUT

This section contains fields and values that are inputs for expressions defining material properties. If such user-defined property groups are added, the model inputs appear here.

BARRIER PROPERTIES

This section appears if the **Thin conducting barrier** option for the **Fracture model** is chosen in the parent [Fracture](#) feature.

Enter the values for the barrier thickness d_b and permeability κ_b .

Note that the **Thin Conductive barrier** option is only available for the Fracture feature within the Darcy's Law interface.

FRACTURE MATERIAL PROPERTIES

If the **Thin conducting barrier** option for the **Fracture model** is chosen in the parent **Fracture** feature you can specify the **Conductive layer position** here. Choose between **Both sides**, **Upside**, and **Downside**. A sketch above shows the position of conductive layers and barrier within the fracture.

The **Porosity** ε_p of the fracture material is taken **From material** by default. Select **User defined** to enter a value or expression for ε_p .

If required by a **Storage model** in the parent node, specify the **Effective compressibility** of the porous matrix. The default value is $\chi_p = 10^{-4}$ 1/Pa.

Select a **Permeability model** to specify the capacity of the fracture material to transmit flow. Which options are available depends on the **Flow model** setting in the parent node.



- Select **Permeability** (default) to define the permeability of the fracture material.
- Select **Hydraulic conductivity** or define a combination of fluid permeability and dynamic viscosity. For **Hydraulic conductivity** K (SI unit: m/s) select **Isotropic** to define a scalar value or **Diagonal** or **Symmetric** to define a tensor value. The default is $2.94 \cdot 10^{-4}$ m/s.
- Select **Cubic law** to define the permeability from the fracture thickness specified in the parent node and the roughness factor f_f .

If the Non-Darcian Flow Model is selected in the parent **Fracture** feature enter a value for the **Inertial resistance coefficient** β .



- [About Darcian and Non-Darcian Flow](#) in the *Porous Media Flow Module User's Guide*
 - [Permeability Models](#) in the *Porous Media Flow Module User's Guide*
-

The Free and Porous Media Flow, Brinkman Interface

The **Free and Porous Media Flow, Brinkman (fp)** interface () is found under the **Porous Media and Subsurface Flow** branch () when adding a physics interface. It is used to compute fluid velocity and pressure fields of single-phase flow where free flow is connected to porous media. The Free and Porous Media Flow, Brinkman interface is used over at least two different domains: a free channel and a porous medium. The physics interface is well suited for transitions between slow flow in porous media, governed by the Brinkman equations, and fast flow in channels described by the Navier–Stokes equations. Fluids with varying density can be included at Mach numbers below 0.3. Also the viscosity of a fluid can vary, for example, to describe non-Newtonian fluids. The physics interface can be used for stationary and time-dependent analyses.

When this physics interface is added, the following default nodes are also added in the **Model Builder** — **Fluid Properties**, **Wall**, and **Initial Values**. Then, from the **Physics** toolbar, add a **Porous Medium** node to be used on the domain selection corresponding to the porous media, or add other nodes that implement, for example, boundary conditions and volume forces. You can also right-click **Free and Porous Media Flow, Brinkman** to select physics features from the context menu.

SETTINGS

The **Label** is the default physics interface name.

The **Name** is used primarily as a scope prefix for variables defined by the physics interface. Refer to such physics interface variables in expressions using the pattern `<name>.<variable_name>`. In order to distinguish between variables belonging to different physics interfaces, the `name` string must be unique. Only letters, numbers, and underscores (`_`) are permitted in the **Name** field. The first character must be a letter.

The default **Name** (for the first physics interface in the model) is `fp`.

PHYSICAL MODEL

Compressibility

By default the physics interface uses the **Incompressible flow** formulation of the Navier–Stokes and Brinkman equations to model constant density flow. If required, select

Weakly compressible flow from the **Compressibility** list, to account for small variations in the density, which are only dependent on the temperature (nonisothermal flow) or **Compressible flow (Ma<0.3)** for fully compressible flow. However, for the flow modeled with this physics interface, the Mach number must be below 0.3.

Swirl Flow

For 2D axisymmetric components, select the **Swirl flow** check box to include the swirl velocity component, that is the velocity component u_ϕ in the azimuthal direction. While u_ϕ can be nonzero, there can be no gradients in the ϕ direction. Note that this feature is only available for specific modules. Visit <https://www.comsol.com/products/specifications/> for a detailed overview.

Neglect Inertial Term

Select the **Neglect inertial term (Stokes flow)** check box if the inertial forces are small compared to the viscous forces.

Enable porous media domains

The **Enable porous media domains** check box is selected by default to solve the Brinkman equations in porous domains. If it is unchecked, the **Porous Medium** node is no longer available in this interface.

Include Gravity

Gravity is not included by default. Select the **Include gravity** check box to activate the acceleration of gravity. This automatically adds a global **Gravity** feature node to the interface model tree, and the buoyancy force is included in the Equations.

Also, when the **Include gravity** check box is selected, the **Use reduced pressure** option changes the pressure formulation from using the total pressure (default) to using the reduced pressure. This option is suitable for configurations where the density changes are very small; otherwise, the default formulation can be used. For more information, see [Gravity](#).

Porous Treatment of No Slip Condition

Choose how the **No Slip** condition on internal boundaries should be treated. The options are **Standard no slip formulation** and **Porous slip** (default). The latter option provides a unified treatment when the porous matrix is fully resolved as well as when it is under resolved ensuring a smooth transition between regions with different resolutions; see No Slip under **Wall** in the [The Laminar Flow and Creeping Flow Interfaces](#) section.

Reference Pressure Level

Enter a **Reference pressure level** p_{ref} (SI unit: Pa). The default value is 1 [atm].

Reference Temperature

Enter a **Reference temperature** T_{ref} (SI unit: K). The default value is 293.15 [K].

Reference Position

If **Include gravity** is selected, a **Reference position** r_{ref} (SI unit: m) can be specified which is then used for the calculation of the hydrostatic pressure.

TURBULENCE

Turbulent flow can be simulated by changing the **Turbulence model type** to **RANS** (Reynolds-Averaged Navier–Stokes) or **Large Eddy Simulation** (which is only available in 3D). If turbulent flow is activated, you can choose from different **Turbulence models** and options for **Wall treatment**. For a description of the different turbulence models, wall treatment options, and turbulence model parameters see [Theory for the Turbulent Flow Interfaces](#) in the *CFD Module User's Guide*.

DEPENDENT VARIABLES

The following dependent variables (fields) are defined for this physics interface — the **Velocity field** \mathbf{u} (SI unit: m/s) and its components, and the **Pressure** p (SI unit: Pa).



- [Domain, Boundary, Point, and Pair Nodes for the Free and Porous Media Flow, Brinkman Interface](#)
 - [Theory for the Free and Porous Media Flow, Brinkman Interface](#)
-

Domain, Boundary, Point, and Pair Nodes for the Free and Porous Media Flow, Brinkman Interface

[The Free and Porous Media Flow, Brinkman Interface](#) has the following domain, boundary, point, and pair nodes, listed in alphabetical order, available from the **Physics** ribbon toolbar (Windows users), **Physics** context menu (Mac or Linux users), or right-click to access the context menu (all users).



In general, to add a node, go to the **Physics** toolbar, no matter what operating system you are using. Subnodes are available by clicking the parent node and selecting it from the **Attributes** menu.

- Electrode Surface Coupling
- Fluid Properties
- Gravity
- Initial Values
- Porous Medium
- Mass Source
- Volume Force
- Wall

Note that some features are only available with certain COMSOL products (see <https://www.comsol.com/products/specifications/>).



See the Transport of Diluted Species interface for [Porous Electrode Coupling](#) and [Reaction Coefficients](#).

The following nodes (listed in alphabetical order) are described for the Laminar Flow interface in the *COMSOL Multiphysics Reference Manual*:

- No Viscous Stress
- Flow Continuity
- Inlet
- Line Mass Source
- Outlet
- Open Boundary
- Periodic Flow Condition
- Point Mass Source
- Pressure Point Constraint
- Symmetry



In the *COMSOL Multiphysics Reference Manual* see [Table 2-4](#) for links to common sections and [Table 2-5](#) to common feature nodes. You can also search for information: press F1 to open the **Help** window or Ctrl+F1 to open the **Documentation** window.

Fluid Properties

Use the **Fluid Properties** node to define the fluid material, density, and dynamic viscosity.

FLUID PROPERTIES

The default **Fluid material** uses the **Domain material** (the material defined for the domain). Select another material as needed.

The default **Density** ρ (SI unit: kg/m^3) uses values **From material** based on the **Fluid material** selection. For **User defined** enter another value or expression. The default is $0 \text{ kg}/\text{m}^3$.

The **Dynamic viscosity** μ (SI unit: Pa·s) uses values **From material** based on the **Fluid material** selection. For **User defined** enter another value or expression. The default is $0 \text{ Pa}\cdot\text{s}$.

Porous Medium

The **Porous Medium** node adds the Brinkman equations (excluding any mass sources) to the interface. It has two default subfeatures — the **Fluid** subfeature where the fluid density ρ (SI unit: kg/m^3) and dynamic viscosity μ (SI unit: Pa·s) are defined and the **Porous Matrix** subfeature where the permeability κ (SI unit: m^2) and porosity ε_p (dimensionless) are specified.

FLOW MODEL

Define if the flow follows a linear or nonlinear pressure-velocity relationship.

- **Darcian flow** (default) defines a linear relationship characteristic for low Reynolds number laminar flows.
- **Non-Darcian flow** defines a nonlinear relationship due to inertial or turbulence effects.

POROUS MEDIUM TURBULENCE MODEL

Defines a model which complements the basic turbulence model and accounts for the influence of the porous matrix on turbulent flow in Porous Media.

- **Default** and **Nakayama-Kuwahara** specify **Coefficient of subgrid turbulence generation by porous matrix** C_{stpm} which by default is set to 0.212.
- **Pedras-de Lemos** asks to specify **Choice of the Pedras-de Lemos model coefficient**. When **User defined** is chosen, specify **Coefficient of subgrid turbulence generation by porous matrix** C_{stpm} with default value 0.212. Choosing **Original** results in $C_{\text{stpm}} = 0.28 \cdot \sqrt{\varepsilon_p}$, while choosing **Recalibrated** results in $C_{\text{stpm}} = 0.18$.

Fluid

This node defines the material properties of the fluid of the **Porous Medium** parent node.

MODEL INPUT

This section contains fields and values that are inputs for expressions defining material properties. If such user-defined property groups are added, the model inputs appear here.

FLUID PROPERTIES

Specify the **Density** ρ and the **Dynamic viscosity** μ (SI unit: Pa·s) of the fluid. The defaults use values **From material**, for **User defined** enter a value or expression.

The dynamic viscosity describes the relationship between the shear stresses and the shear rate in a fluid. Intuitively, water and air have a low viscosity, and substances often described as thick, such as oil, have a higher viscosity.

Porous Matrix

This node defines the porosity and material properties of the solid matrix of the **Porous Medium** parent node.

MODEL INPUT

This section contains fields and values that are inputs for expressions defining material properties. If such user-defined property groups are added, the model inputs appear here.

MATRIX PROPERTIES

The **Porosity** ε_p (a dimensionless number between 0 and 1) uses by default the value **From material**. For **User defined** the default value is 1 which is equivalent to free flow.

Select a **Permeability model** to specify the capacity of the porous material to transmit flow. Depending on the **Flow model** selection in the parent **Porous Medium** feature node you can choose between the following options:

- **Permeability** (the default) to directly enter the permeability of the porous matrix or **Kozeny-Carman** to define the permeability from the porosity and mean **Particle diameter** for **Darcian** flow or
- **Forchheimer** or **Ergun** for **Non-Darcian** flow.

Note that some of these options are only available for certain modules. For a detailed overview of the functionality available in each product, visit <https://www.comsol.com/products/specifications/>.

The default **Permeability** κ (SI unit: m^2) uses the value **From material**, as defined by the **Porous material** list. For **User defined** select **Isotropic** to define a scalar value or **Diagonal** or **Symmetric** to define a tensor value.

For **Kozeny-Carman**, enter the mean **Particle diameter** d_p (SI unit: m), the default value is 0.5 mm.

In case a **Non-Darcian** flow model is chosen in the parent node, **Forchheimer** is the default selection for the **Permeability model**. For **Forchheimer**, the default **Permeability** κ (SI unit: m^2) uses the value **From material**. Furthermore, the dimensionless **Forchheimer parameter** c_F can be defined. The default value is 0.55.

If **Ergun** is selected, enter the mean **Particle diameter** d_p (default value: 0.5 mm). The permeability κ is then calculated using [Equation 2-4](#) in the *Porous Media Flow Module User's Guide*.



- [About Darcian and Non-Darcian Flow](#) in the *Porous Media Flow Module User's Guide*
 - [Permeability Models](#) in the *Porous Media Flow Module User's Guide*
-

Mass Source

Enter a value or expression for an optional mass source (or sink) **Source term** Q_m (SI unit: $\text{kg}/(\text{m}^3 \cdot \text{s})$). This term accounts for mass deposit or mass creation within porous domains. The physics interface assumes that the mass exchange occurs at zero velocity.

Effective Mass Transport Parameters

A correction factor (**Bruggeman**, **No Correction**, or **User defined**) to the mass transport parameters (defined in the **Transport Properties** node) can be applied for the porous domain. Species diffusivities and mobilities are automatically adjusted by the porous media corrections. For **User defined** enter a value or expression for the **Conversion factor** f_{eff} . The default is 1. Species diffusivities and mobilities are automatically adjusted by the porous media corrections.

Volume Force

The **Volume Force** node specifies the force \mathbf{F} on the right-hand side of the Navier–Stokes or Brinkman equations, depending on whether a [Fluid Properties](#) or [Porous Medium](#) node is active on the domain. It then acts on each fluid element in the specified domains.

VOLUME FORCE

Enter the components of the **Volume force \mathbf{F}** (SI unit: N/m^3).

Porous Electrode Coupling

Use the **Porous Electrode Coupling** node to define a mass source based on the volumetric current densities of one or multiple **Porous Electrode Reaction** nodes in an Electrochemistry interface.

The source (or sink) is proportional to the **Molar mass (kg/mol)** of the reacting species, the current densities and the stoichiometric coefficients according to Faraday's law as defined by summation over the Reaction Coefficient subnodes.

SPECIES

Based on the number of species required for the model, use the **Add** (**+**) and **Delete** (**✖**) buttons under the table to add or remove **Species**. Then enter a value for the **Molar mass (kg/mol)** in the applicable rows for each species.

The setting in the table will determine the number of available fields for entering the stoichiometric coefficients of the Reaction Coefficient subnodes.

Initial Values

The **Initial Values** node adds initial values for the velocity field and the pressure that can serve as an initial condition for a transient simulation or as an initial guess for a nonlinear solver.

INITIAL VALUES

Enter initial values or expressions for the **Velocity field \mathbf{u}** (SI unit: m/s) and for the **Pressure p** (SI unit: Pa). The default values are $0 \text{ m}/\text{s}$ and 0 Pa , respectively.

Gravity

The **Gravity** global feature is automatically added when **Include gravity** is selected at the interface level in the **Physical Model** settings. It defines the gravity forces from the **Acceleration of gravity** value. When a turbulence model that solves for the turbulent kinetic energy, k , is used, the option **Include buoyancy-induced turbulence** is available. When selected, the **Buoyancy contribution** is by default set to **Automatic from multiphysics**. Contributions are only obtained from multiphysics couplings that support buoyancy-induced turbulence, such as Nonisothermal Flow. If the **Buoyancy**

contribution is switched to **User defined**, a text field for the **Turbulent Schmidt number** appears. See also [Theory for Buoyancy-Induced Turbulence](#) in the *CFD Module User's Guide*.

This feature requires a specific license. For a detailed overview of the functionality available in each product visit <https://www.comsol.com/products/specifications/>.

ACCELERATION OF GRAVITY

The **Acceleration of gravity** (SI unit m/s, default value $-g_{\text{const}}\mathbf{e}_z$ in 2D axial symmetry and 3D and $-g_{\text{const}}\mathbf{e}_y$ in 2D) is used to define the gravity forces. It should be a global quantity.

Electrode-Electrolyte Interface Coupling

Use the **Electrode-Electrolyte Interface Coupling** node to define a combined wall and inflow/outflow boundary condition based on current densities of one or multiple [Electrode Reaction](#) nodes in an Electrochemistry interface.

The flow is proportional to the **Molar mass (kg/mol)** of the reacting species, the current densities and the stoichiometric coefficients according to Faraday's law as defined by summation over the Reaction Coefficient subnodes.

TANGENTIAL VELOCITY CONDITION

For information about this section, see the [Wall](#) node. **No slip** is the default, but **Slip** may in some cases be a more applicable, for instance if a gas diffusion electrode is modeled as a boundary condition.

SPECIES

Based on the number of species required for the model, use the **Add (+)** and **Delete ()** buttons under the table to add or remove **Species**. Then enter a value for the **Molar mass (kg/mol)** in the applicable rows for each species.

The setting in the table will determine the number of available field for entering the stoichiometric coefficients of the Reaction Coefficient subnodes.

Wall

The **Wall** node includes a set of boundary conditions describing fluid-flow conditions at stationary, moving, and leaking walls.

BOUNDARY CONDITION

Select a **Boundary condition** for the wall.

- [No Slip](#)¹
- [Slip](#)
- [Leaking Wall](#)

No Slip

No slip is the default boundary condition for a stationary solid wall for laminar flow (and SST, Low Re k - ϵ , Algebraic y Plus, L-VEL, and Spalart–Allmaras turbulence models). The condition prescribes $\mathbf{u} = 0$; that is, the fluid at the wall is not moving.

Slip

The **Slip** option prescribes a no-penetration condition, $\mathbf{u} \cdot \mathbf{n} = 0$. It is implicitly assumed that there are no viscous effects at the slip wall and hence, no boundary layer develops. From a modeling point of view, this can be a reasonable approximation if the main effect of the wall is to prevent fluid from leaving the domain.

Leaking Wall

This boundary condition may be used to simulate a wall where fluid is leaking into or leaving the domain with the velocity $\mathbf{u} = \mathbf{u}_1$ through a perforated wall. The components of the **Fluid velocity** \mathbf{u}_1 on the leaking wall should be specified.

CONSTRAINT SETTINGS

This section is displayed by clicking the **Show** button () and selecting **Advanced Physics Options**.



- [The Moving Mesh Interface](#) in the *COMSOL Multiphysics Reference Manual*
-

The Free and Porous Media Flow, Darcy Interface

The **Free and Porous Media Flow, Darcy** interface () combines the **Darcy's Law** and **Laminar Flow** interfaces to compute fluid velocity and pressure fields where free flow is connected to porous media. The physics interface is suited for situations when both the free flow and the flow in the porous media are laminar.

When a predefined **Free and Porous Media Flow, Darcy** interface is added from the **Porous Media and Subsurface Flow** branch () of the **Model Wizard** or **Add Physics** window, the **Darcy's Law** and **Laminar Flow** interfaces are added to the Model Builder. In addition, the **Multiphysics** node is added, which automatically includes the **Free and Porous Media Flow Coupling** multiphysics coupling.

On the Constituent Physics Interfaces

The **Darcy's Law** interface is used to simulate fluid flow through interstices in a porous medium. It can be used to model low-velocity flows in media where the permeability and porosity are very small, and for which the pressure gradient is the major driving force and the flow is mostly influenced by the frictional resistance within the pores.

The **Laminar Flow** interface is used to compute the velocity and pressure for a fluid flow in the laminar flow regime. A flow will remain laminar as long as the Reynolds number is below a certain critical value. At higher Reynolds numbers, disturbances have a tendency to grow and cause transition to turbulence.

SETTINGS FOR PHYSICS INTERFACES AND COUPLING FEATURES

When physics interfaces are added using the predefined couplings, for example **Free and Porous Media Flow, Darcy**, specific settings are included with the physics interfaces and the coupling features.

However, if physics interfaces are added one at a time, followed by the coupling features, these modified settings are not automatically included.

Free and Porous Media Flow Coupling (Multiphysics Coupling)

The **Free and Porous Media Flow Coupling** multiphysics coupling node () bidirectionally links the **Laminar Flow** and **Darcy's Law** interfaces.

SETTINGS

The **Label** is the default multiphysics coupling feature name.

The **Name** is used primarily as a scope prefix for variables defined by the coupling node. Refer to such variables in expressions using the pattern <name>.<variable_name>. In order to distinguish between variables belonging to different coupling nodes or physics interfaces, the **name** string must be unique. Only letters, numbers, and underscores (_) are permitted in the **Name** field. The first character must be a letter.

The default **Name** (for the first multiphysics coupling feature in the model) is `nsd1`.

DOMAIN SELECTION

When nodes are added from the context menu, you can select **Manual** (the default) from the **Selection** list to choose specific domains to define the multiphase flow coupling, or select **All domains** as needed.

When the **Free and Porous Media Flow Coupling** is added as an effect of adding a Free and Porous Media Flow, Darcy multiphysics interface, the selection is the intersection of the boundaries of the participating physics interfaces.

Only boundaries that are active in the participating physics interfaces (which are chosen from the **Coupled Interfaces** selection list) can be selected.

COUPLED INTERFACES

This section defines the physics involved in the multiphysics coupling. The **Free flow** and **Porous media flow** lists include all applicable physics interfaces.

The default values depend on how the coupling node is created.

- If it is added from the **Physics** ribbon (Windows users), **Physics** contextual toolbar (Mac and Linux users), or context menu (all users), then the first physics interface of each type in the component is selected as the default.
- If it is added automatically when a multiphysics interface is selected in the **Model Wizard** or **Add Physics** window, then the two participating physics interfaces are selected.

You can also select **None** from either list to uncouple the Free and Porous Media Flow Coupling node from a physics interface. If the physics interface is removed from the **Model Builder**, for example **Darcy's Law** is deleted, then the **Porous media flow** list defaults to **None** as there is nothing to couple to.

COUPLING SETTINGS

This section defines the settings for the **Free flow boundary condition**.

- When **No slip** is selected, the tangential component of the fluid velocity at the free-porous interface on the free-flow side (computed in the **Free flow** interface) is set to zero.
- When **Continuous tangential velocity** is selected, the tangential velocity component of the flow on both sides of the free-porous interface is continuous. In addition, continuity of normal stresses and conservation of mass across the interface are ensured.
- When **Beavers-Joseph** is selected, the difference of the tangential velocity components of the flow on both sides of the free-porous interface is proportional to the shear stress at the free-porous interface on the free-flow side. For this option, enter a value or expression for the **Beavers and Joseph parameter** a_{BJ} (dimensionless) that determines the proportionality. In addition, select the check box **Use projected permeability** to use only the component of the permeability tensor in the direction of the difference of the tangential velocities on both sides of the interface, instead of the trace of the permeability tensor, in determining the proportionality.
- When **Beavers-Joseph-Saffman** is selected, the tangential velocity component of the flow at the free-porous interface on the free-flow side is proportional to the shear stress at the interface on the free-flow side. For this option also, enter a value or expression for the **Beavers and Joseph parameter** a_{BJ} (dimensionless) that determines the proportionality. In addition, select the check box **Use projected permeability** to use only the component of the permeability tensor in the direction of the difference of the tangential velocities on both sides of the interface, instead of the trace of the permeability tensor, in determining the proportionality.
- When **Viscous slip** is selected, the difference of the tangential velocity components of the flow on the free-flow side and a user-supplied interfacial velocity is proportional to the shear stress at the free-porous interface on the free-flow side. Enter values for the **Slip length** L_s (SI unit: m, the default is $1e-7$ m), and an **Interfacial velocity** \mathbf{u}_b (SI unit: m/s, the default is 0 m/s).



In all the above cases, additionally continuity of normal stresses and conservation of mass across the interface are ensured.



Please find related information in the *CFD Module User's Guide*:

- [The Darcy's Law Interface](#)
 - [Theory for the Darcy's Law Interface](#)
 - [The Laminar Flow Interface](#)
 - [Theory for the Single-Phase Flow Interfaces](#)
 - [Theory for the Free and Porous Media Flow, Darcy Interface](#)
-

The Brinkman Equations Interface

The **Brinkman Equations (br)** interface (), found under the **Porous Media and Subsurface Flow** branch () when adding a physics interface, is used to compute fluid velocity and pressure fields of single-phase flow in porous media in the laminar flow regime. The physics interface extends Darcy’s law to describe the dissipation of the kinetic energy by viscous shear, similar to the Navier–Stokes equations. Fluids with varying density can be included at Mach numbers below 0.3. Also the viscosity of a fluid can vary, for example, to describe non-Newtonian fluids. To simplify the equations, select the Stokes–Brinkman flow feature to reduce the dependence on inertial effects when the Reynolds number is significantly less than 1. The physics interface can be used for stationary and time-dependent analyses.

The main node is the Porous Medium feature, which adds the Brinkman equations and provides interfaces for defining the fluid material and the porous matrix.

When this physics interface is added, the following default nodes are also added in the **Model Builder — Porous Medium, Wall** (the default boundary type, using **No slip** as the default boundary condition), and **Initial Values**. Then, from the **Physics** toolbar, add other nodes that implement, for example, boundary conditions and volume forces. You can also right-click **Brinkman Equations** to select physics features from the context menu.

The boundary conditions are essentially the same as for the Laminar Flow interface. Differences exist for the following boundary types: Outlet, Symmetry, Open Boundary, and Boundary Stress where the viscous part of the stress is divided by the porosity to appear as

$$\frac{1}{\varepsilon_p} \left\{ \mu(\nabla \mathbf{u} + (\nabla \mathbf{u})^T) - \frac{2}{3} \mu(\nabla \cdot \mathbf{u}) \mathbf{I} \right\}$$

In the *COMSOL Multiphysics Reference Manual* see [Table 2-4](#) for links to common sections such as **Discretization**, **Consistent Stabilization**, **Inconsistent Stabilization**, and **Advanced Settings**, all accessed by clicking the **Show** button () and choosing the applicable option. You can also search for information: press F1 to open the **Help** window or Ctrl+F1 to open the **Documentation** window.

SETTINGS

The **Label** is the default physics interface name.

The **Name** is used primarily as a scope prefix for variables defined by the physics interface. Refer to such physics interface variables in expressions using the pattern `<name>.<variable_name>`. In order to distinguish between variables belonging to different physics interfaces, the **name** string must be unique. Only letters, numbers, and underscores (`_`) are permitted in the **Name** field. The first character must be a letter.

The default **Name** (for the first physics interface in the model) is `br`.

PHYSICAL MODEL

This node specifies the properties of the Brinkman Equations interface, which describe the overall type of fluid flow model.

Compressibility

By default the physics interface uses the **Incompressible flow** formulation of the Brinkman equations to model constant density flow. Alternatively, from the **Compressibility** list select **Weakly compressible flow**, which should be used when the pressure dependency of the density can be neglected, or **Compressible flow (Ma<0.3)** to solve for the full compressible flow of which, however, the Mach number must be below 0.3.

Swirl Flow

For 2D axisymmetric models, select the **Swirl flow** check box to include the swirl velocity component, that is the velocity component u_φ in the azimuthal direction. While u_φ can be nonzero, there can be no gradients in the φ direction.

Note that this feature is only available for specific modules. See <https://www.comsol.com/products/specifications/> for a detailed overview.

Neglect Inertial Term (Stokes–Brinkman Flow)

The **Neglect inertial term (Stokes–Brinkman)** check box is selected by default to model flow at low Reynolds numbers for which the inertial term can be neglected. This results in the linear Stokes–Brinkman equations.

Include Gravity

Gravity is not included by default. Select the **Include gravity** check box to activate the acceleration of gravity. This automatically adds a global **Gravity** feature node to the interface model tree, and the buoyancy force is included in the Equations.

Also, when the **Include gravity** check box is selected, the **Use reduced pressure** option changes the pressure formulation from using the total pressure (default) to using the reduced pressure. This option is suitable for configurations where the density changes

are very small; otherwise, the default formulation can be used. For more information, see [Gravity](#).

Porous Treatment of No Slip Condition

Choose how the **No Slip** condition on **Wall** boundaries and **Interior Wall** boundaries adjacent to **Porous Medium** should be treated. The options are **Standard no slip formulation** and **Porous slip** (default). The latter option provides a unified treatment when the porous matrix is fully resolved as well as when it is under resolved ensuring a smooth transition between regions with different resolutions; see No Slip under [Wall](#) in the [The Laminar Flow and Creeping Flow Interfaces](#) section.

Reference Pressure Level

Enter a **Reference pressure level** p_{ref} (SI unit: Pa). The default value is 1 [atm].

Reference Temperature Level

Enter a **Reference temperature level** T_{ref} (SI unit: K). The default value is 293.15 [K].

Reference Position

If **Include gravity** is selected, a **Reference position** r_{ref} (SI unit: m) can be specified which is then used for the calculation of the hydrostatic pressure.

TURBULENCE

Turbulent flow can be simulated by changing the **Turbulence model type** to **RANS** (Reynolds-Averaged Navier–Stokes). If turbulent flow is activated, you can set the **Turbulence model** either to one of the algebraic turbulence models, **Algebraic yPlus** (the default) or **L-VEL**, or to one of the following two-equation turbulence models: k - ϵ , Low Reynolds Number k - ϵ . The **Wall treatment** is set to **Automatic** (default) or **Low Re** while **Wall functions** is the only option for k - ϵ . For more information about turbulence modeling, see [Theory for the Turbulent Flow Interfaces](#) in the *CFD Module User's Guide*.

DEPENDENT VARIABLES

The following dependent variables (fields) are defined for this physics interface — the **Velocity field** \mathbf{u} (SI unit: m/s) and its components, and the **Pressure** p (SI unit: Pa).

ADVANCED SETTINGS

To display this section, click the **Show More Options** button () and select **Advanced Physics Options** in the **Show More Options** dialog box. Normally these settings do not need to be changed.

The **Use pseudo time stepping for stationary equation form** option adds pseudo time derivatives to the equation when the **Stationary equation** form is used in order to speed up convergence. When selected, a **CFL number expression** should also be defined. For the default **Automatic** option, the local CFL number (from the Courant–Friedrichs–Lewy condition) is determined by a PID regulator.

-
- [Domain, Boundary, Point, and Pair Nodes for the Brinkman Equations Interface](#)

- [Theory for the Brinkman Equations Interface](#)

In the *COMSOL Multiphysics Reference Manual*:



- [Pseudo Time Stepping for Laminar Flow Models and Pseudo Time Stepping](#)
 - [Numerical Stability — Stabilization Techniques for Fluid Flow](#)
 - [Nitsche Constraints](#)
-

Domain, Boundary, Point, and Pair Nodes for the Brinkman Equations Interface

The [Brinkman Equations Interface](#) has the following domain, boundary, point, and pair nodes, listed in alphabetical order, available from the **Physics** ribbon toolbar (Windows users), **Physics** context menu (Mac or Linux users), or right-click to access the context menu (all users).



In general, to add a node, go to the **Physics** toolbar, no matter what operating system you are using. Subnodes are available by clicking the parent node and selecting it from the **Attributes** menu.

These nodes are described in this section:

- [Porous Medium](#)
- [Initial Values](#)
- [Mass Source](#)
- [Volume Force](#)
- [Fluid Properties](#)

The following nodes (listed in alphabetical order) are described for the Laminar Flow interface in the *COMSOL Multiphysics Reference Manual*:

- Flow Continuity
- Inlet
- Line Mass Source
- Boundary Stress
- Outlet
- Open Boundary
- Periodic Flow Condition
- Point Mass Source
- Pressure Point Constraint
- Symmetry
- Wall



In the *COMSOL Multiphysics Reference Manual* see [Table 2-4](#) for links to common sections and [Table 2-5](#) to common feature nodes. You can also search for information: press F1 to open the **Help** window or Ctrl+F1 to open the **Documentation** window.

Porous Medium

The **Porous Medium** node adds the Brinkman equations: [Equation 4-34](#) and [Equation 4-35](#) (excluding any mass sources). It has two default subfeatures — the [Fluid](#) subfeature where the fluid density ρ (SI unit: kg/m^3) and dynamic viscosity μ (SI unit: Pa·s) are defined and the [Porous Matrix](#) subfeature where the permeability κ (SI unit: m^2) and porosity ε_p (dimensionless) are specified.

COORDINATE SYSTEM SELECTION

Select a coordinate system from the **Coordinate system** list for the interpretation of directions in anisotropic material properties. The default is the **Global coordinate system**, and the list contains any additional orthonormal coordinate system (except boundary coordinate systems) added under the Definitions node.

The subnodes inherit these coordinate system settings. In particular, the **Permeability** (in the **Porous Matrix** subnode) should be set according to the coordinate system selected in this section.

FLOW MODEL

Define if the flow follows a linear or nonlinear pressure-velocity relationship.

- **Darcian flow** (default) defines a linear relationship characteristic for low Reynolds number laminar flows.
- **Non-Darcian flow** defines a nonlinear relationship due to inertial or turbulence effects.

POROUS MEDIUM TURBULENCE MODEL

If in the parent feature node a turbulence model other than **Algebraic yPlus** or **L-VEL** is selected, define a model which complements the basic turbulence model and accounts for the influence of the porous matrix on turbulent flow in porous media.

- For **Default** and **Nakayama-Kuwahara** specify the **Coefficient of subgrid turbulence generation by porous matrix** C_{stpm} which by default is set to 0.212.
- For **Pedras-de Lemos**, specify the **Choice of the Pedras-de Lemos model coefficient**. When **User defined** is chosen, specify the **Coefficient of subgrid turbulence generation by porous matrix** C_{stpm} with default value 0.212. Choosing **Original** results in $C_{\text{stpm}} = 0.28 \cdot \sqrt{\varepsilon_p}$, while choosing **Recalibrated** results in $C_{\text{stpm}} = 0.18$.

DISTANCE EQUATION

This section is available for the turbulence models **Algebraic yPlus** or **L-VEL**. Select how the **Reference length scale** l_{ref} (SI unit: m) is defined — **Automatic** (default) or **Manual**:

- For **Automatic** the wall distance is automatically evaluated to one tenth of the shortest side of the geometry bounding box. This is usually quite accurate but it can sometimes give a too high value if the geometry consists of several slim entities. In such cases, define the reference length scale manually.
- For **Manual** it defines a different value or expression for the length scale. The default is 1 m.

l_{ref} controls the result of the distance equation. Objects that are much smaller than l_{ref} are effectively be diminished while the distance to objects much larger than l_{ref} are accurately represented.

Fluid

This node defines the material properties of the fluid of the **Porous Medium** parent node.

MODEL INPUT

This section contains fields and values that are inputs for expressions defining material properties. If such user-defined property groups are added, the model inputs appear here.

FLUID PROPERTIES

Specify the **Density** ρ and the **Dynamic viscosity** μ (SI unit: Pa·s) of the fluid. The defaults use values **From material**, for **User defined** enter a value or expression.

The dynamic viscosity describes the relationship between the shear stresses and the shear rate in a fluid. Intuitively, water and air have a low viscosity, and substances often described as thick, such as oil, have a higher viscosity.

Porous Matrix

This node defines the porosity and material properties of the solid matrix of the **Porous Medium** parent node.

MODEL INPUT

This section contains fields and values that are inputs for expressions defining material properties. If such user-defined property groups are added, the model inputs appear here.

MATRIX PROPERTIES

The **Porosity** ε_p (a dimensionless number between 0 and 1) uses by default the value **From material**. For **User defined** the default value is 1.

Select a **Permeability model** to specify the capacity of the porous material to transmit flow. Depending on the **Flow model** selection in the parent **Porous Medium** feature node you can choose between the following options:

- **Permeability** (the default) to directly enter the permeability of the porous matrix or **Kozeny-Carman** to define the permeability from the porosity and mean **Particle diameter** for **Darcian** flow or
- **Forchheimer** or **Ergun** for **Non-Darcian** flow.

Note that some of these options are only available for certain modules. For a detailed overview of the functionality available in each product, visit <https://www.comsol.com/products/specifications/>.

The default **Permeability** κ (SI unit: m^2) uses the value **From material**, as defined by the **Porous material** list. For **User defined** select **Isotropic** to define a scalar value or **Diagonal** or **Symmetric** to define a tensor value.

For **Kozeny-Carman**, enter the mean **Particle diameter** d_p (SI unit: m), the default value is 0.5 mm.

In case a **Non-Darcian** flow model is chosen in the parent node, **Forchheimer** is the default selection for the **Permeability model**. For **Forchheimer**, the default **Permeability** κ (SI unit: m^2) uses the value **From material**. Furthermore, the dimensionless **Forchheimer parameter** c_F can be defined. The default value is 0.55.

If **Ergun** is selected, enter the mean **Particle diameter** d_p (default value: 0.5 mm). The permeability κ is then calculated using [Equation 2-4](#) in the *Porous Media Flow Module User's Guide*.



- [About Darcian and Non-Darcian Flow](#) in the *Porous Media Flow Module User's Guide*
- [Permeability Models](#) in the *Porous Media Flow Module User's Guide*

Mass Source

The **Mass Source** node adds a mass source (or mass sink) Q_m to the right-hand side of the continuity equation: [Equation 7-68](#). This term accounts for mass deposit and/or mass creation in porous domains. The physics interface assumes that the mass exchange occurs at zero velocity.

$$\frac{\partial}{\partial t}(\epsilon_p \rho) + \nabla \cdot (\rho \mathbf{u}) = Q_m \quad (7-20)$$

DOMAIN SELECTION

Only Porous Matrix domains are available.

MASS SOURCE

Enter a value or expression for the **Source term** Q_{br} (SI unit: $\text{kg}/(\text{m}^3 \cdot \text{s})$). The default is $0 \text{ kg}/(\text{m}^3 \cdot \text{s})$.

Volume Force

Use the **Volume Force** node to specify the force \mathbf{F} on the right-hand side of Equation 7-69. It then acts on each fluid element in the specified domains.

$$\frac{\rho}{\varepsilon_p} \left(\frac{\partial \mathbf{u}}{\partial t} + (\mathbf{u} \cdot \nabla) \frac{\mathbf{u}}{\varepsilon_p} \right) = -\nabla p + \nabla \cdot \left[\frac{1}{\varepsilon_p} \left\{ \mu (\nabla \mathbf{u} + (\nabla \mathbf{u})^T) - \frac{2}{3} \mu (\nabla \cdot \mathbf{u}) \mathbf{I} \right\} \right] - \left(\kappa^{-1} \mu + \frac{Q_m}{\varepsilon_p^2} \right) \mathbf{u} + \mathbf{F} \quad (7-21)$$

VOLUME FORCE

Enter the components of **Volume force** \mathbf{F} (SI unit: N/m³).

Initial Values

The **Initial Values** node adds initial values for the velocity field and the pressure that can serve as an initial condition for a transient simulation or as an initial guess for a nonlinear solver.

INITIAL VALUES

Enter initial values or expressions for the **Velocity field** \mathbf{u} (SI unit: m/s) and the **Pressure** p (SI unit: Pa). The default values are 0 m/s and 0 Pa, respectively.

Fluid Properties

The **Fluid Properties** node adds the momentum and continuity equations to solve for free flow in nonporous domains. The node also provides an interface for defining the material properties of the fluid.

MODEL INPUTS

Fluid properties, such as density and viscosity, can be defined through user inputs, variables, or by selecting a material. For the latter option, additional inputs — for example, temperature or pressure — may be required to define these properties.

Temperature

By default, the single-phase flow interfaces are set to model isothermal flow. Hence, the **Temperature** is **User defined** and defaults to 293.15 K. If a Heat Transfer interface is included in the component, the temperature may alternatively be selected from this physics interface. All physics interfaces have their own tags (**Name**). For example, if a

Heat Transfer in Fluids interface is included in the component, the **Temperature (ht)** option is available.

Absolute Pressure

This input appears when a material requires the absolute pressure as a model input. The absolute pressure is used to evaluate material properties, but it also relates to the value of the calculated pressure field. There are generally two ways to calculate the pressure when describing fluid flow: either to solve for the absolute pressure or for a pressure (often denoted gauge pressure) that relates to the absolute pressure through a reference pressure.

The choice of pressure variable depends on the system of equations being solved. For example, in a unidirectional incompressible flow problem, the pressure drop over the modeled domain is probably many orders of magnitude smaller than the atmospheric pressure, which, when included, may reduce the stability and convergence properties of the solver. In other cases, such as when the pressure is part of an expression for the gas volume or the diffusion coefficients, it may be more convenient to solve for the absolute pressure.

The default **Absolute pressure** p_A is $p+p_{\text{ref}}$ where p is the dependent pressure variable from the Navier–Stokes equations, and p_{ref} is from the user input defined at the physics interface level. When p_{ref} is nonzero, the physics interface solves for a gauge pressure. If the pressure field instead is an absolute pressure field, p_{ref} should be set to 0.

The **Absolute pressure** field can be edited by clicking **Make All Model Inputs Editable** () and entering the desired value in the input field.

FLUID PROPERTIES

If density variations with respect to pressure are to be included in the computations, the flow must be set to compressible.

The **Dynamic viscosity** μ describes the relationship between the shear rate and the shear stresses in a fluid. Intuitively, water and air have low viscosities, and substances often described as thick (such as oil) have higher viscosities.

Gravity

The **Gravity** global feature is automatically added when **Include gravity** is selected at the interface level in the **Physical Model** settings. It defines the gravity forces from the **Acceleration of gravity** value. When a turbulence model that solves for the turbulent

kinetic energy, k , is used, the option **Include buoyancy-induced turbulence** is available. When selected, the **Buoyancy contribution** is by default set to **Automatic from multiphysics**. Contributions are only obtained from multiphysics couplings that support buoyancy-induced turbulence, such as Nonisothermal Flow. If the **Buoyancy contribution** is switched to **User defined**, a text field for the **Turbulent Schmidt number** appears. See also [Theory for Buoyancy-Induced Turbulence](#) in the *CFD Module User's Guide*.

This feature requires a specific license. For a detailed overview of the functionality available in each product visit <https://www.comsol.com/products/specifications/>.

ACCELERATION OF GRAVITY

The **Acceleration of gravity** (SI unit m/s, default value $-g_{\text{const}}\mathbf{e}_z$ in 2D axial symmetry and 3D and $-g_{\text{const}}\mathbf{e}_y$ in 2D) is used to define the gravity forces. It should be a global quantity.

Theory for the Laminar Flow and Creeping Flow Interfaces

The theory for the Single-Phase Flow, Laminar Flow interface is described in this section:

- [General Single-Phase Flow Theory](#)
- [Compressible Flow](#)
- [Weakly Compressible Flow](#)
- [The Mach Number Limit](#)
- [Incompressible Flow](#)
- [The Reynolds Number](#)
- [Gravity](#)
- [Theory for the Wall Boundary Condition](#)
- [Prescribing Inlet and Outlet Conditions](#)
- [Mass Flow](#)
- [Fully Developed Flow \(Inlet\)](#)
- [Fully Developed Flow \(Outlet\)](#)
- [No Viscous Stress](#)
- [Normal Stress Boundary Condition](#)
- [Porous Interface](#)
- [Mass Sources for Fluid Flow](#)
- [Numerical Stability — Stabilization Techniques for Fluid Flow](#)
- [Solvers for Laminar Flow](#)
- [Pseudo Time Stepping for Laminar Flow Models](#)
- [Nitsche Constraints](#)
- [Particle Tracing in Fluid Flow](#)
- [References for the Single-Phase Flow, Laminar Flow Interfaces](#)



The theory about most boundary conditions is found in [Ref. 2](#).

General Single-Phase Flow Theory

The Single-Phase Fluid Flow interfaces are based on the Navier–Stokes equations, which in their most general form read

$$\frac{\partial \rho}{\partial t} + \nabla \cdot (\rho \mathbf{u}) = 0 \quad (7-22)$$

$$\rho \frac{\partial \mathbf{u}}{\partial t} + \rho (\mathbf{u} \cdot \nabla) \mathbf{u} = \nabla \cdot [-p \mathbf{I} + \mathbf{K}] + \mathbf{F} \quad (7-23)$$

$$\rho C_p \left(\frac{\partial T}{\partial t} + (\mathbf{u} \cdot \nabla) T \right) = -(\nabla \cdot \mathbf{q}) + \mathbf{K} : \mathbf{S} - \frac{T}{\rho} \frac{\partial \rho}{\partial T} \bigg|_p \left(\frac{\partial p}{\partial t} + (\mathbf{u} \cdot \nabla) p \right) + Q \quad (7-24)$$

where

- ρ is the density (SI unit: kg/m³)
- \mathbf{u} is the velocity vector (SI unit: m/s)
- p is pressure (SI unit: Pa)
- \mathbf{I} is the identity matrix (unitless)
- \mathbf{K} is the viscous stress tensor (SI unit: Pa)
- \mathbf{F} is the volume force vector (SI unit: N/m³)
- C_p is the specific heat capacity at constant pressure (SI unit: J/(kg·K))
- T is the absolute temperature (SI unit: K)
- \mathbf{q} is the heat flux vector (SI unit: W/m²)
- Q contains the heat sources (SI unit: W/m³)
- \mathbf{S} is the strain-rate tensor:

$$\mathbf{S} = \frac{1}{2} (\nabla \mathbf{u} + (\nabla \mathbf{u})^T)$$

The operation “:” denotes a contraction between tensors defined by

$$\mathbf{a} : \mathbf{b} = \sum_n \sum_m a_{nm} b_{nm} \quad (7-25)$$

This is sometimes referred to as the double dot product.

[Equation 7-22](#) is the continuity equation and represents conservation of mass.

[Equation 7-23](#) is a vector equation which represents conservation of momentum.

Equation 7-24 describes the conservation of energy, formulated in terms of temperature. This is an intuitive formulation that facilitates boundary condition specifications.

To close the equation system, Equation 7-22 through Equation 7-24, constitutive relations are needed.

For a Newtonian fluid, which has a linear relationship between stress and strain, Stokes (Ref. 1) deduced the following expression:

$$\mathbf{K} = 2\mu\mathbf{S} - \frac{2}{3}\mu(\nabla \cdot \mathbf{u})\mathbf{I} \quad (7-26)$$

The dynamic viscosity, μ (SI unit: Pa·s), for a Newtonian fluid is allowed to depend on the thermodynamic state but not on the velocity field. All gases and many liquids can be considered Newtonian.

For an inelastic non-Newtonian fluid, the relationship between stress and strain rate is nonlinear, and an apparent viscosity is introduced instead of the dynamic viscosity. Examples of non-Newtonian fluids are honey, mud, blood, liquid metals, and most polymer solutions.

In theory, the same equations describe both laminar and turbulent flows. In practice, however, the mesh resolution required to simulate turbulence with the Laminar Flow interface makes such an approach impractical.



There are several books where derivations of the Navier–Stokes equations and detailed explanations of concepts such as Newtonian fluids can be found. See, for example, the classical text by Batchelor (Ref. 3) and the more recent work by Panton (Ref. 4).

Many applications describe isothermal flows for which Equation 7-24 is decoupled from Equation 7-22 and Equation 7-23.

2D AXISYMMETRIC FORMULATIONS

A 2D axisymmetric formulation of Equation 7-22 and Equation 7-23 requires $\partial/\partial\phi$ to be zero. That is, there must be no gradients in the azimuthal direction. A common additional assumption is, however, that $u_\phi = 0$. In such cases, the ϕ -equation can be removed from Equation 7-23. The resulting system of equations is both easier to converge and computationally less expensive compared to retaining the ϕ -equation.

The default 2D axisymmetric formulation of [Equation 7-22](#) and [Equation 7-23](#) therefore assumes that

$$\begin{aligned}\partial/\partial\phi &= 0 \\ u_\phi &= 0\end{aligned}$$

Compressible Flow

The equations of motion for a single-phase fluid are the continuity equation:

$$\frac{\partial\rho}{\partial t} + \nabla \cdot (\rho\mathbf{u}) = 0 \quad (7-27)$$

and the momentum equation:

$$\rho \frac{\partial\mathbf{u}}{\partial t} + \rho\mathbf{u} \cdot \nabla\mathbf{u} = -\nabla p + \nabla \cdot \left(\mu(\nabla\mathbf{u} + (\nabla\mathbf{u})^T) - \frac{2}{3}\mu(\nabla \cdot \mathbf{u})\mathbf{I} \right) + \mathbf{F} \quad (7-28)$$

These equations are applicable for incompressible as well as for compressible flow with density and viscosity variations.

Weakly Compressible Flow

The same equations as for [Compressible Flow](#) are applied for weakly compressible flow. The only difference is that the density is evaluated at the reference pressure. The density may be a function of other quantities, in particular it may be temperature dependent.

The weakly compressible flow equations are valid for incompressible as well as compressible flow with density variations independent of the pressure.

Provided that the densities dependency pressure is specified through model inputs, the density is automatically evaluated at the reference pressure level.

The Mach Number Limit

An important dimensionless number in fluid dynamics is the Mach number, Ma , defined by

$$\text{Ma} = \frac{|\mathbf{u}|}{a}$$

where a is the speed of sound. A flow is formally incompressible when $Ma = 0$. This is theoretically achieved by letting the speed of sound tend to infinity. The Navier–Stokes equations then have the mathematical property that pressure disturbances are instantaneously propagated throughout the entire domain. This results in a parabolic equation system.

The momentum equation, Equation 7-28, is parabolic for unsteady flow and elliptic for steady flow, whereas the continuity equation, Equation 7-27, is hyperbolic for both steady and unsteady flow. The combined system of equations is thus hybrid parabolic-hyperbolic for unsteady flow and hybrid elliptic-hyperbolic for steady flow. An exception occurs when the viscous term in Equation 7-28 becomes vanishingly small, such as at an outflow boundary, in which case the momentum equation becomes locally hyperbolic. The number of boundary conditions to apply on the boundary then depends on the number of characteristics propagating into the computational domain. For the purely hyperbolic system, the number of characteristics propagating from the boundary into the domain changes as the Mach number passes through unity. Hence, the number of boundary conditions required to obtain a numerically well-posed system must also change. The compressible formulation of the laminar and turbulent interfaces uses the same boundary conditions as the incompressible formulation, which implies that the compressible interfaces are not suitable for flows with a Mach number larger than or equal to one. Yet, the practical Mach number limit is lower than one. The main reason is that the numerical scheme (stabilization and boundary conditions) of the Laminar Flow interface does not recognize the direction and speed of pressure waves. The fully compressible Navier–Stokes equations do, for example, start to display very sharp gradients already at moderate Mach numbers. But the stabilization for the single-phase flow interface does not necessarily capture these gradients. It is impossible to give an exact limit where the low Mach number regime ends and the moderate Mach number regime begins, but a rule of thumb is that the Mach number effects start to appear at $Ma = 0.3$. For this reason, the compressible formulation is referred to as *Compressible flow* ($Ma < 0.3$) in COMSOL Multiphysics.

Incompressible Flow

When the temperature variations in the flow are small, a single-phase fluid can often be assumed incompressible; that is, ρ is constant or nearly constant. This is the case for all liquids under normal conditions and also for gases at low velocities. For constant ρ , Equation 7-27 reduces to

$$\rho \nabla \cdot \mathbf{u} = 0 \quad (7-29)$$

and Equation 7-28 becomes

$$\rho \frac{\partial \mathbf{u}}{\partial t} + \rho(\mathbf{u} \cdot \nabla) \mathbf{u} = \nabla \cdot [-p \mathbf{I} + \mu(\nabla \mathbf{u} + (\nabla \mathbf{u})^T)] + \mathbf{F} \quad (7-30)$$

Provided that the densities dependency on temperature and pressure is specified through model inputs, the density is evaluated at the reference pressure level and at the reference temperature. However, if the density is a function of other quantities such as a concentration field, or if the density is specified by a user defined expression, the user has to make sure that the density is defined as constant when the incompressible flow formulation is used.

The Reynolds Number

A fundamental characteristic in analyses of fluid flow is the Reynolds number:

$$\text{Re} = \frac{\rho U L}{\mu}$$

where U denotes a velocity scale, and L denotes a representative length. The Reynolds number represents the ratio between inertial and viscous forces. At low Reynolds numbers, viscous forces dominate and tend to damp out all disturbances, which leads to laminar flow. At high Reynolds numbers, the damping in the system is very low, giving small disturbances the possibility to grow by nonlinear interactions. If the Reynolds number is high enough, the flow field eventually ends up in a chaotic state called turbulence.

Note that the Reynolds number can have different meanings depending on the length scale and velocity scale. To be able to compare two Reynolds numbers, they must be based on equivalent length and velocity scales.

The Fluid Flow interfaces automatically calculate the local cell Reynolds number $\text{Re}^c = \rho |\mathbf{u}| h / (2\mu)$ using the element length h for L and the magnitude of the velocity vector \mathbf{u} for the velocity scale U . This Reynolds number is not related to the character of the flow field, but to the stability of the numerical discretization. The risk for numerical oscillations in the solution increases as Re^c grows. The cell Reynolds number is a predefined quantity available for visualization and evaluation (typically it is available as: `spf.cellRe`).

DEFINITION

The gravity force is defined from the acceleration of gravity vector, \mathbf{g} , and the density, ρ . Under usual conditions and in Cartesian coordinates with the z -axis in the vertical direction,

$$\mathbf{g} = \begin{pmatrix} 0 \\ 0 \\ -\mathbf{g}_{\text{const}} \end{pmatrix}.$$

When gravity is considered, a volume force equal to $\rho\mathbf{g}$ is included in the momentum equation. For example, for laminar weakly compressible flow, it reads:

$$\rho \frac{\partial \mathbf{u}}{\partial t} + \rho \mathbf{u} \cdot \nabla \mathbf{u} = \nabla \cdot \left(-p \mathbf{I} + \mu (\nabla \mathbf{u} + (\nabla \mathbf{u})^T) - \frac{2}{3} \mu (\nabla \cdot \mathbf{u}) \mathbf{I} \right) + \mathbf{F} + \rho \mathbf{g} \quad (7-31)$$

Introducing a constant reference density ρ_{ref} , and assuming that \mathbf{g} is homogeneous, this equation is equivalently written:

$$\begin{aligned} \rho \frac{\partial \mathbf{u}}{\partial t} + \rho \mathbf{u} \cdot \nabla \mathbf{u} = & \\ \nabla \cdot \left(-p \mathbf{I} + \mu (\nabla \mathbf{u} + (\nabla \mathbf{u})^T) - \frac{2}{3} \mu (\nabla \cdot \mathbf{u}) \mathbf{I} + \rho_{\text{ref}} \mathbf{g} \cdot (\mathbf{r} - \mathbf{r}_{\text{ref}}) \mathbf{I} \right) + \mathbf{F} + (\rho - \rho_{\text{ref}}) \mathbf{g} & \end{aligned} \quad (7-32)$$

where \mathbf{r} is the position vector and \mathbf{r}_{ref} is an arbitrary reference position vector.

From this equation, it is convenient to define the reduced pressure which accounts for the hydrostatic pressure, $\tilde{p} = p - \rho_{\text{ref}} \mathbf{g} \cdot (\mathbf{r} - \mathbf{r}_{\text{ref}})$

$$\begin{aligned} \rho \frac{\partial \mathbf{u}}{\partial t} + \rho \mathbf{u} \cdot \nabla \mathbf{u} = \nabla \cdot \left(-\tilde{p} \mathbf{I} + \mu (\nabla \mathbf{u} + (\nabla \mathbf{u})^T) - \frac{2}{3} \mu (\nabla \cdot \mathbf{u}) \mathbf{I} \right) + & \\ \mathbf{F} + (\rho - \rho_{\text{ref}}) \mathbf{g} & \end{aligned} \quad (7-33)$$

In Equation 7-33, the gravity force is written $(\rho - \rho_{\text{ref}}) \mathbf{g}$.

PRESSURE FORMULATION

When the relative pressure is used (default option) the interface dependent variable represents the relative pressure and the absolute pressure is defined as $p_A = p_{\text{ref}} + p$. When the pressure is used to define a boundary condition (for example, when p_0

defines the pressure condition at an outlet), it represents the relative pressure. Hence defining the outlet pressure as $p_{\text{hydro,approx}} = -\rho_{\text{ref}}\mathbf{g} \cdot (\mathbf{r} - \mathbf{r}_{\text{ref}})$ compensates for the gravity force for an ambient reference pressure of 0 Pa when the density is constant, there is no external force, and provided p_{ref} , \mathbf{g} , and \mathbf{r}_0 are defined consistently.

When the reduced pressure is used, the interface dependent variable (named p by default) represents the reduced pressure. The absolute pressure is then defined as $p_A = p_{\text{ref}} - \rho_{\text{ref}}\mathbf{g} \cdot (\mathbf{r} - \mathbf{r}_{\text{ref}}) + p$. In this case when the pressure is used to define a boundary condition (for example, to define a pressure condition at an outlet), its value corresponds to the reduced pressure. Hence, the prescribed pressure compensates for an approximate hydrostatic pressure, $p_{\text{hydro,approx}} = -\rho_{\text{ref}}\mathbf{g} \cdot (\mathbf{r} - \mathbf{r}_{\text{ref}})$, which is exact only when the density is constant and there is no external force.

PRESSURE BOUNDARY CONDITION

For an immobile fluid the momentum equation simplifies to $\nabla \cdot (p\mathbf{I}) = \mathbf{F} + \rho\mathbf{g}$ or

$$\nabla \cdot (-\tilde{p}\mathbf{I}) = \mathbf{F} + (\rho - \rho_{\text{ref}})\mathbf{g} \text{ depending on the pressure formulation.}$$

For incompressible flow, assuming there are no external forces, this leads respectively to $p = -\rho_{\text{ref}}\mathbf{g} \cdot (\mathbf{r} - \mathbf{r}_{\text{ref}}) + p_0$ or $\tilde{p} = p_0$.

Theory for the Wall Boundary Condition

See [Wall](#) for the node settings.

SLIP

The [Slip](#) condition assumes that there are no viscous effects at the slip wall and hence, no boundary layer develops. From a modeling point of view, this is a reasonable approximation if the important effect of the wall is to prevent fluid from leaving the domain. Mathematically, the constraint can be formulated as:

$$\mathbf{u} \cdot \mathbf{n} = 0, \quad (-p\mathbf{I} + \mu(\nabla\mathbf{u} + (\nabla\mathbf{u})^T))\mathbf{n} = \mathbf{0}$$

The no-penetration term takes precedence over the Neumann part of the condition and the above expression is therefore equivalent to

$$\mathbf{u} \cdot \mathbf{n} = 0, \quad \mathbf{K}_n - (\mathbf{K}_n \cdot \mathbf{n})\mathbf{n} = \mathbf{0}$$

$$\mathbf{K}_n = \mu(\nabla\mathbf{u} + (\nabla\mathbf{u})^T)\mathbf{n}$$

expressing that there is no flow across the boundary and no viscous stress in the tangential direction.

For a moving wall with translational velocity \mathbf{u}_{tr} , \mathbf{u} in the above equations is replaced by the relative velocity $\mathbf{u}_{rel} = \mathbf{u} - \mathbf{u}_{tr}$.

POROUS SLIP

The **Porous slip** option, which can be chosen in the **Porous treatment of no slip condition** list when **Enable porous media domains** is activated, results in a special treatment of **Wall** boundaries and **Interior Wall** boundaries adjacent to porous domains (**Porous Medium** feature). Namely, similar to the **Navier slip** boundary condition, no penetration and tangential stress conditions are applied at the wall:

$$\mathbf{u} \cdot \mathbf{n} = 0, \quad \mathbf{K}_n - (\mathbf{K}_n \cdot \mathbf{n})\mathbf{n} = -\frac{\mu}{\varepsilon_p} \frac{\mathbf{u}_{slip}}{y_{ps}},$$

$$\mathbf{u}_{slip} = \mathbf{u} - (\mathbf{u} \cdot \mathbf{n})\mathbf{n}, \quad \mathbf{K}_n = \frac{\mu}{\varepsilon_p} (\nabla \mathbf{u} + (\nabla \mathbf{u})^T)\mathbf{n}$$

Here, \mathbf{K}_n is the viscous wall traction, \mathbf{n} is the wall normal, \mathbf{u}_{slip} is the tangential velocity at the wall while real no slip is assumed to be applied at a distance d_w (half-height of the first cell adjacent to the wall) outside the wall, and y_{ps} is the porous slip length. An analytical derivation of the velocity profile in the boundary layer where the pressure gradient is balanced by the sum of the Darcy term, the Forchheimer drag, and the viscous term (neglecting convective terms) leads to the following expression for y_{ps} :

$$y_{ps} = \tilde{l} \left(\frac{1 + X_p e^{-\xi_p}}{1 - X_p e^{-\xi_p}} \right) \left[\left(\frac{1 + X_p e^{-\xi_p}}{1 + X_p} \right)^2 e^{\xi_p} - 1 \right], \quad \xi_p = \frac{d_w}{l}, \quad \tilde{l} = \frac{l_{pore}}{\sqrt{1 + 2c_\beta}},$$

$$X_p = \frac{\sqrt{1 + 2c_\beta} - \sqrt{1 + \frac{4}{3}c_\beta}}{\sqrt{1 + 2c_\beta} + \sqrt{1 + \frac{4}{3}c_\beta}}, \quad c_\beta = \frac{\sqrt{1 + 4c_D} - 1}{2}, \quad c_D = \frac{\beta_{ND}}{\mu} \frac{\kappa^2}{\mu} |\nabla p - \rho \mathbf{g}|$$

where $l_{pore} = \sqrt{\kappa/\varepsilon_p}$ is the porous length scale, $\beta_{ND} = \rho c_F/\sqrt{\kappa}$ is the non-Darcian coefficient (c_F is the Forchheimer coefficient), \mathbf{g} is the gravity vector, and $\xi_p, l, X_p, c_\beta, c_D$, are intermediate variables. This formula is used when the **Pressure-gradient formulation** is chosen and it uses the pressure gradient at the wall. By default, the **Velocity formulation** is activated and the corresponding formula is:

$$y_{ps} = \tilde{l} (e^{\xi_p} - 1), \quad \xi_p = \frac{d_w}{l}, \quad \tilde{l} = \frac{l_{pore}}{\sqrt{1 + 2c_\beta}},$$

$$c_\beta = \left[\left(\frac{\beta_{ND} \kappa |\mathbf{u}_{slip}|}{\mu} \frac{l_{pore}}{d_w} \right)^2 / 2 \right]^{1/3}$$

Although this formulation is an approximation, since it uses the slip velocity at the wall to reconstruct the pressure gradient, it is rather accurate. Moreover, the influence of the convective terms is partially accounted for in this formulation.

SLIDING WALL

The sliding wall option is appropriate if the wall behaves like a conveyor belt; that is, the surface is sliding in its tangential direction. The wall does not have to actually move in the coordinate system.

- In 2D, the tangential direction is unambiguously defined by the direction of the boundary, but the situation becomes more complicated in 3D. For this reason, this boundary condition has slightly different definitions in the different space dimensions.
- For 2D and 2D axisymmetric components, the velocity is given as a scalar U_w and the condition prescribes

$$\mathbf{u} \cdot \mathbf{n} = 0, \quad \mathbf{u} \cdot \mathbf{t} = U_w$$

where $\mathbf{t} = (n_y, -n_x)$ for 2D and $\mathbf{t} = (n_z, -n_r)$ for axial symmetry.

- For 3D components, the velocity is set equal to a given vector \mathbf{u}_w projected onto the boundary plane:

$$\mathbf{u} = \frac{\mathbf{u}_w - (\mathbf{n} \cdot \mathbf{u}_w)\mathbf{n}}{\|\mathbf{u}_w - (\mathbf{n} \cdot \mathbf{u}_w)\mathbf{n}\|} \|\mathbf{u}_w\|$$

The normalization makes \mathbf{u} have the same magnitude as \mathbf{u}_w even if \mathbf{u}_w is not exactly parallel to the wall.

Navier Slip

This boundary condition enforces no-penetration at the wall, $\mathbf{u} \cdot \mathbf{n}_{\text{wall}} = 0$, and adds a tangential stress

$$\mathbf{K}_{\text{nt}} = -\frac{\mu}{\beta} \mathbf{u}_{\text{slip}}$$

where $\mathbf{K}_{\text{nt}} = \mathbf{K}_n - (\mathbf{K}_n \cdot \mathbf{n}_{\text{wall}})\mathbf{n}_{\text{wall}}$, $\mathbf{K}_n = \mathbf{K}\mathbf{n}_{\text{wall}}$, and \mathbf{K} is the viscous stress tensor. β is a slip length, and $\mathbf{u}_{\text{slip}} = \mathbf{u} - (\mathbf{u} \cdot \mathbf{n}_{\text{wall}})\mathbf{n}_{\text{wall}}$ is the velocity tangential to the wall. The boundary condition does not set the tangential velocity component to zero; however, the extrapolated tangential velocity component is 0 at a distance β outside the wall.

The **Slip Length** setting is per default set to **Factor of minimum element length**. The slip length β is then defined as $\beta = f_h h_{\text{min}}$, where h_{min} is the smallest element side

(corresponds to the element size in the wall normal direction for boundary layer elements) and f_h is a user input.

In cases where the wall movement is nonzero, **Account for the translational wall velocity in the friction force** may be selected to use $\mathbf{u} - \mathbf{u}_{\text{bnd}} - ((\mathbf{u} - \mathbf{u}_{\text{bnd}}) \cdot \mathbf{n}_{\text{wall}})\mathbf{n}_{\text{wall}}$ instead of \mathbf{u}_{slip} in the friction force. Then, the extrapolated tangential velocity component is \mathbf{u}_{bnd} at a distance β outside of the wall. Note that the **Velocity of sliding wall** \mathbf{u}_w is always accounted for in the friction force.

The Navier Slip option is not available when selecting a turbulence model.

CONSTRAINT SETTINGS

The wall feature uses three different techniques to constraint the velocity field:

- **Pointwise constraints** is the standard technique to enforce strong constraints in the finite element method. The desired value of the velocity is prescribed at each node point in the mesh. Since the constraint is enforced locally at each node, only local values are affected by the constraint and the constraints are independent of each other. The solvers can therefore eliminate both the constrained degrees of freedom and the constraint force terms, effectively reducing the number of degrees of freedom being solved for.

The main advantage of pointwise constraints is that they enforce the constraint exactly pointwise. This means that they do not introduce any leakage of the velocity across the wall, unless specified. The main disadvantage of pointwise constraints is that they introduce locking effects when trying to impose a no-penetration condition for the velocity, $\mathbf{u} \cdot \mathbf{n} = 0$, on curved walls or walls with sharp corners.

- **Weak constraints** is an alternative method to prescribe the velocity. It consists on enforcing the boundary condition for the velocity via *Lagrange multipliers*. Their main advantage is that the Lagrange multiplier can provide an accurate representation of the reaction flux at the wall. Their main disadvantage is that they introduce extra unknowns, and are usually difficult to combine with other constraint methods on adjacent boundaries. Moreover, they may require extra constraints for the Lagrange multipliers. For more information, see [Weak Constraints](#) in the *COMSOL Multiphysics Reference Manual*.
- **Nitsche constraints** use a numerical flux to prescribe the velocity at the wall. They impose the constraint in an integral sense rather than pointwise, and do not suffer from the locking effects introduced by pointwise constraints when trying to prescribe a no penetration condition for the velocity. They are also better behaved when prescribing nonlinear constraints. Their main disadvantage is that the

constraint is only imposed approximately, and may produce small leaks. For more information, see [Nitsche Constraints](#).

The following combination of Constraint techniques can be selected in the **Constraint Setting** sections of Wall boundary conditions:

- **Automatic** (default) use different constraint methods depending on whether only the normal component of the velocity is prescribed, such as in the no penetration condition, $\mathbf{u} \cdot \mathbf{n} = 0$, imposed, for example, in Slip walls or No Slip walls using Wall Functions or Automatic Wall Treatment, or both tangential and normal components are prescribed, as is the case of No Slip walls in laminar flow.
Nitsche constraints are used to impose the no penetration condition for Slip walls. When a No Slip condition is prescribed, pointwise constraints are used except for moving walls where Nitsche constraints are used.
- **Pointwise constraints.**
- **Nitsche constraints.**
- **Weak constraints.** They are not available on Interior Walls.
- **Mixed constraints.** This option is only available when both the tangential and normal components of the velocity need to be prescribed. The velocity on the wall normal direction is imposed via pointwise constraints. The constraint for the tangential directions is relaxed, and Nitsche constraints are used instead. This provides improved accuracy and performance when working with coarse boundary layer meshes. For more information, see [Ref. 18](#).

Prescribing Inlet and Outlet Conditions

The Navier–Stokes equations can show large variations in mathematical behavior, ranging from almost completely elliptic to almost completely hyperbolic. This has implications when it comes to prescribing admissible boundary conditions. There is also a discrepancy between mathematically valid boundary conditions and practically useful boundary conditions. See [Inlet](#) and [Outlet](#) for the node settings.

INLET CONDITIONS

An inlet requires specification of the velocity components. The most robust way to do this is to prescribe a velocity field using a Velocity condition.

A common alternative to prescribing the complete velocity field is to prescribe a pressure and all but one velocity component. The pressure cannot be specified

pointwise because this is mathematically over-constraining. Instead the pressure can be specified via a stress condition:

$$-p + 2\mu \frac{\partial u_n}{\partial n} = F_n \quad (7-34)$$

where $\partial u_n / \partial n$ is the normal derivative of the normal velocity component.

Equation 7-34 is prescribed by the Pressure condition in the Inlet and Outlet features and the Normal stress condition in the Open Boundary and Boundary Stress features. Equation 7-34 is mathematically more stringent compared to specifying the pressure pointwise and at the same time cannot guarantee that p obtains the desired value. In practice, p is close to F_n , except for low Reynolds number flows where viscous effects are the only effects that balance the pressure. In addition to Equation 7-34, all but one velocity component must be specified. For low Reynolds numbers, this can be specified by a vanishing tangential stress condition:

$$\mu \frac{\partial u_t}{\partial n} = 0$$

which is what the Normal stress condition does. Vanishing tangential stress becomes a less well-posed inlet condition as the Reynolds number increases. The Pressure condition in the Inlet feature therefore requires a flow direction to be prescribed, which provides a well-posed condition independent of Reynolds number.

OUTLET CONDITIONS

The most common approach is to prescribe a pressure via a normal stress condition on the outlet. This is often accompanied by a vanishing tangential stress condition:

$$\mu \frac{\partial u_t}{\partial n} = 0$$

where $\partial u_t / \partial n$ is the normal derivative of the tangential velocity field. It is also possible to prescribe u_t to be zero. The latter option should be used with care since it can have a significant effect on the upstream solution.

The elliptic character of the Navier–Stokes equations mathematically permits specifying a complete velocity field at an outlet. This can, however, be difficult to apply in practice. The reason being that it is hard to prescribe the outlet velocity so that it is consistent with the interior solution at each point. The adjustment to the specified velocity then occurs across an outlet boundary layer. The thickness of this boundary

layer depends on the Reynolds number; the higher the Reynolds number, the thinner the boundary layer.

ALTERNATIVE FORMULATIONS

COMSOL provides several specialized boundary conditions that either provide detailed control over the flow at the boundary or that simulate specific devices. In practice they often prescribe a velocity or a pressure but calculate the prescribed values using, for example, ODEs.



Normal Stress Boundary Condition

Mass Flow

The **Mass flow** boundary condition constrains the mass flowing into the domain across an inlet boundary. The mass flow can be specified in a number of ways.

POINTWISE MASS FLUX

The pointwise mass flux sets the velocity at the boundary to:

$$\mathbf{u} = -\frac{m_f}{\rho} \mathbf{n}$$

where m_f is the normal mass flux and ρ is the density.

MASS FLOW RATE

The mass flow rate boundary condition sets the total mass flow through the boundary according to:

$$-\int_{\partial\Omega} d_{bc} \rho (\mathbf{u} \cdot \mathbf{n}) dS = m$$

where d_{bc} (only present in the 2D Cartesian axis system) is the boundary thickness normal to the fluid-flow domain and m is the total mass flow rate.

In addition to the constraint on the total flow across the boundary, the tangential velocity components are set to zero on the boundary

$$\mathbf{u} \times \mathbf{n} = \mathbf{0} \tag{7-35}$$

STANDARD FLOW RATE

The standard flow rate boundary condition specifies the mass flow as a standard volumetric flow rate. The mass flow through the boundary is set by the equation:

$$-\int_{\partial\Omega} d_{bc} \frac{\rho}{\rho_{st}} (\mathbf{u} \cdot \mathbf{n}) dS = Q_{sv}$$

where d_{bc} (only present in the 2D component Cartesian axis system) is the boundary thickness normal to the fluid-flow domain, ρ_{st} is the standard density, and Q_{sv} is the standard flow rate. The standard density is defined by one of the following equations:

$$\rho_{st} = \frac{M_n}{V_n}$$
$$\rho_{st} = \frac{p_{st} M_n}{RT_{st}}$$

where M_n is the mean molar mass of the fluid, V_n is the standard molar volume, p_{st} is the standard pressure, R is the universal molar gas constant, and T_{st} is the standard temperature.

Equation 7-35 or Equation 7-36 is also enforced for compressible and incompressible flow, respectively, ensuring that the normal component of the viscous stress and the tangential component of the velocity are zero at the boundary.

Fully Developed Flow (Inlet)

The **Fully developed flow** boundary condition can be understood from the following figure:

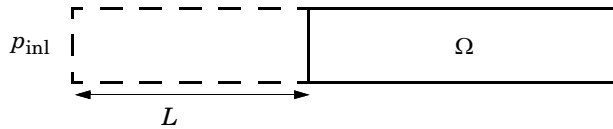

The flow to the domain Ω is assumed to enter through a straight channel of length L . The channel is a virtual extrusion of the inlet cross section and a pressure constant pressure P_{inl} is applied on the inlet of the virtual channel.

The Fully Developed Flow boundary condition prescribes that the tangential flow component on the boundary is zero:

$$\mathbf{u} - (\mathbf{u} \cdot \mathbf{n})\mathbf{n} = \mathbf{0}$$

The momentum equation for a fully developed flow in the virtual extrusion of the inlet cross section can then be projected onto the inlet boundary with the following weak equation as the result:

$$\int_{\partial\Omega} \left(\left(L \left(-\mu(\nabla_{\mathbf{t}}\mathbf{u} + (\nabla_{\mathbf{t}}\mathbf{u})^T) + \frac{(p + P_{\text{inl}})\mathbf{I}}{2} \right) : (\nabla_{\mathbf{t}}\hat{\mathbf{u}}) \right) - P_{\text{inl}}(\mathbf{n} \cdot \hat{\mathbf{u}}) \right)$$

The exact value of L is somewhat arbitrary as long as it is not too high or too low. L is therefore set to ten times the inlet edge length in 2D and to ten times the square root of the inlet area in 2D axisymmetry and in 3D.

The fact that the velocity profile is not prescribed, but rather the solution of a projected weak contribution, means that the actual velocity profile that is obtained on the inlet can deviate from the analytical fully developed flow profile (in cases such an analytical solution exists) if required by the solution inside the computational domain, Ω . This is most notably if the flow is strongly curved just downstream of the inlet. This can, for example, be the case if an object is positioned just downstream of the inlet or if the adjacent boundaries are not orthogonal to the inlet. The analytical solution can in these cases be recovered by including a little bit of the inlet channel in the computational domain.

The inlet pressure, P_{inl} , must be solved for and the its equation is a discrete algebraic equation (DAE) for P_{inl} . When, for example, the average velocity is specified, the DAE reads

$$(\langle \mathbf{u} \cdot \mathbf{n} \rangle + U_{\text{av}})\hat{P}_{\text{inl}}$$

where $\langle \cdot \rangle$ denotes the average over the inlet. Since the equation for P_{inl} is a DAE (the equation for P_{inl} does not contain P_{inl}), it must be solved coupled to Navier–Stokes and it must be treated by a Vanka presmoothing and postsmoothing if iterative solvers are used.

The boundary conditions for the virtual inlet channel are inherited from the boundaries adjacent to the inlet channel. Virtual boundaries adjacent to walls (except slip walls) are treated as no-slip walls. Virtual boundaries adjacent to any other type of boundary are treated as slip-walls (or equivalently as symmetry boundaries). So in the figure above, if the lower boundary of Ω is a no-slip wall and the top boundary is a symmetry boundary, the lower boundary of the virtually extruded channel becomes a no-slip wall and the upper boundary becomes a symmetry boundary.

Algebraic turbulence models need to additional equations or constraints. For all other turbulence models, their weak equations in the virtual inlet channel are projected onto the inlet of the computational domain. The projections are regularized to prevent the production to fall to zero, so the solutions of the projects can show slight deviation from the correct solutions close to no-slip walls.

Fully Developed Flow (Outlet)

The **Fully developed flow** boundary condition can be understood from the following figure:

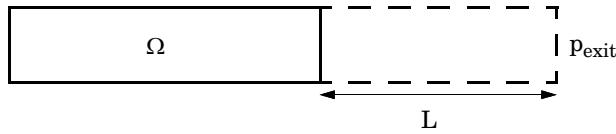

The flow to the domain Ω is assumed to enter through a straight channel of length L . The channel is a virtual extrusion of the inlet cross section and a pressure constant pressure P_{exit} is applied on the inlet of the virtual channel.

The Fully Developed Flow boundary condition prescribes that the tangential flow component on the boundary is zero:

$$\mathbf{u} - (\mathbf{u} \cdot \mathbf{n})\mathbf{n} = \mathbf{0}$$

The momentum equation for a fully developed flow in the virtual extrusion of the inlet cross section can then be projected onto the inlet boundary with the following weak equation as the result:

$$\int_{\partial\Omega} \left(\left(L \left(-\mu (\nabla_{\mathbf{t}} \mathbf{u} + (\nabla_{\mathbf{t}} \mathbf{u})^T) + \frac{(p + P_{\text{exit}})}{2} \mathbf{I} \right) : (\nabla_{\mathbf{t}} \hat{\mathbf{u}}) \right) - P_{\text{exit}} (\mathbf{n} \cdot \hat{\mathbf{u}}) \right)$$

The exact value of L is somewhat arbitrary as long as it is not too high or too low. L is therefore set to ten times the inlet edge length in 2D and to ten times the square root of the inlet area in 2D axisymmetry and in 3D.

The fact that the velocity profile is not prescribed, but rather the solution of a projected weak contribution, means that the actual velocity profile that is obtained on the outlet can deviate from the analytical fully developed flow profile (in cases such an analytical solution exists) if required by the solution inside the computational domain, Ω . The inlet pressure, P_{exit} , must be solved for and the its equation is a discrete algebraic

equation (DAE) for P_{exit} . When, for example, the average velocity is specified, the DAE reads

$$(\langle \mathbf{u} \cdot \mathbf{n} \rangle + U_{\text{av}}) \hat{P}_{\text{exit}}$$

where $\langle \cdot \rangle$ denotes the average over the inlet. Since the equation for P_{ext} is a DAE, it must be solved coupled to Navier–Stokes and it must be treated by a Vanka presmoothing and postsmoothing if iterative solvers are used.

The boundary conditions for the virtual outlet channel are inherited from the boundaries adjacent to the outlet channel. Virtual boundaries adjacent to walls (except slip walls) are treated as no-slip walls. Virtual boundaries adjacent to any other type of boundary are treated as slip-walls (or equivalently as symmetry boundaries).

No Viscous Stress

For this module, and in addition to the Pressure, No Viscous Stress boundary condition, the viscous stress condition sets the viscous stress to zero:

$$\left(\mu(\nabla \mathbf{u} + (\nabla \mathbf{u})^T) - \frac{2}{3} \mu(\nabla \cdot \mathbf{u}) \mathbf{I} \right) \mathbf{n} = \mathbf{0}$$

$$(\mu(\nabla \mathbf{u} + (\nabla \mathbf{u})^T)) \mathbf{n} = \mathbf{0}$$

using the compressible/weakly compressible and the incompressible formulation, respectively.

The condition is not a sufficient outlet condition since it lacks information about the outlet pressure. It must hence be combined with pressure point constraints on one or several points or lines surrounding the outlet.

This boundary condition is numerically the least stable outlet condition, but can still be beneficial if the outlet pressure is nonconstant due to, for example, a nonlinear volume force.

Normal Stress Boundary Condition

The total stress on the boundary is set equal to a stress vector of magnitude f_0 , oriented in the negative normal direction:

$$\left(-p \mathbf{I} + \left(\mu(\nabla \mathbf{u} + (\nabla \mathbf{u})^T) - \frac{2}{3} \mu(\nabla \cdot \mathbf{u}) \mathbf{I} \right) \right) \mathbf{n} = -f_0 \mathbf{n}$$

$$(-p\mathbf{I} + \mu(\nabla\mathbf{u} + (\nabla\mathbf{u})^T))\mathbf{n} = -f_0\mathbf{n}$$

using the compressible/weakly compressible and the incompressible formulation, respectively.

This implies that the total stress in the tangential direction is zero. This boundary condition implicitly sets a constraint on the pressure which for 2D flows is

$$p = 2\mu\frac{\partial u_n}{\partial n} + f_0 \quad (7-36)$$

If $\partial u_n/\partial n$ is small, Equation 7-36 states that $p \approx f_0$.

The Normal Stress condition is the mathematically correct version of the [Pressure Conditions](#) condition (Ref. 4), but it is numerically less stable.

Pressure Boundary Condition

For single-phase flow, a mathematically correct natural boundary condition for outlets is

$$\left(-p\mathbf{I} + \mu(\nabla\mathbf{u} + (\nabla\mathbf{u})^T) - \frac{2}{3}\mu(\nabla \cdot \mathbf{u})\mathbf{I}\right)\mathbf{n} = -p_0\mathbf{n} \quad (7-37)$$

$$(-p\mathbf{I} + \mu(\nabla\mathbf{u} + (\nabla\mathbf{u})^T))\mathbf{n} = -p_0\mathbf{n} \quad (7-38)$$

using the compressible/weakly compressible and the incompressible formulation, respectively.

This is a normal stress condition together with a no-tangential-stress condition. When $\mu > 0$, Equation 7-37 or Equation 7-38 can be supplemented with a tangential velocity condition

$$\mathbf{u} \cdot \mathbf{t} = 0 \quad (7-39)$$

If so, the no-tangential-stress condition is overridden. An issue with Equation 7-37 or Equation 7-38 is that it does not strongly enforce unidirectional flow on the boundary. If the prescribed pressure on an outlet is too high, parts of the outlet can actually have inflow. This is not as much of an issue for the Navier–Stokes equations as it is an issue for scalar transport equations solved along with the Navier–Stokes equations. Hence, when applying the **Pressure** boundary condition at an outlet or inlet you can further constrain the flow. With the **Suppress backflow** option

$$\begin{aligned}
& \left(-p\mathbf{I} + \mu(\nabla\mathbf{u} + (\nabla\mathbf{u})^T) - \frac{2}{3}\mu(\nabla \cdot \mathbf{u})\mathbf{I} \right) \mathbf{n} = -\hat{p}_0\mathbf{n} \\
& \left(-p\mathbf{I} + \mu(\nabla\mathbf{u} + (\nabla\mathbf{u})^T) \right) \mathbf{n} = -\hat{p}_0\mathbf{n} \\
& \hat{p}_0 \leq p_0
\end{aligned} \tag{7-40}$$

the normal stress is adjusted to keep

$$\mathbf{u} \cdot \mathbf{n} \geq 0 \tag{7-41}$$

Equation 7-40 effectively means that the prescribed pressure is p_0 if $\mathbf{u} \cdot \mathbf{n} \geq 0$, but smaller at locations where $\mathbf{u} \cdot \mathbf{n} < 0$. This means that Equation 7-40 does not completely prevent backflow, but the backflow is substantially reduced. Backflow is suppressed also when external forces are acting on the fluid, provided the magnitude of these forces are of the same order as the dynamic pressure at the outlet.

A pressure condition can also be applied at an inlet. In this case, either the normal stress is prescribed

$$\begin{aligned}
& \mathbf{n}^T \left(-p\mathbf{I} + \mu(\nabla\mathbf{u} + (\nabla\mathbf{u})^T) - \frac{2}{3}\mu(\nabla \cdot \mathbf{u})\mathbf{I} \right) \mathbf{n} = -\hat{p}_0 \\
& \mathbf{n}^T \left(-p\mathbf{I} + \mu(\nabla\mathbf{u} + (\nabla\mathbf{u})^T) \right) \mathbf{n} = -\hat{p}_0 \\
& \hat{p}_0 \geq p_0
\end{aligned} \tag{7-42}$$

together with the tangential condition in Equation 7-39, or, a general flow direction is prescribed.

$$\begin{aligned}
& \mathbf{r}_{\mathbf{u}}^T \left(-p\mathbf{I} + \mu(\nabla\mathbf{u} + (\nabla\mathbf{u})^T) - \frac{2}{3}\mu(\nabla \cdot \mathbf{u})\mathbf{I} \right) \mathbf{n} = -\hat{p}_0(\mathbf{r}_{\mathbf{u}} \cdot \mathbf{n}) \\
& \mathbf{r}_{\mathbf{u}}^T \left(-p\mathbf{I} + \mu(\nabla\mathbf{u} + (\nabla\mathbf{u})^T) \right) \mathbf{n} = -\hat{p}_0(\mathbf{r}_{\mathbf{u}} \cdot \mathbf{n}) \\
& \hat{p}_0 \geq p_0 \\
& \mathbf{u} - (\mathbf{u} \cdot \mathbf{r}_{\mathbf{u}})\mathbf{r}_{\mathbf{u}} = \mathbf{0}, \quad \mathbf{r}_{\mathbf{u}} = \frac{\mathbf{d}_{\mathbf{u}}}{\|\mathbf{d}_{\mathbf{u}}\|}
\end{aligned} \tag{7-43}$$

The “>” option is used with suppress backflow to have $\mathbf{u} \cdot \mathbf{n} \leq 0$ or $\mathbf{u} \cdot \mathbf{r}_{\mathbf{u}} \geq 0$.

For incompressible single-phase flow, it is also allowed to specify the total pressure, p_{tot} , instead of the static pressure, p_{stat} , on inlet and outlet boundaries. It is more

useful, for example, in pump applications. The pressure is then prescribed at the boundaries using Bernoulli's principle,

$$p = p_{\text{stat}} = p_{\text{tot}} - \frac{1}{2}\rho|\mathbf{u}|^2 \quad (7-44)$$

The equation is imposed with two options: **Average** and **Pointwise**.

In the first option, p_{stat} is prescribed by:

$$\mathbf{n}^T(-p\mathbf{I} + \mu(\nabla\mathbf{u} + (\nabla\mathbf{u})^T))\mathbf{n} = \mathbf{n}^T(-p_{\text{stat}}\mathbf{I} + \mu(\nabla\mathbf{u} + (\nabla\mathbf{u})^T))\mathbf{n} \quad (7-45)$$

where p_{tot} and $|\mathbf{u}|^2$ are averaged over the boundaries using the aveop operator:

$$p_{\text{stat}} = \text{aveop}(p_{\text{tot}}) - \frac{1}{2}\rho \cdot \text{aveop}(|\mathbf{u}|^2)$$

For the second option, Equation 7-44 is prescribed pointwise.

See [Inlet](#), [Outlet](#), [Open Boundary](#), and [No Viscous Stress](#) for the individual node settings. Note that some modules have additional theory sections describing options available with that module.

Porous Interface

This condition properly accounts for a sudden jump in porosity ε_p across boundary between different domains, giving the corresponding jump in stress across the interface. The emergence of a boundary layer on the upstream side of the interface is also revealed, which provides modifications to the behavior of the tangential velocity near the interface. The feature helps to avoid the need to add a very thin transition region, in which $\varepsilon_{p,\text{upstream}}$ changes to $\varepsilon_{p,\text{downstream}}$ continuously, while solving the Brinkman equation in such situations. Below, ‘-’ and ‘+’ (used as subscripts and superscripts) refer to the upstream and downstream side of the interface, respectively.

Whatever the option for **Continuity conditions** is chosen, the velocity conditions are

$$[\rho(\mathbf{u} \cdot \mathbf{n})]_{-}^{+} = 0, \quad \mathbf{u}_t|_{-}^{+} \equiv [\mathbf{u} - (\mathbf{u} \cdot \mathbf{n})\mathbf{n}]_{-}^{+} = 0$$

That is, the mass flux and tangential velocity across the interface are constant, and \mathbf{n} is assumed to be a normal pointing from ‘-’ to ‘+’. **Velocity and stress** option just imposes usual stress continuity adding a correction for a possible jump in density:

$$\left[p\mathbf{n} - \mathbf{K}\mathbf{n} + \rho(\mathbf{u} \cdot \mathbf{n}) \left(\left[\frac{1}{\varepsilon_p} \right]_{\text{av}} \right)^2 \mathbf{u} \right]_{-}^{+} = 0$$

The option **Velocity and porosity-corrected stress** (default) adds a contribution due to the inertial term, which is non-trivial (gives non-zero effect) when ε_p jumps across the interface:

$$\left[p\mathbf{n} - \mathbf{K}\mathbf{n} + \rho(\mathbf{u} \cdot \mathbf{n}) \left(\left[\frac{1}{\varepsilon_p} \right]_{\text{av}} \right)^2 \mathbf{u} + \rho(\mathbf{u} \cdot \mathbf{n}) \left(\frac{1}{2\varepsilon_p^2} \right) \mathbf{u}_{\text{av}} \right]_{-}^{+} = 0$$

Notice that $\left[\frac{1}{\varepsilon_p} \right]_{\text{av}} = \left(\left[\frac{1}{\varepsilon_p} \right]_{-} + \left[\frac{1}{\varepsilon_p} \right]_{+} \right) / 2$, $\mathbf{u}_{\text{av}} = (\mathbf{u}_{-} + \mathbf{u}_{+}) / 2$ and so on.

Then, the **Velocity and porosity-corrected stress with loss** option has a ‘pressure loss’ term:

$$\left[p\mathbf{n} - \mathbf{K}\mathbf{n} + \rho(\mathbf{u} \cdot \mathbf{n}) \left(\left[\frac{1}{\varepsilon_p} \right]_{\text{av}} \right)^2 \mathbf{u} + \rho(\mathbf{u} \cdot \mathbf{n}) \left(\frac{1}{2\varepsilon_p^2} \right) \mathbf{u}_{\text{av}} \right]_{-}^{+} + p^{(\text{loss})} \mathbf{n} = 0$$

This loss occurs in the downstream direction. Its mechanism is similar to the mechanism of common engineering ‘total pressure loss’. Indeed, ‘expansion’ and ‘contraction’ across the interface experienced by the flow on the microscopic level (due to increasing or decreasing porosity, ε_p , respectively), are roughly equivalent to expansion and contraction of flow in a pipe with geometrical variations. Accordingly, it is assumed that only the normal velocity component is responsible for the loss. In the case of normal flow and negligible viscous term the pipe-analogy is quite exact.

Subsequently, **Pressure loss model** should be specified. Choosing **User-defined loss coefficients** requires values of **Expansion loss coefficient** and **Contraction loss coefficient** ($K_{\text{exp}} = 1$ and $K_{\text{contr}} = 0.5$ are default values). The resulting losses on the ‘expansion’ and ‘contraction’ boundaries are:

$$p^{(\text{loss,expansion})} = K_{\text{exp}} \left(\left(\frac{\rho(\mathbf{u} \cdot \mathbf{n})^2}{2\varepsilon_p^2} \right)_- \right),$$

$$p^{(\text{loss,contraction})} = K_{\text{contr}} \left(\left(\frac{\rho(\mathbf{u} \cdot \mathbf{n})^2}{2\varepsilon_p^2} \right)_+ \right)$$

Borda–Carnot option results in the following losses:

$$p^{(\text{loss,expansion})} = \frac{\rho_{\text{av}}}{2} \left(\left[\frac{(\mathbf{u} \cdot \mathbf{n})}{\varepsilon_p} \right]_+ - \left[\frac{(\mathbf{u} \cdot \mathbf{n})}{\varepsilon_p} \right]_- \right)^2,$$

$$p^{(\text{loss,contraction})} = \frac{1}{2} \left(\frac{\rho(\mathbf{u} \cdot \mathbf{n})^2}{\varepsilon_p^2} \right)_+ \left(\frac{1}{c_{\text{vc}}} - 1 \right)^2$$

and requires to choose **Vena contracta model**. The **User defined** option asks for value of **Vena contracta coefficient** ($c_{\text{vc}} = 0.5$ by default). **Weisbach** option computes the coefficient based on the ratio of porosities across the interface:

$$c_{\text{vc}} = c_{\text{vc,ll}} + (1 - c_{\text{vc,ll}}) \left(\frac{\varepsilon_{\text{p,+}}}{\varepsilon_{\text{p,-}}} \right)^{n_{\text{vc}}}$$

and requires inputs for **Lower limit** and **Exponent** ($c_{\text{vc,ll}} = 0.63$ and $n_{\text{vc}} = 3$ are default values).

Although the velocity conditions formally look the same for all **Continuity conditions** options, the latter two (containing the inertial correction due to the porosity jump) lead to an extra non-trivial effect. Namely, the tangential velocity exponentially evolves over a boundary layer formed on the upstream side of the interface boundary. This boundary layer has a characteristic length equal to

$$l_- = \frac{\mu \varepsilon_{\text{p,-}}}{\rho(\mathbf{u} \cdot \mathbf{n})}$$

The ratio of the tangential velocities right after the interface (‘downstream’) and outside the boundary layer (‘upstream infinity’) is

$$\frac{|\mathbf{u}_{\text{t,+}}|}{|\mathbf{u}_{\text{t,upstream infinity}}|} = \frac{2\varepsilon_{\text{p,+}}/\varepsilon_{\text{p,-}}}{\varepsilon_{\text{p,+}}/\varepsilon_{\text{p,-}} + \varepsilon_{\text{p,-}}/\varepsilon_{\text{p,+}}}$$

In terms of the interstitial velocity, $\mathbf{u}^{(i)} = \mathbf{u}/\varepsilon_p$, this results in:

$$\frac{|\mathbf{u}_{t,+}^{(i)}|}{|\mathbf{u}_{t,\text{upstream infinity}}^{(i)}|} = \frac{2}{\varepsilon_{p,+}/\varepsilon_{p,-} + \varepsilon_{p,-}/\varepsilon_{p,+}} \leq 1$$

Obviously, tangential component of the interstitial kinetic energy is lost across the interface. For low viscosity and high normal-flow component, when l_u is much lower than l_{geom} (the characteristic geometry length) there are apparent variations in \mathbf{u}_t and $\mathbf{u}_t^{(i)}$ in a thin boundary layer on the upstream side of the interface. However, for the cases with high viscosity or nearly interface-parallel flow, l_u is much larger than l_{geom} , and any variations in \mathbf{u}_t and $\mathbf{u}_t^{(i)}$ are virtually invisible.

Notice that the feature does not take into account possible underresolved porous scale, as is described in [Theory for the Free and Porous Media Flow, Darcy Interface](#).

Mass Sources for Fluid Flow

There are two types of mass sources in a Single-Phase Flow interface: point sources and line sources.



These features require at least one of the following licenses: Battery Design Module, CFD Module, Chemical Reaction Engineering Module, Corrosion Module, Electrochemistry Module, Electrodeposition Module, Fuel Cell & Electrolyzer Module, Microfluidics Module, Pipe Flow Module, Polymer Flow Module, or Subsurface Flow Module.

POINT SOURCE

A point source is theoretically formed by taking a mass injection/ejection, \dot{Q} (SI unit: $\text{kg}/(\text{m}^3 \cdot \text{s})$), in a small volume δV and then letting the size of the volume tend to zero while keeping the total mass flux constant. Given a point source strength, \dot{q}_p (SI unit: kg/s), this can be expressed as

$$\lim_{\delta V \rightarrow 0} \int_{\delta V} \dot{Q} = \dot{q}_p \quad (7-46)$$

An alternative way to form a point source/sink is to assume that mass is injected/extracted through the surface of a small object. Letting the object surface area tend to zero while keeping the mass flux constant, results in the same point source. For this alternative approach, effects resulting from the physical object volume, such as drag and fluid displacement, need to be neglected.

The weak contribution

$$\dot{q}_p \text{test}(p)$$

is added to a point in the geometry. As can be seen from Equation 7-46, \dot{Q} must tend to plus or minus infinity as δV tends to zero. This means that in theory the pressure also tends to plus or minus infinity.

Observe that “point” refers to the physical representation of the source. A point source can therefore only be added to points in 3D components and to points on the symmetry axis in 2D axisymmetry components. Other geometrical points in 2D components represent physical lines.

The finite element representation of Equation 7-46 corresponds to a finite pressure in a point with the effect of the point source spread out over a region around the point. The size of the region depends on the mesh and on the strength of the source. A finer mesh gives a smaller affected region, but also a more extreme pressure value. It is important not to mesh too finely around a point source since the resulting pressure can result in unphysical values for the density, for example. It can also have a negative effect on the condition number for the equation system.

LINE SOURCE

A line source can theoretically be formed by assuming a source of strength \dot{Q} (SI unit: $\text{kg}/(\text{m}^3 \cdot \text{s})$), located within a tube with cross-sectional area δS and then letting δS tend to zero, while keeping the total mass flux per unit length constant. Given a line source strength, \dot{q}_l (SI unit: $\text{kg}/(\text{m} \cdot \text{s})$), this can be expressed as

$$\lim_{\delta S \rightarrow 0} \int_{\delta S} \dot{Q} = \dot{q}_l \quad (7-47)$$

As in the point source case, an alternative approach is to assume that mass is injected/extracted through the surface of a small object. This results in the same mass source, but requires that effects on the fluid resulting from the physical object volume are neglected.

The weak contribution

$$\dot{q}_l \text{test}(p)$$

is added to lines in 3D or to points in 2D (which represent cut-through views of lines). Line sources can also be added to the axisymmetry line in 2D axisymmetry

components. It cannot, however, be added to geometrical lines in 2D because they represent physical planes.

As with a point source, it is important not to mesh too finely around the line source.



For feature node information, see [Line Mass Source](#) and [Point Mass Source](#).



For the Reacting Flow in Porous Media, Diluted Species interface, which is available with the CFD Module, Chemical Reaction Engineering Module, or Battery Design Module, these shared physics nodes are renamed as follows:

- The **Line Mass Source** node is available as two nodes, one for the fluid flow (**Fluid Line Source**) and one for the species (**Species Line Source**).
- The **Point Mass Source** node is available as two nodes, one for the fluid flow (**Fluid Point Source**) and one for the species (**Species Point Source**).

Numerical Stability — Stabilization Techniques for Fluid Flow

The momentum equation ([Equation 7-28](#) or [Equation 7-30](#)) is a (nonlinear) convection-diffusion equation. Such equations can easily become unstable if discretized using the Galerkin finite element method. Stabilized finite element methods are usually necessary in order to obtain physical solutions. The stabilization settings are found in the main Fluid Flow interface features. To display this section, click the **Show More Options** button () and select **Stabilization** in the **Show More Options** dialog box.

There are three types of stabilization methods available for Navier–Stokes — *streamline diffusion*, *crosswind diffusion*, and *isotropic diffusion*. Streamline diffusion and crosswind diffusion are consistent stabilization methods, whereas isotropic diffusion is an inconsistent stabilization method.

For optimal functionality, the exact weak formulations of and constants in the streamline diffusion and crosswind diffusion methods depend on the order of the shape functions (basis functions) for the elements. The values of constants in the streamline diffusion and crosswind diffusion methods follow [Ref. 5](#) and [Ref. 6](#).

STREAMLINE DIFFUSION

For strongly coupled systems of equations, the streamline diffusion method must be applied to the system as a whole rather than to each equation separately. These ideas were first explored by Hughes and Mallet (Ref. 8) and were later extended to Galerkin least-squares (GLS) applied to the Navier–Stokes equations (Ref. 9). This is the streamline diffusion formulation that COMSOL Multiphysics supports.

Streamline diffusion is active by default because it is necessary when convection is dominating the flow.

The governing equations for incompressible flow are subject to the Babuška–Brezzi condition, which states that the shape functions (basis functions) for pressure must be of lower order than the shape functions for velocity. If the incompressible Navier–Stokes equations are stabilized by streamline diffusion, it is possible to use equal-order interpolation. Hence, streamline diffusion is necessary when using first-order elements for both velocity and pressure. This applies also if the model is solved using geometric multigrid (either as a solver or as a preconditioner) and at least one multigrid hierarchy level uses linear Lagrange elements.

CROSSWIND DIFFUSION

Crosswind diffusion can also be formulated for systems of equations, and when applied to the Navier–Stokes equations it becomes a shock-capturing operator. COMSOL Multiphysics supports the formulation in Ref. 9 with a shock-capturing viscosity of the Hughes–Mallet type Ref. 8.

Incompressible flows do not contain shock waves, but crosswind diffusion is still useful for introducing extra diffusion in sharp boundary layers and shear layers that otherwise would require a very fine mesh to resolve.

Crosswind diffusion is active by default as it makes it easier to obtain a solution even if the problem is fully resolved by the mesh. Crosswind diffusion also enables the iterative solvers to use inexpensive presmoothers. If crosswind diffusion is deactivated, more expensive preconditioners must be used instead.

STABILIZATION TIME SCALES

The time-scale tensor for time-dependent problems should in theory depend on a time-scale that many references just set to the time-step taken by the time-solver, Δt (see, for example, Ref. 9 and Ref. 10). This simple approach does not, however, necessarily reflect on the actual time-scales in the physics. A typical example is reacting flows where the time step is often guided by fast reactions, while the flow develops relatively slowly. The COMSOL Multiphysics software can therefore replace Δt^2 in the

time-scale tensor with measures of type $(1/(\Delta\tilde{t})^2)^{-1}$, which are calculated from projections of weak expressions in a fashion similar to those in [Ref. 11](#). These measures of the time scale are used when **Use dynamic subgrid time scale** is activated.

The **Limit small time steps effect on stabilization time scale** option can be used to ramp down the time-step contribution in the stabilization when the time step becomes much smaller than the convective and diffusive time scales. This option prevents loss of pressure stabilization at such small time steps.

ISOTROPIC DIFFUSION

Isotropic diffusion adds diffusion to the Navier–Stokes equations. Isotropic diffusion significantly reduces the accuracy of the solution but does a very good job at reducing oscillations. The stability of the continuity equation is not improved.



Numerical Stabilization and Iterative

Solvers for Laminar Flow

The Navier–Stokes equations constitute a nonlinear equation system. A nonlinear solver must hence be applied to solve the problem. The nonlinear solver iterates to reach the final solution. In each iteration, a linearized version of the nonlinear system is solved using a linear solver. In the time-dependent case, a time marching method must also be applied. The default suggestions for each of these solver elements are discussed below.

NONLINEAR SOLVER

The nonlinear solver method depends on if the model solves a stationary or a time-dependent problem.

Stationary Solver

In the stationary case, a fully coupled, damped Newton method is applied. The initial damping factor is low since a full Newton step can be harmful unless the initial values are close to the final solution. The nonlinear solver algorithm automatically regulates the damping factor in order to reach a converged solution.

For advanced models, the automatically damped Newton method might not be robust enough. A pseudo time-stepping algorithm can then be invoked. See [Pseudo Time Stepping for Laminar Flow Models](#).

Time-Dependent Solver

In the time-dependent case, the initial guess for each time step is (loosely speaking) the previous time step, which is a very good initial value for the nonlinear solver. The automatic damping algorithm is then not necessary. The damping factor in the Newton method is instead set to a constant value slightly smaller than one. Also, for the same reason, it suffices to update the Jacobian once per time step.

It is seldom worth the extra computational cost to update the Jacobian more than once per time step. For most models it is more efficient to restrict the maximum time step or possibly lower the damping factor in the Newton method.

LINEAR SOLVER

The linearized Navier–Stokes equation system has saddle point character, unless the density depends on the pressure. This means that the Jacobian matrix has zeros on the diagonal. Even when the density depends on the pressure, the equation system effectively shares many numerical properties with a saddle point system.

For small 2D and 3D models, the default solver suggestion is a direct solver. Direct solvers can handle most nonsingular systems and are very robust and also very fast for small models. Unfortunately, they become slow for large models and their memory requirement scales as somewhere between $N^{1.5}$ and N^2 , where N is the number of degrees of freedom in the model. The default suggestion for large 2D and 3D models is therefore the iterative GMRES solver. The memory requirement for an iterative solver optimally scales as N .

GMRES is accelerated by a multigrid method, per default the smoothed aggregation algebraic multigrid (SAAMG) method. The cost of SAAMG is typically very low compared to the number of GMRES iterations necessary if no multigrid method is used. As the name implies, SAAMG builds its coarser meshes algebraically, so the application requires no additional meshes in order to employ SAAMG. In contrast, the geometric multigrid (GMG) method requires actual meshes. If a sufficient number of multigrid levels can be constructed, GMG is often faster than SAAMG. GMG is also superior for cluster computations and for shared-memory computations with many cores. When the default linear solver is GMRES, an optional, but deactivated, linear solver node is available where GMRES is accelerated by GMG.

Multigrid methods need smoothers, but the saddle point character of the linear system restricts the number of applicable smoothers. The choices are further restricted by the anisotropic meshes frequently encountered in fluid-flow problems. The efficiency of the smoothers is highly dependent on the numerical stabilization. Iterative solvers

perform at their best when both [Streamline Diffusion](#) and [Crosswind Diffusion](#) are active.

The default smoother for P1+P1 elements is SCGS. This is an efficient and robust smoother specially designed to solve saddle point systems on meshes that contain anisotropic elements. The SCGS smoother works well even without crosswind diffusion. SCGS can sometimes work for higher-order elements, especially if **Method** in the SCGS settings is set to **Mesh element lines**. But there is no guarantee for this, so the default smoother for higher order elements is an SOR Line smoother. SOR Line handles mesh anisotropy but does not formally address the saddle point character. It does, however, function in practice provided that streamline diffusion and crosswind diffusion are both active.

A different kind of saddle point character can arise if the equation system contains ODE variables. Some advanced boundary conditions can add equations with such variables. These variables must be treated with the Vanka algorithm. SCGS includes an option to invoke Vanka. Models with higher-order elements must apply SCGS or use the Vanka smoother. The latter is the default suggestion for higher-order elements, but it does not work optimally for anisotropic meshes.

TIME-DEPENDENT SOLVERS

The default time-dependent solver for Navier–Stokes is the BDF method with maximum order set to two. Higher BDF orders are not stable for transport problems in general nor for Navier–Stokes in particular.

BDF methods have been used for a long time and are known for their stability. However, they can have severe damping effects, especially the lower-order methods. Hence, if robustness is not an issue, a model can benefit from using the generalized- α method instead. Generalized- α is a solver that has properties similar to those of the second-order BDF solver but it is much less diffusive.

Both BDF and generalized- α are per default set to automatically adjust the time step. While this works well for many models, extra efficiency and accuracy can often be gained by specifying a maximum time step. It is also often beneficial to specify an initial time step to make the solver progress smoothly in the beginning of the time series.



- [Time-Dependent Solver](#)
 - [Multigrid, Direct, Iterative, SCGS, SOR Line, and Vanka](#)
 - [Stationary Solver](#)
-

Pseudo Time Stepping for Laminar Flow Models

A stationary formulation has per definition no time derivatives and Equation 7-30 reduces to:

$$\rho(\mathbf{u} \cdot \nabla)\mathbf{u} = \nabla \cdot [-p\mathbf{I} + \mu(\nabla\mathbf{u} + (\nabla\mathbf{u})^T)] + \mathbf{F} \quad (7-48)$$

Solving Equation 7-48 requires a starting guess that is close enough to the final solution. If no such guess is at hand, the fully transient problem can be solved instead. This is, however, a rather costly approach in terms of computational time. An intermediate approach is to add a fictitious time derivative to Equation 7-48:

$$\rho \frac{\mathbf{u} - \text{nojac}(\mathbf{u})}{\Delta\tilde{t}} + \rho(\mathbf{u} \cdot \nabla)\mathbf{u} = \nabla \cdot [-p\mathbf{I} + \mu(\nabla\mathbf{u} + (\nabla\mathbf{u})^T)] + \mathbf{F}$$

where $\Delta\tilde{t}$ is a *pseudo time step*. Since $\mathbf{u} - \text{nojac}(\mathbf{u})$ is always zero, this term does not affect the final solution. It does, however, affect the discrete equation system and effectively transforms a nonlinear iteration into a step of size $\Delta\tilde{t}$ of a time-dependent solver.

Pseudo time stepping is not active per default. The pseudo time step $\Delta\tilde{t}$ can be chosen individually for each element based on the local CFL number:

$$\Delta\tilde{t} = \text{CFL}_{\text{loc}} \frac{h}{|\mathbf{u}|}$$

where h is the mesh cell size. A small CFL number means a small time step. It is practical to start with a small CFL number and gradually increase it as the solution approaches steady state.

If the automatic expression for CFL_{loc} is set to the built-in variable `CFLCMP`, then the automatic setting suggests a PID regulator for the pseudo time step in the default solver. The PID regulator starts with a small CFL number and increases CFL_{loc} as the solution comes closer to convergence.

The default manual expression is

$$\begin{aligned} & 1.3^{\min(\text{niterCMP}, 9)} + \\ & \text{if}(\text{niterCMP} > 20, 9 \cdot 1.3^{\min(\text{niterCMP} - 20, 9)}, 0) + \\ & \text{if}(\text{niterCMP} > 40, 90 \cdot 1.3^{\min(\text{niterCMP} - 40, 9)}, 0) \end{aligned} \quad (7-49)$$

The variable `niterCMP` is the nonlinear iteration number. It is equal to one for the first nonlinear iteration. CFL_{loc} starts at 1.3 and increases by 30% each iteration until it

reaches $1.3^9 \approx 10.6$. It remains there until iteration number 20 at which it starts to increase until it reaches approximately 106. A final increase after iteration number 40 then takes it to 1060. [Equation 7-49](#) can, for some advanced flows, increase CFL_{loc} too slowly or too quickly. CFL_{loc} can then be tuned for the specific application.



For details about the CFL regulator, see [Pseudo Time Stepping](#).

Nitsche Constraints

Some boundary conditions are implemented using Nitsche constraints. These boundary conditions include

- [Wall](#) — Slip, sliding walls, and moving walls (that is, walls with nonzero translational velocity).
- [Periodic Flow Condition](#)
- [Flow Continuity](#)

The formulation used in the Fluid Flow interfaces in single-phase flow interfaces corresponds to the Symmetric Interior Penalty Galerkin method (SIPG). The SIPG method can be regarded to satisfy the boundary conditions in an integral sense rather than pointwise. More information on SIPG can be found in [Ref. 15](#).

In particular, the SIPG formulation includes a penalty parameter that must be large enough for the formulation to be coercive. The higher the value, the better the boundary condition is fulfilled, but a too high value results in an ill-conditioned equation system. The penalty parameter is implemented according to [Ref. 16](#).

Particle Tracing in Fluid Flow

The Particle Tracing Module is available to assist with these types of modeling problems.

It is possible to model particle tracing with COMSOL Multiphysics provided that the impact of the particles on the flow field is negligible. First compute the flow field, and then, as an analysis step, calculate the motion of the particles. The motion of a particle is defined by Newton's second law

$$m \frac{d^2 \mathbf{x}}{dt^2} = \mathbf{F} \left(t, \mathbf{x}, \frac{d\mathbf{x}}{dt} \right)$$

where \mathbf{x} is the position of the particle, m the particle mass, and \mathbf{F} is the sum of all forces acting on the particle. Examples of forces acting on a particle in a fluid are the drag force, the buoyancy force, and the gravity force. The drag force represents the force that a fluid exerts on a particle due to a difference in velocity between the fluid and the particle. It includes the viscous drag, the added mass, and the Basset history term. Several empirical expressions have been suggested for the drag force. One of those is the one proposed by Khan and Richardson (Ref. 13). That expression is valid for spherical particles for a wide range of particle Reynolds numbers. The particle Reynolds number is defined as

$$\text{Re}_p = \frac{|\mathbf{u} - \mathbf{u}_p| 2r \rho}{\mu}$$

where \mathbf{u} is the velocity of the fluid, \mathbf{u}_p the particle velocity, r the particle radius, ρ the fluid density, and μ the dynamic viscosity of the fluid. The empirical expression for the drag force according to Khan and Richardson is

$$\mathbf{F} = \pi r^2 \rho |\mathbf{u} - \mathbf{u}_p| (\mathbf{u} - \mathbf{u}_p) [1.84 \text{Re}_p^{-0.31} + 0.293 \text{Re}_p^{0.06}]^{3.45}$$



The model *Flow Past a Cylinder* (Application Library path **COMSOL_Multiphysics/Fluid_Dynamics/cylinder_flow**) demonstrates how to add and set up particle tracing in a plot group using the **Particle Tracing with Mass** node. It uses the predefined Khan–Richardson model for the drag force and neglects gravity and buoyancy forces.

References for the Single-Phase Flow, Laminar Flow Interfaces

1. G.G. Stokes, *Trans. Camb. Phil. Soc.*, vol. 8, pp. 287–305, 1845.
2. P.M. Gresho and R.L. Sani, *Incompressible Flow and the Finite Element Method, Volume 2: Isothermal Laminar Flow*, John Wiley & Sons, 2000.
3. G.K. Batchelor, *An Introduction To Fluid Dynamics*, Cambridge University Press, 1967.
4. R.L. Panton, *Incompressible Flow*, 2nd ed., John Wiley & Sons, 1996.

5. I. Harari and T.J.R. Hughes, “What are C and h ? Inequalities for the Analysis and Design of Finite Element Methods,” *Comput. Methods Appl. Mech. Eng.*, vol. 97, pp. 157–192, 1992.
6. Y. Bazilevs, V.M. Calo, T.E. Tezduyar, and T.J.R. Hughes, “ γ -Discontinuity Capturing for Advection-dominated Processes with Application to Arterial Drug Delivery,” *Int. J. Num. Meth. Fluids*, vol. 54, pp. 593–608, 2007.
7. R.B. Bird, W.E. Stewart, and E.N. Lightfoot, *Transport Phenomena*, 2nd ed., John Wiley & Sons, 2007.
8. T.J.R. Hughes and M. Mallet, “A New Finite Element Formulation for Computational Fluid Dynamics: III. The Generalized Streamline Operator for Multidimensional Advective-Diffusive System,” *Comput. Methods Appl. Mech. Eng.*, vol. 58, pp. 305–328, 1986.
9. G. Hauke and T.J.R. Hughes, “A Unified Approach to Compressible and Incompressible Flows,” *Comput. Methods Appl. Mech. Eng.*, vol. 113, pp. 389–395, 1994.
10. G. Hauke, “Simple Stabilizing Matrices for the Computation of Compressible Flows in Primitive Variables”, *Comput. Methods Appl. Mech. Eng.*, vol. 190, pp. 6881–6893, 2001.
11. M.-C. Hsu, Y. Bazilevs, V.M. Cali, T.E. Tezduyar, and T.J.R. Hughes, “Improving stability of stabilized and multiscale formulations in flow simulations at small time steps,” *Comput. Methods Appl. Mech. Eng.*, vol. 199, pp. 828–840, 2010.
12. D.J. Tritton, *Physical Fluid Dynamics*, 2nd ed., Oxford University Press, 1988.
13. J.M. Coulson and J.F. Richardson, “Particle Technology and Separation Processes,” *Chemical Engineering, Volume 2*, Butterworth-Heinemann, 2002.
14. J.L. Guermond, P. Mineev, and J. Shen, “An overview of projection methods for incompressible flows,” *Comput. Methods Appl. Mech. Eng.*, vol. 195, pp. 6011–6045, 2006.
15. B. Rivière, *Discontinuous Galerkin Methods for Solving Elliptic and Parabolic Equations*, SIAM, 2008.
16. Y. Epshteyn and B. Rivière, “Estimation of penalty parameters for symmetric interior penalty Galerkin methods,” *J. Comput. Appl. Math.*, vol. 206, pp. 843–872, 2007.

17. R.P. Chhabra and J.F. Richardson, *Non-Newtonian Flow and Applied Rheology*, 2nd ed., Elsevier, 2008.

18. Y. Bazilevs and T.J.R. Hughes, “Weak imposition of Dirichlet boundary conditions in fluid mechanics,” *Comput. Fluids*, vol. 36, pp. 12–26, 2007.

Theory for the Darcy's Law Interface

The [Darcy's Law Interface](#) theory is described in this section:

- [About Darcy's Law](#)
- [Darcy's Law — Equation Formulation](#)
- [Storage Models](#)
- [Average Linear Velocity](#)
- [Dual Porosity and Dual Permeability Theory](#)
- [References for the Darcy's Law Interface](#)

About Darcy's Law

In a porous medium, the global transport of momentum by shear stresses in the fluid is often negligible, because the pore walls impede momentum transport to the fluid outside the individual pores. A detailed description, down to the resolution of every pore, is not practical in most applications. A homogenization of the porous and fluid media into a single medium is a common alternative approach. Darcy's law together with the continuity equation and equation of state for the pore fluid (or gas) provide a complete mathematical model suitable for a wide variety of applications involving porous media flows, for which the pressure gradient is the major driving force.

Darcy's law describes fluid movement through interstices in a porous medium. Because the fluid loses considerable energy to frictional resistance within pores, flow velocities in porous media are very low. The Darcy's Law interface can be applied to small-scale tasks in chemical engineering as well as to large-scale geophysical or hydrological tasks such as water moving in an aquifer or stream bank, oil migrating to a well, and even magma rising through the earth to a chamber in a volcano (see [Ref. 1](#), [Ref. 2](#), [Ref. 3](#), and [Ref. 4](#)). Also set up multiple Darcy's Law interfaces to model multiphase flows involving more than one mobile phase.

Darcy's law describes flow in porous media driven by gradients in the hydraulic potential field, which has units of pressure. For many applications it is convenient to represent the total hydraulic potential or the pressure and the gravitational components with equivalent heights of fluid or head. Division of potential by the fluid weight can simplify modeling because units of length make it straightforward to compare to many physical data. Consider, for example, fluid levels in wells, stream heights, topography, and velocities. The physics interface also supports specifying

boundary conditions and result evaluation using hydraulic head and pressure head. In the physics interface, pressure is always the dependent variable.

Darcy's Law — Equation Formulation

Darcy's law states that the velocity field is determined by the pressure gradient, the fluid viscosity, and the structure of the porous medium:

$$\mathbf{u} = -\frac{\kappa}{\mu} \nabla p \quad (7-50)$$

In this equation, \mathbf{u} is the Darcy's velocity or specific discharge vector (SI unit: m/s); κ is the permeability of the porous medium (SI unit: m²); μ is the fluid's dynamic viscosity (SI unit: Pa·s); p is the pore pressure (SI unit: Pa) and ρ is the density of the fluid (SI unit: kg/m³).



- The above equation formulation is called linear Darcy's law. The applicability of this formulation is discussed in the chapter [About Darcian and Non-Darcian Flow](#) in the *Porous Media Flow Module User's Guide*.
- Permeability can be defined in different ways, either directly or based on predefined permeability models. These are described in detail in the chapter [Permeability Models](#).
- For a detailed overview of the permeability models available in each product visit <https://www.comsol.com/products/specifications/>.

The Darcy's Law interface combines Darcy's law with the continuity equation

$$\frac{\partial}{\partial t}(\rho \varepsilon_p) + \nabla \cdot (\rho \mathbf{u}) = Q_m \quad (7-51)$$

In the above equation, ρ is the fluid density (SI unit: kg/m³), ε_p is the porosity, and Q_m is a mass source term (SI unit: kg/(m³·s)). Porosity is defined as the fraction of the control volume that is occupied by pores. Thus, the porosity can vary from zero for pure solid regions to unity for domains of free flow.

For large-scale applications it might be necessary to take gravity effects into account. Darcy's law then applies when the gradient in hydraulic potential drives fluid movement in the porous medium. Darcy's law then has the form:

$$\mathbf{u} = -\frac{\kappa}{\mu}(\nabla p - \rho \mathbf{g}) \quad (7-52)$$



- See the section [Gravity Effects](#) in the *Subsurface Flow Module User's Guide*.
- Note that gravity effects are only included in some modules. For a detailed overview of the functionality available in each product visit <https://www.comsol.com/products/specifications/>.
- Gravity effects are not active by default. Select the check box **Include gravity** to activate the acceleration of gravity. Setting the elevation D to zero also turns off gravity effects.

Storage Models

The continuity equation (Equation 7-51) allows flexible specification of relationships between parameters like density or permeability with respect to variables such as pressure, temperature, concentration, and more.

Expanding the time-derivative term and defining the porosity and density as functions of the pressure and using the chain rule results in

$$\frac{\partial}{\partial t}(\rho \varepsilon_p) = \varepsilon_p \frac{\partial \rho}{\partial t} + \rho \frac{\partial \varepsilon_p}{\partial t} = \varepsilon_p \frac{\partial \rho}{\partial p} \frac{\partial p}{\partial t} + \rho \frac{\partial \varepsilon_p}{\partial p} \frac{\partial p}{\partial t}$$

By inserting the definition of fluid compressibility $\chi_f = (1/\rho)(\partial \rho / \partial p)$ to the right-hand side and rearrange the following expression is obtained

$$\frac{\partial(\rho \varepsilon_p)}{\partial t} = \rho \left(\varepsilon_p \chi_f + \frac{\partial \varepsilon_p}{\partial p} \right) \frac{\partial p}{\partial t} = \rho S_p \frac{\partial p}{\partial t}$$

Using this relation, the generalized governing equation (Equation 7-51) takes the following form:

$$\rho S_p \frac{\partial p}{\partial t} + \nabla \cdot (\rho \mathbf{u}) = Q_m \quad (7-53)$$

In this equation, S_p is the storage coefficient (SI unit: 1/Pa), which can be interpreted as the weighted compressibility of the porous material and the fluid. The storage can be an expression involving results from a solid-deformation equation or an expression involving temperatures and concentrations from other analyses. The Darcy's Law

interface implements Equation 7-53 in the **Porous Medium** node, which explicitly includes different storage models to choose from:

- **From density and porosity**, where the storage directly depends on changes in porosity or fluid density
- **Linearized storage**, which defines S_p using the compressibility of the fluid χ_f and of the porous matrix χ_p according to

$$S_p = \varepsilon_p \chi_f + (1 - \varepsilon_p) \chi_p$$

- **Poroelastic storage** where

$$S_p = \varepsilon_p \chi_f.$$



Storage models are only available for the Subsurface Flow Module and the Porous Media Flow Module. For a detailed overview of the functionality available in each product visit <https://www.comsol.com/products/specifications/>.

Average Linear Velocity

Because fluids typically occupy only 10% to 50% of a porous medium, it follows that velocities within the pore channels exceed the Darcy velocity, \mathbf{u} , on the order of two to ten times. For clarity, the physics interface includes the average linear velocity within the pores, \mathbf{u}_α , (also termed the seepage velocity) defined as $\mathbf{u}_\alpha = \mathbf{u}/\varepsilon_p$, where ε_p is the porosity.

Dual Porosity and Dual Permeability Theory

The first well known publication on this topic is “The Behavior of Naturally Fractured Reservoirs” by J.E. Warren and P.J. Root from 1963. Since then the researchers further developed the idea of a dual porosity/permeability type of a porous medium. One of the well established models is based on the findings of H. Gerke and M. van Genuchten (Ref. 9). Basically the idea behind is to solve for each part of the porous medium (macro- and micropores) the relevant equations and connect them via an exchange term.

DUAL POROSITY MEDIUM

Darcy's Law is solved for the macropores and taking into account their volume fraction θ_M the equation reads:

$$\theta_M \left(\rho S_{p,M} \frac{\partial p_M}{\partial t} + \nabla \cdot (\rho \mathbf{u}_M) \right) = \theta_M Q_M - Q_{ip} \quad (7-54)$$

The term Q_{ip} describes the mass source from the [Interporosity Flow](#) which is the mass transfer from the macropores to the micropores system. An additional ODE for the (passive) micropores is solved which only act as additional storage volume:

$$(1 - \theta_M) \left(\rho S_{p,m} \frac{\partial p_m}{\partial t} \right) = (1 - \theta_M) Q_M + Q_{ip}.$$

The indices M and m stand for macropores and micropores, respectively.

DUAL PERMEABILITY MEDIUM

Darcy's law has to be solved for both the macroscale system and the microscale system:

$$\begin{aligned} \theta_M \left(\frac{\partial}{\partial t} (\varepsilon_{p,M} \rho) + \nabla \cdot (\rho \mathbf{u}_M) \right) &= -Q_{ip} + \theta_M Q_m \\ (1 - \theta_M) \left(\frac{\partial}{\partial t} (\varepsilon_{p,m} \rho) + \nabla \cdot (\rho \mathbf{u}_m) \right) &= Q_{ip} + (1 - \theta_M) Q_m \\ p &= \theta_M p_M + (1 - \theta_M) p_m \end{aligned} \quad (7-55)$$

θ_M is the volume fraction of the macropores, Q_{ip} denotes the interporosity flow, signifying the mass transfer from the macropores (identified by index M) to the micropores (identified by index m).

Solving Darcy's law for both systems entails solving two equations, each associated with dependent pressure variables p_m and p_M . These equations are coupled via Q_{ip} . From this, average quantities for the dual permeability medium as a whole are computed. The average pressure of the dual permeability medium is defined as:

$$p = \theta_M p_M + (1 - \theta_M) p_m$$

Likewise, average values for permeability, storage, velocity and other relevant parameters are computed.

UNSATURATED DUAL PERMEABILITY MEDIUM

Use the **Unsatrated Dual Permeability Medium** feature to model the transport in an unsaturated dual permeability medium where the Richards' Equation ([Equation 4-26](#)) describes the transport in each system.

$$\begin{aligned}
\theta_M \left(\rho \left(S_{c,M} S_{p,M} + \frac{C_{m,M}}{\rho g} \right) \frac{\partial p_M}{\partial t} + \nabla(\rho \mathbf{u}_M) \right) &= -\mathbf{Q}_{ip} + \theta_M \mathbf{Q}_m \\
(1 - \theta_M) \left(\rho \left(S_{c,m} S_{p,m} + \frac{C_{m,m}}{\rho g} \right) \frac{\partial p_m}{\partial t} + \nabla(\rho \mathbf{u}_m) \right) &= \mathbf{Q}_{ip} + (1 - \theta_M) \mathbf{Q}_m \\
p &= \theta_M p_M + (1 - \theta_M) p_m
\end{aligned} \tag{7-56}$$

θ_M is the volume fraction of the macropores, \mathbf{Q}_{ip} is the interporosity flow which is the mass transfer from the macroscale to the microscale system. The indices **M** and **m** stand for macropores and micropores, respectively.

INTERPOROSITY FLOW

Specify the **Fluid Transfer Function** α_w which is used to calculate the interporosity flow, which is the mass exchange between macro- and microscale system:

$$\mathbf{Q}_{ip} = \alpha_w (p_M - p_m) \tag{7-57}$$

with p_M being the pressure within the macroscale system and p_m the pressure within the microscale system

References for the Darcy's Law Interface

-
1. J. Bear, *Hydraulics of Groundwater*, McGraw Hill, 1979.
 2. S.E. Ingebritsen and W.E. Sanford, *Groundwater in Geologic Processes*, Cambridge University Press, 1998.
 3. N.H. Sleep and K. Fujita, *Principles of Geophysics*, Blackwell Science, 1997.
 4. D.L. Turcotte and G. Schubert, *Geodynamics*, Cambridge University Press, 2002.
 5. J. Bear, *Dynamics of Fluids in Porous Media*, Elsevier Scientific Publishing, 1972.
 6. Ö. Akgiray and A.M. Saatç?, "A New Look at Filter Backwash Hydraulics," *Water Science and Technology: Water Supply*, vol. 1, no. 2, pp. 65–72, 2001.
 7. L. Klinkenberg, "The permeability of porous media to liquids and gases," *Drilling and Production Practice*, Am. Petroleum Inst., pp. 200–213, 1941.
 8. Yu-Shu Wu and others, "Gas Flow in Porous Media with Klinkenberg Effects," *Transport in Porous Media*, vol. 32, pp. 117–137, 1998.

9. H. Gerke and M. van Genuchten, "A dual-porosity model for simulating the preferential movement of water and solutes in structured porous media." *Water Resources Research*. 29. pp. 305-319. 1993.

Theory for the Free and Porous Media Flow, Brinkman Interface

The [Free and Porous Media Flow, Brinkman Interface](#) uses the Navier–Stokes equations to describe the flow in open regions, and the Brinkman equations to describe the flow in porous regions.

The same fields, \mathbf{u} and p , are solved for in both the free flow domains and in the porous domains. This means that the pressure in the free fluid and the pressure in the pores is continuous over the interface between a free flow domain and a porous domain. It also means that continuity is enforced between the fluid velocity in the free flow and the Darcy velocity in the porous domain. This treatment is one of several possible models for the physics at the interface. Examples of other models can be found in [Ref. 1](#).

The continuity in \mathbf{u} and p implies a stress discontinuity at the interface between a free-flow domain and a porous domain. The difference corresponds to the stress absorbed by the rigid porous matrix, which is a consequence implicit in the formulations of the Navier–Stokes and Brinkman equations.

Reference for the Free and Porous Media Flow, Brinkman Interface

1. M.L. Bars and M.G. Worster, “Interfacial Conditions Between a Pure Fluid and a Porous Medium: Implications for Binary Alloy Solidification,” *J. Fluid Mech.*, vol. 550, pp. 149–173, 2006.

Theory for the Free and Porous Media Flow, Darcy Interface

The **Free and Porous Media Flow, Darcy** interface uses the Navier–Stokes equations to describe the flow in the free-flow region, implemented by the coupled Laminar Flow interface, and Darcy’s law, implemented by the coupled Darcy’s Law interface, to describe the flow in the porous region.

In the free-flow region, the velocity \mathbf{u} and pressure p are solved for, whereas in the porous region only the pressure p is solved for, and the velocity is calculated from the pressure by Darcy’s law.

The coupling between the free and porous medium flow, implemented by the Free and Porous Media Flow Coupling, ensures conservation of mass across the free-porous interface, which is enforced by the condition

$$\mathbf{n} \cdot (\rho_{\text{ns}} \mathbf{u}_{\text{ns}}) = \mathbf{n} \cdot (\rho_{\text{d}} \mathbf{u}_{\text{d}}) \quad (7-58)$$

Here ρ_{ns} and \mathbf{u}_{ns} are the density and velocity on the free-flow side of the interface, ρ_{d} and \mathbf{u}_{d} the density and velocity on the porous side, and \mathbf{n} is a vector normal to the interface. In addition the coupling enforces the balance of the normal forces by:

$$p_{\text{ns}} - \mathbf{n} \cdot \mathbf{K} \mathbf{n} = p_{\text{d}} \quad (7-59)$$

where p_{ns} and p_{d} are the pressure on the free-flow side and porous side of the interface, respectively, and \mathbf{K} is the viscous stress tensor (defined only on the free-flow side).

For the coupling condition for the tangential velocity component, there are several options. One of the most widely used conditions is the **Beavers-Joseph** interface condition (Ref. 1):

$$(\mathbf{I} - \mathbf{n} \otimes \mathbf{n})(\mathbf{u}_{\text{ns}} - \mathbf{u}_{\text{d}}) = \frac{\sqrt{\text{tr}(\kappa)/n}}{\mu_{\text{ns}} a_{BJ}} (\mathbf{I} - \mathbf{n} \otimes \mathbf{n}) \mathbf{K} \mathbf{n} \quad (7-60)$$

where a_{BJ} is the Beavers and Joseph parameter, κ is the permeability tensor of the porous medium (defined on the porous side of the interface), μ_{ns} is the fluid’s dynamic viscosity on the free-flow side of the interface, and n is the number of space dimensions.

When the velocity in the porous domain is much smaller than the velocity in the free flow, one can use a modification of the Beavers–Joseph condition which is given by the **Beavers–Joseph–Saffman** interface condition (Ref. 2):

$$(\mathbf{I} - \mathbf{n} \otimes \mathbf{n})\mathbf{u}_{\text{ns}} = \frac{\sqrt{\text{tr}(\boldsymbol{\kappa})/n}}{\mu_{\text{ns}}\alpha_{BJ}}(\mathbf{I} - \mathbf{n} \otimes \mathbf{n})\mathbf{K}\mathbf{n} \quad (7-61)$$

For cases when the permeability tensor is not isotropic, the **Use projected permeability** option allows to take into account only the permeability in the direction of the tangential velocity component. This is accomplished by replacing the $\sqrt{\text{tr}(\boldsymbol{\kappa})/n}$ term on the right hand side of Equation 7-60 and Equation 7-61 by:

$$\sqrt{\mathbf{t} \cdot \boldsymbol{\kappa} \mathbf{t}} \quad (7-62)$$

with \mathbf{t} a unit vector tangent to the interface for 2D and 2D-axisymmetric cases, and for 3D cases by:

$$\sqrt{\mathbf{v} \cdot \boldsymbol{\kappa} \mathbf{v}} \quad (7-63)$$

with \mathbf{v} given by:

$$\mathbf{v} = \frac{(\mathbf{I} - \mathbf{n} \otimes \mathbf{n})\mathbf{K}\mathbf{n}}{\|(\mathbf{I} - \mathbf{n} \otimes \mathbf{n})\mathbf{K}\mathbf{n}\|} \quad (7-64)$$

If one considers the limit of the Beavers–Joseph condition for large values of the Beavers and Joseph parameter α_{BJ} , one obtains the **Continuous tangential velocity** condition:

$$(\mathbf{I} - \mathbf{n} \otimes \mathbf{n})(\mathbf{u}_{\text{ns}} - \mathbf{u}_{\text{d}}) = 0 \quad (7-65)$$

The same limit for the Beavers–Joseph–Saffman condition results in the **No slip** condition:

$$(\mathbf{I} - \mathbf{n} \otimes \mathbf{n})\mathbf{u}_{\text{ns}} = 0 \quad (7-66)$$

The **Viscous slip** condition allows for a more general coupling condition. This interface condition is given by:

$$(\mathbf{I} - \mathbf{n} \otimes \mathbf{n})(\mathbf{u}_{\text{ns}} - \mathbf{u}_{\text{b}}) = \frac{L_s}{\mu_{\text{ns}}}(\mathbf{I} - \mathbf{n} \otimes \mathbf{n})\mathbf{K}\mathbf{n} \quad (7-67)$$

Here L_s is a slip length, and \mathbf{u}_b a user-defined interfacial velocity.



Please find related information in the *CFD Module User's Guide*:

- [The Darcy's Law Interface](#)
 - [The Thin-Film and Porous Media Flow Interface](#)
 - [The Laminar Flow Interface](#)
 - [Theory for the Single-Phase Flow Interfaces](#)
-

References

1. G.S. Beavers and D.D. Joseph, "Boundary Conditions at a Naturally Permeable Wall," *J. Fluid Mech.*, vol. 30, 1967.
2. P.G. Saffman, "On the Boundary Condition at the Surface of a Porous Medium," *Stud. Appl. Maths*, vol. 50, 1971.

Theory for the Brinkman Equations Interface

The [Brinkman Equations Interface](#) theory is described in this section:

- [About the Brinkman Equations](#)
- [Brinkman Equations Theory](#)
- [References for the Brinkman Equations Interface](#)

About the Brinkman Equations

In porous domains, the flow variables and fluid properties are defined at any point inside the medium by means of averaging of the actual variables and properties over a certain volume surrounding the point. This control volume must be small compared to the typical macroscopic dimensions of the problem, but it must be large enough to contain many pores and solid matrix elements.

Porosity is defined as the fraction of the control volume that is occupied by pores. Thus, the porosity can vary from zero for pure solid regions to unity for domains of free flow.

The physical properties of the fluid, such as density and viscosity, are defined as *intrinsic volume averages* that correspond to a unit volume of the pores. Defined this way, they present the relevant physical parameters that can be measured experimentally, and they are assumed to be continuous with the corresponding parameters in the adjacent free flow.

The flow velocity is defined as a *superficial volume average*, and it corresponds to a unit volume of the medium including both the pores and the matrix. It is sometimes called the Darcy velocity, defined as the volume flow rate per unit cross section of the medium. Such a definition makes the velocity field continuous across the boundaries between porous regions and regions of free flow.

Brinkman Equations Theory

The dependent variables in the Brinkman equations are the Darcy velocity and the pressure. The flow in porous media is governed by a combination of the continuity equation and the momentum equation, which together form the Brinkman equations:

$$\frac{\partial}{\partial t}(\varepsilon_p \rho) + \nabla \cdot (\rho \mathbf{u}) = Q_m \quad (7-68)$$

$$\frac{\rho}{\varepsilon_p} \left(\frac{\partial \mathbf{u}}{\partial t} + (\mathbf{u} \cdot \nabla) \frac{\mathbf{u}}{\varepsilon_p} \right) = -\nabla p + \nabla \cdot \left[\frac{1}{\varepsilon_p} \left\{ \mu (\nabla \mathbf{u} + (\nabla \mathbf{u})^T) - \frac{2}{3} \mu (\nabla \cdot \mathbf{u}) \mathbf{I} \right\} \right] - \left(\kappa^{-1} \mu + \frac{Q_m}{\varepsilon_p^2} \right) \mathbf{u} + \mathbf{F} \quad (7-69)$$

In these equations:

- μ (SI unit: kg/(m·s)) is the dynamic viscosity of the fluid
- \mathbf{u} (SI unit: m/s) is the velocity vector
- ρ (SI unit: kg/m³) is the density of the fluid
- p (SI unit: Pa) is the pressure
- ε_p is the porosity
- κ (SI unit: m²) is the permeability of the porous medium, and
- Q_m (SI unit: kg/(m³·s)) is a mass source or sink

Influence of gravity and other volume forces can be accounted for via the force term \mathbf{F} (SI unit: kg/(m²·s²)).

When the **Neglect inertial term (Stokes flow)** check box is selected, the term $(\mathbf{u} \cdot \nabla)(\mathbf{u}/\varepsilon_p)$ on the left-hand side of [Equation 7-69](#) is disabled.

The mass source, Q_m , accounts for mass deposit and mass creation within the domains. The mass exchange is assumed to occur at zero velocity.

The Forchheimer and Ergun drag options add a viscous force proportional to the square of the fluid velocity, $\mathbf{F} = -\rho\beta|\mathbf{u}|\mathbf{u}$, on the right-hand side of [Equation 7-69](#); see [References for the Darcy's Law Interface](#) for details.

In case of a flow with variable density, [Equation 7-68](#) and [Equation 7-69](#) must be solved together with the equation of state that relates the density to the temperature and pressure (for instance the ideal gas law).

For incompressible flow, the density stays constant in any fluid particle, which can be expressed as

$$\frac{\partial}{\partial t}(\varepsilon_p \rho) + \mathbf{u} \cdot \nabla \rho = 0$$

and the continuity equation (Equation 7-68) reduces to

$$\rho \nabla \cdot \mathbf{u} = Q_m$$

References for the Brinkman Equations Interface

1. D. Nield and A. Bejan, *Convection in Porous Media*, 3rd ed., Springer, 2006.
2. M. Le Bars and M.G. Worster, “Interfacial Conditions Between a Pure Fluid and a Porous Medium: Implications for Binary Alloy Solidification,” *J. Fluid Mech.*, vol. 550, pp. 149–173, 2006.

Theory for the Coupling of Fluid Flow to Electrochemical Reactions

Also see [Theory for the Coupling of Mass Transport to Electrochemical Reactions](#) for how to calculate molar and mass fluxes, sources, and sinks.

Momentum Sources and Sinks

The flow velocity, \mathbf{u} (SI unit: m/s), at a boundary is coupled to the total mass flux of the species at the electrode surface in the following way

$$\mathbf{u} \cdot \mathbf{n} = \frac{1}{\rho} \sum_i \mathbf{n}_i \cdot \mathbf{n} \quad (7-70)$$

where ρ (SI unit: kg/m³) is the density of the flowing media, \mathbf{n} the surface normal and \mathbf{n}_i is the mass flux of species i .

For flow interfaces solving for the velocity field, no-slip conditions are applied at the electrode surface, resulting in

$$\mathbf{u} = - \left(\frac{1}{\rho} \sum_i M_i N_i \right) \mathbf{n} \quad (7-71)$$

where M_i (SI unit: kg/mol) is the species mass and N_i (SI unit: mol/(m²·s)) the molar flux calculated by Faraday's law.

For a porous electrode the sum of all mass fluxes are added to the conservation equation according to:

$$\frac{\partial \rho}{\partial t} + \nabla \cdot (\rho \mathbf{u}) = \sum_i R_{i, \text{mass}} \quad (7-72)$$

Note that because the mass is usually not conserved within the species transporting phase (the right-hand side above being nonzero), the velocity field is not divergence free.

Heat Transfer

As with all other physical descriptions simulated by COMSOL Multiphysics, any description of heat transfer can be directly coupled to any other physical process. This is particularly relevant for systems based on chemical reactions and mass transfer along with fluid flow. These physics interfaces are found under the **Heat Transfer** branch ().

The basic functionality for simulating heat transfer in homogeneous media is described in [The Heat Transfer Interfaces](#) in the *COMSOL Multiphysics Reference Manual*. The Battery Design Module has extra functionality for simulating heat transfer in porous media. The documentation of [The Heat Transfer in Porous Media Interface](#) is found in the *Heat Transfer Module User's Guide*, which is supplied with the Battery Design Module irrespective of whether a separate Heat Transfer Module license is purchased.

Most electrochemistry interfaces automatically define heat source variables that may be coupled to the heat transfer interfaces either manually or by the use of a [Electrochemical Heating](#) multiphysics node. See the [Theory for Electrochemical Heat Sources](#) section in the [Electrochemistry Interfaces](#) chapter for more information on how these heat source variables are computed.

Solid Mechanics

The Battery Design Module extends in the [The Solid Mechanics Interface](#) with functionality for modeling strains occurring as a result of insertion of species (atoms) into electrodes.

See the [Intercalation Strain](#) node in the *COMSOL Multiphysics Reference Manual*.

Thermodynamics

This chapter describes how you can use the thermodynamics functionality to define thermo-physical and transport properties. The properties in turn can be used when simulating chemical reaction systems, or any type of transport model involving mass transfer, fluid flow, or heat transfer.

In this chapter:

- [Using Thermodynamic Properties](#)
- [Thermodynamic Models and Theory](#)

Using Thermodynamic Properties

In this section:

- [Workflow for Thermodynamics Property Calculations](#)
- [Thermodynamics](#)
- [Thermodynamic System](#)
- [External Thermodynamic Packages](#)
- [External Thermodynamic System](#)
- [Predefined System](#)
- [Exporting and Importing Thermodynamic Systems](#)
- [Species Property](#)
- [Mixture Property](#)
- [Equilibrium Calculation](#)
- [Generate Chemistry](#)
- [Generate Material](#)
- [Coupling with the Reaction Engineering and the Chemistry Interfaces](#)
- [Evaluating a Property Function in a Physics Interface](#)
- [User-Defined Species](#)
- [References](#)

Workflow for Thermodynamics Property Calculations

The thermodynamic properties database, together with the thermodynamic calculator, make it possible to evaluate physical properties of fluids such as heat capacity, thermal conductivity, density, and diffusivity, as well as equilibrium compositions of two phases at equilibrium. The properties can be calculated for pure fluids, mixtures, and for two-phase fluid systems consisting of pure species as well as mixtures.

Using the thermodynamics functionality involves the following main steps:

- 1 Add the **Thermodynamics** node and create a thermodynamic system to add properties for a selected set of chemical compounds, referred to as chemical species in this manual. A thermodynamic system can be created in the following ways:
 - A built-in **Thermodynamic System** uses the built-in, or user-defined, property database with native functionality for thermodynamic property calculations.
 - An **External Thermodynamic System** uses properties from an installed external package provider. For more information on how to enable the use of external packages see the [Installing External Thermodynamic Packages — An Example](#).
 - A **Predefined System** uses the built-in database with native functionality to set up one of the following common systems; Dry air, Moist air, or Water-steam.
- 2 Once a thermodynamic system is set up, it can be used to define a multitude of property functions. The [Generate Material](#) option provides a fast route to defining the material properties most commonly required for fluid flow, heat transfer and mass transfer modeling. By specifying the composition and phase of the mixture, a **Material** node can automatically be set up. The material node can include properties such as density, heat capacity, heat capacity ratio, thermal conductivity and viscosity.
- 3 Users of the Reaction Engineering, or Chemistry interface can couple chemical species in these interfaces with the chemical species in the thermodynamic system. When [Coupling with the Reaction Engineering and the Chemistry Interfaces](#) the required property parameters and functions are automatically added and visualized as nodes under the corresponding thermodynamic system node.
- 4 As an alternative to the functions automatically set up when using Generate Material or coupling to, for example, Chemistry, functions or constants can be set up manually for any thermodynamic system. This is accomplished using the thermodynamic features [Species Property](#), [Mixture Property](#) or [Equilibrium Calculation](#). You can, for example, create a **Species Property** function describing the density of a fluid, and use this function in a fluid-flow interface. With **Mixture Property** you can define mixture functions, that is, functions that depend on the composition of a mixture, describing for example density, enthalpy, or heat capacity.

The functionalities described in Step 2–4 generate functions and constants, defined by a thermodynamic system, that can be used in any physics interface in COMSOL Multiphysics. The functions are used to evaluate fluid properties that depend on variables such as temperature, pressure, and mixture composition. For more information, see [Evaluating a Property Function in a Physics Interface](#).

Thermodynamics

To access the functionality for thermodynamic calculations, right-click the **Global Definitions** node in the **Model Builder** tree and select **Thermodynamics** (). When the model includes a Component, **Thermodynamics** is also available in the **Physics** toolbar.

Using the Reaction Engineering or Chemistry interfaces, **Thermodynamics** is also available on the **Reaction Engineering** or **Chemistry** toolbar.

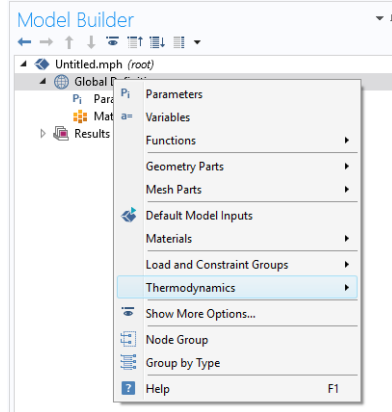

Figure 10-1: The *Thermodynamics* is always available under *Global Definitions*.

Thermodynamic properties given as parameters or functions are collected in a so called thermodynamic system. Each thermodynamic system includes a set of available species and phases, as well as different models used for the thermodynamic property calculations, for example an equation of state such as Peng–Robinson.

Select **Thermodynamic System** in the context menu to add a thermodynamic system that uses the built-in database included with COMSOL Multiphysics.

As an alternative, selecting **External Thermodynamic System** can make use of an installed thermodynamics software to make the corresponding calculations.

The option **Predefined System**, allows you to set up one of the following systems; Dry air, Moist air, or Water-steam.

It is also possible to import previously created and stored thermodynamic systems by selecting **Import Thermodynamic System** (see [Exporting and Importing Thermodynamic Systems](#)).

In addition to creating thermodynamic systems, you can also define **User-Defined Species** in Thermodynamics. Use **User-Defined Species** to add new species that are not available in the COMSOL database. You can also edit available species in the database.

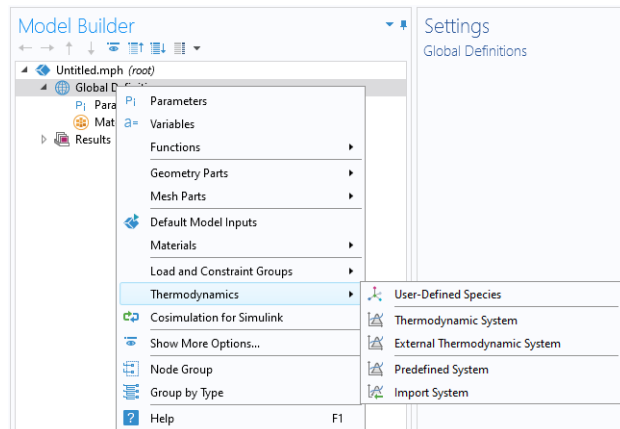

Figure 10-2: Adding Thermodynamic Systems to the Thermodynamics node. Note that external package providers have been installed.

When a thermodynamic system has been added, thermodynamic and transport properties are defined by functions. These can be used to describe properties for pure species, mixtures, and for gas-liquid (or liquid-liquid) systems at equilibrium.

Thermodynamic System

A thermodynamic system is used to describe properties of pure species and mixtures of chemical compounds for liquids, gases, liquid-vapor equilibria, and liquid-liquid equilibria. It specifies the available species and the phases (states of aggregation) that are present in the modeled system. It also defines and evaluates the functions for thermodynamic and transport properties of the chemical system, that is, the species and mixture properties for liquids, gases, and phase equilibria.

To create a **Thermodynamic System**, start the **Thermodynamic System Wizard** in one of the following ways:

- Right-click the **Global Definitions** node, select **Thermodynamics** and choose **Thermodynamic System**.
- Using the Reaction Engineering interface, choose **Thermodynamic System** from the **Thermodynamics** section of the **Reaction Engineering** toolbar.
- Correspondingly, using the Chemistry interface, choose **Thermodynamic System** from the **Thermodynamics** section of the **Chemistry** toolbar.

The **Thermodynamic System Wizard** contains the following steps:

- 1 [Select System](#)
- 2 [Select Species](#)
- 3 [Select Thermodynamic Model](#)

SELECT SYSTEM

Use the **Select System** step in the wizard to define the phases in the modeled system. You can select **Gas**, **Liquid**, **Vapor-liquid**, **Vapor-liquid-liquid**, or **Liquid-liquid**. The names of the phases in the Selected system table can be changed by editing the element in the Name column. Click the **Next** button (→) to proceed to the next step in the wizard.

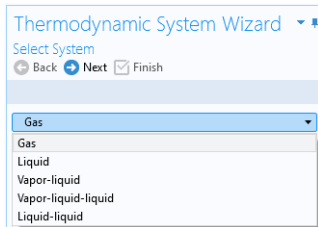





Figure 10-3: Thermodynamic System Wizard: Select System.

SELECT SPECIES

Use the **Species Type filter text** field to search among the available species in the **COMSOL** database or the **User-Defined Species**. Species can be searched for by typing the name, CAS number, or the chemical formula. Using a formula, all species whose chemical formula includes a combination of the given atoms are listed. For example, when searching for ammonia NH_3 or H_3N can be used.

Select one or more species in the list and click the **Add Selected** button (+) to add species to the **Selected species** table. You can also press the **Enter** key to add either the

first species in the list, or the species that have been selected. To remove species from the Selected species table, use either the Remove Selected button () or the Remove All button (), both located below the table. Click the **Next** button () to proceed to the next step in the wizard.

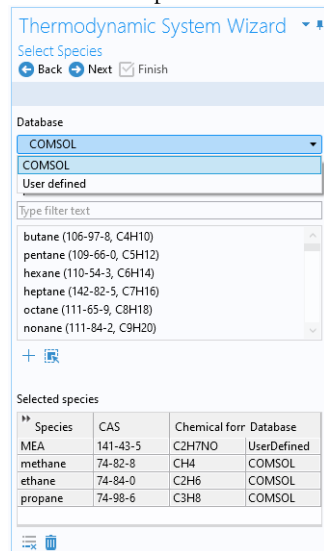

Figure 10-4: Thermodynamic System Wizard: Select Species.

SELECT THERMODYNAMIC MODEL

The Thermodynamic model controls the relations between the intensive thermodynamic properties of the system such as pressure, specific volume, and temperature. It also controls how extensive properties like enthalpy, entropy, or the heat capacity of the system are computed. Furthermore, the Thermodynamic model specifies the default models used to compute transport properties.

The following [Thermodynamic Models](#) are available for all phases:

- [Peng–Robinson](#)
- [Peng–Robinson \(Twu\)](#)
- [Soave–Redlich–Kwong](#)
- [Soave–Redlich–Kwong \(Graboski–Daubert\)](#)

For a system including only gas phase, or for liquid phase systems with thermodynamic models requiring an equation of state, the [Ideal Gas Law](#) is added to the available models in the **Gas phase model** list or **Equation of state** list.

When the system includes one or more liquid phases, the following additional models are also available (in the **Liquid phase model** list):

- [Chao–Seader \(Grayson–Streed\)](#)
- [Wilson](#)
- [NRTL](#)
- [UNIFAC VLE](#)
- [UNIQUAC](#)
- [Regular Solution](#)
- [Extended Regular Solution](#)
- [Ideal Solution](#)

These models correspond to activity models.

To calculate properties of water and steam, use the [Water \(IAPWS\)](#) model. This is available for systems that include a single water species.

For recommendations regarding the appropriate thermodynamic model, based on the available phases and the system pressure level, see the section [Selecting the Right Thermodynamic Model](#).

Select the **Advanced options** check box in order to manually control the models used for thermodynamic properties, transport properties, and surface tension. When this check box is selected, all available property models are shown in the property model table. The available property models are dependent on the phases available in the thermodynamic system.

When only a gas phase is present, models are available for the following properties:

- Gas diffusivity
- Gas thermal conductivity
- Gas viscosity

For a single-phase liquid, or for a two-phase liquid-liquid system, there are models for the following properties:

- Liquid diffusivity
- Liquid diffusivity at infinite dilution
- Liquid thermal conductivity

- Liquid viscosity
- Liquid volume

For systems with both vapor and liquid phases, all of the above properties are available, as well as Gas-liquid surface tension.

Property	Model
Gas diffusivity	Automatic
Gas-liquid surface tension	Ideal
Gas thermal conductivity	Kinetic theory
Gas viscosity	Brokaw
Liquid diffusivity	Wesselingh-Krishna
Liquid diffusivity at infinite dilution	Automatic
Liquid-liquid surface tension	None
Liquid thermal conductivity	Ideal
Liquid viscosity	Mass logarithmic mixing
Liquid volume	Soave-Redlich-Kwong

Figure 10-5: Thermodynamic System Wizard: Advanced thermodynamic model options available for a Vapor-liquid system.

Click the **Finish** button () to exit the **Thermodynamic System Wizard** and add the corresponding system under the **Thermodynamics** node. Note that the default node label reflects the available phase in the system. For example, when creating a vapor-liquid system, a node labeled **Vapor-Liquid System** is added. The name of the system can be changed using the Label text field in the Settings window for the system.

SETTINGS

Selecting a [Thermodynamic System](#) or [Predefined System](#) node shows its **Settings** window with a description of the package content and the available properties. Editing

the text in the Label text field changes the name of the system. Below follows a description of the thermodynamic system settings.

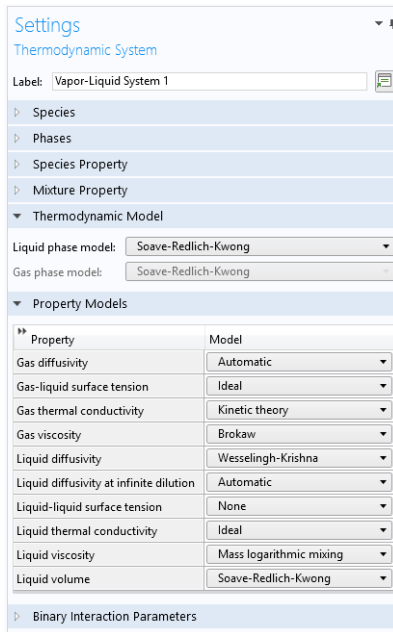

Figure 10-6: Thermodynamic System Settings.

Species:

Lists the species included in the thermodynamic system. You can change the list of species by right-clicking the **Thermodynamic System** node and selecting [Add or Remove Species](#).

Phases:

Lists the phases included in the thermodynamic system. You can add or remove phases, such as gas, liquid, or liquid-vapor, by right-clicking the **Thermodynamic System** node and selecting [Define System](#).

Species Property:

Lists the parameters and functions that describe thermodynamics and transport properties for pure species. Such functions may describe density, heat capacity, thermal conductivity, or other thermodynamic and transport properties. For more information, see [Species Property](#).

Mixture Property:

Lists the available mixture property functions. Note that you have to have a mixture model defined in order to use these functions. You can define a mixture property by right-clicking the **Thermodynamic System** node and selecting [Mixture Property](#).

Thermodynamic Model:

When a liquid is present, use the **Liquid phase model** list to select the thermodynamic model for this phase.

When a gas is present, use the **Gas phase model** list to select the thermodynamic model for this phase. If both gas and liquid phases are available, and the **Liquid phase model** is set to an equation of state, then the **Gas phase model** is set to the same model automatically.

Property Models:

Displays the settings for the available individual property models. The property models can be changed by selecting different values from the combo box in the Model column. For example, for **Gas thermal conductivity** you can select **Kinetic theory** or **Ideal** from the corresponding combo box. You can also select the property model in the last step of the thermodynamic system wizard by selecting the **Advanced option** check box, see [Select Thermodynamic Model](#).

Binary Interaction Parameters:

This section can be used to inspect and edit binary interaction parameters. Select a pair of species (first and second column, Species 1 and Species 2) as shown in [Figure 10-7](#) to edit the corresponding binary interaction parameter currently in use. In cases that the thermodynamic model has more than one type of binary interaction parameter, each type of the interaction parameter will be shown in a column in the table.

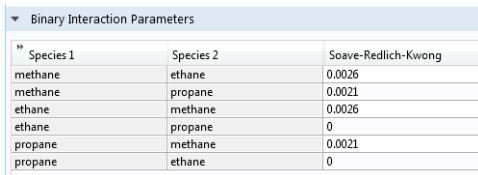

Binary Interaction Parameters		
Species 1	Species 2	Soave-Redlich-Kwong
methane	ethane	0.0026
methane	propane	0.0021
ethane	methane	0.0026
ethane	propane	0
propane	methane	0.0021
propane	ethane	0

Figure 10-7: Entering the Binary Interaction Parameters for the Soave–Redlich–Kwong model.

When a binary interaction parameter is not available in the database for a pair of species, the parameter value is set to zero (default value).

MODIFYING AN EXISTING SYSTEM

It is possible to modify an existing thermodynamic system, for example by changing the included species or phases. To do so, right-click the **Thermodynamic System** node and select [Add or Remove Species](#), or [Define System](#) from the context menu. Both of these options are available for systems created using Thermodynamic System. For a **Predefined System**, the option **Add or Remove Species** is available for Dry Air and Moist Air. For a Water-steam system, neither of the two options are available.

When the properties of a [User-Defined Species](#) have been changed, select [Update From Species](#) for the changes to take effect in the thermodynamic system.

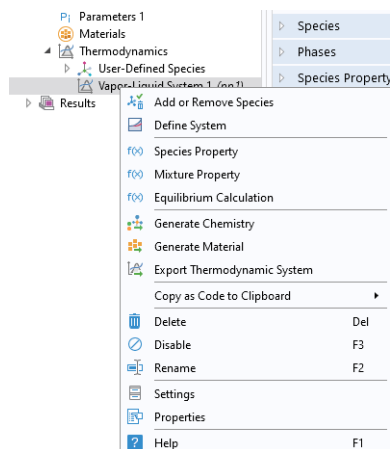

Figure 10-8: Modifying the species and phases of a thermodynamic system.

Add or Remove Species

Selecting **Add or Remove Species** takes you to the [Select Species](#) step in the **Thermodynamic System Wizard**. Use the **Add Species** button (**+**) to add a species to the **Selected Species** list. To remove a species, select it in the list and use the **Remove Species** button ().

Make sure to click the **Finish** button () in order for the changes to take effect.

Note that adding or removing species in a thermodynamic system that is currently coupled to a Reaction Engineering interface or a Chemistry interface breaks this coupling. See the [Coupling with the Reaction Engineering and the Chemistry Interfaces](#) for how to update this coupling.

Define System

Selecting **Define System** takes you to the [Select System](#) step in the **Thermodynamic System Wizard**. You can select the desired system from the list.

Make sure to click the **Finish** button () button in order for the changes to take effect.

Note that changing the phase(s) in a thermodynamic system that is currently coupled to a Reaction Engineering interface or a Chemistry interface breaks this coupling. See the [Coupling with the Reaction Engineering and the Chemistry Interfaces](#) section for how this coupling can be updated.

Update From Species

This option is available in a **Thermodynamic System** that includes a [User-Defined Species](#). Use it to update the system following a change in the species properties.

WARNING INFORMATION

A sanity check is always performed when a **Thermodynamic System** is created. If any problems are found, a Warning Information node listing the problems is added under the package. One example when this occurs is when a parameter required for the thermodynamic model, typically a binary interaction parameter, is not available in the database.

External Thermodynamic Packages

The thermodynamics functionality includes support for creating properties from external thermodynamic packages. In order to use external packages, the external software has to be CAPE-OPEN compliant. Thermodynamics in COMSOL Multiphysics supports the CAPE-OPEN Thermo 1.1 and the CAPE-OPEN Thermo 1.0 standards.

CAPE-OPEN is an open interface standard for chemical process simulation software ([Ref. 1](#)). This standard defines rules and interfaces that allows linking between compliant software. Some examples of CAPE-OPEN compliant software are:

- COCO/TEA (Free of charge package provider; see [Ref. 2](#)).
- Multiflash™ (KBC Advanced Technologies plc).
- VMGThermo™ (Virtual Materials Group, Inc.).
- Simulis® Thermodynamics (ProsSim SA).

- Aspen Properties, aspenONE[®] (Aspen Technology, Inc.).
- COMThermo[®] packages (comes with Aspen HYSYS[®]).

Accessing external thermodynamic systems allows species properties, mixture properties, as well as phases equilibrium calculations (gas-vapor, liquid-liquid) to be obtained from external software, such as the ones listed above.

INSTALLING EXTERNAL THERMODYNAMIC PACKAGES — AN EXAMPLE

TEA is a thermodynamics thermodynamic system that handles the physical and thermodynamic property calculations for the simulation environment COCO. The property data bank contains more than 190 commonly used chemicals, and the package exhibits more than 100 property calculation routines with their analytical or numerical derivatives. COCO is maintained by AmsterCHEM and is free to download from the Internet (Ref. 2).

To use the external physical and thermodynamic property calculations from COCO/TEA in COMSOL Multiphysics models, you need to go through the following steps:

- 1 Download and install COCO, which includes the TEA thermodynamic system manager. The software is available from www.cocosimulator.org/index_download.html.
- 2 Create and configure a thermodynamic system template that handles physical and thermodynamics calculations needed for your model. If you have already created a package template earlier, or if an adequate thermodynamic system already exists in the installation, this step is not needed.
- 3 Create an [External Thermodynamic System](#) node as detailed in the next section. The installed packages are available in the [Select Property Package](#) step of the Thermodynamic System Wizard.

External Thermodynamic System

The following assumes that you have installed external thermodynamic packages from a CAPE-OPEN compliant software in the manner outlined in [Installing External Thermodynamic Packages — An Example](#).

Locate the **Thermodynamics** node and right-click to add an **External Thermodynamic System** (Figure 10-2). Using a **Reaction Engineering** or **Chemistry** interface, you can also add an external package by choosing **External Thermodynamic System** from the **Thermodynamics** section of the **Reaction Engineering** or **Chemistry** toolbar.

SELECT PROPERTY PACKAGE

All installed packages, from providers such as COCO/TEA, Aspen Properties, and so on, are available in the **Thermodynamic System Wizard** (Figure 10-9). Select one of the packages and click the **Finish** button () in the upper right corner of the wizard in order to add the package as an **External Thermodynamic System** node under the **Thermodynamics** node.

When adding the package its default label reflects the included phases. For example, a node labeled **Vapor-Liquid System (External)** is created when adding an external package containing a vapor and a liquid phase. The name of the system can be changed using the Label text field in the Settings window for the system.

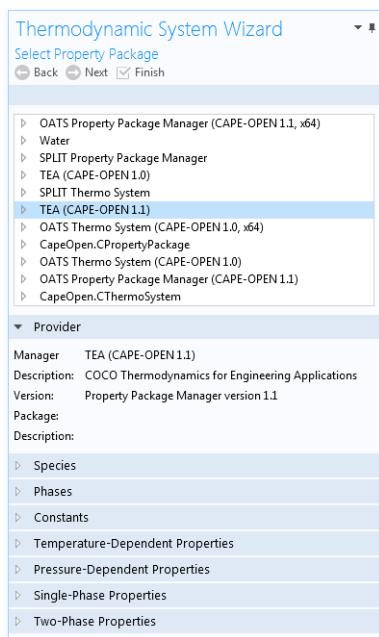

Figure 10-9: Available external thermodynamic systems. Use the Thermodynamic System Wizard to browse the contents of the installed external thermodynamic systems on your system. The example shows the packages shipped with the COCO provider.

SETTINGS

Selecting the **External Thermodynamic System** node shows the thermodynamic system settings with sections for available species, phases, species properties, and mixture properties. Editing the text in the Label text field changes the name of the system. Below follows a description of the thermodynamic system settings.

Provider

Contains information about the external thermodynamic system provider such as version, CAPE-OPEN compliance, and a short description of the external software that provides the thermodynamic system.

Species

Lists the species included in the selected thermodynamic system.

Phases

Lists the phases included in the selected thermodynamic system for example gas, liquid, gas-vapor, or liquid-liquid.

Species Properties

Lists the parameter values or the functions that describe species properties, for example molar mass, and properties available for pure compounds, such as density as a function of temperature.

Mixture Properties

Lists the available functions that describe mixture properties. One example is the density of a nonideal mixture as a function of composition.

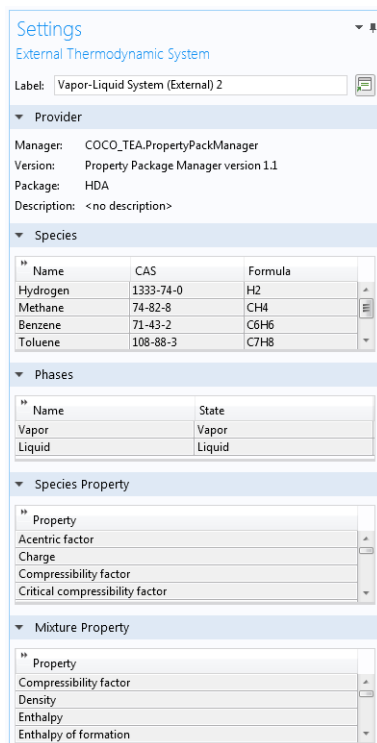

Figure 10-10: Settings window for an External Thermodynamic System.



The thermodynamic functionality supports package *persistence*. This means that an MPH-file for a model that uses a thermodynamic system stores that package definition in the file. You can use the mph-file to access a thermodynamic system defined in the corresponding model without having to store the thermodynamic system as a separate file.

Predefined System

A **Predefined System** uses the built-in database with native functionality to set up one of the following common systems; dry air, moist air, or water and steam.

To create a **Predefined System**, start the **Thermodynamic System Wizard** in one of the following ways:

- Right-click the **Global Definitions** node, select **Thermodynamics** and choose **Predefined System**.
- Using the Reaction Engineering interface, choose **Predefined System** from the **Thermodynamics** section of the **Reaction Engineering** toolbar.
- Correspondingly, using the Chemistry interface, choose **Predefined System** from the **Thermodynamics** section of the **Chemistry** toolbar.

The **Thermodynamic System Wizard** that opens is identical to the wizard used to create a **Thermodynamic System**, but with the important difference that all settings have been entered for the chosen predefined system. The wizard contains the following steps:

- 1 [Select System](#)
- 2 [Select Species](#)
- 3 [Select Thermodynamic Model](#)

SELECT SYSTEM

In the Select System window, choose one of the predefined systems in the list. Choose among **Dry air**, **Moist air**, and **Water-steam**. Click the Next button () to proceed to the next step in the wizard.

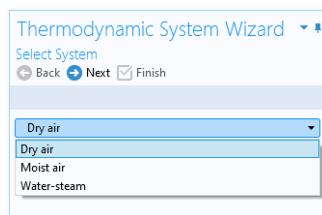

Figure 10-11: Thermodynamic System Wizard: Select Predefined System.

SELECT SPECIES

If Dry or Moist air was chosen in the Select System step, the **Selected species** table is populated with the species relevant for the chosen system. For Dry air the species are: nitrogen, oxygen, argon, carbon dioxide, neon, and helium. For Moist air the list also contains water. If instead Water-steam was chosen in the Select System step, the Next button in that step guides you directly to the Select Thermodynamic Model pane. No additions of species can be done in the wizard.

To add more species to the Dry air and Moist air systems, use the **Species Type filter text** field to search among the available species in the **COMSOL** database or the **User-Defined Species**. Species can be searched for by typing the name, CAS number, or the chemical formula. Select one or more species in the list and click the **Add Selected** button (**+**) to add species to the **Selected species** table. To remove species from the Selected species table, use either the Remove Selected button (**☒**) or the Remove All button (**☒**), both located below the table. Click the **Next** button (**➔**) to proceed to the next step in the wizard.

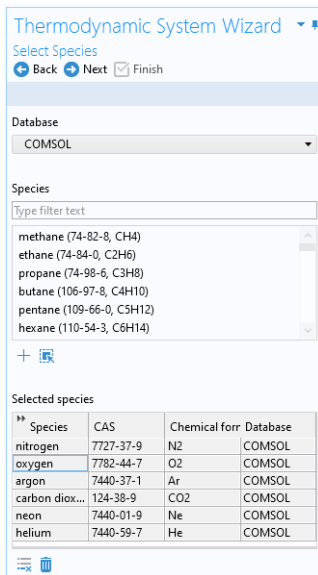

Figure 10-12: Thermodynamic System Wizard: Select Species.

SELECT THERMODYNAMIC MODEL

This last step of the Thermodynamic System Wizard allows you to choose what thermodynamic model to use. For the system Dry air and Moist air, the Ideal Gas law is chosen by default. For Water-steam, the model Water (IAPWS) is used. For more information about this step in the Thermodynamic System Wizard, see [Select Thermodynamic Model](#) for Thermodynamic System.

Click the **Finish** button () to exit the **Thermodynamic System Wizard** and add the corresponding **Predefined System** under the **Thermodynamics** node. Note that the default node label reflects the chosen predefined system.

SETTINGS

Selecting a **Predefined System** node shows its **Settings** window with a description of the package content and the available properties. For information about the content in the Settings window, see [Settings](#) for **Thermodynamic System** and **Predefined System**.

MODIFYING A PREDEFINED SYSTEM

Please see [Modifying an Existing System](#) for information about how to modify an existing thermodynamic system.

Exporting and Importing Thermodynamic Systems

EXPORT THERMODYNAMIC SYSTEM

Right-click the thermodynamic system node for the thermodynamic system that you want to export ([Figure 10-8](#)) and select **Export Thermodynamic System**. Use the **Select File** window to store the thermodynamic system.

Note that only the thermodynamic system definition is exported, for example the underlying species data (from the database), the included phases, and the applied thermodynamic models. Property values and functions created using the thermodynamic system are not stored.

IMPORT THERMODYNAMIC SYSTEM

Right-click the **Thermodynamics** node and select **Import Thermodynamic System** ([Figure 10-2](#)). Use the **Select File** window to navigate to a thermodynamic system file and click **Open**.

It is possible to manually modify the species properties, such as parameters and temperature-dependent functions, in the created Thermodynamic System by using **Export Thermodynamic System** and **Import Thermodynamic System**. In the saved xml file from **Export thermodynamic system**, there are all parameters and temperature-dependent properties for species, which are saved inside a `<Compound CompID=" name "></Compound>` block. For example, to edit the acentric factor of methane from 0.01141 to 0.2 perform the following steps

- Open the saved xml file for the thermodynamic system
- Find the compound methane which starts with the line:
`<Compound CompID="methane">`
- Find the line with the acentric factor and change it to
`<AcentricFactor >0.2</AcentricFactor>`.

To use the system with the updated species, right-click the Thermodynamics node and select Import System.

For temperature-dependent functions, for example for the (saturated) liquid density, the database input is of the form:

```
<Density>
  <Phase>Liquid</Phase>
  <Coefficients>Tlb;a0;a1;a2;a3;Tub</Coefficients>
  <Data>Tlb;f(Tlb);Tub;f(Tub)</Data>
<Comment></Comment>
</Density>
```

Here T_{lb} and T_{ub} defines the lower and upper bound for a temperature range, and a_1 to a_4 are the corresponding coefficients for a cubic polynomial as $f(T) = a_0 + a_1T + a_2T^2 + a_3T^3$ fitted for that range. Multiple sequential ranges can be added by appending temperature ranges and coefficient sets. The `<Data></Data>` block can be used to input data points directly.

The unit for temperature is K. The unit used for the temperature dependent properties (fitted polynomials functions) are defined in the table below:

TABLE 10-1: UNIT FOR TEMPERATURE-DEPENDENT PROPERTIES.

PROPERTY	UNIT
Liquid density	mol/m ³
Ideal heat capacity	J/mol/K
Ln vapor pressure	l
Heat of vaporization	J/mol
Vapor viscosity	Pa·s
Ln liquid viscosity	l
Vapor thermal conductivity	W/m/K
Liquid thermal conductivity	W/m/K
Surface tension	N/m

Species Property

A **Species Property** is used to define and compute a pure species property. The available properties consist of both parameters and functions. Some examples of available parameters are molar mass, Lennard Jones diameter, and dipole moment. Some examples of available functions are density, enthalpy, heat capacity, and viscosity. The property functions created are either dependent on temperature alone, or both on

temperature and pressure. For all property functions, the first order derivative with respect to temperature and, when applicable, with respect to pressure are automatically defined. The second-order derivatives with respect to temperature and pressure are available for property functions of density and molar volume.

Right-click the relevant **Thermodynamic System** node (see [Figure 10-8](#)), **Predefined System** node, or the relevant **External Thermodynamic System** node, and select **Species Property** () to start the **Species Property Wizard**.

The **Species Property Wizard** contains the following steps:

- 1 [Select Properties](#)
- 2 [Select Phase](#)
- 3 [Select Species](#)
- 4 [Species Property Overview](#)

SELECT PROPERTIES

First use the **Amount base unit** list to define the base unit. Select **mol** or **kg**.

Use the filter to search among the available properties. Select one or more properties in the list and click the **Add Selected** button () to add them to the **Selected properties** list.

Click the **Next** button (→) to proceed to the next step, selecting the phase.

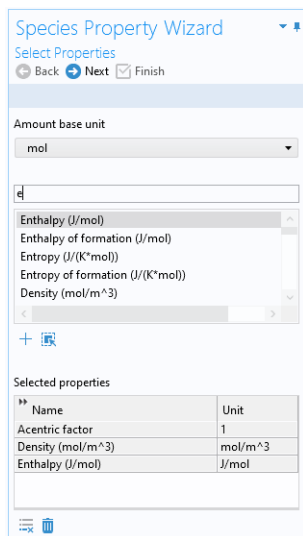

Figure 10-13: Species Property Wizard; Select Properties.

SELECT PHASE

Use the list to specify the phase for the species property. The available phases correspond to the ones defined for the thermodynamic system.

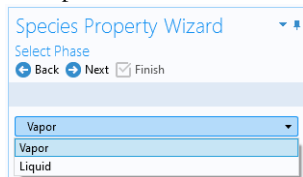



Figure 10-14: Species Property Wizard; Select Phase.

Note that for parameters (constants) this step is skipped.

Click the **Next** button (→) to proceed to the next step, selecting the species.

SELECT SPECIES

Select one or more of the species available in the thermodynamic system and use the **Add Selected** button (+) to add them to the **Selected species** table. One property function is created for each of the selected species.

Click the **Next** button () to proceed to the Species Property Overview in the wizard.

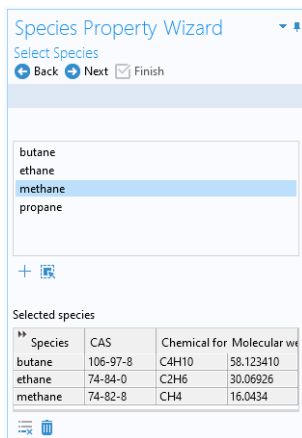



Figure 10-15: Species Property Wizard; the Select Species step.

SPECIES PROPERTY OVERVIEW

The final step of the wizard presents an overview of the parameters and functions defined for the corresponding property. Click the **Finish** button () to exit the wizard and add the species property to the current thermodynamic system.

THE SPECIES NODE UNDER A SYSTEM

When creating a species properties, the resulting parameters and functions are collected under a node with the species name. You can create new functions from an existing species under the system. Right-click the species and select **Species Property** to start the **Species Property Wizard**.

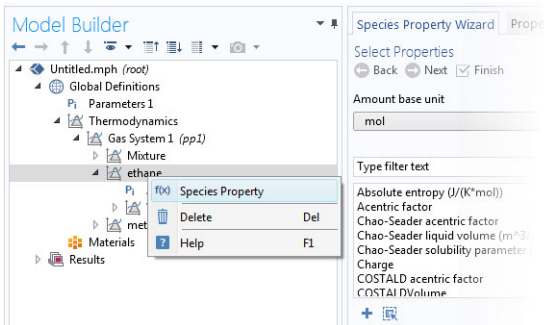

Figure 10-16: Create a Species Property from an existing species node.

SETTINGS

Selecting a **Species Property** node shows the settings for such property.

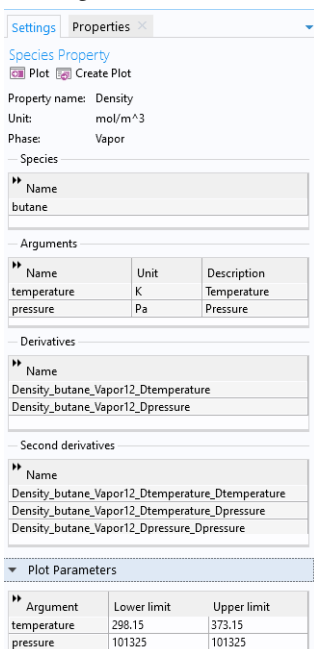

Figure 10-17: Species Property settings.

Definition:

Shows the definition of a property that is defined as a parameter or a function, for example the name of the parameter or function.



You can use the **Parameter name** or **Function name** fields to specify or change the name of a parameter or a function. The section also provides information about the property type and the species it is defined for.

For a parameter, this section also displays the numerical value.

For a function, this sections displays the arguments for the functions and the first order derivatives with respect to these arguments.

Plot Parameters

Available for property functions in order to plot a selected function for a given set of argument values.

Apply a **Lower limit** and an **Upper limit** for each argument, and click the **Plot** button () to plot the function using the given argument range. You can also click the **Create Plot** button () in order to create a plot group, under the **Results** node.

Properties Window

To see the reference for constant or temperature dependent functions, right-click on the function and select **Properties**. This opens the Properties window.

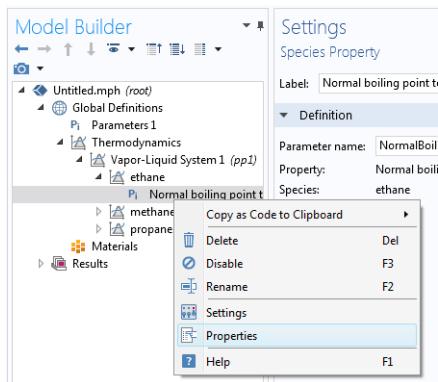

Figure 10-18: Show constant and temperature dependent properties references for species functions.

The reference for the constant or temperature dependent property is available in the **Comments** field in the **Node Properties** section.

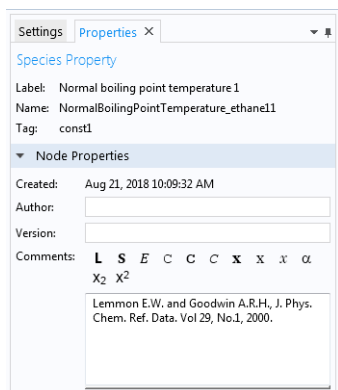

Figure 10-19: Properties window for species function.

Mixture Property

A **Mixture Property** is used to compute a property function that depends on the concentration of the species in a thermodynamic system. Some examples of the available property functions are density, enthalpy, heat capacity, and surface tension.

Apart from the composition, the mixture property functions are also dependent on temperature and pressure. The first-order derivatives with respect to temperature and pressure are automatically defined. The second-order derivatives with respect to temperature and pressure are available for property functions of density and molar volume.

Right-click the relevant **Thermodynamic System** node (see [Figure 10-8](#)), **Predefined System** node, or the relevant **External Thermodynamic System** node, and select **Mixture Property** to start the **Mixture Property Wizard**.

The **Mixture Property Wizard** contains the following steps:

- 1 [Select Properties](#)
- 2 [Select Phase](#)
- 3 [Select Species](#)
- 4 [Mixture Property Overview](#)

SELECT PROPERTIES

The settings in this step corresponds to those for [Select Properties](#) in the **Species Property Wizard**. Click the **Next** button () to proceed to the next step.

SELECT PHASE

Use this list to specify the phase, among the ones available in the system, for the selected mixture property.

Some properties require that the system consists of two phases, for example surface tension. A two-phase system may consist of a combination of liquid-vapor or liquid-liquid phases.

SELECT SPECIES

First select the **Species composition** base unit to be used for function arguments. Select **Mole fraction** or **Mass fraction**.

Select the species to be included in the list. Use the **Add All** button () to add all species in the thermodynamic system. It is also possible to select a subset of the

available species. In that case use the **Add Selected** button (+) to add species. The **Selected species** table is updated as you add species.

Click the **Next** button (→) to proceed to the next step in the wizard.

MIXTURE PROPERTY OVERVIEW

The final step of the wizard displays an overview of the functions that the wizard has added. Click the **Finish** button () to exit the wizard and add the properties to the current thermodynamic system.

SETTINGS

Selecting a desired **Mixture Property** node to display its settings window.

THE MIXTURE NODE UNDER A SYSTEM

When creating mixture properties, the resulting functions are collected under the **Mixture** node. You can create new functions from an existing **Mixture** node. Right-click the node and select **Mixture Property** from the context menu to start the **Mixture Property Wizard**.

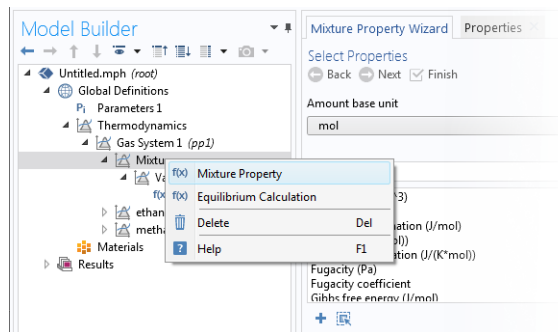

Figure 10-20: Mixture properties can be created by right-clicking a Mixture node under a thermodynamic system.

Equilibrium Calculation

The **Equilibrium Calculation** functionality is used to compute the resulting equilibrium conditions for a mixture of a set of species and phases.

Equilibrium calculations are often used for processes with vapor-liquid equilibrium (VLE), so-called flash calculations. A typical process that requires flash calculations is a distillation process, where a multiphase feed stream is separated into a vapor and a liquid product, and where the concentrations of the species in each phase are required.

Equilibrium calculations involve combining the VLE-equations with material balances for the chemical species, and in some cases with an energy balance. Flash calculations are typically used to obtain estimates of:

- Bubble point at given temperature.
- Bubble point at given pressure.
- Dew point at given temperature.
- Dew point at given pressure.
- Equilibrium conditions at given pressure and temperature.
- Equilibrium conditions at given pressure and enthalpy.
- Equilibrium conditions at given pressure and entropy.
- Equilibrium conditions at given internal energy and specific volume.

The last three examples are often considered more difficult, since they require energy balances and relations for computing enthalpy and entropy. Thermodynamics in COMSOL Multiphysics can handle all of the above cases using the equilibrium calculation functionality. Phase envelopes, bubble point, and dew point can be calculated for any number of species.

Right-click the relevant **Thermodynamic System** node (see [Figure 10-8](#)), **Predefined System** node, or the relevant **External Thermodynamic System** node, and select **Equilibrium Calculation** to start the **Equilibrium Calculation Wizard**.

The **Equilibrium Calculation Wizard** consists of the following steps:

- 1 [Select species](#)
- 2 [Equilibrium Specifications](#)
- 3 [Equilibrium Function Overview](#)

The **Equilibrium Calculation** settings include three types of equilibrium functions.

- The first function type is used to detect whether a phase is present in the system and includes “exist” in its name.
- The amount function computes the total amount of material in each phase.
- The phase composition functions compute the mass or mole fraction of each species in each phase, depending on the selected base unit for the equilibrium calculation.

SELECT SPECIES

Select one or more of the species available in the thermodynamic system and use the **Add Selected** button (+) to add them to the **Selected species** table. Click the **Next** button (→) to proceed to the next step in the wizard.

EQUILIBRIUM SPECIFICATIONS

Use the **Amount base unit** list to use either **kg** or **mol** as base unit.

Select two **Equilibrium conditions** that define the current equilibrium, for example a given pressure and a temperature. These equilibrium conditions are used as arguments in the equilibrium functions, in addition to the composition (overall fractions of species).

The available equilibrium conditions are: **Temperature**, **Pressure**, **Phase fraction**, **Energy** (or **Internal energy of formation**), **Enthalpy** (or **Enthalpy of formation**), **Specific volume**, **Density**, and **Entropy** (or **Entropy of formation**). For chemical reactions, it is recommended to use **Enthalpy of formation**, **Entropy of formation**, or **Internal energy of formation**, since they account for heat of reactions.

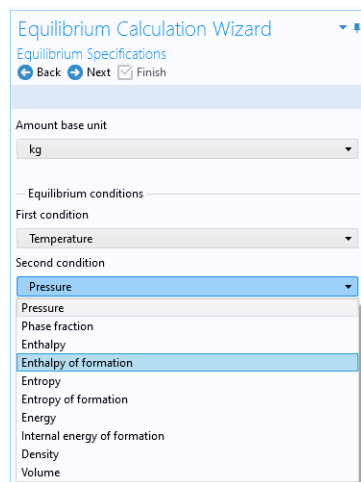

Figure 10-21: Equilibrium Calculation Wizard; Equilibrium Specifications.

Selecting **Phase fraction** as one of the equilibrium conditions activates the **Solution type** input field. This can be used to indicate the direction of the desired solution, which is of great use especially near critical points. The options **Undefined**, **Normal**, or **Retrograde** define different directions for the search of the solution to the equilibrium equations. Using **Normal** means that the derivative of the vapor phase fraction with respect to

temperature (at constant pressure and composition) is kept positive and the derivative of the vapor phase fraction with respect to pressure (at constant temperature and composition) is kept negative. Using **Retrograde** means that the opposite sign of the previous mentioned derivatives are enforced.

For a single species, the critical point is the highest pressure and temperature at which two phases (liquid and vapor) are distinguishable. However, for some multispecies systems, the critical point is a point between the dew point and the bubble point. In this case, the critical point does not represent the maximum pressure or the maximum temperature of vapor-liquid coexistence. This phenomenon is known as retrograde condensation. This means that under isothermal conditions, when the pressure decreases, some of the vapor condenses into liquid instead of expanding or vaporizing. An example of such system is formation of liquid hydrocarbons in a gas reservoir as the pressure decreases below the dew point pressure. In this case, setting **Solution type** to **Normal** or **Retrograde** may not be sufficient to distinguish between the two solutions.

Note that the **Solution type** setting is only available for a built-in thermodynamic systems. For external thermodynamic systems, the corresponding functionality needs to be supplied by the thermodynamic software provider. For instance, the COCO/TEA provider does not support the **Normal** or **Retrograde** options. In those cases, the **Solution type** should be **Undefined**.

Click the **Next** button () to proceed to the next step.

EQUILIBRIUM FUNCTION OVERVIEW

In this step, you can review all the functions including units and arguments. Click the **Finish** button () to exit the wizard and add functions at equilibrium state to the current thermodynamic system.

THE EQUILIBRIUM CALCULATION NODE

When creating an **Equilibrium Calculation**, the resulting functions are collected under the **Mixture** node. You can create new functions from an existing **Mixture** node. Right-click it and select **Equilibrium Calculation** to start the **Equilibrium Calculation Wizard** (see [Figure 10-20](#)).

SETTINGS

Selecting an **Equilibrium Calculation** node displays the settings including the property functions, see [Figure 10-22](#).

Plot Parameters:

Can be used to evaluate and plot the equilibrium function for a range of argument values. First specify which of the included functions to plot. Then apply a **Lower limit** and **Upper limit** for each argument and click the **Plot** button (🖨️).

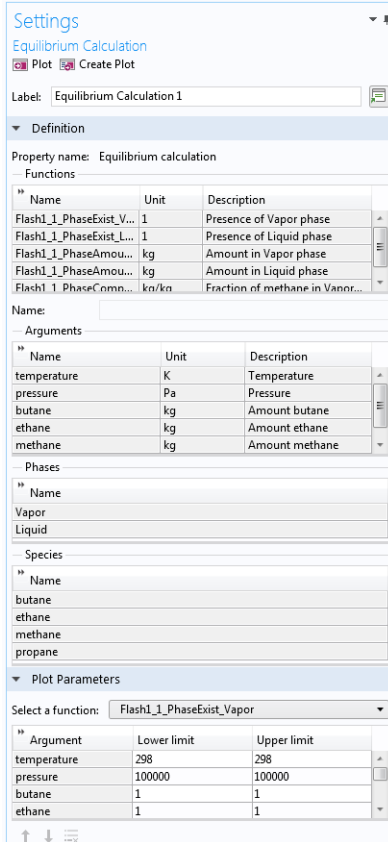

Figure 10-22: Settings window; Equilibrium calculation.

Generate Chemistry

The Chemistry interface includes functionality to automatically define and use mixture properties by interfacing to a Thermodynamic System node. How to manually set this coupling up is described in [Coupling with the Reaction Engineering and the Chemistry Interfaces](#).



The **Generate Chemistry Wizard** can be used to directly create a Chemistry interface from an existing Thermodynamics System node. The resulting Chemistry interface is automatically populated with the selected species, and is set up to be fully coupled to the thermodynamics. This means for example that functions for mixture properties, like the density enthalpy, are automatically defined and used in the generated Chemistry interface.

Right-click the relevant **Thermodynamic System** node, **Predefined System** node, or **External Thermodynamic System** node, and select **Generate Chemistry** to start the **Generate Chemistry Wizard**.

The **Generate Chemistry Wizard** contains the following steps:

- 1 [Select Species](#)
- 2 [Chemistry Settings](#)

SELECT SPECIES

Select the species to be included in the list. Use the **Add All** button () to add all species in the thermodynamic system. It is also possible to select a subset of the available species. In that case use the **Add Selected** button () to add species. The **Selected species** table is updated as you add species.

Click the **Next** button () to proceed to the next step in the wizard.

CHEMISTRY SETTINGS

The table at the top shows the selected species and their respective chemical formula. For each species, a corresponding Species feature will be added in the Chemistry interface. As an option, use the **Name in Chemistry** columns to specify another name of the species in Chemistry. This means that the species name could be different in Thermodynamics and Chemistry for a species. By default the chemical formula is used.

Component

Use the **Component** list to select the model component to which the Chemistry interface will be added. The already existing components are shown in the top of the list. A new component can be created by selecting the desired space dimension.

Mass Transfer

The **Mass transfer** list controls the intended mixture type for the Chemistry interface. Select **Diluted species** to model a mixture where the species are assumed diluted in a high concentration solvent. For this choice, also select **Solvent**. Optionally, select **Concentrated species** to model a mixture where all species are assumed to contribute to

the mixture properties. In the resulting Chemistry interface the **Type** setting in the Mixture Properties section is defined accordingly.

Phase

Select the Phase of the mixture from the **Phase** list. Included in the list are the phases available in the Thermodynamic System from which the Chemistry is generated.

Click the **Finish** button () to create the desired Chemistry interface and exit the wizard.

Generate Material

Once a thermodynamic system is defined, it can be used to define a multitude of property functions. The Generate Material option provides a fast route to defining the material properties most commonly required for fluid flow, heat transfer and mass transfer. By specifying the composition and the phase of the mixture, a Material node can automatically be set up. The material node can include properties such as the density, heat capacity, heat capacity ratio, thermal conductivity, viscosity, and the diffusivity. Two types of property functions can be used, either functions from the underlying thermodynamics or interpolation functions created from these. For space-dependent models, the interpolation models are more computationally efficient.

Right-click the relevant **Thermodynamic System** node (or an **External Thermodynamic System** node or **Predefined System** node), and select **Generate Material** to start the **Generate Material Wizard**.

The **Generate Material Wizard** contains the following steps:



- 1 [Select Phase](#)
- 2 [Select Species](#)
- 3 [Select Properties](#)
- 4 [Define Material](#)

SELECT PHASE

Use this list to specify the phase of the material. Select among the ones available in the system. This step of the Generate Material Wizard is not available for the **Predefined Systems Dry Air** and **Moist Air**.

Click the **Next** button () to proceed to the next step in the wizard.

SELECT SPECIES

Select the species to be included in the list. Use the **Add All** button () to add all species in the thermodynamic system. It is also possible to select a subset of the available species. In that case use the **Add Selected** button () to add species. The **Selected species** table is updated as you add species.

Notice that when using Generate Material for the **Predefined System Water-steam** this step is not included in the wizard.

Material Composition

Specify the mixture composition in terms of the **Mole fractions** or **Mass fractions** of all species. The fractions should sum to one. This setting is only available for systems with more than one component, and for materials with more than one selected species.

Click the **Next** button () to proceed to the next step in the wizard.

SELECT PROPERTIES

Use this step to select the material properties to be included.

For a liquid phase material the following properties are available:

- Density, (ρ)
- Diffusion coefficient at infinite dilution
- Heat capacity (C_p)
- Thermal conductivity (k)
- Viscosity (μ)

For a gas phase material, the Heat capacity ratio ($\gamma = C_p/C_v$) is also available.

To add a property to the **Selected properties** list click the **Add Selected** button ().

To remove properties, use the **Remove Selected** button () or the **Remove All** button ()

When adding the **Diffusion coefficient at infinite dilution**, also select which of the species is the solvent. The material will include one diffusion coefficient for each of the remaining (solute) species.

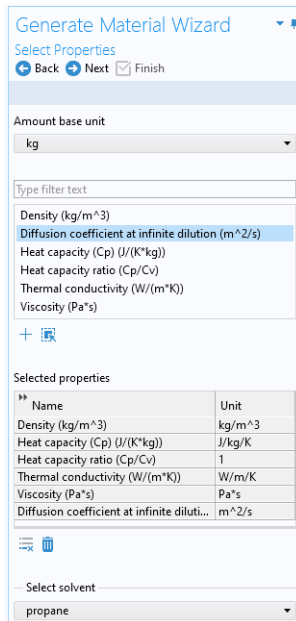

Figure 10-23: Generate Material Wizard; Select Properties with Diffusion coefficient at infinite dilution added.

Additional properties

The below additional properties are defined from the selected properties and added to the output properties of the material.

For a liquid phase material the isobaric coefficient of thermal expansion is defined as

$$\alpha_{\text{iso}} = -\frac{1}{\rho} \frac{\partial \rho}{\partial T} \quad (10-1)$$

For a gas phase material, the speed of sound c , and the isentropic compressibility χ_f are also defined as

$$c = \sqrt{\gamma \frac{\partial p}{\partial \rho}}, \quad \chi_f = \frac{1}{\gamma \rho} \frac{\partial \rho}{\partial p} \quad (10-2)$$

Click the **Next** button () to proceed to the next step.

DEFINE MATERIAL

Component

Use the **Component** list to select where the Material will be added. The already existing components are shown in the top of the list. A new component can be created by selecting the desired space dimension. Select **Global** at the end of the list to add the material under **Global Definitions**. A global material can be utilized in any component, through the use of a Material Link. It can also be used to define phase specific properties when linked to a subnode of a **Porous Material**.

Function Type

The material can be set up to use functions defined under the thermodynamics system, or interpolation functions defined from these. The interpolation functions are significantly faster to evaluate, especially for space dependent models, but requires that the temperature range and the pressure range are specified.

Select **Thermodynamics** to base the material properties on functions in the current thermodynamic system. The required functions are created, if not already present, and added to the system. When evaluating material properties, the underlying thermodynamics functions are called.

Select **Interpolation** to generate interpolation functions for the material properties. In this case the required functions are first created and added to the system. Next, the functions are evaluated in a number of sampling points over a given range, for both temperature and pressure. The result of the evaluation is stored and used to define interpolation functions for all material properties.

For the **Interpolation points**, select **Same for all functions** to use the same number of evaluation points for all functions. By selecting **Individual**, the number of evaluation points can be given per function. The latter can for example be used to increase the number of points for a function that is known to vary faster than the rest of the functions.

Select one of the preset levels for the **Maximum number of interpolation points**. This is used to provide a maximum size of the underlying data for the interpolation functions. If the total number of evaluation points for any function, varying temperature and pressure, is exceeded, a warning is shown.

Define the temperature range and pressure ranges for the temperature and pressure by providing the **Low** and **High** end values. To neglect the variation in either temperature or pressure, give the same value for the low and high end value. This can for example be used when the pressure variation is known to be negligible. For each range, also

define the number of evaluation points in the **Number of points** field. The underlying functions are evaluated at uniformly distributed positions across the temperature and pressure range.

When **Individual** has been selected for the **Interpolation points**, the **Ranges and interpolation points** can be specified per function to be created.

Click the **Finish** button () to create the specified Material and exit the wizard.

Coupling with the Reaction Engineering and the Chemistry Interfaces

Using the **Reaction Engineering** or **Chemistry** interfaces, all species property parameters and property functions required by these interfaces can be created automatically by coupling to an existing **Thermodynamic System**, **Predefined System**, or **External Thermodynamic System** under **Thermodynamics**. Examples of species properties that can be created automatically are molar mass, heat capacity, enthalpy, and entropy for each species. Parameters and functions for these properties are created by the thermodynamic system. The **Reaction Engineering** and **Chemistry** interfaces can also be used to define transport properties for the resulting mixture (all species in the interface). When coupled, the following mixture properties can be automatically created: heat capacity, density, thermal conductivity, and dynamic viscosity.



The Reaction Engineering interface and the Chemistry interface are only available in a limited set of add-on products. See <https://www.comsol.com/products/specifications/> for more details on availability.

Note that using a thermodynamic system significantly increases the modeling capabilities in the **Reaction Engineering** and **Chemistry** interfaces. All ideal and nonideal thermodynamic models, for gases and liquids, are directly available and also automatically updated by editing the settings for the thermodynamic system in use. The **Chemistry** interface can furthermore be used to make the mixture properties readily available in space-dependent models for modeling of mass transport, heat transfer, or fluid flow.

REACTION ENGINEERING

Mixture Properties

You can couple a Reaction Engineering interface with an existing thermodynamic system in the **Reaction Engineering** interface's settings window.

You need to have at least one species defined in the Reaction Engineering interface in order to couple it to a thermodynamic system. You can make this coupling in the Settings window for the **Reaction Engineering** interface by selecting the **Thermodynamics** check box in the **Mixture Properties** section.

Select a thermodynamic system from the **Thermodynamic system** list. Use the **Phase** list to select the phase to be used in the **Reaction Engineering** interface.

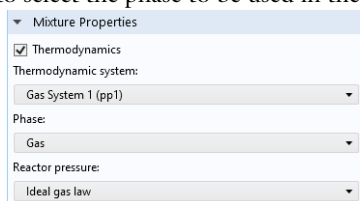

▼ Mixture Properties

Thermodynamics

Thermodynamic system:

Gas System 1 (pp1) ▼

Phase:

Gas ▼

Reactor pressure:

Ideal gas law ▼

Figure 10-24: Coupling Reaction Engineering Interface with Thermodynamics.

Species Matching

The **Species Matching** section is activated when the **Thermodynamics** check box is selected in the **Mixture Properties** section; see above. The species in the Reaction Engineering interface can be matched to a species in the thermodynamic system. This step ensures that the arguments in the thermodynamic system functions are correctly defined.

Use the lists in the **From Thermodynamics** column to match each species in the interface to a species in the coupled thermodynamic system.

For each species matched, the required property parameters and functions are added under to the corresponding thermodynamic system.

When all species are matched, the interface is considered fully coupled and functions representing mixture properties, such as density, are also added automatically under the corresponding thermodynamic system.

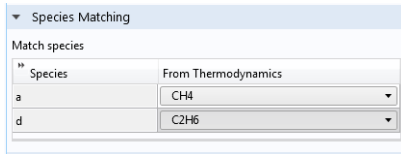

Figure 10-25: Matching the species in Reaction Engineering to those in the corresponding thermodynamic system.

Calculate Transport Properties

When the interface is fully coupled to a thermodynamic system, property functions for the mixture transport properties are created automatically when the **Calculate mixture properties** check box is selected. The properties calculated by the thermodynamic system display **Thermodynamics** in the corresponding list; see below.

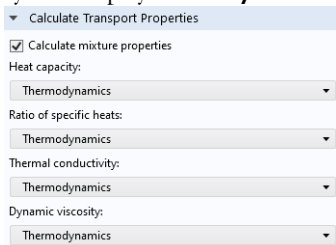

Figure 10-26: Select the Calculate mixture properties check box when coupled to a thermodynamic system.

CHEMISTRY

Mixture Properties

You can couple a Chemistry interface with an existing thermodynamic system in the **Chemistry** interface's settings window. You can make this coupling in the Settings window for the **Chemistry** interface by selecting the **Thermodynamics** check box in the **Mixture Properties** section. You need to have at least one species defined in the Chemistry interface in order to couple it to a thermodynamic system.

Select a thermodynamic system from the **Thermodynamic system** list. Use the **Phase** list to select the phase to be used in the **Chemistry** interface.

Species Matching

The **Species Matching** section is activated when the **Thermodynamics** check box is selected in the **Mixture Properties** section. Here you can match the variables for the concentrations, and by this calculate mixture properties (transport and thermodynamic properties). For information on how to specify the dependent variables to be used, see [Species Matching](#) in [The Chemistry Interface](#) documentation.

You can match the species in the Chemistry interface with those in the corresponding thermodynamic system in the **Species matching** section's table. Use the lists in the column with the title **From Thermodynamics** to match each species in the Chemistry interface to a species in the corresponding thermodynamic system. This ensures that the composition function arguments in the thermodynamic system are correctly defined.

For each species matched, the species property parameters and functions required by the Chemistry interface are automatically created and added under the corresponding thermodynamic system.

When all species are matched, the interface is fully coupled to Thermodynamics and functions representing mixture properties, such as the density, are added automatically under the thermodynamic system that the interface is coupled to.

The screenshot shows a software interface with two main sections: "Mixture Properties" and "Species Matching".

Mixture Properties

- Type: Diluted species (dropdown)
- Thermodynamics
- Thermodynamic system: Dry Air 1 (pp1) (pp1) (dropdown)
- Phase: Gas (dropdown)
- Density: Thermodynamics (dropdown)

Species Matching

– Bulk species

Species	Species conce	Molar concentration (mol/m ³)	From Thermodynamics
Ar	Free species	cAr	Ar (dropdown)

Figure 10-27: Matching concentration variables in a Chemistry interface, as well as species in a coupled Thermodynamic System.

Calculate Transport Properties

When the interface is fully coupled to a thermodynamic system, property functions for the mixture transport properties are created automatically when the **Calculate mixture properties** check box is selected. The properties calculated by the thermodynamic system display **Thermodynamics** in the corresponding list; see [Figure 10-26](#).

MIXTURE PROPERTY DEFINITIONS WHEN COUPLING TO THERMODYNAMICS

When all species in a physics interface (**Reaction Engineering** or **Chemistry**) are matched to the corresponding species in a thermodynamic system, the mixture properties are calculated based on the composition of the mixture. For example, consider $Z_{\text{mix}}(T, P, n_1, \dots, n_m)$, which denotes a generic extensive mixture property for a mixture of m number of species. The property function's arguments are the temperature T , the pressure P , and the number of moles, n , for each species.

When the system is fully matched, the mixture property Z_{mix} is defined as

$$Z_{\text{mix}} = \sum_{i=1}^m n_i \bar{Z}_i \quad (10-3)$$

where \bar{Z}_i is the partial molar of species i :

$$\bar{Z}_i = \left(\frac{\partial Z_{\text{mix}}(T, P, n_1, n_2, \dots, n_m)}{\partial n_i} \right)_{T, P, n_{j \neq i}} \quad (10-4)$$

The definition of partial molar properties can be rewritten using mole fraction derivatives as:

$$\bar{Z}_i(T, P, n_1, \dots, n_m) = \bar{Z}_i(T, P, x_1, \dots, x_m) = \quad (10-5)$$

$$\left(Z_{\text{mix}}(T, P, x_1, \dots, x_m) + \left(\frac{\partial Z_{\text{mix}}(T, P, x_1, \dots, x_m)}{\partial x_i} \right)_{T, P, x_{j \neq i}} - \sum_{i=1}^m \left(x_i \left(\frac{\partial Z_{\text{mix}}(T, P, x_1, \dots, x_m)}{\partial x_i} \right)_{T, P, x_{j \neq i}} \right) \right)$$

When the system is partially coupled, which means that some but not all species have been coupled, the mixture property is instead calculated assuming ideal mixing:

$$Z_{\text{mix}} = \sum_{i=1}^m n_i Z_i(T, P) \quad (10-6)$$

using the pure species properties $Z_i = Z_{\text{mix}}(T, P, x_i = 1, 0, \dots, 0)$.

Evaluating a Property Function in a Physics Interface

The functions set up using a thermodynamic system in Thermodynamics can be used directly in any physics interfaces in COMSOL Multiphysics, in the same way as for standard functions. Simply type in the function name with the proper arguments in the appropriate field of the model to use the function. [Figure 10-28](#) shows an example of this from the Reaction Engineering interface. In this example, the **Species Thermodynamic Expressions** section gets input for the molar entropy, the enthalpy and the heat capacity of toluene. These functions, generated using **Species Property** for a thermodynamic system containing toluene, have been entered in the corresponding input fields using the appropriate arguments.

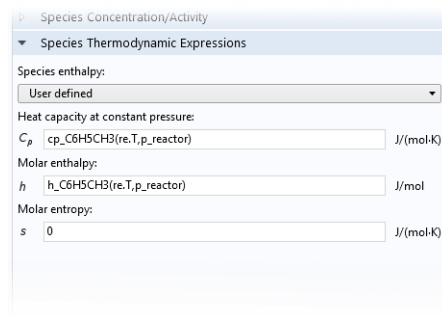

Figure 10-28: The enthalpy and heat capacity of toluene are evaluated using property calculations through a thermodynamics system. In this case, the functions are temperature and pressure dependent properties for a pure component.

User-Defined Species

Use this feature to specify the properties of a new species not available in the included COMSOL database. This feature can also be used to edit a database species, by using an existing species as a template, to create a new one. A User-Defined Species can be included in a Thermodynamic System feature, or Predefined System feature, together with predefined database species and other user-defined species.

The data needed for a user-defined species includes both material properties, such as the molar mass and the vapor pressure, and properties for specific thermodynamic models or transport models (see [Thermodynamic Models and Theory](#)). For instance, in order to use the **UNIFAC** thermodynamic model, you need to define UNIFAC groups for the new species.

Note that the thermodynamics calculator includes measures to handle missing species properties, sometimes by applying approximations. For instance, if the Wilson volume

is not available, the liquid volume at normal boiling point is used instead. If data for this is also missing, it is estimated from the saturated liquid density correlation.

When creating a user-defined species it is recommended to add the following common material properties:

- Molecular mass
- Critical properties
- Acentric factor
- Absolute entropy
- Standard enthalpy of formation
- Ideal gas heat capacity
- Vapor pressure
- Heat of vaporization
- Saturated liquid density
- Transport properties

EXAMPLE MODEL

For an example of using a User-Defined Species see this application example:



Dissociation in a Tubular Reactor: Application Library path
Chemical_Reaction_Engineering_Module/Thermodynamics/dissociation

THE USER-DEFINED SPECIES WIZARD

To create a **User-Defined Species**, start the **User-Defined Species Wizard** in one of the following ways:

- Right-click the **Global Definitions** node, select **Thermodynamics** and choose **User-Defined Species**.
- If the model already includes the **Thermodynamics** node, right-click it and choose **User-Defined Species**.
- Using the **Reaction Engineering** or **Chemistry** interface, choose **User-Defined Species** from the **Thermodynamics** section of the **Reaction Engineering** or **Chemistry** toolbar.

The **User-Defined Species Wizard** contains the following steps:

- 1 Enter Name and Formula
- 2 Enter Parameters

3 Define Properties

ENTER NAME AND FORMULA

Enter the **Name**, **CAS** number, and the **Chemical formula** for the new species.

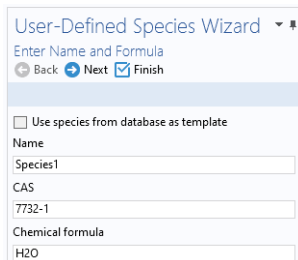

The screenshot shows the 'User-Defined Species Wizard' dialog box in the 'Enter Name and Formula' step. At the top, there are navigation buttons: 'Back' (disabled), 'Next' (active), and 'Finish' (checked). Below this is a checkbox labeled 'Use species from database as template' which is currently unchecked. Underneath, there are four text input fields: 'Name' (containing 'Species1'), 'CAS' (containing '7732-1'), 'Chemical formula' (containing 'H2O'), and an empty field.

Figure 10-29: User-Defined Species Wizard; Enter Name and Formula.

If you want to edit a species in the COMSOL database, select the **Use species from database as template** check box. Then locate the species to edit in the list. The filter text field can be used to search among the available species.

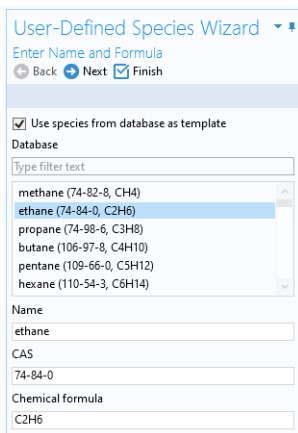

The screenshot shows the 'User-Defined Species Wizard' dialog box in the 'Enter Name and Formula' step. The 'Use species from database as template' checkbox is now checked. Below it is a 'Database' section with a 'Type filter text' input field. A list of species is displayed, with 'ethane (74-84-0, C2H6)' selected. Below the list are four text input fields: 'Name' (containing 'ethane'), 'CAS' (containing '74-84-0'), 'Chemical formula' (containing 'C2H6'), and an empty field.

Figure 10-30: User-Defined Species Wizard; edit an available species by selecting Use species from database as template.

Click the **Next** button () to proceed to the next step.

ENTER PARAMETERS

Define the necessary parameter for the new species.

Constants

Use this table to define material constants such as molar mass, critical temperature, and standard enthalpy of formation.

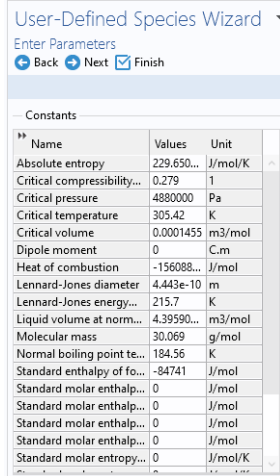

The screenshot shows the 'User-Defined Species Wizard' in the 'Enter Parameters' step. It features a navigation bar with 'Back', 'Next', and 'Finish' buttons. Below is a table titled 'Constants' with columns for Name, Values, and Unit.

Name	Values	Unit
Absolute entropy	229.650...	J/mol/K
Critical compressibility...	0.279	1
Critical pressure	4880000	Pa
Critical temperature	305.42	K
Critical volume	0.0001455	m ³ /mol
Dipole moment	0	C.m
Heat of combustion	-156088...	J/mol
Lennard-Jones diameter	4.443e-10	m
Lennard-Jones energy...	215.7	K
Liquid volume at norm...	4.39590...	m ³ /mol
Molecular mass	30.069	g/mol
Normal boiling point te...	184.56	K
Standard enthalpy of fo...	-84741	J/mol
Standard molar enthalp...	0	J/mol
Standard molar enthalp...	0	J/mol
Standard molar enthalp...	0	J/mol
Standard molar enthalp...	0	J/mol
Standard molar enthalp...	0	J/mol
Standard molar entrop...	0	J/mol/K

Figure 10-31: User-Defined Species Wizard; Enter material constants.

Structure information

If you want to use the UNIFAC model, specify the structure formula, the UNIFAC groups and their number occurrences.

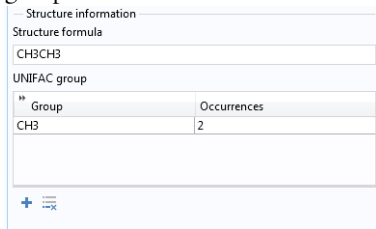

The screenshot shows the 'Structure information' section of the 'User-Defined Species Wizard'. It includes a text field for the 'Structure formula' containing 'CH3CH3'. Below is a table for 'UNIFAC group' with columns for Group and Occurrences.

Group	Occurrences
CH3	2

Figure 10-32: User-Defined Species Wizard; Specify the structure information in the Enter Parameters step.

Model parameters

Specify the parameters for the thermodynamic models and transport models in use.

Model parameters		
Name	Values	Unit
Chao-Seader acentric factor	0.1064	1
Chao-Seader liquid volume	6.8e-05	m ³ /mol
Chao-Seader solubility parameter	12379.3085701	J ^{0.5} /m ^{1.5}
COSTALAD acentric factor	0.0983	1
COSTALAD volume parameter	0.0001458	m ³ /mol
Peng-Robinson Twu L	0.311041	1
Peng-Robinson Twu M	0.866279	1
Peng-Robinson Twu N	1.29869	1
Rackett parameter	0.2808	1
Solubility parameter	13500	J ^{0.5} /m ^{1.5}
UNIQUAC Q parameter	1.696	1
UNIQUAC R parameter	1.802	1
Wilson volume parameter	0	m ³ /mol

Figure 10-33: User-Defined Species Wizard; Specify model parameters.

Click the **Next** button (→) to proceed to the next step.

DEFINE PROPERTIES

The last step in the wizard is to add temperature dependent properties for the new species. All temperature dependent properties are defined using cubic polynomials on the form

$$f(T) = a_0 + a_1T + a_2T^2 + a_3T^3 \quad (10-7)$$

Each property can consist of an arbitrary number of temperature intervals, each using the above form. Click the **Add** button (+) under the table for a specific property to add an interval.

The following temperature dependent properties are necessary in order to compute the basic set of mixture properties when including the **User-Defined Species** in a thermodynamic system:

- Ideal gas heat capacity
- Liquid density
- Vapor pressure
- Heat of vaporization

Note that some thermodynamic properties, such as the enthalpy and entropy, of a species or mixture, are estimated from the ideal gas heat capacity and depends on the thermodynamic model applied for the system (see [Thermodynamic Properties Definitions](#)).

Click the **Finish** button () in the top of the Settings window to finalize the species and add it to the **User-Defined Species** node under **Thermodynamics**.

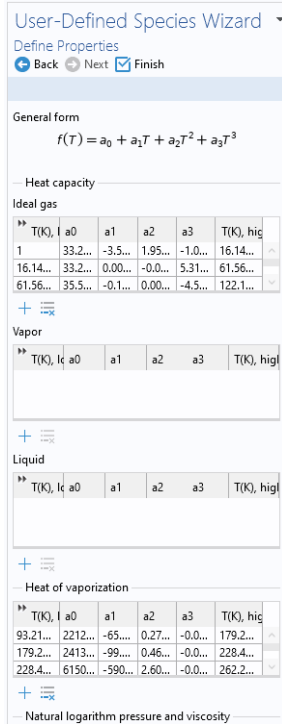

Figure 10-34: User-Defined Species Wizard; specify temperature-dependent properties.

SETTINGS

Selecting a species node under **User-Defined Species** shows the Settings window including the definitions of all species properties. Properties are categorized into sections as seen in Figure 10-35 below. All properties can be edited by expanding the corresponding section.



When a species properties has been changed, any **Thermodynamic System** that includes the species needs to be updated for the changes to take effect (see [Update From Species](#)).

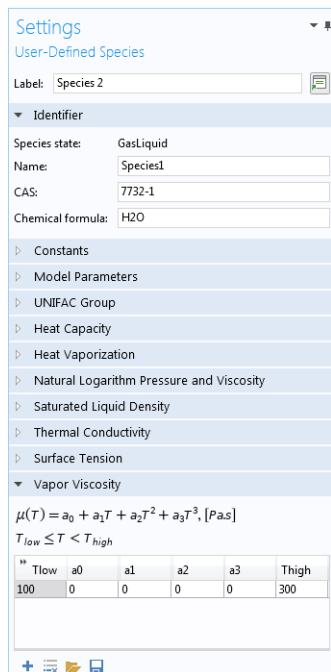

Figure 10-35: The Settings window for a User-Defined Species.

References

1. www.colan.org
2. Cape Open to Cape Open Simulation Environment, www.cocosimulator.org/index_download.html

Thermodynamic Models and Theory

In this section:

- [Introduction](#)
- [Thermodynamic Models](#)
- [Selecting the Right Thermodynamic Model](#)
- [Species Property References](#)
- [Thermodynamic Properties Definitions](#)
- [Standard Enthalpy of Formation and Absolute Entropy Terms](#)
- [Reference State](#)
- [Transport Properties](#)
- [Surface Tension](#)
- [References](#)

Introduction

In this chapter, we review the theory behind the thermodynamic properties database and its functions. The thermodynamic models in the database are available for single phase, gas or liquid, and phase equilibrium systems for two or more phases such as vapor-liquid equilibrium (VLE), vapor-liquid-liquid equilibrium (VLLE) and liquid-liquid equilibrium (LLE).

Thermodynamic Models

In the following sections, the available thermodynamic models are described:

- [Equation of State Models](#)
- [Liquid Phase Models](#)

EQUATION OF STATE MODELS

An equation of state (EOS) model is an algebraic relation between the absolute pressure (P), the molar volume (V), and the absolute temperature (T). An equation of state that is at least cubic in volume and in the form of

$$Z \equiv \frac{PV}{RT} = f_v(V, T) \quad (10-8)$$

where Z is the compressibility factor and R the universal gas constant, can be used to describe both gases and liquids. The cubic equations of state are widely used to describe the gaseous and liquid volumetric behavior of pure fluids and also all other properties with extensions to mixtures. A comprehensive comparison of different cubic EOS models can be found in [Ref. 2](#) and [Ref. 3](#).

The equations of state models available in the thermodynamic properties database are:

- [Ideal Gas Law](#)
- [Peng–Robinson](#)
- [Peng–Robinson \(Twu\)](#)
- [Soave–Redlich–Kwong](#)
- [Soave–Redlich–Kwong \(Graboski–Daubert\)](#)
- [Water \(IAPWS\)](#)

Ideal Gas Law

The ideal gas law equation of state is

$$P = \frac{RT}{V} \quad (10-9)$$

As the name suggests, the ideal gas law is only applicable to gases. In fact, its use is limited to gases at low to moderate pressures.

Peng–Robinson

The classical Peng–Robinson (PR) equation of state [Ref. 5](#) is given by

$$P = \frac{RT}{V-b} - \frac{a\alpha}{V^2 + 2bV - b^2} \quad (10-10)$$

where for species i ,

$$a_i = \Omega_A \frac{R^2 T_c^2}{P_c} \quad (10-11)$$

$$b_i = \Omega_B \frac{RT_c}{P_c} \quad (10-12)$$

$$\Omega_A = \frac{1}{3} + \frac{1}{3}\Omega_B(4 + 10\Omega_B) \quad (10-13)$$

$$\Omega_B = \left(\beta - \frac{63}{1024\beta} - 0.03125 \right) \quad (10-14)$$

$$\beta = \left(\frac{351}{32768} + \frac{27}{2048} \sqrt{2} \right)^{\frac{1}{3}} \quad (10-15)$$

The alpha function, α_i , is given by

$$\alpha_i = [1 + (0.37464 + 1.54226\omega_i - 0.26992\omega_i^2)(1 - \sqrt{T_{r,i}})]^2 \quad (10-16)$$

For mixtures

$$a\alpha = \sum_i \sum_j x_i x_j (1 - k_{PR,i,j}) \sqrt{(a\alpha)_i (a\alpha)_j} \quad (10-17)$$

$$b = \sum_i x_i b_i \quad (10-18)$$

The binary interaction parameters (BIPs), k_{PR} , are symmetric with zeros in the diagonal:

$$k_{PR} = k_{PR,i,j} \quad (10-19)$$

$$k_{PR,i,j} = 0 \quad (10-20)$$

When binary interaction parameters are missing in the database for a set of species, the value is set to zero (a warning node is created). The values for critical temperature, T_c , critical pressure, P_c , and acentric factor, ω_i must be specified for all species.

Peng–Robinson (Twu)

For the Twu modification (Ref. 6) of the Peng–Robinson model, the alpha function, α_i , is replaced by

$$\alpha_i = T + R^{(N_i(M_i - 1))} \exp(L_i(1 - T_{r,i}^{N_i M_i})) \quad (10-21)$$

The binary interaction parameters k_{PR} , are used for the Twu modification. Acentric factor, ω_i , is not used in this model but critical temperature and critical pressure must be specified for all species. The species specific fit parameters L_i , M_i , N_i can be determined by fitting the pure species phase equilibrium to the vapor pressure curve.

Soave–Redlich–Kwong

The classical Soave–Redlich–Kwong equation of state [Ref. 7](#) is given by

$$P = \frac{RT}{V-b} - \frac{a\alpha}{V(V+b)} \quad (10-22)$$

with

$$\alpha = \frac{1}{\sqrt{T}} \quad (10-23)$$

and for the pure species i ,

$$a_i = \Omega_A \frac{R^2 T_c^{2.5}}{P_c} \quad (10-24)$$

$$b_i = \Omega_B \frac{RT_c}{P_c} \quad (10-25)$$

$$\Omega_A = \frac{1}{3} + \frac{1}{3}\Omega_B(3 + 3\Omega_B) \quad (10-26)$$

$$\Omega_B = \frac{1}{27}2^{\frac{1}{3}}27^{\frac{2}{3}} - \frac{1}{3} \quad (10-27)$$

For mixtures

$$a = \sum_i \sum_j x_i x_j (1 - k_{\text{SRK},i,j}) \sqrt{a_i a_j} \quad (10-28)$$

$$b = \sum_i x_i b_i \quad (10-29)$$

The binary interaction parameters, k_{SRK} , are symmetric with zero in the diagonal:

$$k_{\text{SRK},i,j} = k_{\text{SRK},j,i} \quad (10-30)$$

$$k_{\text{SRK},i,i} = 0 \quad (10-31)$$

If a value is missing for $k_{\text{SRK},i,j}$ in the database, it is set to zero (a warning note is created). The values for critical temperature, T_c , critical pressure, P_c , and acentric factor, ω_i , must be specified for all species. The Soave–Redlich–Kwong equation of

state is a version of [Equation 10-22](#) modified by Soave [Ref. 8](#), where for pure species i , the alpha function is modified to

$$\alpha_i = [1 + (0.480 + 1.574\omega_i - 0.176\omega_i^2)(1 - \sqrt{T_{r,i}})]^2 \quad (10-32)$$

Soave–Redlich–Kwong (Graboski–Daubert)

The Graboski and Daubert [Ref. 9](#) modification of the Soave–Redlich–Kwong equation of state replaces alpha function by

$$\alpha_i = [1 + (0.48508 + 1.55174\omega_i - 0.1561\omega_i^2)(1 - \sqrt{T_{r,i}})]^2 \quad (10-33)$$

except for H_2 , where it is replaced by

$$\alpha_{H_2} = 1.202 \exp(-0.30228T_{r,H_2}) \quad (10-34)$$

Water (IAPWS)

The International Association for the Properties of Water and Steam (IAPWS) provides a set of correlations to compute properties of water in different states. The correlations available in COMSOL correspond to the version named Industrial Formulation 1997 (IF-97) [Ref. 10](#) - [Ref. 12](#). The correlations are valid in the following ranges:

$$273.15 \text{ K} \leq T \leq 1073.15 \text{ K} \quad p \leq 100 \text{ MPa} \quad (10-35)$$

$$1073.15 \text{ K} \leq T \leq 2273.15 \text{ K} \quad p \leq 50 \text{ MPa} \quad (10-36)$$

The following water and steam properties, available by creating a [Species Property](#), are computed using the IAPWS correlations: density, volume, enthalpy, internal energy, Helmholtz energy, heat capacity at constant pressure, and heat capacity at constant volume. The amounts present in the vapor and liquid phase can be computed using an [Equilibrium Calculation](#).

Other parameters and thermodynamic properties available for the system are provided from the COMSOL database.

LIQUID PHASE MODELS

Activity coefficient models

Activity coefficient models are used to describe liquid mixtures at low to moderate pressures and temperatures where the equations of state are inadequate. When using activity coefficient models, the partial fugacity for species i in the liquid phase is defined as

$$\hat{f}_{i,l} = x_i \gamma_i \phi_{i,\text{sat}} P_{i,\text{sat}} F_i \quad (10-37)$$

which yields

$$\hat{\phi}_{i,l} = \gamma_i \phi_{i,\text{sat}} \frac{P_{i,\text{sat}}}{P} F_i \quad (10-38)$$

where the activity coefficient, γ_i , describes the nonideal liquid phase and $\hat{\phi}_{i,\text{sat}} P_{i,\text{sat}}$ is the fugacity at the vapor-liquid phase boundary at equilibrium for the pure species i . The Poynting correction, F_i , describes the pure species fugacity deviation from the boiling curve and can be expressed as

$$F_i = \exp\left(\int_{P_{i,\text{sat}}}^P \frac{V_{i,l}}{RT} dp\right) \quad (10-39)$$

For an incompressible liquid, an approximation of the Poynting correction can be done according to

$$F_i \approx \exp\left(\frac{V_{i,l}}{RT}(P - P_{i,\text{sat}})\right) \quad (10-40)$$

The Poynting correction can often be ignored for moderate pressure. Hence, Equation 10-38 can be expressed as

$$\hat{\phi}_{i,l} = \gamma_i \phi_{i,\text{sat}} \frac{P_{i,\text{sat}}}{P} \quad (10-41)$$

If the vapor phase is considered ideal, then $\phi_{i,\text{sat}} = 1$ and the above equation reduces to

$$\hat{\phi}_{i,l} = \gamma_i \frac{P_{i,\text{sat}}}{P} \quad (10-42)$$

This reduction can be selected explicitly in case the vapor phase is not ideal.

The logarithmic transformation of Equation 10-38 is:

$$\ln \hat{\phi}_{i,l} = \ln \gamma_i + \ln \phi_{i,\text{sat}} + \ln P_{i,\text{sat}} - \ln P + \ln F_i \quad (10-43)$$

Ideal Solution

For an ideal solution the activity coefficient is equal to one, which gives:

$$\ln \gamma_i = 0 \quad (10-44)$$

Regular Solution

The Scatchard–Hildebrand equation [Ref. 14](#) for a nonpolar mixture is

$$\ln \gamma_i = \frac{V_i(\delta_i - \delta_{av})^2}{RT} \quad (10-45)$$

where V_i is species molar volume and δ_i is species solubility parameter, and δ_{av} is

$$\delta_{av} = \frac{\sum_i (x_i V_i \delta_i)}{\sum_i (x_i V_i)} \quad (10-46)$$

The volume parameter, V_i , is set equal the liquid volume, $V_{i,l,b}$ at normal boiling point which must be specified for all species. The solubility parameter, δ_i must be specified for all species and can be estimated from the normal heat of vaporization, $\Delta H_{\text{vap},i}$ and the liquid volume at normal boiling point as below:

$$\delta_i \equiv \sqrt{\frac{\Delta H_{\text{vap},i}}{V_{i,l,b}}} \quad (10-47)$$

Extended Regular Solution

The extended Scatchard–Hildebrand equation adds the Flory and Huggins correction to the regular solution model [Ref. 16](#):

$$\ln \gamma_i = \frac{V_i(\delta_i - \delta_{av})^2}{RT} + \ln(\theta_i) + 1 - \theta_i \quad (10-48)$$

where

$$\theta_i = \frac{V_i}{\sum_i (x_i V_i)} \quad (10-49)$$

Wilson

Wilson [Ref. 17](#) derived his activity coefficient model from a consideration of probabilities of neighboring molecules in a liquid

$$\ln \gamma_i = 1 - \sum_j \left(\frac{x_j \Lambda_{j,i}}{\sum_k x_k \Lambda_{j,k}} \right) - \ln \left(\sum_j x_j \Lambda_{i,j} \right) \quad (10-50)$$

$$\Lambda_{i,j} = \frac{V_{w,j}}{V_{w,i}} \exp\left(-\frac{\lambda_{i,j}}{T}\right) \quad (10-51)$$

where the Wilson volume parameter, $V_{w,i}$, is a species-specific parameter describing volume. If the volume parameter is not available, the liquid volume at normal boiling point is used. The Wilson binary interaction parameters $\lambda_{i,j}$ are specified in terms of absolute temperature. The binary interaction parameter matrix is nonsymmetric and with zeros in its diagonal. All off-diagonal values must be specified

$$\lambda_{i,i} = 0 \quad (10-52)$$

$$\Lambda_{i,i} = 1 \quad (10-53)$$

NRTL

Renon and Prausnitz (Ref. 18) formulated a three parameter activity coefficient model that is able to describe liquid-liquid equilibrium; the nonrandom two-liquid (NRTL) model:

$$\ln \gamma_i = \frac{\sum_j x_j \tau_{j,i} G_{j,i}}{\sum_j x_j G_{j,i}} + \sum_j \left(\frac{x_j G_{j,i}}{\sum_k x_k G_{k,j}} \left(\tau_{i,j} - \frac{\sum_k x_k \tau_{k,j} G_{k,j}}{\sum_k x_k G_{k,j}} \right) \right) \quad (10-54)$$

$$\tau_{i,j} = \frac{A_{i,j}}{T} \quad (10-55)$$

$$G_{i,j} = \exp(-\alpha_{i,j} \tau_{i,j}) \quad (10-56)$$

The three parameters are $A_{i,j}$, $A_{j,i}$, and $\alpha_{i,j}$. A more general form is implemented here:

$$\tau_{i,j} = \frac{A_{i,j}}{T} + B_{i,j} \quad (10-57)$$

$$G_{i,j} = \exp(\beta_{i,j} - \alpha_{i,j} \tau_{i,j}) \quad (10-58)$$

The binary interaction parameters, $A_{i,j}$, are specified in terms of absolute temperature. The diagonal values are zero and the matrix is nonsymmetric. All off-diagonal values must be specified.

The binary interaction parameters, $B_{i,j}$, have values of zero on the diagonal and the matrix is nonsymmetric. For each pair of species, at least $A_{i,j}$ or $B_{i,j}$ should be specified.

The randomness parameters, $\alpha_{i,j}$, have values of zero on the diagonal and the matrix is symmetric. All off-diagonal values must be specified. Alternatively one can set the more generic form directly specifying parameter $\beta_{i,j}$ for which diagonal values are zero and the matrix is nonsymmetric. For each pair of species at least $\alpha_{i,j}$ or $\beta_{i,j}$ should be specified.

If any value for these parameters is missing in the database, it is set to zero (warning node is created).

$$A_{i,i} = 0 \quad (10-59)$$

$$B_{i,i} = 0 \quad (10-60)$$

$$\alpha_{i,i} = 0 \quad (10-61)$$

$$\alpha_{j,i} = \alpha_{i,j} \quad (10-62)$$

$$\tau_{i,i} = 0 \quad (10-63)$$

$$G_{i,i} = 1 \quad (10-64)$$

$$\beta_{i,i} = 0 \quad (10-65)$$

UNIQUAC

Abrams and Prausnitz followed up with another two-liquid model known as Universal Quasi Chemical equation (UNIQUAC) (see [Ref. 19](#)), which is formulated in terms of two activity coefficients:

$$\ln \gamma_i = \ln \gamma_{i, \text{comb}} + \ln \gamma_{i, \text{res}} \quad (10-66)$$

The first term is the combinatorial part contributes to the Gibbs free energy originating from size and shape effects as

$$\ln \gamma_{i, \text{comb}} = 1 - \phi_i + \ln \phi_i - \frac{z}{2} q_i \left(1 + \frac{\phi_i}{\theta_i} + \ln \left(\frac{\phi_i}{\theta_i} \right) \right) \quad (10-67)$$

and the second term is the residual part from chemical interactions between the molecules,

$$\ln \gamma_{i, \text{res}} = q_i \left(1 - \ln \left(\frac{\sum_j x_j q_j \tau_{j,i}}{\sum_j x_j q_j} \right) - \sum_j \frac{x_j q_j \tau_{j,i}}{\sum_k x_k q_k \tau_{k,j}} \right) \quad (10-68)$$

where

$$\phi_i = \frac{r_i}{\sum_j x_j r_j} \quad (10-69)$$

$$\theta_i = \frac{q_i}{\sum_j x_j q_j} \quad (10-70)$$

$$\tau_{i,j} = \exp\left(\frac{-\Delta E_{i,j}}{T}\right) \quad (10-71)$$

The coordination number is taken equal to $z = 10$. The binary interaction energy parameters, $\Delta E_{i,j}$, are specified in terms of absolute temperature (K). The diagonal values are zero and the matrix is nonsymmetric. All off-diagonal values must be specified.

$$\Delta E_{i,i} = 0 \quad (10-72)$$

$$\tau_{i,i} = 1 \quad (10-73)$$

The volume parameters, r_i , and surface area parameters, q_i , are model-specific parameters for each species. If the parameters are not specified, they can be derived from the van der Waals volume, $V_{\text{VDW},i}$, and area, $A_{\text{VDW},i}$, respectively

$$r_i = \frac{V_{\text{VDW},i}}{0.01517 \cdot 10^{-3}} \quad (10-74)$$

$$q_i = \frac{A_{\text{VDW},i}}{2.5 \cdot 10^{-5}} \quad (10-75)$$

For all species r_i or $V_{VDW,i}$ and q_i or $A_{VDW,i}$ must be specified.

UNIFAC

The UNIQUAC Functional-group Activity Coefficients (UNIFAC; see Ref. 20) uses the same equations as UNIQUAC but the parameters are constructed from group contributions. The model can be used if UNIQUAC parameters are not available for all species. The activity coefficients are calculated from Equation 10-66. The combinatorial part follows from equation Equation 10-67, where

$$r_i = \sum_k v_{k,i} r_k \quad (10-76)$$

$$q_i = \sum_k v_{k,i} q_k \quad (10-77)$$

where r_k and q_k are the values for group k in species i , and $v_{k,i}$ is the number of occurrences of group k in molecule. The residual term in Equation 10-66 is calculated from a summation over functional groups:

$$\ln \gamma_{i, \text{res}} = \sum_k v_{k,i} (\ln \gamma_{k, \text{res}} - \ln \gamma_{i, k, \text{res}}) \quad (10-78)$$

The values for $\ln(\gamma_{k, \text{res}})$ are calculated from the mixture containing all species at a specified composition x . The values for $\ln(\gamma_{i, k, \text{res}})$ are calculated for a mixture of group k considering only pure species i . Both are defined, for functional group k , by

$$\ln \gamma_{k, \text{res}} = q_k \left(1 - \ln \left(\frac{\sum_l x_l q_l \tau_{l,k}}{\sum_l x_l q_l} \right) - \sum_j \frac{x_j q_j \tau_{k,j}}{\sum_m x_m q_m \tau_{m,l}} \right) \quad (10-79)$$

where x_l and x_m are the compositions of functional group l and m in the mixture

$$x_m = \frac{\sum_i x_i v_{m,i}}{\sum_i \left(x_i \sum_k v_{k,i} \right)} \quad (10-80)$$

For the calculation of a pure species' i residual activity we get:

$$x_m = \frac{v_{m,i}}{\sum_k v_{k,i}} \quad (10-81)$$

The volume parameters r_k and surface area parameters q_k are model-specific parameters for each group. The binary interaction between groups k and m is

$$\tau_{k,m} = \exp\left(-\frac{A_{k,m}}{T}\right) \quad (10-82)$$

The binary interaction parameters, $A_{k,m}$, are specified in terms of absolute temperature. The diagonal values are zero, the matrix is nonsymmetric. All off-diagonal values must be specified.

The default group and interaction parameters are those published by the UNIFAC consortium (Ref. 21 through Ref. 26), with added groups from Balslev and Abildskov (Ref. 27) but can be modified per package or database. The groups must be specified for all species. Note that the interaction parameter matrix is sparse, and a package can only be used if all interaction parameters for all used groups are specified.

Chao–Seader (Grayson–Streed)

The Chao–Seader model Ref. 13 correlates liquid phase partial coefficients for pure species, for use of hydrogen and hydrocarbon mixtures at elevated pressure and temperatures. It is expressed by

$$\ln \phi_{i,l} = \ln \gamma_i + \ln \phi_{i,l,0} \quad (10-83)$$

The activity is based on the Scatchard–Hildebrand equation Ref. 14 and presented in Equation 10-45 to Equation 10-47. Chao–Seader specific values for liquid volume, V_i , and solubility parameter, δ_i , are used.

If V_i is unspecified, it can be estimated by

- a molar volume at normal boiling point
- b van der Waals volume
- c from the Rackett model, Equation 10-80, at normal boiling point temperature.

If the Chao–Seader specific solubility parameter, δ_i , is not specified, the generic solubility parameter is used.

The fugacity coefficient for pure species i is correlated as

$$\log \phi_{i,l,0} = \log \phi_{i,l,1} + \omega_i \log \phi_{i,l,2} \quad (10-84)$$

$$\log \phi_{i,l,1} = A_{i,0} + \frac{A_{i,1}}{T_{r,i}} + A_{i,2}T_{r,i} + A_{i,3}T_{r,i}^2 + A_{i,4}T_{r,i}^3 \quad (10-85)$$

$$+ (A_{i,7}T_{r,i}^2 + A_{i,6}T_{r,i} + A_{i,5})P_{r,i} + (A_{i,9}T_{r,i} + A_{i,8})P_{r,i}^2 - \log P_{r,i}$$

$$\log \phi_{i,l,2} = A_{i,10} + \frac{A_{i,12}}{T_{r,i}} + A_{i,11}T_{r,i} + A_{i,13}T_{r,i}^2 + A_{i,14}(P_{r,i} - 0.6) \quad (10-86)$$

A Chao–Seader specific acentric factor ω_i is used. If it is unknown, it can be set equal to the generic acentric factor. The parameter values are taken from the later publication of Grayson and Streed [Ref. 15](#) and given in [Table 10-2](#).

TABLE 10-2: CHAO–SEADER GRAYSON–STREED FUGACITY COEFFICIENT PARAMETERS.

	H ₂	CH ₄	OTHER		ALL
A _{i,0}	1.50709	1.36822	2.05135	A _{i,10}	-4.23893
A _{i,1}	2.74283	-1.54831	-2.10899	A _{i,11}	8.65808
A _{i,2}	-0.02110			A _{i,12}	-1.22060
A _{i,3}	0.00011	0.02889	-0.19396	A _{i,13}	-3.15224
A _{i,4}		-0.01076	0.02282	A _{i,14}	-0.02500
A _{i,5}	0.008585	0.10486	0.08852		
A _{i,6}		-0.02529			
A _{i,7}			-0.00872		
A _{i,8}			-0.00353		
A _{i,9}			0.00203		

The corresponding vapor phase model is Redlich–Kwong equation of state. The Chao–Seader (Grayson–Streed) model is valid when

- 255 K < T < 533 K
- P < 6.89 MPa
- P_r < 0.8
- 0.5 < T_{r,i} < 1.3, for all hydrocarbons except CH₄
- x_{CH4} < 0.3
- For systems that include CH₄ or H₂S:

$$\sum_i x_i T_{r,i} < 0.93$$

The enthalpy, entropy, and Gibbs free energy can be calculated from [Equation 10-109](#) to [Equation 10-118](#).

LIQUID VOLUME MODELS

When an activity coefficient model or the Chao–Seader (Grayson–Streed) model is used, a liquid volume model must be explicitly selected. It is also possible to assign a liquid volume model when an equation of state is used.

For liquids the density is defined as the reciprocal of the liquid volume:

$$\rho_l = \frac{1}{\bar{V}_l} \quad (10-87)$$

Using a cubic equation of state, the solution has 1, 2, or 3 different roots for the volume. The liquid density is defined as the root producing the highest density, and the vapor density as the root producing the lowest density.

Equation of State

When an equation of state is selected as the liquid phase model, the liquid volume is by default set to be calculated using the same equation of state model. The other liquid volume models; [Ideal Mixture](#), [COSTALD](#), and [Rackett](#) are also available.

Note, the vapor phase model and the liquid volume cannot use different equation of state models.

Ideal Mixture

For an ideal mixture the liquid volume is computed from the pure species densities (corresponding to the saturated liquid density):

$$V_{l,m} = \sum_i \frac{x_i}{\rho_{i,l}} \quad (10-88)$$

In this case the pure species densities corresponds to the saturated liquid density, which is available as a temperature dependent correlation for all species in the built-in database.

COSTALD

Hankinson and Thomson [Ref. 28](#) presented the Corresponding States Liquid Density (COSTALD) equation as

$$\frac{V}{\bar{V}_{mix}} = V_{r,ref}(1 - \omega V_{r,\delta}) \quad (10-89)$$

$$V_{r,ref} = 1 + a(1 - T_r)^{1/3} + b(1 - T_r)^{2/3} + c(1 - T_r) + d(1 - T_r)^{4/3} \quad (10-90)$$

$$V_{r,\delta} = \frac{e + fT_r + gT_r^2 + hT_r^3}{T_r - 1.00001} \quad (10-91)$$

$$V_{mix} = \frac{1}{4} \left(\sum_i x_i V_i + 3 \left(\sum_i x_i V_i^{2/3} \right) \left(\sum_i x_i V_i^{1/3} \right) \right) \quad (10-92)$$

$$T_c = \frac{\left(\sum_i x_i \sqrt{T_{c,i} V_i} \right)^2}{V_{mix}} \quad (10-93)$$

$$T_r = \begin{cases} \frac{T}{T_c} & T < T_c \\ 1 & T \geq T_c \end{cases} \quad (10-94)$$

$$\omega = \sum_i x_i \omega_i \quad (10-95)$$

where the volume, V_i , and acentric factor, ω_i for species i are model specific parameters. If the COSTALD volume parameter is unspecified, it is estimated from the van der Waals volume when $V_{VDW,i} > 0.3 \times 10^{-3} \text{ m}^3/\text{mol}$

$$V_i = 5.385 V_{VDW,i} - 5.1022 V_{VDW,i}^2 + 79.524 V_{VDW,i}^3 - 99.316 V_{VDW,i}^4 + 100.88 V_{VDW,i}^5 - 1152.7 V_{VDW,i}^6 \quad (10-96)$$

otherwise, it can be set equal to the critical volume as

$$V_i = V_{c,i} \quad (10-97)$$

If the COSTALD acentric factor, ω_i is not specified, it can be set equal to the generic acentric factor for species i . A critical temperature, $T_{c,i}$ must be specified for all species.

The correlation parameter values are:

TABLE 10-3: REDUCED VOLUME CORRELATION PARAMETERS IN COSTALD.

a	-1.52816	e	-0.296123
b	1.43907	f	0.386914

TABLE 10-3: REDUCED VOLUME CORRELATION PARAMETERS IN COSTALD.

c	-0.81446	g	-0.0427258
d	0.190454	h	-0.0480645

Rackett

The Rackett equation [Ref. 29](#) computes the liquid density at the saturation point, and can be used to describe liquid density at any pressure using the assumption that the liquid is incompressible. The equation and its condition can be expressed as:

$$V_l = \left(R \sum_i \frac{x_i T_{c,i}}{(MW)_i P_{c,i}} \right) \left(\sum_i Z_{r,i} \right)^{(1 + (1 - T_r^2)^{2.7})} \left(\sum_i x_i (MW)_i \right) \quad (10-98)$$

$$T_c = \sum_i x_i T_{c,i} \quad (10-99)$$

$$T_r = \begin{cases} \frac{T}{T_c} & T < T_c \\ 1 & T \geq T_c \end{cases} \quad (10-100)$$

Critical temperatures, $T_{c,i}$, critical pressures, $P_{c,i}$, and molecular weights, M_i , must be specified for all species. The model parameter, $Z_{r,i}$, must be specified for all species. If the value is not available it can be set to the critical compressibility factor:

$$Z_{r,i} = Z_{c,i} \quad (10-101)$$

Selecting the Right Thermodynamic Model

Which thermodynamic model is the most appropriate depends on a number of things, for example the nature of the properties to be used, the operational pressure and temperature, and not least the availability of the required model parameters. One general introduction to how to select thermodynamic models, as well as estimating missing parameters and validating properties can be found in [Ref. 77](#).

Below is a decision tree that can be used as a guide for choosing the thermodynamic model:

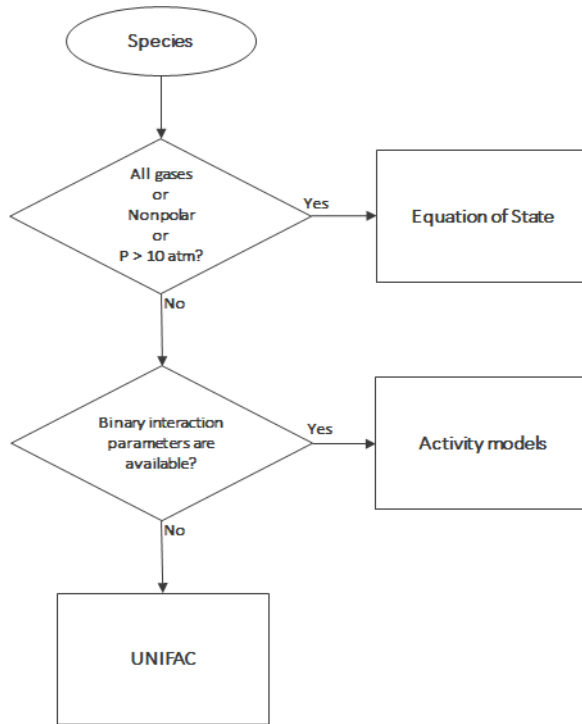

Figure 10-36: Decision tree to select thermodynamics model.

Species Property References

All references used for the included constants and temperature-dependent properties are available in the database file. The reference comments can be inspected in the settings window by right-clicking a species property node (under a **Thermodynamic System**) and selecting **Properties**.

Thermodynamic Properties Definitions

The thermodynamic properties provided are listed as species and mixture property in a Property package.

Ideal Gas

The ideal gas law is independent of composition and determines V at given T and P .

Density can be calculated from

$$\rho = \frac{1}{V} \quad (10-102)$$

The partial fugacity coefficients

$$\ln \hat{\phi}_i = 0 \quad (10-103)$$

The ideal gas enthalpy for mixture

$$H_{ig} = \sum_i x_i \left(H_{i,ig,T_{ref}} + \int_{T_{ref}}^T C_{P,i,ig} dT \right) \quad (10-104)$$

where $H_{i,ig,T_{ref}}$ relates the enthalpy of an ideal gas to the enthalpy at the selected reference state for species i .

The ideal gas entropy for species i

$$S_{ig} = \sum_i x_i \left(S_{i,ig,T_{ref}} - R \ln x_i + \int_{T_{ref}}^T \frac{C_{P,i,ig}}{T} dT \right) - R \ln \left(\frac{P}{P_{ref}} \right) \quad (10-105)$$

where $S_{i,ig,T_{ref}}$ is the entropy of an ideal gas to the entropy of species at the selected reference state.

The Gibbs free energy follows from

$$G_{ig} = H_{ig} - TS_{ig} \quad (10-106)$$

Equation of State

The equation of state determines V at given x , T , and P . Density can be expressed as [Equation 10-102](#). The partial fugacity coefficients are derived from

$$\ln \hat{\phi}_i = \frac{1}{RT} \int_0^P \left(\hat{V}_i - \frac{RT}{P} \right) \quad (10-107)$$

where V_i is the partial molar volume. The enthalpy, entropy, and Gibbs free energy follow from the partial fugacity coefficients and the ideal gas contributions as:

$$H = H_{ig} - RT^2 \sum_i x_i \left(\frac{\partial \ln \hat{\phi}_i}{\partial T} \right) \quad (10-108)$$

$$S = S_{ig} - R \sum_i x_i \left(\ln \hat{\phi}_i + T \frac{\partial \ln \hat{\phi}_i}{\partial T} \right) \quad (10-109)$$

$$G = G_{ig} - RT \sum_i x_i \ln \hat{\phi}_i \quad (10-110)$$

Heat Capacity

The heat capacity at constant pressure is calculated from

$$C_P = \left(\frac{\partial H}{\partial T} \right)_{P,x} \quad (10-111)$$

It is available when the enthalpy is available. The heat capacity at constant volume is defined by

$$C_v = \left(\frac{\partial H}{\partial T} \right)_{v,x} \quad (10-112)$$

The relationship between the heat capacity at constant pressure and constant volume can be expressed as

$$C_p - C_v = T \left(\frac{\partial V}{\partial T} \right)_{P,x} \left(\frac{\partial P}{\partial T} \right)_{v,x} \quad (10-113)$$

where v is a function of T and P . A Taylor expansion of v at constant composition gives

$$\Delta v = \left(\frac{\partial V}{\partial T} \right)_{P,x} \Delta T + \left(\frac{\partial V}{\partial P} \right)_{T,x} \Delta P = 0 \quad (10-114)$$

Rearranging equations above gives

$$C_v = C_p + \frac{T \left(\frac{\partial V}{\partial T} \right)_{P,x}^2}{\left(\frac{\partial V}{\partial P} \right)_{T,x}} \quad (10-115)$$

C_v is available if C_p and volume are available and fluid is compressible by means of volume is pressure dependent. For ideal gas [Equation 10-113](#) express as

$$C_p - C_v = R \quad (10-116)$$

Specific heat capacity ratio is defined as

$$\gamma = \frac{C_p}{C_v} \quad (10-117)$$

Activity Coefficient Models

The enthalpy, entropy, and Gibbs free energy follow from the activity coefficients and the ideal gas contributions in Equation 10-104 – Equation 10-106. The activity coefficients describe the deviation of chemical potentials from the ideal liquid phase, so heats of vaporization need to be accounted for

$$H = \sum_i x_i \left(H_{i,ig, T_{ref}} + \int_{T_{ref}}^T C_{P,i,ig} dT - \Delta H_{i,vap} - RT^2 \frac{\partial \ln \gamma_i}{\partial T} - RT^2 \frac{\partial \ln \hat{\phi}_{i,sat}}{\partial T} \right) \quad (10-118)$$

$$S = \sum_i x_i \left(S_{i,ig, T_{ref}} - R \ln x_i + \int_{T_{ref}}^T \frac{C_{P,i,ig}}{T} dT - R \ln \left(\frac{P_{i,sat}}{P_{ref}} \right) + \ln \gamma_i + T \frac{\partial \ln \gamma_i}{\partial T} + \ln \hat{\phi}_{i,sat} + T \frac{\partial \ln \hat{\phi}_{i,sat}}{\partial T} + R \frac{\Delta H_{i,vap}}{T} \right) \quad (10-119)$$

$$G = \sum_i x_i \left(H_{i,ig, T_{ref}} + \int_{T_{ref}}^T C_{P,i,ig} dT - T \left(S_{i,ig, T_{ref}} + \int_{T_{ref}}^T \frac{C_{P,i,ig}}{T} dT \right) + RT \left(\ln x_i + \ln \gamma_i + \ln \hat{\phi}_{i,sat} + \ln \frac{P_{i,sat}}{P_{ref}} \right) \right) \quad (10-120)$$

Note that if the vapor phase is ideal, then the saturated fugacity, $\hat{\phi}_{i,sat}$, contribution can be ignored.

Other Properties

Partial fugacity is calculated from

$$\hat{f}_i = x_i \hat{\phi}_i P \quad (10-121)$$

Internal energy is calculated from

$$U = H - PV + \sum_i x_i U_{i,ig,ref} \quad (10-122)$$

where $U_{i,ig,ref}$ is the enthalpy of an ideal gas to the species enthalpy at the selected reference state.

Helmholtz energy is calculated from

$$A = U - TS = G - PV \quad (10-123)$$

The K -values for phases p and q are taken from

$$K_{i,p,q} = \frac{\hat{\phi}_{i,q}}{\hat{\phi}_{i,p}} \quad (10-124)$$

If only liquid phases are defined, the K -value calculation is reduced to

$$K_{i,p,q} = \frac{\gamma_{i,q}}{\gamma_{i,p}} \quad (10-125)$$

$$M_{\text{mix}} = \sum_i x_i M_i \quad (10-126)$$

Standard Enthalpy of Formation and Absolute Entropy Terms

Formation terms are not included in the enthalpy, entropy, or internal energy. If the enthalpy of formation is specified for all species, EnthalpyF (H_F) represent the enthalpy including the formation terms. If the absolute entropy of all species are specified then the EntropyF (S_F) includes the absolute entropy.

At reference conditions, the heat of any reaction relates to the heat of formation as

$$\Delta H_{\text{reac,ref}} = \sum_i \nu_i (\Delta H_{f,ref}) \quad (10-127)$$

Note that for reacting flow or a heat balance in a reactor when the heat of reaction is explicitly taken into account, the enthalpy should not include the heat of formation.

The following enthalpy expression should be used:

$$H_F = H + \sum_i x_i \Delta H_{f,i,ref} \quad (10-128)$$

$H_{f,i,\text{ref}}$ is calculated such that it matches the reference state of the package, even if the species have a different reference state. Similarly, the absolute entropy of each species is taken into account according to

$$S_F = S + \sum_i x_i S_{\text{abs},i} \quad (10-129)$$

The entropy balance over a process that includes reactions should include either the entropy of reaction and use S , or use S_F without entropy of reaction.

In database, a set of parameters introduced to define Absolute entropy and Standard enthalpy of formation for ideal gas and different phases (Vapor, liquid, Solid, and Aqueous infinite dilution). One can use these parameters to calculate Gibbs free energy of reaction when different phases are available (See Electrode reaction).

SPECIES GIBBS FREE ENERGY OF FORMATION

As the COMSOL ThermoDB does not include entropy of formation of species, entropy Equation 10-129 and in consequence Gibbs free energy Equation 10-110 are estimated from absolute entropy's value. Therefore, the absolute value of entropy of formation and Gibbs free energy of formation of the species are not correct. However, for our applications these absolute values are not required while the value of entropy and Gibbs free energy change of reaction (the difference value) are correct.

If user needs the absolute value of entropy of formation, it is possible to estimate it by:

$$S_i = \Delta S_{f,i} = \sum_j \nu_j S_{\text{abs}j} \quad (10-130)$$

where the entropy of formation of species i is calculated from its elemental constituent j . For example, entropy of formation of ammonia at 298 K is



$$\Delta S_{f,NH_3} = 2S_{\text{abs},NH_3} - (S_{\text{abs},N_2} + 3S_{\text{abs},H_2}) \quad (10-132)$$

The values from RHS of Equation 10-132 can be extracted from COMSOLThermoDB. This value should be used in Equation 10-128 to estimate the absolute value of Gibbs free energy of species.

Reference State

The reference temperature, pressure, and phase can be specified for each package and for species within a package. The reference phase can be a real phase or an ideal gas. If a reference temperature, pressure, or phase is unspecified for a particular species, the package reference temperature, pressure, or phase is used for that species.

The reference values for enthalpy, $H_{i,\text{ref}}$, entropy, $S_{i,\text{ref}}$, and internal energy, $U_{i,\text{ref}}$, are calculated so that the pure species enthalpy, entropy, and internal energy are equal to zero at reference conditions.

The reference values for enthalpy, including formation terms, and entropy, including absolute terms, are calculated such that the corresponding property for pure species i has a value equal to the specified formation term at the species reference conditions.

Transport Properties

This section includes definitions of the models available in for thermal conductivity, viscosity, and diffusivity:

- [Thermal Conductivity](#)
- [Viscosity](#)
- [Diffusivity](#)

THERMAL CONDUCTIVITY

Vapor

Ideal

The thermal conductivity correlations is according to:

$$\lambda_v = \sum_i x_i \lambda_{i,v} + \Delta\lambda_{v,P} \quad (10-133)$$

The pressure correction $\Delta\lambda_{v,P}$ is calculated from the method of Stiel and Thodos, see [Ref. 30](#), which is applicable for $\rho_r < 3$, but is less accurate for H_2 , strongly polar gases, and gases with a high degree of hydrogen bonding, such as H_2O and NH_3

$$\Delta\lambda_{v,P} = \frac{P_c^{2/3}}{\sqrt{MT_c^{1/6} Z_c^5}} A(\exp((B\rho_r) + C)) \quad (10-134)$$

$$\rho_r = \frac{\rho}{\rho_c} \quad (10-135)$$

$$\rho_c = \frac{1}{V_c} \quad (10-136)$$

The mixing rules are as suggested by Yorzane, see [Ref. 31](#):

$$V_c = \sum_i x_i \sum_j x_j V_{c,i,j} \quad (10-137)$$

$$T_c = \frac{\sum_i x_i \sum_j x_j V_{c,i,j} T_{c,i,j}}{V_c} \quad (10-138)$$

$$\omega = \sum_i x_i \omega_i \quad (10-139)$$

$$Z_c = 0.291 - 0.08\omega \quad (10-140)$$

$$P_c = \frac{RT_c Z_c}{V_c} \quad (10-141)$$

$$M = \sum_i x_i M_i \quad (10-142)$$

where the binary constants are

$$V_{c,i,j} = \frac{1}{8} (V_{c,i}^{1/3} + V_{c,j}^{1/3})^3 \quad (10-143)$$

$$T_{c,i,j} = \sqrt{T_{c,i} T_{c,j}} \quad (10-144)$$

The Stiel and Thodos coefficients are

TABLE 10-4: PRESSURE CORRECTION PARAMETERS.

	A	B	C
$\rho_r < 0.5$	$A_1 = 2.702E8$	$B_1 = 0.535$	$C_1 = -1$
$0.5 \leq \rho_r < 2.0$	$A_2 = 2.528E8$	$B_2 = 0.670$	$C_2 = -1.069$
$\rho_r \geq 2.0$	$A_3 = 0.574E8$	$B_3 = 1.155$	$C_3 = 2.016$

However, in order to ensure 0th-order continuity at $\rho_r = 0.5$ and $\rho_r = 2.0$, the following coefficients for $0.5 \leq \rho_r < 2.0$ are recalculated from

$$A_2 = \frac{A_1 C_1 + A_1 \exp(0.5 B_1) - A_3 C_3 - A_3 \exp(2.0 B_3)}{\exp(2.0 B_2) - \exp(0.5 B_1)} \quad (10-145)$$

$$C_2 = -\frac{A_1 C_1 \exp(2.0 B_2) + A_1 \exp(0.5 B_1) \exp(2.0 B_2)}{A_1 C_1 + A_1 \exp(0.5 B_1) - A_3 C_3 - A_3 \exp(2.0 B_3)} - \frac{A_3 C_3 \exp(2.0 B_2) + A_3 \exp(0.5 B_2) \exp(2.0 B_3)}{A_1 C_1 + A_1 \exp(0.5 B_1) - A_3 C_3 - A_3 \exp(2.0 B_3)} \quad (10-146)$$

The vapor thermal conductivity correlation must be available for all species. Also critical volumes, $V_{c,i}$, critical temperatures, $T_{c,i}$, molecular weights M_i , and acentric factors ω_i must be specified for all species.

Kinetic Theory

Lindsay and Bromley (see Ref. 32) provided an equation for the interaction parameters of the method of Wassiljewa (see Ref. 33) based on the kinetic theory, to provide mixture thermal conductivity from pure species values

$$\lambda_v = \sum_i \left(\frac{x_i \lambda_{i,v}}{\sum_j x_j \phi_{i,j}} \right) + \Delta \lambda_{v,P} \quad (10-147)$$

$$\phi_{i,j} = \frac{1}{4} \left(1 + \sqrt{\frac{\eta_{i,v} (M_j)^{3/4}}{\eta_{j,v} (M_i)^{3/4}} \left(\frac{T + \left(\frac{3}{2}\right) T_{b,i}}{T + \left(\frac{3}{2}\right) T_{b,j}} \right)^2} \right) \left(\frac{T + \sqrt{\left(\frac{9}{4}\right) T_{b,i} T_{b,j}}}{T + \left(\frac{3}{2}\right) T_{b,i}} \right) \quad (10-148)$$

where the pressure correction $\Delta \lambda_{v,P}$ is calculated from Equation 10-134. Both vapor thermal conductivity correlation $\lambda_{i,v}$ and the vapor viscosity correlation $\eta_{i,v}$ must be available for all species. In addition, all normal boiling points $T_{b,i}$, molecular weights M_i , critical volumes $V_{c,i}$, critical temperatures $T_{c,i}$, and acentric factors ω_i must be specified.

Water (IAPWS)

The International Association of the Properties of Water and Steam recommend an equation Ref. 34 which is valid in the following range:

$$273.15 \text{ K} \leq T \leq 773.15 \text{ K} \quad p \leq 100 \text{ MPa} \quad (10-149)$$

$$773.15 \text{ K} \leq T \leq 923.15 \text{ K} \quad p \leq 70 \text{ MPa} \quad (10-150)$$

$$923.15 \text{ K} \leq T \leq 1073.15 \text{ K} \quad p \leq 40 \text{ MPa} \quad (10-151)$$

Liquid

The following mixture models are available for liquid thermal conductivity

Ideal

To calculate the mixture liquid thermal conductivity, $\lambda_{l,m}$, the values of pure liquid thermal conductivity correlations are mixed ideally

$$\lambda_{l,m} = \sum_i x_i \lambda_{i,l} \quad (10-152)$$

The pressure dependence is based on the work of Missenard ([Ref. 51](#)) where

$$\frac{\lambda_{l,m,P}}{\lambda_{l,m}} = 1 + Q P_r^{0.7} \quad (10-153)$$

where Q is correlated as

$$Q = -0.013693477 + 0.057427673 T_r + 0.001617831 (T_r) (\ln P_1) \quad (10-154)$$

and the following mixing rules are used

$$T_r = \frac{T}{T_c} \quad (10-155)$$

$$P_r = \frac{P}{P_c} \quad (10-156)$$

$$P_c = \frac{RT_c Z_c}{V_c} \quad (10-157)$$

$$V_c = \sum_i x_i V_{c,i} \quad (10-158)$$

$$T_c = \sum_i x_i T_{c,i} \quad (10-159)$$

$$Z_c = \sum_i x_i Z_{c,i} \quad (10-160)$$

All liquid thermal conductivity correlations must be specified. All values for critical temperatures, $T_{c,i}$, critical volumes, $P_{c,i}$ and critical compressibility factors, $Z_{c,i}$ must be specified for all species i .

Power Law

The values of pure liquid vapor thermal conductivity correlations are mixed according to the following power law

$$\frac{1}{\lambda_{l,m}^2} = \sum_i \frac{x_i}{\lambda_{l,i}} \quad (10-161)$$

All liquid thermal conductivity correlations must be specified. The model is valid for pure compound thermal conductivity values that are no more apart than a factor of 2 (Ref. 52 and Ref. 53). The pressure dependence is introduced using Equation 10-153 through Equation 10-160. All values for critical temperatures, $T_{c,i}$, critical volumes, $P_{c,i}$ and critical compressibility factors, $Z_{c,i}$ must be specified for all species i .

Local Composition

The local composition model by Rowley (Ref. 53) uses an ideal and excess contribution

$$\lambda_{l,m} = \lambda_{l, \text{ideal}} + \lambda_{l, \text{excess}} \quad (10-162)$$

The ideal part is based on mass fractions

$$\lambda_{l, \text{ideal}} = \sum_i \omega_i \lambda_{i,l} \quad (10-163)$$

$$\omega_i = \frac{x_i M_i}{\sum_j x_j M_j} \quad (10-164)$$

The excess term is based on NRTL local concentrations

$$\lambda_{l, \text{excess}} = \frac{\sum_i \sum_j \omega_i \omega_j G_{j,i} (\lambda_{j,i} - \lambda_{i,l})}{\sum_j \omega_j G_{j,i}} \quad (10-165)$$

where $G_{j,i}$ follows from Equation 10-58. The binary interaction terms follow from

$$\lambda_{i,j} = \lambda_{j,i} = \frac{\bar{\omega}_i \bar{\omega}_{i,i} \lambda_{i,l} + \bar{\omega}_j \bar{\omega}_{j,j} \lambda_{j,l}}{\bar{\omega}_i \bar{\omega}_{i,i} + \bar{\omega}_j \bar{\omega}_{j,j}} \quad (10-166)$$

which is symmetric, and on the diagonal,

$$\lambda_{i,i} = \lambda_{i,l} \quad (10-167)$$

and

$$\bar{\omega}_{i,i} = \bar{\omega}_i (\bar{\omega}_i + \bar{\omega}_j G_{j,i}) \quad (10-168)$$

with $\bar{\omega}_i$ is the composition in the binary mixture of species i and j and the local composition is equi-molar

$$\bar{\omega}_i = \frac{M_i \sqrt{G_{j,i}}}{M_i \sqrt{G_{j,i}} + M_j \sqrt{G_{i,j}}} \quad (10-169)$$

All liquid thermal conductivity correlations must be specified. The pressure dependence is introduced using Equation 10-153 – Equation 10-160. All values for critical temperatures $T_{c,i}$, critical volumes $P_{c,i}$, critical compressibility factors $Z_{c,i}$, and molecular weights M_i must be specified for all compounds i . In addition, all NRTL binary interaction parameters $A_{i,j}$ must be specified. Unspecified values for NRTL interaction parameters $B_{i,j}$ are set to zero. The randomness parameters $\alpha_{i,j}$ have values of zero on the diagonal and the matrix is symmetric. All off-diagonal values must be specified. NRTL model is presented in Equation 10-54 to Equation 10-65.

Local Composition (Modified)

Rowley (Ref. 52) adapted the local composition model by replacing the mixing rule in Equation 10-166 by the following

$$\lambda_{i,j} = \lambda_{j,i} = \frac{M_i (\bar{\omega}_i \bar{\omega}_{i,i}) \lambda_{i,l} + M_j (\bar{\omega}_j \bar{\omega}_{j,j}) \lambda_{j,l}}{M_i (\bar{\omega}_i \bar{\omega}_{i,i}) + M_j (\bar{\omega}_j \bar{\omega}_{j,j})} \quad (10-170)$$

which he found to produce better model predictions in most cases where both the Local Composition model and Power Law model have trouble. However, the model is not as generally applicable; for instance, systems containing H₂O are not well described by this model due to the low molecular weight of H₂O.

Water (IAPWS)

The International Association of the Properties of Water and Steam recommend an equation [Ref. 34](#) which is valid in the following range:

$$273.15 \text{ K} \leq T \leq 773.15 \text{ K} \quad p \leq 100 \text{ MPa} \quad (10-171)$$

$$773.15 \text{ K} \leq T \leq 923.15 \text{ K} \quad p \leq 70 \text{ MPa} \quad (10-172)$$

$$923.15 \text{ K} \leq T \leq 1073.15 \text{ K} \quad p \leq 40 \text{ MPa} \quad (10-173)$$

VISCOSITY

Vapor

Wilke

Wilke, see [Ref. 35](#), based his method for mixture viscosity of the vapor phase on kinetic theory:

$$\eta_v = \sum_i \left(\frac{x_i \eta_{i,v}}{\sum_j x_j \psi_{i,j}} \right) \quad (10-174)$$

$$\psi_{i,j} = \frac{\left(1 + \sqrt{\frac{\eta_{i,v}}{\eta_{j,v}}} \left(\frac{M_j}{M_i} \right)^{1/4} \right)^2}{\sqrt{8 \left(1 + \frac{M_i}{M_j} \right)}} \quad (10-175)$$

The vapor viscosity correlation $\eta_{i,v}$ must be available for all species. In addition, all molecular weights M_i must be specified.

Brokaw

Brokaw (see [Ref. 36](#)) uses the same basic equation as Wilke ([Equation 10-174](#)). However, [Equation 10-175](#) is replaced by

$$\Psi_{i,j} = S_{i,j} A_{i,j} \sqrt{\frac{\eta_{i,v}}{\eta_{j,v}}} \quad (10-176)$$

and the interaction parameter is defined as

$$A_{i,j} = \frac{\beta_{i,j}}{\sqrt{RM_{i,j}}} \left(1 + \frac{RM_{i,j} - RM_{i,j}^{0.45}}{2(1 + RM_{i,j}) + \frac{1 + RM_{i,j}^{0.45}}{(\sqrt{\beta_{i,j}})(1 + RM_{i,j})}} \right) \quad (10-177)$$

where

$$\beta_{i,j} = \left(\frac{4M_i M_j}{(M_i + M_j)^2} \right)^{1/4}, \quad RM_{i,j} = \frac{M_i}{M_j} \quad (10-178)$$

The vapor viscosity correlation, $\eta_{i,v}$ must be available for all species i . In addition, all molecular weights M_i must be specified. If Lennard–Jones energy ε_i (see Ref. 37) Stockmayer’s polar parameter $\delta_{s,i}$ (Ref. 38 and Ref. 39) are specified for both species i and j then

$$S_{i,j} = \frac{1 + \sqrt{\frac{T^2}{\varepsilon_i \varepsilon_j}} + \frac{1}{4} \delta_{s,i} \delta_{s,j}}{\sqrt{1 + \frac{T}{\varepsilon_i} + \frac{1}{4} \delta_{s,i}} \sqrt{1 + \frac{T}{\varepsilon_j} + \frac{1}{4} \delta_{s,j}}} \quad (10-179)$$

Otherwise,

$$S_{i,j} = 1 \quad (10-180)$$

Davidson

The Davidson method, see Ref. 40, requires fewer compound specific parameters than Brokaw, while reported accuracy is almost as good, and in the case of H_2 , even surpasses it. The Davidson model only requires molar masses and the viscosities of the pure gases. The model is based on fluidity, which is defined to be the reciprocal viscosity.

$$f = \frac{1}{\eta} \quad (10-181)$$

The fluidity of the mixture is then calculated as

$$f = \sum_{i,j} \left(\frac{y_i y_j}{\sqrt{\mu_i} \sqrt{\mu_j}} \cdot E_{i,j}^A \right) \quad (10-182)$$

where y_i is the momentum fraction of species i ; $E_{i,j}$ is the momentum transfer coefficient of the species pair i,j ; and A is an empirical species-independent parameter set to 1/3. The momentum fraction is given by

$$y_i = \frac{x_i \sqrt{M_i}}{\sum_j (x_j \sqrt{M_j})} \quad (10-183)$$

and the momentum transfer coefficient is taken as

$$E_{i,j} = \frac{2 \sqrt{M_i} \sqrt{M_j}}{M_i + M_j} \quad (10-184)$$

High Pressure Modification

To account for the effect of pressure on vapor viscosity, a pressure correction can be applied. The pressure dependence is based on kinetic gas theory, which adds the following term to the vapor viscosity:

$$\Delta \eta_{v,P} = \left(\frac{\sqrt{M} P_c^{2/3}}{T^{1/6}} \right) \left(\frac{10^{-7}}{101325^{2/3}} \zeta \right) \quad (10-185)$$

where ζ is calculated from the correlation of Jossi (Ref. 41), which is applicable for $\rho_r < 3.0$. It is less accurate for H_2 , strongly polar gases and gases with a high degree of hydrogen bonding such as H_2O and NH_3 .

The correction factor is due to using pressure, atm, and viscosity, cP, units in Jossi's correlation. It is expressed as:

$$\begin{aligned} (\xi + 1)^{\frac{1}{4}} &= 1.0230 + 0.23364 \rho_r + 0.58533 \rho_r^2 \\ &- 0.40758 \rho_r^3 + 0.093324 \rho_r^4 \end{aligned} \quad (10-186)$$

$$\rho_r = \frac{\rho}{\rho_c} \quad (10-187)$$

$$\rho_c = \frac{1}{V_c} \quad (10-188)$$

The following mixture rules are used

$$P_c = \frac{RT_c Z_c}{V_c}, V_c = \sum_i x_i V_{c,i}, T_c = \sum_i x_i T_{c,i} \quad (10-189)$$

$$Z_c = \sum_i x_i Z_{c,i}, M_t = \sum_i x_i M_i \quad (10-190)$$

The values for critical volumes, $V_{c,i}$, critical temperatures, $T_{c,i}$, critical compressibility factors, $Z_{c,i}$ and molecular weights, M_i must be specified for all species i .

The high pressure correction is available for the Wilke, Brokaw, and Davidson mixture models. The vapor viscosity follows from

$$\eta_v = \eta_{v, \text{Wilke}} + \Delta\eta_{v,P} \quad (10-191)$$

where $\eta_{v, \text{Wilke}}$ is calculated from [Equation 10-174](#).

Pedersen Corresponding States Model

The corresponding states viscosity model of Pedersen ([Ref. 42](#) and [Ref. 43](#)) applies to both vapor and liquid phases of hydrocarbon mixtures. The selected reference species is CH_4 .

The CH_4 viscosity is calculated from [Ref. 44](#), modified by Pedersen and Fredenslund ([Ref. 45](#)) to avoid issues below 91 K where CH_4 becomes solid

$$\eta_{\text{CH}_4} = \eta_{\text{CH}_4,0} + \rho_{\text{CH}_4} \eta_{\text{CH}_4,1} + F_1 \eta_{\text{CH}_4,2} + F_2 \eta_{\text{CH}_4,3} \quad (10-192)$$

where

$$F_1 = \frac{H+1}{2} \quad (10-193)$$

$$F_2 = \frac{1-H}{2} \quad (10-194)$$

$$H = \frac{\exp(\Delta T) - \exp(-\Delta T)}{\exp(\Delta T) + \exp(-\Delta T)} \quad (10-195)$$

$$\Delta T = T - 91 \text{ K} \quad (T \in \text{K}) \quad (10-196)$$

Here, ρ_{CH_4} is used in g/cm^3 ; for the mass-mole conversion of ρ_{CH_4} , a molecular weight of $M_{\text{CH}_4} = 16.042568 \text{ g/mol}$ is used.

The dilute gas part is given by

$$\eta_{\text{CH}_4,0} = \frac{-L_1}{T} + \frac{L_2}{T^{2/3}} - \frac{L_3}{T^{1/3}} + L_4 - L_5 T^{1/3} + L_6 T^{2/3} - L_7 T + L_8 T^{4/3} - L_9 T^{5/3} \quad (10-197)$$

The first density correction for the moderately dense gas is given by

$$\eta_{\text{CH}_4,1} = L_{10} - L_{11} \left(1.4 - \ln \frac{T}{168 \text{ K}} \right)^2 \quad (10-198)$$

The remainder is given by the empirical correlation

$$\eta_{\text{CH}_4,2} = \exp\left(\frac{L_{12}}{T} - L_{13}\right) \left(\exp\left((10\sqrt{\rho_{\text{CH}_4}}) \left(L_{14} - \frac{L_{15}}{T^{3/2}} \right) + \left(\frac{\rho_{\text{CH}_4} - \rho_{c,\text{CH}_4}}{\rho_{c,\text{CH}_4}} \right) (\sqrt{\rho_{\text{CH}_4}}) \left(L_{16} + \frac{L_{17}}{T} + \frac{L_{18}}{T^2} \right) \right) - 1 \right) \quad (10-199)$$

The correction term for solid CH_4

$$\eta_{\text{CH}_4,3} = \exp\left(\frac{L_{19}}{T} - L_{20}\right) \left(\exp\left((10\sqrt{\rho_{\text{CH}_4}}) \left(L_{21} - \frac{L_{22}}{T^{3/2}} \right) + \left(\frac{\rho_{\text{CH}_4} - \rho_{c,\text{CH}_4}}{\rho_{c,\text{CH}_4}} \right) (\sqrt{\rho_{\text{CH}_4}}) \left(L_{23} + \frac{L_{24}}{T} + \frac{L_{25}}{T^2} \right) \right) - 1 \right) \quad (10-200)$$

with the values of the parameters L_1 through L_{25} are listed in [Table 10-5](#) below:

TABLE 10-5: METHANE VISCOSITY NUMERICAL COEFFICIENTS.

L_1	$2.090975 \cdot 10^5$	L_{10}	1.696985927	L_{19}	9.74602
L_2	$2.647269 \cdot 10^5$	L_{11}	0.133372346	L_{20}	44.6055
L_3	$1.472818 \cdot 10^5$	L_{12}	188.73011594	L_{21}	18.0834
L_4	47167.40	L_{13}	10.35060586	L_{22}	4126.66
L_5	9491.827	L_{14}	17.571599671	L_{23}	0.976544
L_6	1219.979	L_{15}	3019.3918656	L_{24}	81.8134
L_7	96.27993	L_{16}	0.042903609488	L_{25}	15649.9

TABLE 10-5: METHANE VISCOSITY NUMERICAL COEFFICIENTS.

L_8	4.274152	L_{17}	145.29023444		
L_9	0.08141531	L_{18}	6127.6818706		

Here, ρ_{CH_4} is used in g/cm^3 ; the critical density is given by $\rho_{c,\text{CH}_4} = 0.16284 \text{ g}/\text{cm}^3$. The following equation by McCarty (Ref. 46) is solved for the density of CH_4

$$\begin{aligned}
P = & N_1 \rho_{\text{CH}_4} T + \rho_{\text{CH}_4}^2 \left(-N_2 T + N_3 \sqrt{T} - N_4 + \frac{N_5}{T} - \frac{N_6}{T^2} \right) \quad (10-201) \\
& + \rho_{\text{CH}_4}^3 \left(N_7 T - N_8 + \frac{N_9}{T} - \frac{N_{10}}{T^2} \right) + \rho_{\text{CH}_4}^4 \left(-N_{11} T + N_{12} + \frac{-N_{13}}{T} \right) + N_{14} \rho_{\text{CH}_4}^5 \\
& + \rho_{\text{CH}_4}^6 \left(-\frac{N_{15}}{T} + \frac{N_{16}}{T^2} \right) + N_{17} \frac{\rho_{\text{CH}_4}^7}{T} + \rho_{\text{CH}_4}^8 \left(\frac{N_{18}}{T} + \frac{N_{19}}{T^2} \right) + N_{20} \frac{\rho_{\text{CH}_4}^9}{T} \\
& + \exp(-N_{21} \rho_{\text{CH}_4}^2) \left(\rho_{\text{CH}_4}^3 \left(\frac{N_{22}}{T^2} - \frac{N_{23}}{T^3} \right) + \rho_{\text{CH}_4}^5 \left(\frac{N_{24}}{T^2} + \frac{N_{25}}{T^4} \right) + \rho_{\text{CH}_4}^7 \left(\frac{N_{26}}{T^2} + \frac{N_{27}}{T^3} \right) \right. \\
& \left. + \rho_{\text{CH}_4}^9 \left(-\frac{N_{28}}{T^2} - \frac{N_{29}}{T^4} \right) + \rho_{\text{CH}_4}^{11} \left(-\frac{N_{30}}{T^2} + \frac{N_{31}}{T^3} \right) + \rho_{\text{CH}_4}^{13} \left(\frac{N_{32}}{T^2} - \frac{N_{33}}{T^3} + N_{34} T^4 \right) \right)
\end{aligned}$$

where ρ_{CH_4} is used in mol/l.

TABLE 10-6: COEFFICIENTS IN THE FUNCTIONAL FORM OF THE MCCARTY EOS.

N_1	0.08205616	N_{13}	2.8685285973	N_{25}	$1.6428375992 \cdot 10^6$
N_2	0.018439486666	N_{14}	$0.11906973942 \cdot 10^{-3}$	N_{26}	0.21325387196
N_3	1.0510162064	N_{15}	0.0085315715699	N_{27}	37.791273422
N_4	16.057820303	N_{16}	3.8365063841	N_{28}	$0.1185701681 \cdot 10^{-4}$
N_5	848.44027562	N_{17}	$0.24986828379 \cdot 10^{-4}$	N_{29}	31.630780767
N_6	42738.409106	N_{18}	$0.57974531455 \cdot 10^{-5}$	N_{30}	$0.4100678294 \cdot 10^{-5}$
N_7	$0.76565285254 \cdot 10^{-3}$	N_{19}	0.0071648329297	N_{31}	0.0014870043284
N_8	0.48360724197	N_{20}	$0.12577853784 \cdot 10^{-3}$	N_{32}	$3.151226153 \cdot 10^{-9}$
N_9	85.195473835	N_{21}	0.0096	N_{33}	$0.2167077474 \cdot 10^{-5}$
N_{10}	16607.434721	N_{22}	22240.102466	N_{34}	$0.2400055107 \cdot 10^{-4}$
N_{11}	$0.37521074532 \cdot 10^{-4}$	N_{23}	$1.4800512328 \cdot 10^6$		
N_{12}	0.028616309259	N_{24}	50.498054887		

With the viscosity and density of CH_4 defined, the viscosity of any mixture, η_m , can be calculated from the corresponding states principle

$$\eta_m = \left(\frac{T_c}{T_{c, \text{CH}_4}}\right)^{-\frac{1}{6}} \left(\frac{P_c}{P_{c, \text{CH}_4}}\right)^{2/3} \left(\frac{M_m}{M_{\text{CH}_4}}\right)^{1/2} \left(\frac{\alpha}{\alpha_{\text{CH}_4}}\right) \eta_{\text{CH}_4, P_0, T_0} \quad (10-202)$$

where the CH_4 viscosity $\rho_{\text{CH}_4, P_0, T_0}$ is calculated at temperature T_0 and pressure P_0 :

$$T_0 = \left(\frac{T_{c, \text{CH}_4}}{T_c}\right) T \left(\frac{\alpha_{\text{CH}_4}}{\alpha}\right) \quad (10-203)$$

$$P_0 = \left(\frac{P_{c, \text{CH}_4}}{P_c}\right) P \left(\frac{\alpha_{\text{CH}_4}}{\alpha}\right) \quad (10-204)$$

The following mixing rules are used for the critical properties, see [Ref. 47](#):

$$T_c = \frac{\sum_i \sum_j x_i x_j \beta_{i,j} \sqrt{T_{c,i} T_{c,j}}}{\sum_i \sum_j x_i x_j \beta_{i,j}} \quad (10-205)$$

$$P_c = \frac{8 \sum_i \sum_j x_i x_j \beta_{i,j} \sqrt{T_{c,i} T_{c,j}}}{\left(\sum_i \sum_j x_i x_j \beta_{i,j}\right)^2} \quad (10-206)$$

$$\beta_{i,j} = \left(\left(\frac{T_{c,i}}{P_{c,i}}\right)^{1/3} + \left(\frac{T_{c,j}}{P_{c,j}}\right)^{1/3} \right)^3 \quad (10-207)$$

The parameter α is

$$\alpha = 1 + 7.378 \times 10^{-3} \rho_r^{1.847} M_m^{0.5173} \quad (10-208)$$

$$\rho_r = \frac{\rho_{\text{CH}_4, P_0, T_0}}{\rho_{c, \text{CH}_4}} \quad (10-209)$$

where

$$T_0 = \left(\frac{T_{c, \text{CH}_4}}{T_c}\right) T \quad (10-210)$$

$$P_0 = \left(\frac{P_{c, \text{CH}_4}}{P_c} \right) P \quad (10-211)$$

with $\rho_{c, \text{CH}_4} = 0.16284 \text{ g/cm}^3$. For CH_4

$$\alpha_{\text{CH}_4} = 1 + 7.378 \times 10^{-3} \rho_r^{1.847} M_{\text{CH}_4}^{0.5173} \quad (10-212)$$

where Equation 10-209 is used. The mixture molecular weight is a function of the weight-averaged molecular weight and the number-averaged molecular weight

$$M_m = 1.304 \times 10^{-4} (M_W^{2.303} - M_N^{2.303}) + M_N \quad (10-213)$$

$$M_W = \frac{\sum_i x_i M_i^2}{M_N} \quad (10-214)$$

$$M_N = \sum_i x_i M_i \quad (10-215)$$

where the power in Equation 10-213 is determined by fitting to experimental viscosity data.

Note that pure species vapor viscosity correlations $\eta_{i,v}$ are not required. However, for each species i , molecular weight M_i , critical temperature, $T_{c,i}$, and critical pressure, $P_{c,i}$ must be specified.

Water (IAPWS)

The International Association of the Properties of Water and Steam recommend an equation Ref. 48–Ref. 49 for industrial application which is valid in the following range:

$$273.16 \text{ K} \leq T \leq 1173.15 \text{ K} \quad 0 \leq p \leq p_t \quad (10-216)$$

$$T_m(p) \leq T \leq 1173.15 \text{ K} \quad p_t \leq p \leq 300 \text{ MPa} \quad (10-217)$$

$$T_m(p) \leq T \leq 873.15 \text{ K} \quad 300 \text{ MPa} \leq p \leq 350 \text{ MPa} \quad (10-218)$$

$$T_m(p) \leq T \leq 433.15 \text{ K} \quad 350 \text{ MPa} \leq p \leq 500 \text{ MPa} \quad (10-219)$$

$$T_m(p) \leq T \leq 373.15 \text{ K} \quad 500 \text{ MPa} \leq p \leq 1000 \text{ MPa} \quad (10-220)$$

where T_m is the pressure dependent melting temperature and p_t is the triple-point pressure. In accordance with industrial application recommendations, critical region correction is not applied.

Liquid

The following mixture models are available for liquid viscosity.

Molar Logarithmic Mixing

The values of pure species log liquid viscosity, $\ln \eta_{i,l}$ are mixed ideally using mole fractions x_i

$$\ln \eta_{l,m} = \sum_i x_i \ln \eta_{i,l} \quad (10-221)$$

where $\eta_{m,l}$ is the mixture viscosity of liquids.

Mass Logarithmic Mixing

The values of pure species log liquid viscosity correlation are mixed ideally using the weight fractions ω_i

$$\ln \eta_{l,m} = \sum_i \omega_i \ln \eta_{i,l} \quad (10-222)$$

Pedersen Corresponding States Model

The [Pedersen Corresponding States Model](#) described above for the gas phase viscosity also applies to the liquid phase. Pure species liquid viscosity correlations are not required. However, for each species i , molecular weight M_i , critical temperature $T_{c,i}$, and critical pressure $P_{c,i}$, must be specified.

Cubic mixing

The mixture viscosity is defined using the cubic root average in terms of the mole fractions x_i

$$\eta_{l,m} = \left(\sum_i x_i \eta_{i,l}^{1/3} \right)^3 \quad (10-223)$$

The model is noted in [Ref. 50](#) to provide reasonable results for hydrocarbon mixtures of similar components.

The model requires that the log liquid viscosity correlation is available for all species i .

Cubic mass mixing

The mass fraction equivalent of the previous model is

$$\eta_{l,m} = \left(\sum_i \omega_i \eta_{i,l}^{1/3} \right)^3 \quad (10-224)$$

The model requires that the log liquid viscosity correlation is available for all species i .

Water (IAPWS)

The International Association of the Properties of Water and Steam recommend an equation [Ref. 48–Ref. 49](#) for industrial application which is valid in the following range:

$$273.16\text{K} \leq T \leq 1173.15\text{K} \quad 0 \leq p \leq p_t \quad (10-225)$$

$$T_m(p) \leq T \leq 1173.15 \text{ K} \quad p_t \leq p \leq 300 \text{ MPa} \quad (10-226)$$

$$T_m(p) \leq T \leq 873.15 \text{ K} \quad 300 \text{ MPa} \leq p \leq 350 \text{ MPa} \quad (10-227)$$

$$T_m(p) \leq T \leq 433.15 \text{ K} \quad 350 \text{ MPa} \leq p \leq 500 \text{ MPa} \quad (10-228)$$

$$T_m(p) \leq T \leq 373.15 \text{ K} \quad 500 \text{ MPa} \leq p \leq 1000 \text{ MPa} \quad (10-229)$$

where T_m is the pressure dependent melting temperature and p_t is the triple-point pressure. In accordance with industrial application recommendations, critical region correction is not applied.

DIFFUSIVITY

Two types of diffusion coefficients are supported. Diffusion coefficients in infinitely diluted systems, and Maxwell–Stefan diffusion coefficients.

For dilute systems, the binary diffusion coefficient $D_{i,j}^0$ represent the diffusivity of species i in a medium consisting of pure species j . This corresponds to the Fickian diffusion coefficient.

For any mixture, the binary Maxwell–Stefan diffusion coefficient $D_{i,j}$, represents the inverse drag coefficient of species i moving past species j ([Ref. 54–Ref. 57](#)). This

property is referred to as the Maxwell–Stefan diffusivity. The Maxwell–Stefan diffusivity is symmetric, $D_{i,j} = D_{j,i}$, and the diagonal elements $D_{i,i}$ are not used.

Gas Phase Diffusion Coefficient at Infinite Dilution

The following models are available for the diffusion coefficients at infinite dilution in the vapor phase:

- Fuller–Schettler–Giddings
- Wilke–Lee

Automatic When the Gas diffusivity property model is set to Automatic, the Fuller–Schettler–Giddings model is used, provided that the Fuller diffusion volume is known for both species (i and j), otherwise the Wilke–Lee model is used.

Fuller–Schettler–Giddings

Fuller and others (Ref. 58) modified the Chapman–Enskog relation to correlate binary diffusion coefficient for species i and j in the vapor phase according to the Fuller–Schettler–Giddings (FGS) model:

$$D_{i,j}^0 = \frac{1.01325 \times 10^{-2} T^{1.75} \sqrt{\frac{1}{M_i} + \frac{1}{M_j}}}{P \left(\left(\sum_i v \right)^{\frac{1}{3}} + \left(\sum_j v \right)^{\frac{1}{3}} \right)^2} \quad (10-230)$$

where T denotes the temperature (K), M_i the molecular weight of species i (g/mol) and P is the pressure (Pa). v_i are the atomic diffusion volumes (Fuller diffusion volume, cm^3), which are estimated using group contribution for each species (Ref. 59):

TABLE 10-7: ATOMIC AND STRUCTURAL DIFFUSION VOLUME INCREMENTS.

GROUP	CONTRIBUTION
C	15.9
H	2.31
O	6.11
N	4.54
F	14.7
Cl	21
Br	21.9

TABLE 10-7: ATOMIC AND STRUCTURAL DIFFUSION VOLUME INCREMENTS.

GROUP	CONTRIBUTION
I	29.8
S	22.9
Aromatic Ring	-18.3
Heterocyclic Ring	-18.3

For some simple molecules the values below, determined from regression, are used:

TABLE 10-8: DIFFUSION VOLUMES OF ATOM AND SIMPLE MOLECULES.

SPECIES	FULLER DIFFUSION VOLUME
He	2.67
Ne	5.98
Ar	16.2
Kr	24.5
Xe	32.7
H ₂	6.12
D ₂	6.84
N ₂	18.5
O ₂	16.3
CO	18
CO ₂	26.9
N ₂ O	35.9
NH ₃	20.7
H ₂ O	13.1
SF ₆	71.3
Cl ₂	38.4
Br ₂	69
SO ₂	41.8
Air	19.7

Wilke–Lee

Wilke and Lee (Ref. 60) also modified the Chapman–Enskog relation to correlate binary diffusion coefficient in vapor phase according to:

$$D_{i,j}^0 = 10^{-2} \times \frac{3.03 - \left(\frac{0.98}{\sqrt{MW_{i,j}}} \right) T^{1.5}}{P \sigma_{i,j}^2 \Omega_D \sqrt{MW_{i,j}}} \quad (10-231)$$

where

$$MW_{i,j} = \frac{2}{\frac{1}{M_i} + \frac{1}{M_j}} \quad (10-232)$$

The length scale $\sigma_{i,j}$ for the interaction is taken from the Lennard–Jones diameter parameters of species i and j :

$$\sigma_{i,j} = \frac{(\sigma_i^{LJ} + \sigma_j^{LJ})}{2} \quad (10-233)$$

If σ_i^{LJ} is not specified in the database, it is instead estimated from:

$$\sigma_i^{LJ} = 1.18 \times 10^{-8} V_{i,l,b}^{\frac{1}{3}} \quad (10-234)$$

where $V_{i,l,b}$ is the molar volume of species at normal boiling point.

The collision integral Ω_D is evaluated from (Ref. 61):

$$\begin{aligned} \Omega_D = & 1.06036 T^{*-0.15610} + 0.19300 \exp(-0.47635 T^*) \\ & + 1.03587 \exp(-1.52996 T^*) + 1.76474 \exp(-3.89411 T^*) \end{aligned} \quad (10-235)$$

with

$$T^* = \frac{T}{\varepsilon_{i,j}} \quad (10-236)$$

The energy scale $\varepsilon_{i,j}$ for the interaction is taken from the Lennard–Jones energy parameters of species i and j :

$$\varepsilon_{i,j} = \sqrt{\varepsilon_i^{LJ} \varepsilon_j^{LJ}} \quad (10-237)$$

If ε_i^{LJ} is not specified in the database, it is instead estimated from:

$$\frac{\varepsilon_i^{LJ}}{k} = 1.15 T_{i,l,b} \quad (10-238)$$

where k is the Boltzmann constant and $T_{i,l,b}$ is the normal boiling point temperature.

Gas Phase Maxwell–Stefan Diffusivity

For gas phase diffusion the Maxwell–Stefan diffusivities are defined from the models for gas phase diffusivity at infinite dilution

$$D_{i,j} = D_{i,j}^0 \quad (i \neq j) \quad (10-239)$$

All models for gas phase diffusion at infinite dilution are symmetric, the diffusivity of species i in species j equals that of species j in species i . In addition, under the ideal gas assumption, the Maxwell–Stefan diffusion coefficient matches the Fick diffusion coefficient. This implies that the Maxwell–Stefan gas diffusivities provided are independent of composition.

Liquid Phase Diffusion Coefficients at Infinite Dilution

The following models are available for the diffusion coefficients at infinite dilution in liquid phase:

- [Wilke–Chang](#)
- [Tyn–Calus](#)
- [Hayduk–Minhas](#)
- [Siddiqi–Lucas](#)
- [Erkey–Rodden–Akgerman](#)

Automatic When the Liquid diffusivity at infinite dilution property model is set to Automatic, a selection for each solute i in solvent j will be made from the models according to the following rules. Except in the case of a temperature correlation and the [Erkey–Rodden–Akgerman](#) model, all of these rules require that the log liquid viscosity correlation, $\ln \eta_j$ is available in the database for species j and that the liquid volume at normal boiling point, $V_{i,l,b}$ is available for the species i .

- If a temperature correlation is available for species i and j , it is used.
- If the solvent is water, the [Siddiqi–Lucas](#) correlation (for aqueous systems) is used.
- If the solute and solvent are both normal paraffins, the [Hayduk–Minhas](#) correlation (for normal paraffins) is used.
- If the solvent is a normal paraffin, and the liquid density correlation for the solvent is available, and the solute is hydrogen, carbon-monoxide or carbon-dioxide, the [Erkey–Rodden–Akgerman](#) correlation (for normal paraffins) is used.

- If parachors P_i and P_j are both available, and the liquid volume at normal boiling point, $V_{i,l,b}$ is available for the solvent, the [Tyn–Calus](#) correlation is used.
- If parachors P_i and P_j are both available, the [Hayduk–Minhas](#) correlation is used.
- If the solute and solvent are both organic molecules and the liquid volume at normal boiling point, $V_{i,l,b}$ is available for the solvent, the [Siddiqi–Lucas](#) method is used.
- If the molecular weight M_j is available for the solvent, the [Wilke–Chang](#) correlation is used.
- If the solvent is a normal paraffin, and the liquid density correlation for the solvent is available, and the solute is a normal paraffin, the [Erkey–Rodden–Akgerman](#) correlation (for normal paraffins) is used.
- If the solvent is a normal paraffin, and the liquid density correlation for the solvent is available, and the Lennard–Jones diameter for the solute is available, the [Erkey–Rodden–Akgerman](#) correlation (for normal paraffins) is used.

For the [Siddiqi–Lucas](#) method, a molecule is considered organic if it has at least one C atom bound to anything other than O or C atoms. This is determined by the SMILES formula, if available. If, for any pair of species, the required input data for none of the above models is available, the entire property liquid diffusion coefficient at infinite dilution is not available.

Wilke–Chang

The correlation by Wilke and Chang ([Ref. 62](#)) for liquid phase diffusion coefficients at infinite dilution is:

$$D_{i,j}^0 = 1.858795959 \times 10^{-18} \frac{T \sqrt{\phi_j M_j}}{\eta_j V_{i,l,b}^{0.6}} \quad (10-240)$$

Molecular weight, M_j , and log liquid viscosity correlation, $\ln \eta_j$, for species j and liquid molar volume at normal boiling point for species i , $V_{i,l,b}$, is required. The Wilke–Chang association parameter ϕ_j , if unavailable, is set to:

TABLE 10-9: ASSOCIATION PARAMETERS FOR SOLVENT.

SOLVENT	ASSOCIATION PARAMETER
Water	2.26 (Ref. 63)
Methanol	1.9
Ethanol	1.5
Others	1

Species are identified by their CAS number or SMILES formula. The Wilke–Chang correlation is not suitable for diffusion of water. If water is the solute, the correction suggested by Kooijman (Ref. 64) is applied where liquid molar volume of water at normal boiling point, $V_{\text{water},l,b}$ is multiplied by 4.5.

Tyn–Calus

The Correlation by Tyn and Calus (Ref. 65) for liquid diffusion coefficients at infinite dilution reads:

$$D_{i,j}^0 = 8.93 \times 10^{-16} \frac{T \left(V_{i,l,b}^{\frac{1}{6}} \right) P_j^{0.6}}{\eta_j \left(V_{j,l,b}^{\frac{1}{3}} \right) P_i^{0.6}} \quad (10-241)$$

The log liquid viscosity correlation $\ln \eta_j$ should be available for species j , The liquid volume at normal boiling point, $V_{i,l,b}$ and parachor, P_i should be available for both species i and j .

If the solvent is nonpolar (dipole moment is zero), and the solvent is methanol, ethanol or 1-butanol or if the solvent is a mono-hydroxy alcohol, both the liquid volume at normal boiling point, $V_{j,l,b}$ and the parachor, P_j are corrected by a factor of $8 \times 10^3 \eta_j$.

If the solute is water, both the liquid volume at normal boiling point, $V_{i,l,b}$ and parachor, P_i for the solute are corrected by a factor 2. This factor also applies if it is detected from the SMILE formula that the species is an organic acid (a carboxyl group is found), except in the cases where the solvent is water, methanol, or n-butanol.

Hayduk–Minhas

Hayduk and Minhas (Ref. 66) suggested three different correlations for liquid diffusion coefficients at infinite dilution.

Aqueous Solutions: in case the solvent is water (derived from CAS number or SMILES formula), the correlation reads:

$$D_{i,j}^0 = 1.25 \times 10^{-12} T^{1.52} \left(\frac{0.07244359601}{V_{i,l,b}^{0.19}} - 0.292 \right) \quad (10-242)$$

$$\times (\eta_j \times 10^3)^{\left(\frac{9.58 \times 10^{-6}}{V_{i,l,b}} - 1.12 \right)}$$

Normal paraffin solutions: In case both the solute and solvent are normal paraffins (derived from SMILES formula), the correlation reads:

$$D_{i,j}^0 = 7.30889362 \times 10^{-16} T^{1.47} \left(\frac{(\eta_j \times 10^3)^{\left(\frac{10.2 \times 10^{-6}}{V_{i,l,b}} - 0.791 \right)}}{V_{i,l,b}^{0.71}} \right) \quad (10-243)$$

For all other systems, the correlation is:

$$D_{i,j}^0 = 3.8934239 \times 10^{-16} \frac{T^{1.29} \sqrt{P_j}}{\eta_j^{0.92} (V_{j,l,b})^{0.23} P_i^{0.42}} \quad (10-244)$$

If the solvent is nonpolar (dipole moment is zero), and the solvent is methanol, ethanol or 1-butanol or if the solvent is a mono-hydroxy alcohol, both the liquid volume at normal boiling point, $V_{j,l,b}$ and the parachor, P_j are corrected by a factor of $8 \times 10^3 \eta_j$.

If the solute is water, both the liquid volume at normal boiling point, $V_{i,l,b}$ and parachor, P_i for solute are corrected by a factor 2. This factor also applies if it is detected from the SMILES formula that the species is an organic acid (a carboxyl group is found), except in the cases where the solvent is water, methanol, or n-butanol.

Siddiqi-Lucas

Siddiqi and Lucas (Ref. 67) suggested correlations for liquid diffusion coefficients at infinite dilution for aqueous system (including gases) and for organic solutions. For normal paraffins systems, they recommended the Hayduk-Minhas model.

For aqueous solutions:

$$D_{i,j}^0 = 1.295436901 \times 10^{-17} \frac{T}{\eta_j^{1.026} (V_{i,l,b})^{0.5473}} \quad (10-245)$$

For all other systems, the equation for organic solution is used as:

$$D_{i,j}^0 = 1.459473761 \times 10^{-15} \frac{T(V_{i,l,b}^{0.265})}{\eta_j^{0.907} (V_{i,l,b}^{0.45})} \quad (10-246)$$

Where T is the temperature, $V_{i,l,b}$ is the liquid volume at normal boiling point and η_j is the viscosity of the solvent.

Erkey–Rodden–Algerman

The correlation by Erkey and others (Ref. 68) for liquid diffusion coefficients at infinite dilution in normal paraffins is:

$$D_{i,j}^0 = 94.5 \times 10^{-9} \frac{\sqrt{T}(V - V_j^{\text{ref}}) \times 10^6}{M_i^{0.239} M_j^{0.781} (\sigma_i \sigma_j \times 10^{-20})^{1.134}} \quad (10-247)$$

where the reference volume is

$$V_j^{\text{ref}} = \frac{1}{\sqrt{2}} b_j N_{\text{Av}} \sigma_j^3 \quad (10-248)$$

N_{Av} is Avogadro's number, and the deviation from closest packing volume is given by

$$b_j = 1.206 + 0.0632 \left(\frac{\sigma_i}{\sigma_j} \right) \quad (10-249)$$

The correlation is fitted to normal paraffins, hydrogen, carbon monoxide and carbon dioxide diffusing in normal paraffins. The molecular weight M_i should be available for both solute and solvent. The Lennard–Jones diameter, σ_i is estimated from Bondi group contribution method (Ref. 69), and for some species are taken from Ref. 68 and Ref. 70 as:

TABLE 10-10: MOLECULAR DIAMETERS FOR SPECIES.

SPECIES	$\sigma \times 10^{10}$ (M)
H ₂	2.92
CO	3.72
CO ₂	3.97
n-C _j H _{2j+2}	$(21.82 + 32.44 * j)^{1/3}$

To prevent the diffusion coefficients from becoming negative, the minimum difference of $(V - V_j^{\text{ref}})$ is considered to be 10^{-12} mol/m³.

Liquid Phase Maxwell–Stefan Diffusivity

The Maxwell–Stefan liquid diffusion coefficients are calculated from the liquid diffusion coefficients at infinite dilution. The diagonal values should be ignored and are set to zero. The Vignes (Ref. 71) model for diffusion in binary solutions can be extended to multicomponent systems (Ref. 72):

$$D_{i,j} = \prod_{k=1}^n (D_{i,j,x_k \rightarrow 1})^{x_k} \quad (10-250)$$

where $D_{i,j,x_k \rightarrow 1}$ denotes the Maxwell–Stefan liquid diffusion coefficient for species i and j in the limited of pure species k . If $k = j$, it represents a binary system of species i and j where i is infinitely diluted. In addition, at infinite dilution the thermodynamics factor (activity) (Ref. 57) becomes unity and the Maxwell–Stefan diffusivity equals to Fick diffusivity:

$$D_{i,j,x_j \rightarrow 1} = D_{i,j}^0 = D_{i,j}^0 \quad (10-251)$$

Similarly,

$$D_{i,j,x_i \rightarrow 1} = D_{j,i}^0 = D_{j,i}^0 \quad (10-252)$$

Models for the $D_{i,j,x_k \rightarrow 1}$ for $k \neq i$ and $k \neq j$ remain to be defined in such a way that symmetry is ensured:

$$D_{i,j} = D_{j,i} \quad (10-253)$$

and to ensure continuity if both species i and j vanish:

$$\lim_{x_i \rightarrow 0} D_{i,j,x_k \rightarrow 1} = \lim_{x_j \rightarrow 0} D_{i,j,x_k \rightarrow 1} \quad (10-254)$$

For binary systems, Equation 10-250 reduces to the Vignes interpolation formula.

Wesselingh–Krishna

Wesselingh and Krishna (Ref. 72) proposed:

$$D_{i,j,x_k \rightarrow 1} = \sqrt{D_{i,j}^0 D_{j,i}^0} \quad (10-255)$$

leading to:

$$D_{i,j} = (D_{i,j}^0)^{(1+x_j-x_i)/2} (D_{j,i}^0)^{(1+x_i-x_j)/2} \quad (10-256)$$

Kooijman–Taylor

Kooijman and Taylor (Ref. 73) found on a limited number of systems that this provides better results:

$$D_{i,j,x_k \rightarrow 1} = \sqrt{D_{i,k}^0 D_{j,k}^0} \quad (k \neq i,j) \quad (10-257)$$

leading to:

$$D_{i,j} = (D_{i,j}^0)^{x_j} (D_{j,i}^0)^{x_i} \prod_{\substack{k=1 \\ k \neq i,j}}^n (\sqrt{D_{i,k}^0 D_{j,k}^0})^{x_k} \quad (10-258)$$

Wesselingh and Bollen (Ref. 74) asserted that this is a reasonable estimate.

Krishna–van Baten

Krishna and van Baten (Ref. 75), on the basis of data obtained from molecular dynamic simulations, proposed the following Vignes-based (Ref. 71) interpolation:

$$D_{i,j,x_k \rightarrow 1} = (D_{i,k}^0)^{\left(\frac{x_i}{x_i+x_j}\right)} (D_{j,k}^0)^{\left(\frac{x_j}{x_i+x_j}\right)} \quad (k \neq i,j) \quad (10-259)$$

The model reduces to the Kooijman–Taylor model for $x_i = x_j$. The value of $D_{i,j,x_k \rightarrow 1}$ is undefined in the limit of both $x_i \rightarrow 0$ and $x_j \rightarrow 0$. From a physical point of view this is inconsequential as the value cancels out in the expressions obtained for the fluxes using the Maxwell–Stefan equations. Nevertheless, in order to obtain well-defined values and composition derivatives of $D_{i,j,x_k \rightarrow 1}$ itself, the equation is modified to:

$$D_{i,j,x_k \rightarrow 1} = (D_{i,k}^0)^{\left(\frac{x_i + \varepsilon_x}{x_i + x_j + 2\varepsilon_x}\right)} (D_{j,k}^0)^{\left(\frac{x_j + \varepsilon_x}{x_i + x_j + 2\varepsilon_x}\right)} \quad (k \neq i,j) \quad (10-260)$$

where $\varepsilon_x = 10^{-10}$ is taken as a small composition. The limiting case for both $x_i \rightarrow 0$ and $x_j \rightarrow 0$ also reduces to the Kooijman–Taylor model. This equation leads to:

$$D_{i,j} = (D_{i,j}^0)^{x_j} (D_{j,i}^0)^{x_i} \prod_{\substack{k=1 \\ k \neq i,j}}^n \left((D_{i,k}^0)^{\frac{x_i + \epsilon_x}{x_i + x_j + 2\epsilon_x}} (D_{j,k}^0)^{\frac{x_j + \epsilon_x}{x_i + x_j + 2\epsilon_x}} \right)^{x_k} \quad (10-261)$$

Surface Tension

Below the available surface tension models are presented.

GAS-LIQUID SURFACE TENSION

Ideal

The gas-liquid surface tension is predicted by ideally mixing the pure species correlations. It is independent of pressure, vapor temperature or composition.

$$\sigma_{vl} = \sum_i x_{i,l} \sigma_{i,vl} \quad (10-262)$$

where the vapor-liquid surface tension correlations, $\sigma_{i,vl}$, must be specified for all species i , and are evaluated at the temperature of the liquid phase.

Winterfeld

Following Winterfeld (Ref. 76), the vapor-liquid surface tension is predicted by mixing the pure species correlations according to

$$\sigma_{vl} = \frac{\sum_i \sum_j \frac{x_{i,l} x_{j,l} \sqrt{\sigma_{i,vl} \sigma_{j,vl}}}{\rho_{i,l} \rho_{j,l}}}{\left(\sum_i \frac{x_{i,l}}{\rho_{i,l}} \right)^2} \quad (10-263)$$

It is independent of pressure, vapor temperature and composition. The vapor-liquid surface tension correlations and liquid density correlations must be specified for all species i , and are evaluated at the temperature of the liquid phase.

References

1. A. Akerberg, *CFD analyses of the gas flow inside the vessel of a hot isostatic press*, Master of Science Thesis, KTH School of Industrial Engineering and Management, Stockholm, Sweden, 2012.

2. M.A. Trebble and P.R. Bishnoi, "Accuracy and consistency comparisons of ten cubic equations of state for polar and non-polar compounds", *Fluid Phase Equilibria*, vol. 29, pp. 465–474, 1986.
3. B.E. Poling, J.M. Prausnitz, and J.P. O'Connell, *The Properties of Gases and Liquids*, McGraw Hill, international edition, 2007.
4. M.C. Clapeyron, "Mémoire sur la puissance motrice de la chaleur," *Journal de l'École polytechnique*, vol. 23, pp. 153–190, 1834 (in French).
5. D.Y. Peng and D. Robinson, "A new two-constant equation of state," *Industrial and Engineering Chemistry: Fundamentals*, vol. 15, pp. 59–64, 1976.
6. C.H. Twu, J.E. Coon, and J.R. Cunningham, "A new generalized alpha function for a cubic equation of state, Part 1, Peng–Robinson equation," *Fluid Phase Equilibria*, vol. 105, pp. 49–59, 1995.
7. O. Redlich and J.N.S. Kwong, "On the thermodynamics of solutions an equation of state, fugacities of gaseous solutions," *Chem. Rev.*, vol. 44, no. 1, pp. 233–244, 1949.
8. G. Soave, "Equilibrium constants from a modified Redlich–Kwong equation of state," *Chem. Eng. Sci.*, vol. 27, no. 6, pp. 1197–1203, 1972.
9. M.S. Graboski and T.E. Daubert, "A modified Soave equation of state for phase equilibrium calculations, 3, systems containing hydrogen," *Ind. Eng. Chem. Process. Des. Dev.*, vol. 18, no. 2, pp. 300–306, 1979.
10. J.R. Cooper, "Revised Release on the IAPWS Industrial Formulation 1997 for the Thermodynamic Properties of Water and Steam", *The International Association for the Properties of Water and Steam*, IAPWS R7-97, 2012.
11. K. Watanabe, "Revised Supplementary Release on Backward Equations for the Functions $T(p,h)$, $v(p,h)$ and $T(p,s)$, $v(p,s)$ for Region 3 of the IAPWS Industrial Formulation 1997 for the Thermodynamic Properties of Water and Steam," *The International Association for the Properties of Water and Steam*, Kyoto, Japan, Sep. 2004.
12. F. Marsik, "Supplementary Release on Backward Equations for Specific Volume as a Function of Pressure and Temperature $v(p,T)$ for Region 3 of the IAPWS Industrial Formulation 1997 for the Thermodynamics Properties of Water and Steam," *The International Association for the Properties of Water and Steam*, Santorini, Greece, July 2005.

13. K.C. Chao and J.D. Seader, "A general correlation of vapor-liquid equilibria in hydrocarbon mixtures," *AIChE J.*, vol. 7, no. 4, pp. 598–605, 1961.
14. J.H. Hildebrand and R.L. Scott, "The solubility of non-electrolytes," *J. Phys. Chem.*, vol. 55, no. 4, pp. 619–620, 1951.
15. H.G. Grayson and C.W. Streed, "Vapor-liquid equilibria for high temperature, high pressure hydrogen-hydrocarbon systems," *6th World Petroleum Congress*, 19–26 June, Frankfurt am Main, Germany, IV, pp. 169–180, 1963.
16. J.H. Hildebrand, J.M. Prausnitz, and R.L. Scott. *Regular and Related Solutions*, Van Nostrand Reinhold Co., 1970.
17. G.M. Wilson, "Vapor-liquid equilibrium. xi. a new expression for the excess free energy of mixing," *J. Am. Chem. Soc.*, vol. 86, pp. 127–130, 1964.
18. H. Renon and J.M. Prausnitz, "Local compositions in thermodynamic excess functions for liquid mixtures," *AIChE J.*, vol. 14, no. 1, pp. 135–144, 1968.
19. D.S. Abrams and J.M. Prausnitz, "Statistical thermodynamics of liquid mixtures: A new expression for the excess Gibbs energy of partly or completely miscible systems," *AIChE J.*, vol. 21, no. 1, pp. 116–128, 1975.
20. A. Fredenslund, R.L. Jones, and J.M. Prausnitz, "Group-contribution estimation of activity coefficients in nonideal liquid mixtures," *AIChE J.*, vol. 21, no. 6, pp. 1086–1099, 1975.
21. S. Skjold-Joergensen, B. Kolbe, J. Gmehling, and P. Rasmussen, "Vapor-liquid equilibria by unifac group contribution. revision and extension," *Ind. Eng. Chem. Process. Des. Dev.*, vol. 18, no. 4, pp. 714–722, 1979.
22. J. Gmehling, P. Rasmussen, and A. Fredenslund, "Vapor-liquid equilibria by unifac group contribution. revision and extension. 2," *Ind. Eng. Chem. Process. Des. Dev.*, vol. 21, no. 1, pp. 118–127, 1982.
23. E.A. Macedo, U. Weidlich, J. Gmehling, and P. Rasmussen, "Vapor-liquid equilibria by unifac group contribution. 3. Revision and extension," *Ind. Eng. Chem. Process. Des. Dev.*, vol. 22, no. 4, pp. 676–678, 1983.
24. D. Tiegs, J. Gmehling, P. Rasmussen P, and A. Fredenslund, "Vapor-liquid equilibria by unifac group contribution. 4. Revision and extension," *Ind. Eng. Chem. Process. Des. Dev.*, vol. 26, no. 1, pp. 159–161, 1987.

25. H.K. Hansen, P. Rasmussen, A. Fredenslund, M. Schiller, and J. Gmehling, "Vapor-liquid equilibria by unifac group contribution. 5. Revision and extension," *Ind. Eng. Chem. Process. Des. Dev.*, vol. 30, no. 10, pp. 2352–2355, 1991.
26. R. Wittig, J. Lohmann, and J. Gmehling, "Vapor-liquid equilibria by unifac group contribution. 6. Revision and extension," *Ind. Eng. Chem. Process. Des. Dev.*, vol. 42, no. 1, pp. 183–188, 2003.
27. K. Balslev and J. Abildskov, "Unifac parameters for four new groups," *Ind. Eng. Chem. Res.*, vol. 41, pp. 2047–2057, 2002.
28. R.W. Hankinson and G.H. Thomson, "A new correlation for saturated densities of liquid and their mixtures," *AIChE J.*, vol. 25, no. 4, pp. 653–663, 1979.
29. H.G. Rackett, "Equation of state for saturated liquids," *J. Chem. Eng. Data*, vol. 15, no. 4, pp. 514–517, 1970.
30. L.I. Stiel and G. Thodos, "The thermal conductivity of nonpolar substances in the dense gaseous and liquid regions," *AIChE J.*, vol. 10, no. 1, pp. 26–30, 1964.
31. M. Yorzane, S. Yoshimura, H. Masuoka, and H. Yoshida, "Thermal conductivities of binary gas mixtures at high pressures: nitrogen-oxygen, nitrogen-argon, carbon dioxide-argon, and carbon dioxide-methane," *Industrial & Engineering Chemistry Fundamentals*, vol. 22, no. 4, pp. 458–463, 1983.
32. A.L. Lindsay and L.A. Bromley, "Thermal conductivity of gas mixtures," *Industrial and Engineering Chemistry*, vol. 42, no. 8, pp. 1508–1511, 1950.
33. A. Wassiljewa, "Heat conduction in gas mixtures," *Physikalische Zeitschrift*, vol. 5, no. 22, pp. 737–742, 1904.
34. J.R. Cooper, "Release on the IAPS Formulation 1985 for the Thermal Conductivity of Ordinary Water Substance," *The International Association for the Properties of Water and Steam*, Berlin, Germany, Sep. 2008.
35. C.R. Wilke, "A viscosity equation for gas mixtures," *J. Chem. Phys.*, vol. 18, no. 4, pp. 517–520, 1950.
36. R.S. Brokaw, "Approximate formulas for the viscosity and thermal conductivity of gas mixtures. ii," *J. Chem. Phys.*, vol. 42, no. 4, pp. 1140–1147, 1965.
37. J.E. Lennard-Jones, "On the determination of molecular fields I. from the variation of the viscosity of a gas with temperature," *Proceedings of the Royal Society of London. Series A, Containing Papers of a Mathematical and Physical Character*, vol. 106, pp. 441–462, 1924.

38. W.H. Stockmayer, “Second virial coefficients of polar gases,” *J. Chem. Phys.*, vol. 9, pp. 398–402, 1941.
39. F.M. Mourits and F.H.A. Rummens, “A critical evaluation of Lennard–Jones and Stockmayer potential parameters and of some correlation methods,” *Can. J. Chem. Eng.*, vol. 55, pp. 3007–3020, 1977.
40. T.A. Davidson, “A Simple and Accurate Method for Calculating Viscosity of Gaseous Mixtures”, *Report of Investigations 9456*, United States Department of the Interior, Bureau of Mines, 1993.
41. J.A. Jossi, L.I. Stiel, and G. Thodos, “The viscosity of pure substances in the dense gaseous and liquid phases,” *AIChE J.*, vol. 8, no. 1, pp. 59–63, 1962.
42. K.S. Pedersen and P.L. Christensen, “Phase Behavior of Petroleum Reservoir Fluids,” *CRC Press/Taylor & Francis Group*, 2007.
43. K.S. Pedersen, A. Fredenslund, P.L. Christensen, and P. Thomassen, “Viscosity of crude oils,” *Chem. Eng. Sci.*, vol. 39, no. 6, pp. 1011–1016, 1984.
44. H.J.M. Hanley, W.M. Haynes, and R.D. McCarty, “The viscosity and thermal conductivity coefficients for dense gaseous and liquid methane,” *J. Chem. Phys.*, vol. 6, no. 2, pp. 597–609, 1977.
45. K.S. Pedersen and A. Fredenslund, “An improved corresponding states model for the prediction of oil and gas viscosities and thermal conductivities,” *Chem. Eng. Sci.*, vol. 42, no. 1, pp. 182–186, 1987.
46. R.D. McCarty, “A modified Benedict-Webb-Rubin equation of state for methane using recent experimental data,” *Cryogenics*, pp. 276–280, May 1974.
47. S. Murad and K.E. Gubbins, “Corresponding states correlation for thermal conductivity of dense fluids,” *Chem. Eng. Sci.*, vol. 32, no. 5, pp. 499–505, 1977.
48. J.R. Cooper, “Revised Release on the IAPWS Formulation 2008 for the Viscosity of Ordinary Water Substance”, *The International Association for the Properties of Water and Steam*, Berlin, Germany, Sep. 2008.
49. K. Dacic, “Revised Release on the Pressure along the Melting and Sublimation Curves of Ordinary Water Substance”, *The International Association for the Properties of Water and Steam*, Plzen, Czech Republic, Sep. 2011.
50. J. Gabitto and M. Barrufet, “Experimental and theoretical determination of heavy oil viscosity under reservoir conditions,” *Technical reports*, Office of Fossil Energy, USDOE Office of Fossil Energy, United States, 2002.

51. A. Missenard, "Conductivité thermique des liquides organiques d'une série ou d'un 'groupe de liquides'," *Revue Générale de Thermique*, vol. 101, no. 5, pp. 649–660, 1970 (in French).
52. R.L. Rowley, G.L. White, and M. Chiu, "Ternary liquid mixture thermal conductivities," *Chem. Eng. Sci.*, vol. 43, no. 2, pp. 361–371, 1988.
53. R.L. Rowley, "A local composition model for multicomponent liquid mixture thermal conductivities," *Chem. Eng. Sci.*, vol. 37, no. 6, pp. 897–904, 1982.
54. W.D. Niven, "The Scientific Papers of James Clerk Maxwell", *Cambridge University Press*, 1890.
55. J.C. Maxwell, "On the dynamical theory of gases," *Philos. Trans. R. Soc.*, vol. 157, pp. 49–88, 1867.
56. J. Stefan, "Über das Gleichgewicht und die Bewegung, insbesondere die Diffusion von Gasgemengen," *Sitzungsberichte der Kaiserlichen Akademie der Wissenschaften Wien, 2te Abteilung a*, vol. 63, pp. 63–124, 1871.
57. R. Taylor and R. Krishna, "Multicomponent Mass Transfer," *Wiley-Interscience*, 1993.
58. E.N. Fuller, P.D. Schettler and J.C. Giddings, "A new method for prediction of binary gas-phase diffusion coefficients," *Industrial and Engineering Chemistry*, vol. 5, pp. 19–27, 1966.
59. E.N. Fuller, K. Ensley and J.C. Giddings, "Diffusion of halogenated hydrocarbons in helium. The effect of structure on collision cross sections," *J. Phys. Chem.*, vol. 73, no. 11, pp. 3679–3685, 1969.
60. C.R. Wilke and C.Y. Lee, "Estimation of diffusion coefficients for gases and vapors," *Industrial and Engineering Chemistry*, vol. 47, no. 6, pp. 1253–1257, 1955.
61. P.D. Neufeld, A.R. Janzen, and R.A. Aziz, "Empirical equations to calculate 16 of the transport collision integrals $\Omega^{(l,s)*}$ for the Lennard–Jones (12-6) potential," *J. Chem. Phys.*, vol. 57, pp. 1100–1102, 1972.
62. C.R. Wilke and P. Chang, "Correlation of diffusion coefficients in dilute solutions," *AICHE J.*, vol. 1, no. 2, pp. 264–270, 1972.
63. W. Hayduk and H. Laudie, "Prediction of diffusion coefficients for nonelectrolytes in dilute aqueous solutions," *AICHE J.*, vol. 20, no. 3, pp. 611–615, 1974.

64. H.A. Kooijman, "A modification of the Stokes-Einstein equation for diffusivities in dilute binary mixture," *Ind. Eng. Chem.*, vol. 41, pp. 3326–3328, 2002.
65. M.T. Tyn and W.F. Calus, "Diffusion coefficients in dilute binary mixtures," *J. Chem. Eng. Data*, vol. 20, no. 1, pp. 106–109, 1975.
66. W. Hayduk and B.S. Minhas, "Correlation for prediction of molecular diffusivities in liquids," *Can. J. Chem. Eng.*, vol. 60, no. 2, pp. 295–299, 1983.
67. M.A. Siddiqi and K. Lucas, "Correlations for prediction of diffusion in liquids," *Can. J. Chem. Eng.*, vol. 64, pp. 839–843, 1986.
68. C. Erkey, J.B. Rodden and A. Akgerman, "A correlation for predicting diffusion coefficients in alkanes," *Can. J. Chem. Eng.*, vol. 68, pp. 661–665, 1990.
69. A. Bondi, "van der Waals Volumes and Radii," *J. Phys. Chem.*, vol. 68, no. 3, pp. 441–451, 1964.
70. J.O. Hirschfelder, C.F. Curtiss and R.B. Bird, "The Molecular Theory of Gases and Liquids", *Wiley-Interscience*, 1964.
71. A. Vignes, "Diffusion in Binary Solutions," *Ind. Eng. Chem. Fundam.*, vol. 5, pp. 189–199, 1966.
72. J.A. Wesselingh and R. Krishna, "Mass Transfer", *Ellis Horwood Ltd*, 1990, ISBN: 0-13-553165-9.
73. H.A. Kooijman and R. Taylor, "Estimation of diffusion coefficients in multicomponent liquid systems", *Ind. Eng. Chem.*, vol. 30, pp. 1217–1222, 1991.
74. J.A. Wesselingh and A.M. Bollen, "Multicomponent diffusivities from the free volume theory", *Chem. Eng. Res. Des.*, vol. 75, no. 6, pp. 590–602, 1997.
75. R. Krishna and J.M. van Baten, "The Darken relation for multicomponent diffusion in liquid mixtures of linear alkanes: An investigation using molecular dynamics (MD) simulations," *Ind. Eng. Chem.*, vol. 44, pp. 6939–6947, 2005.
76. P.H. Winterfeld, L.E. Scriven, and H.T. Davis, "An approximate theory of interfacial tension of multicomponent systems: Applications binary liquid-vapor tensions," *AICHE J.*, vol. 24, no. 6, pp. 1010–1014, 1978
77. E.C. Carlson, "Don't Gamble With Physical Properties For Simulation", *Chem. Eng. Prog.*, vol. 92, no. 10, pp. 35–46, 1996.



Multiphysics Coupling Nodes

The Battery Design Module has multiphysics couplings available under certain conditions.

When a predefined multiphysics interface is added from the **Model Wizard** or **Add Physics** windows, it adds the constituent interfaces and the **Multiphysics Couplings** node, which automatically includes one or more multiphysics couplings.

If the constituent physics interfaces are added one at a time, then it adds an empty **Multiphysics Couplings** node. When you right-click this node, you can choose from the available multiphysics couplings.



[The Multiphysics Branch](#) in the *COMSOL Multiphysics Reference Manual*.

In this chapter, the following multiphysics couplings nodes are described:

- [Deforming Electrode Surface](#)
- [Space Charge Density Coupling](#)
- [Nondeforming Boundary](#)
- [Electrochemical Heating](#)
- [Potential Coupling](#)

Deforming Electrode Surface

Use the **Deforming Electrode Surface** multiphysics coupling to model deformation of the geometry due to an electrochemical deposition-dissolution process.

The node uses the deposition-dissolution velocity of an Electrode Surface boundary in an Electrochemistry interface to apply a deformation velocity on to a deforming boundary.

Special conditions for the tangential velocity at points (2D) and edges (3D) shared with nondeforming surfaces apply, as described in the theory section.

The node, available as a multiphysics coupling node, is only applicable when both the Electrochemistry interface (Primary/Secondary/Tertiary Current Distribution or Lithium-Ion Battery or Battery with Binary Electrolyte) and a Deformed Geometry node are added to a component.

MOVING BOUNDARY SMOOTHING

Certain electrode deformation problems are inherently unstable. The Moving Boundary Smoothing will stabilize the moving boundary by applying a fictitious surface tension. Use the **Moving boundary smoothing tuning parameter**, δ_{mbs} , to control smoothing. A higher value means more smoothing.

RECOMMENDED SETTINGS IN THE COUPLED DEFORMED GEOMETRY INTERFACE

Predefined multiphysics interfaces are available from the model wizard that will automatically add and set up the coupling between a current distribution interface and the deformed geometry node. However, you can also add a Deformed Geometry interface manually to an already existing model.

The following settings are recommended in the Deformed Geometry interface if you are manually setting up the coupling between a Deformed Geometry interface and an

Electrochemistry interface using the Deforming Electrode Surface and Nondeforming Boundary multiphysics coupling nodes:

- At the Deformed Geometry interface node, change the Geometry shape order to 1 and Mesh smoothing type to Hyperelastic
- Clear all the check boxes at the default Prescribed Mesh Displacement boundary feature node
- Add Free Deformation domain node and make sure it is selected on the deforming domains of the geometry

[Tangential Velocities at the Intersection Between a Depositing and a Nondepositing Boundary](#)

Nondeforming Boundary

Use the **Nondeforming Boundary** multiphysics coupling to define boundaries that do not undergo deformation in the normal direction.

A **Nondeforming Boundary** can be applied to external boundaries of an electrolyte and is typically used to specify an insulator, a nondissolving/depositing electrode surface or a symmetry boundary in a problem.

The node, available as a multiphysics coupling node, is only applicable when both the Electrochemistry interface (Primary/Secondary/Tertiary Current Distribution or Lithium-Ion Battery or Battery with Binary Electrolyte) and a Deformed Geometry node are added to a component.

Zero normal displacement is implemented using pointwise constraints, which may be more numerically stable, but should typically only be used for planar boundaries since the boundary is effectively fixed in the tangential direction if the curvature of the boundary is nonzero.

As a rule of thumb: use **Zero normal displacement** for planar boundaries and **Zero normal velocity** for curved boundaries.

For 3D components, and when **Zero normal displacement** is selected, the deformation may be further stabilized by enabling the **Allow deformation along specified line only**. The specified line must be parallel to the boundary in the nondeformed geometry.

See also the [Deforming Electrode Surface](#) node.

Electrochemical Heating

Use the **Electrochemical Heating** multiphysics coupling () to define domain and boundary heat sources in a heat transfer interface, based on the sum of irreversible (Joule heating and activation losses) and reversible heat in an electrochemistry interface. The node also defines the temperature in the electrochemistry interface to be equal to that of the heat transfer interface.

The settings of this node are similar to the **Electromagnetic Heating** node, described in the *COMSOL Multiphysics Reference Manual*.



Theory for Electrochemical Heat Sources

Potential Coupling

The **Potential Coupling** multiphysics coupling () applies the electrolyte potential variable from the source interface into the model inputs of the destination interface. The potential variable is typically used to compute the migration flux in the destination interface.

COUPLED INTERFACES

Specify the physics interface that provides the potential (Electrostatics, for instance) in the **Source** list and the Chemical Species Transport interface in the **Destination** list.



Space Charge Density Coupling

The **Space Charge Density Coupling** multiphysics coupling () computes the local space charge, based on the local concentrations and species charges in a Chemical Species Transport interface, and adds it to Poisson's equation in an Electrostatics interface.

COUPLED INTERFACES

Specify the Chemical Species Transport interface in the **Source** list and the Electrostatics interface in the **Destination** list.

Parameter Estimation

Battery models many times contain unknown parameters, for instance diffusion constants or rate constants, that are hard to measure in separate experiments outside (ex-situ) a battery cell. To fit model parameter values to experimental data, the **Parameter Estimation** () node, which may be added to a **Study** () node in the model builder tree, can be used.

The Battery Design Module includes the Parameter Estimation node, together with the BOBYQA, IPOPT, and Levenberg–Marquardt optimization solvers, which may be used to perform parameter fitting of both stationary and time-dependent models.

The documentation of the parameter estimation node and the optimization solvers is found in the *Optimization Module User's Guide*, which is supplied with the Battery Design Module irrespective of whether a separate Optimization Module license is purchased.



- *Parameter Estimation of a Time-Dependent Lumped Battery Model*: Application Library path **Battery_Design_Module/Batteries_Lithium-Ion/lumped_li_battery_parameter_estimation**

Glossary

This [Glossary of Terms](#) contains application-specific terms used in the Battery Design Module software and documentation. For finite element modeling terms, mathematical terms, and geometry and CAD terms, see the glossary in the *COMSOL Multiphysics Reference Manual*. For references to more information about a term, see the index.

Glossary of Terms

anode An [electrode](#) where [oxidation](#) occurs. Anodic charge transfer current densities and overpotentials are positive by definition. The negative electrode of a battery is commonly referred to as “anode”, although this is strictly correct during discharge only.

cathode An [electrode](#) where [reduction](#) occurs. Cathodic charge transfer current densities and overpotentials are negative by definition. The positive electrode of a battery is commonly referred to as “cathode”, although this is strictly correct during discharge only.

cell voltage The difference in potential over an electrochemical cell.

charge transfer reaction A reaction during which charge is transferred from an electron conducting phase (electrode) to an ion conducting phase (electrolyte).

charge transfer current density The current density at an electrolyte-electrode interface associated with a [charge transfer reaction](#).

concentrated electrolyte An [electrolyte](#) where the concentration of charged species is so high that the interactions (friction forces) between the ions needs to be considered. See also [diluted electrolyte](#).

current collector A part of an electrochemical device with high electric conductivity for conducting current out of the cell. See also [current feeder](#).

current feeder A part of an electrochemical device with high electric conductivity for conducting current into the cell. See also [current collector](#).

diluted electrolyte An [electrolyte](#) where the charged species are diluted in a solvent so that the interaction between the ions can be neglected. See also [concentrated electrolyte](#).

electric potential The potential in the electrode (electron conducting) phase, denoted ϕ_s (phis).

electrode An electron conductor.

electrode reaction See [charge transfer reaction](#).

electrokinetic flow Transport of fluid or charged particles within a fluid by means of electric fields.

electrolyte An ion conductor.

electrolyte potential The potential in the electrolyte (ionic) phase, denoted ϕ_l (phil).

electroneutrality A situation where the net charge of any small control volume of a domain is zero. Electroneutrality can usually be assumed for electrolytes, with an exception for the very proximity of the electrolyte-electrode interface, which is due to the charge separation within the electrochemical double layer.

equilibrium potential The potential difference between the electrode and electrolyte at which the net current density of an [electrode reaction](#) is zero.

Faraday's Law A mathematical expression relating the flux of a species over an electrode-electrolyte interphase to be proportional to the charge transfer current density.

gas diffusion electrode (GDE) A [porous electrode](#) that also includes gas pores in the porous matrix.

GDE See [gas diffusion electrode \(GDE\)](#).

Gibbs free energy A thermodynamic potential that depends on the enthalpy and entropy of the reacting species.

intrinsic volume averages The physical properties of the fluid, such as density, viscosity, and pressure.

intercalation The process of ions reacting on the surface of a host particle to form a solid, intercalated, species within the host. The intercalated species can then be transported further into the particle by diffusion processes.

migration The transport of charged species in an electrolyte due to the electric force imposed by the electric field.

morphology correction parameter A correction parameter that is used to account for morphology effects of a porous structure.

Nernst–Planck equation A commonly used equation for describing the transport of charged species in a [diluted electrolyte](#). The equation includes transport due to diffusion, [migration](#) and convection. The Nernst–Planck equation can be modeled in COMSOL Multiphysics using the Tertiary Current Distribution, Nernst–Planck interface (and the Transport of Diluted Species interface). The Nernst–Planck equation is often combined with an electroneutrality condition.

Nernst–Planck–Poisson equation In certain situations, for instance when striving to resolve the electrochemical double layer at an electrode, and [electroneutrality](#) cannot be assumed, the [Nernst–Planck equation](#) is combined with the [Poisson’s equation](#) for describing the charge density.

overpotential A deviation from the [equilibrium potential](#).

oxidation A [charge transfer reaction](#) where electrons are produced.

PEMFC An abbreviation for *proton exchange membrane fuel cell*.

perfectly mixed electrolyte. An electrolyte where no concentration gradients are present, for instance due to stirring. See also [secondary current distribution](#).

primary current distribution The current distribution that is established when overpotentials can be neglected — that is, when the current distribution is governed by the electrolyte and electrode conductivities only. See also [secondary current distribution](#) and [tertiary current distribution](#).

Poisson’s equation An equation for relating the electric field to the space charge density. Can be modeled in COMSOL using the Electrostatics interface.

pore electrolyte An electrolyte in the pores of a porous matrix. See [porous electrode](#).

porous electrode A porous matrix containing both electron conducting and ion conducting media.

potentiostat A device that monitors and controls the potential of an electrode versus a [reference electrode](#).

reduction A charge transfer reaction where electrons are consumed.

reference electrode An electrode used for reference when defining the potentials of the electrodes in a cell. A good reference electrode is stable and does not vary in potential. Typically no net reactions occur at a reference electrode surface, and the net current density is zero.

resistive film A film with ohmic resistivity, typically formed as a result of electrode reactions.

secondary current distribution The current distribution that is established when concentration overpotentials can be neglected — that is, when the current distribution is governed by the activation overpotentials and the electrolyte conductivity. See also [tertiary current distribution](#) and [primary current distribution](#). Note that COMSOL models using the Secondary Current Distribution interface can in fact be modeling a [tertiary current distribution](#) because mass transport activation losses can be present in the electrode reaction current density expressions.

Soret effect Mass diffusion in multicomponent mixtures due to temperature gradients.

SOFC An abbreviation for *solid oxide fuel cell*.

solid-electrolyte interphase (SEI) A resistive and passivating layer formed on the graphite electrode particles in the negative electrode of a lithium-ion battery.

stoichiometric coefficients The number of species reacting in a reaction formula. In a redox reaction the oxidized species have negative sign and the reduced species have positive sign by convention.

superficial volume averages The flow velocities, which correspond to a unit volume of the medium including both pores and matrix. These are sometimes called Darcy velocities, defined as volume flow rates per unit cross section of the medium.

supporting electrolyte An electrolyte with an excess of charge carriers so that the conductivity can be assumed not to be affected by the currents flowing in the cell.

surface molar flux The tangential flux in the surface dimension as governed by diffusion according to Fick's law.

tertiary current distribution The current distribution that is established when concentration overpotentials cannot be neglected — that is, when the current

distribution is governed by the activation and concentration overpotentials, as well as the electrolyte conductivity. The electrolyte conductivity can also be nonconstant due to the currents flowing in the cell. See also [secondary current distribution](#) and [primary current distribution](#).

transport number The amount of the current that is transported by one of the species in a binary electrolyte. Also called the *transference number*.

I n d e x

- A**
 - absolute pressure 544, 626
 - activation overpotential 232, 239, 264
 - activity dependence 122
 - additional porous electrode material
 - (node) 130
 - adsorption 372, 383
 - ammeter (node) 306
 - amperometric sensing 261
 - analyte 261
 - anodes 40
 - anodic Tafel equation 242
 - anodic transfer coefficient 233
 - Application Libraries window 32
 - application library examples
 - battery with binary electrolyte interface 93
 - contact impedance 300
 - convection and diffusion 349
 - Darcy's law 567
 - electric currents 292
 - electrical circuits 69
 - electrolyte-electrode domain interface 206, 221
 - electrostatics 274
 - infinite electrolyte 182
 - laminar flow 542
 - lead-acid battery interface 85, 97, 105, 109, 114, 116
 - lithium-ion battery interface 83, 795
 - migration in electric field 349
 - secondary current distribution 179
 - storage model 600
 - surface reactions 457
 - tertiary current distribution, Nernst-Planck 190
 - transport of concentrated species 396
 - transport of diluted species 342
 - Arrhenius parameters 429
 - atmosphere/gauge (node) 595
 - average linear velocity 666
- B**
 - base node 313
 - battery with binary electrolyte interface
 - 89
 - theory 146
 - bipolar junction transistor 313
 - boundary current source (node) 226, 297
 - boundary electrolyte potential 213, 453
 - boundary nodes
 - battery interfaces 120
 - Brinkman equations 620
 - Darcy's law interface 567
 - electric currents 292
 - electrochemistry interfaces 196
 - electrode, shell 223
 - electrostatics 274
 - free and porous media flow 605
 - surface reactions 457
 - transport of concentrated species 397
 - transport of diluted species 343, 449
 - boundary stress (node) 557
 - Brinkman equations 674
 - Brinkman equations interface 617
 - theory 674
 - bulk node 314
 - Butler-Volmer and Tafel expressions
 - tertiary current distribution 186
 - Butler-Volmer equation 49
 - electroanalysis 266
 - electrode kinetics 239
 - secondary current distribution 232
- C**
 - capacitor (node) 307

CAPE-OPEN compliant packages 699
 cathodes 40
 cathodic charge transfer coefficient 233
 cathodic Tafel equation 242
 CFL number
 settings 541, 620
 change cross-section (node) 287
 change thickness (out-of-plane) (node)
 288
 charge conservation (node) 276
 charge conservation, piezoelectric
 (node) 288
 charge discharge cycling (node) 220
 charge relaxation theory 321
 charge transfer reaction 232
 charge transfer reactions 206
 checklist, for modeling 61
 chemical equilibrium 426
 chronoamperometry 261
 circuit import, SPICE 319
 collector node 313
 common settings 31
 concentration (node)
 battery interfaces 132
 transport of diluted species 354
 conduction loss (time-harmonic) (node)
 278
 contact impedance (node) 299
 contributing velocity (node)
 Darcy's law 585
 convection 491
 convective terms, diluted species 483
 coulometry 261
 coupling, to the electrical circuits inter-
 face 70
 creeping flow (spf) interface 536
 critical point 716
 current (node) 452
 current density (node) 452
 current source (node) 225
 current sources, theory 323
 current-controlled current source
 (node) 310
 current-controlled voltage source
 (node) 310
 cyclic voltammetry 261

D

Darcy velocity 491, 591
 Darcy's law interface 565
 Darcy's law interface theory 663
 Debye length 44
 deforming electrode surface (node) 792
 device models, electrical circuits 328
 diffusion models 392
 diode (node) 316
 diode transistor model 334
 distributed impedance (node) 298
 documentation 32
 domain nodes
 battery interfaces, shared 120
 battery with binary electrolyte 93
 Brinkman equations 620
 Darcy's law 567
 electric currents 292
 electrochemistry interfaces 196
 electrophoretic transport interface
 449
 electrostatics 274
 free and porous media flow 605
 lead-acid battery 97
 transport of concentrated species 397
 transport of diluted species 343
 double layer capacitance (node) 211
 drain node 314

E

edge electrode (node) 183
 edge nodes
 battery interfaces 120

- Darcy's law interface 567
- electric currents 292
- electrochemistry interfaces 196
- electrode, shell 223
- electrostatics 274
- surface reactions 457
- electric currents interface 290
 - theory 325
- electric displacement field (node) 282
- electric fields theory 321
- electric insulation (node)
 - electrode, shell 226
- electric potential 135
- electric potential (node) 280
 - electrode, shell 227
- electric reference potential (node) 220
- electrical circuit interface 304
 - theory 327
- electrical circuits
 - modeling techniques 69
- electroanalysis interface 228
 - theory 261
- electroanalysis, definition 261
- electrochemical cells 40
- electrochemical impedance spectroscopy (EIS) 261
- electrochemical sensing 261
- electrode 231
- electrode (node)
 - electrochemistry 198
 - electrode, shell 224
- electrode current (node) 216
- electrode current density (node) 216
- electrode current source (node) 198
- electrode line current source (node) 184
- electrode points current source (node)
 - 185
- electrode potential (node) 218
- electrode power (node) 217
- electrode reaction (node)
 - battery interfaces 84
 - electrochemistry 206
- electrode surface (node) 201
- electrode symmetry axis current source
 - (node) 184
- electrode, shell interface 222
 - theory 259
- electrode-electrolyte boundary interface
 - (node)
 - current distribution 214
- electrode-electrolyte interface coupling
 - (node)
 - free and porous media flow 588, 611
 - transport of diluted species 365, 406
- electrode-electrolyte interfaces 40
- electrodes 39
- electrolysis 39
- electrolyte 231
- electrolyte (node)
 - battery interfaces 121
 - primary and secondary current distribution 179
 - tertiary current distribution 191
- electrolyte current (node) 213
- electrolyte current density (node) 213
- electrolyte current source (node) 199
- electrolyte line current source (node)
 - 184
- electrolyte points current source (node)
 - 185
- electrolyte potential 234
- electrolyte potential (node) 212
- electrolyte symmetry axis current
 - source (node) 185
- electrolyte-electrode domain interface
 - (node) 212

- electrolytes 39
 - electrolytes, salt concentration 135
 - electromagnetic heat source (multiphysics coupling) 794
 - electroneutrality 44
 - electrophoretic transport interface 443
 - electrostatics interface 272
 - theory 321
 - elevation 587
 - emailing COMSOL 33
 - emitter node 313
 - EnthalpyF 716
 - EntropyF 716
 - equation of continuity 321
 - equilibrium potential 232
 - Equilibrium Reaction
 - theory for 481
 - equilibrium reaction (node) 361, 417
 - equilibrium reaction group (node) 438
 - error message, electrical circuits 69
 - exporting
 - SPICE netlists 74
 - external I vs. U (node) 316
 - external I-terminal (node) 318
 - external short circuit (node) 218
 - external surface charge accumulation (node) 281
 - external thermodynamic packages 699
 - external U vs. I (node) 317
 - extra dimensions 79, 89
- F**
- faradaic current 53
 - Faraday's constant 233
 - Faraday's law 488
 - Faraday's laws of electrolysis 265
 - Fick diffusion laws 263
 - Fick equations and diffusivities 503
 - Fick's law approximation diffusion 510
 - Fick's law diffusion model 393
- flash calculation
 - retrograde solution type 716
 - solution type 716–717
- flash calculations 714
 - flow continuity (node) 561
 - flow rate in SCCMs 552
 - fluid flow
 - Brinkman equations theory 674
 - fluid properties (node) 606
 - flux (node) 386, 454
 - battery interfaces 132
 - transport of concentrated species 411
 - transport of diluted species 354, 386, 454
 - flux discontinuity (node) 356
 - Darcy's law 593
 - transport of concentrated species 416
 - transport of diluted species 356
 - fracture flow (node) 598
 - free and porous media flow interface 603
 - theory 670
 - Freundlich exponent 497
 - fully developed flow 552
- G**
- galvanic cells 39
 - gas constant 530
 - gas diffusion 503
 - gas reacting fluids 421, 433
 - gate node 314
 - Gauss' law and charge relaxation theory 321
 - Gauss' law equation 323
 - general stress (boundary stress condition) 557
 - Gibbs free energy 431
 - gravity 564
 - ground (node) 226, 279
 - ground node (node) 305
- H**
- harmonic perturbation (node) 217

- heterogeneous rate constant 266
- hydraulic head (node) 595
- Hygroscopic Swelling 375
- I**
 - importing
 - SPICE netlists 73, 319
 - inductor (node) 307
 - inflow (node) 353, 455
 - transport of concentrated species 412
 - initial cell charge distribution (node) 133
 - initial values (node)
 - battery with binary electrolyte 93
 - Brinkman equations 625
 - corroding electrode surface node 219
 - Darcy's law 586
 - depositing electrode surface node 219
 - electric currents 296
 - electrode, shell 225
 - electrostatics 278
 - free and porous media flow 610
 - lead-acid battery 98
 - lithium-ion battery 83
 - primary and secondary current distribution 180
 - single-phase, laminar flow 545
 - spf interfaces 545
 - surface reactions 459
 - tertiary current distribution 193
 - transport of concentrated species 409
 - transport of diluted species 350
 - inlet (node) 549
 - single-phase flow 549
 - insulation (node) 200, 453
 - intercalating species 123
 - intercalation diffusivity 125
 - internet resources 31
 - intrinsic volume averages 674
 - irreversible reaction 426
- K** Kirchhoff's circuit laws 327
- knowledge base, COMSOL 34
- Knudsen diffusion 405
- L**
 - laminar flow interface 537
 - Langmuir constant 497
 - lead-acid battery interface 95
 - theory 152
 - leaking wall, wall boundary condition
 - 547, 612
 - line charge (node) 284
 - line charge (on axis) (node) 285
 - line charge (out-of-plane) (node) 285
 - line current source (node) 302
 - line current source (on axis) (node) 302
 - line mass source (node)
 - fluid flow 563
 - species transport 359
 - line source
 - species transport 485
 - liquid reacting fluids 421, 433
 - lithium-ion battery interface 79
 - theory 135
 - local
 - CFL number 541, 620
- M**
 - mass action law, laminar flow 529
 - mass based concentrations (node) 350
 - mass fraction (node) 410
 - mass source (node)
 - Brinkman equations 624
 - Darcy's law 584
 - mass transport 502
 - Maxwell's equations
 - electrical circuits and 327
 - Maxwell–Stefan diffusion model 392
 - Maxwell–Stefan diffusivity matrix 506
 - mixture-averaged diffusion model 393, 507
 - modeling checklist 61
 - monolayer adsorption 520

- MPH-files 32
- multicomponent diffusion 505
- multiphase flash calculations 700
- multiphysics couplings
 - electromagnetic heat source (node) 794
- mutual inductance (node) 314
- N**
 - n-Channel MOS transistor 313, 331
 - n-Channel MOSFET (node) 313
 - negative electrode selection (node) 134
 - negative porous electrode (node) 99
 - Nernst equation 266
 - Nernst–Einstein relation 348, 367, 371, 487
 - Nernst–Planck equations 43, 229
 - Nernst–Planck–Poisson equations 44
 - Nernst–Planck–Poisson Equations interface 441
 - netlists, SPICE 73, 319
 - no flow (node) 592
 - no flux (node) 352
 - battery interfaces 132
 - transport of concentrated species 413
 - no slip, wall boundary condition 546, 612
 - no viscous stress (open boundary) 557
 - nodes, common settings 31
 - nonconservative formulations 483
 - nondeforming boundary (node) 793
 - nonfaradaic reactions 130
 - non-faradaic reactions (node) 219
 - normal current density (node) 226
 - normal stress, normal flow (boundary stress condition) 558
 - NPN bipolar junction transistor 328
 - NPN BJT (node) 313
- O**
 - Ohm's law 176, 231, 488
 - Ohm's law and charge relaxation theory 321
- ohmic drop 262
- open boundary (node)
 - single-phase flow 556
 - spf interfaces 556
 - transport of concentrated species 417
 - transport of diluted species 360
- outflow (node)
 - electrophoretic transport 455
 - transport of concentrated species 415
 - transport of diluted species 353
- outlet (node) 553
 - single-phase flow 553
 - spf interfaces 553
- overpotential 48, 232
- P**
 - pair contact impedance (node) 299
 - pair nodes
 - battery interfaces 120
 - Brinkman equations 620
 - Darcy's law interface 567
 - electric currents 292
 - electrochemistry interfaces 196
 - electrode, shell 223
 - electrophoretic transport interface 449
 - electrostatics 274
 - free and porous media flow 605
 - surface reactions 457
 - transport of concentrated species 397
 - transport of diluted species 343
 - partially saturated porous media (node) 369
 - particle intercalation 123
 - p-Channel MOS transistor 313
 - p-Channel MOSFET (node) 313
 - periodic condition (node) 182
 - transport of diluted species 357
 - periodic flow condition (node) 559
 - permeability models 573, 581, 602

- persistence
 - of thermodynamic packages 703
 - pervious layer (node) 596
 - physics interfaces, common settings 31
 - PNP BJT (node) 313
 - point charge (node) 286
 - point charge (on axis) (node) 287
 - point current source (node) 302
 - point current source (on axis) (node) 303
 - point mass source (node)
 - fluid flow 563
 - species transport 359
 - point nodes
 - battery interfaces 120
 - Brinkman equations 620
 - Darcy's law interface 567
 - electric currents 292
 - electrochemistry interfaces 196
 - electrode, shell 223
 - electrostatics 274
 - free and porous media flow 605
 - surface reactions 457
 - transport of diluted species 343
 - point source
 - species transport 484
 - porous conductive binder (node) 130
 - porous electrode (node) 180, 192
 - battery interfaces 123
 - porous electrode coupling (node) 363
 - free and porous media flow 588, 610
 - porous electrode reaction (node) 128, 199
 - porous electrodes 138, 179, 232
 - porous matrix adsorption/desorption reaction (node) 94
 - porous matrix double layer capacitance (node) 200
 - porous media and subsurface flow
 - Brinkman equations interface 617
 - Darcy's law interface 565
 - free and porous media flow interface 603
 - theory, Brinkman equations 674
 - theory, free and porous media flow 670
 - porous media transport properties (node) 365, 369, 402
 - Porous Medium (node)
 - Brinkman equations 607, 621
 - positive porous electrode (node) 99
 - potential (node) 453
 - potentiometry 261
 - potentiostat 269
 - predefined couplings, electrical circuits 70
 - pressure (node) 588, 591, 593
 - pressure head (node) 595
 - pressure point constraint (node) 562
 - primary current distribution 41
 - primary current distribution interface 176
 - theory 229
 - pseudo time step 527
 - pseudo time stepping
 - settings 541, 620

Q quiescent binary electrolytes

 - battery with binary electrolyte interface 146
 - lithium-ion battery interface 135

R reacting fluids, gases and liquids 421, 433

 - Reacting Volume 351, 388
 - reaction (node) 425
 - reaction coefficients (node) 364
 - reaction source (node) 129
 - reaction thermodynamics (node) 439

- reactions (node)
 - surface reactions 459
 - tertiary current distribution 193
 - transport of concentrated species 409
 - transport of diluted species 351
- reference electrode (node) 219
- reservoir (node) 98
- resistive film 150, 238
- resistor (node) 306
- retardation factor 497
- reversible reaction 426
- reversible reaction group (node) 436
- Reynolds number 466
- S**
 - SCCM, flow rate in 552
 - secondary current distribution 41
 - secondary current distribution interface
 - 176
 - theory 229
 - sector symmetry (node) 300
 - SEI 125, 132
 - SEMI standard E12-0303 551
 - semiconductor device models 328
 - separator (node)
 - battery with binary electrolyte interface 122
 - current distribution 193
 - lead battery interface 100
 - single-phase flow interface
 - laminar flow 537
 - sliding wall 548
 - slip, wall boundary condition 547, 612
 - solid electrolyte interface 125, 132
 - solid-electrolyte interface, SEI 150
 - Soret effect 511
 - source node 314
 - space charge density (node) 279
 - species (node) 431
 - species activity (node) 439
 - species group (node) 439
 - species source (node) 453
 - species thermodynamics (node) 440
 - SPICE
 - exporting 74
 - SPICE netlists 73, 319
 - standard cubic centimeters per minute
 - 552
 - standard flow rate 552
 - standard settings 31
 - stoichiometric coefficients 148, 431
 - Stokes equations 536
 - Stokes flow 536
 - stratified porous media 495
 - subcircuit definition (node) 312
 - subcircuit instance (node) 312
 - superficial volume average, porous media 674
 - superficial volume averages, porous media 491
 - supporting electrolyte 261
 - Supporting Electrolytes 487
 - surface charge density (node) 280
 - surface concentration (node) 460
 - surface equilibrium reaction (node) 363, 418
 - surface properties (node) 458
 - surface reactions interface 456
 - theory 519
 - switch (node) 311
 - symmetry (node) 555
 - Darcy's law 592
 - electrochemistry 200
 - spf interfaces 555
 - transport of concentrated species 416
 - transport of diluted species 356
 - symmetry plane (node) 281
- T**
 - Tafel equation 242

Tafel law 49

technical support, COMSOL 33

tertiary current distribution 41

tertiary current distribution interface theory 229

tertiary current distribution, Nernst–Planck interface 186

theory

- battery with binary electrolyte 146
- Brinkman equations 674
- electric currents interface 325
- electric fields 321
- electrical circuit interface 327
- electroanalysis interface 261
- electrode, shell interface 259
- electrostatics interface 321
- free and porous media flow 670
- lead-acid battery 152
- lithium-ion battery 135
- primary current distribution interface 229
- secondary current distribution interface 229
- surface reactions 519
- tertiary current distribution interface 229
- transport of concentrated species interface 502
- transport of diluted species in porous media interface 480
- transport of diluted species interface 479

thermal diffusion 511

thermodynamics package 699

- adding 700

thickness

- fracture 378
- out-of-plane 587

thin diffusion barrier (node) 360

Thin Impermeable Barrier 361

thin low permittivity gap (node) 284

tortuosity factors 493

traction boundary conditions 557

transference number 121

transformer (node) 314

transport mechanisms 399, 405

transport number 121, 146

transport of concentrated species in porous media interface 396

transport of concentrated species interface 390

- theory 502

transport of diluted species in porous media interface 342

- theory 480

transport of diluted species interface 338, 380

- theory 479

turbulent Prandtl number 466

V voltage source (node) 307

voltage-controlled current source (node) 310

voltage-controlled voltage source (node) 309

voltammetry, cyclic 261

voltmeter (node) 306

volume averages 674

volume force (node) 545, 625

- free and porous media flow 609
- spf interfaces 545

W wall (node)

- free and porous media flow 611
- single-phase flow 546

websites, COMSOL 34

Z zero charge (node) 279

