

INTRODUCTION TO AC/DC Module

Introduction to the AC/DC Module

© 1998–2023 COMSOL

Protected by patents listed on www.comsol.com/patents, or see Help>About COMSOL Multiphysics on the File menu in the COMSOL Desktop for less detailed lists of U.S. Patents that may apply. Patents pending.

This Documentation and the Programs described herein are furnished under the COMSOL Software License Agreement (www.comsol.com/sla) and may be used or copied only under the terms of the license agreement.

COMSOL, the COMSOL logo, COMSOL Multiphysics, COMSOL Desktop, COMSOL Compiler, COMSOL Server, and LiveLink are either registered trademarks or trademarks of COMSOL AB. All other trademarks are the property of their respective owners, and COMSOL AB and its subsidiaries and products are not affiliated with, endorsed by, sponsored by, or supported by those trademark owners. For a list of such trademark owners, see www.comsol.com/trademarks.

Version: COMSOL 6.2

Contact Information

Visit the Contact COMSOL page at www.comsol.com/contact to submit general inquiries or search for an address and phone number. You can also visit the Worldwide Sales Offices page at www.comsol.com/contact/offices for address and contact information.

If you need to contact Support, an online request form is located on the COMSOL Access page at www.comsol.com/support/case. Other useful links include:

- Support Center: www.comsol.com/support
- Product Download: www.comsol.com/product-download
- Product Updates: www.comsol.com/product-update
- COMSOL Blog: www.comsol.com/blogs
- Discussion Forum: www.comsol.com/forum
- Events: www.comsol.com/events
- COMSOL Video Gallery: www.comsol.com/videos
- Support Knowledge Base: www.comsol.com/support/knowledgebase

Part number: CM020104

Introduction	5
The Use of the AC/DC Module.	6
The AC/DC Module Physics Interfaces.	10
Physics Interface Guide by Space Dimension and Study Type . . .	18
Tutorial 1: Evaluating the Performance of an Insulator	24
Tutorial 2: Computing the Impedance of a 3D Inductor	37
Tutorial 3: Electrical Heating in a Busbar.	68

Introduction

The AC/DC Module is used by engineers and scientists to understand, predict, and design electric and magnetic fields in static, low-frequency, and transient applications. Simulations of this kind result in more powerful and efficient products and engineering methods. The module allows its users to quickly and accurately predict electromagnetic field distributions, electromagnetic forces, and power dissipation in a proposed design. Compared to traditional prototyping, COMSOL Multiphysics helps to lower costs and can evaluate and predict entities that are not directly measurable in experiments. It also allows the exploration of operating conditions that would destroy a real prototype or be hazardous.

The AC/DC Module includes stationary and dynamic electric and magnetic fields in two-dimensional and three-dimensional spaces along with traditional circuit-based modeling of passive and active devices. All modeling formulations are based on Maxwell's equations or subsets and special cases of these, together with various constitutive relations and material models. The modeling capabilities are accessed via a number of predefined physics interfaces, referred to as AC/DC interfaces, which allow you to set up and solve electromagnetic models. The AC/DC interfaces cover electrostatics, DC current flow, magnetostatics, AC and transient current flow, AC and transient magnetodynamics, and AC electromagnetic (full Maxwell) formulations.

Under the hood, the majority of the AC/DC interfaces formulate and solve the differential form of Maxwell's equations together with initial and boundary conditions. The equations are solved using the finite element method with numerically stable element discretization in combination with state-of-the-art algorithms for preconditioning and solution of the resulting sparse equation systems. Two of the AC/DC interfaces are based on boundary integral formulations of Maxwell's equations and are solved using the boundary element method. The results are presented in the graphics window through predefined plots of electric and magnetic fields, currents, and voltages, or as expressions of the physical quantities that you can define freely, as well as derived tabulated quantities (for example resistance, capacitance, inductance, electromagnetic force, and torque) obtained from a simulation.

The workflow in the module is straightforward and is described by the following steps: define the geometry, select materials, select a suitable AC/DC interface, define boundary and initial conditions, define the finite or boundary element mesh, select a solver, solve the model, and visualize the results. All these steps are accessed from the COMSOL Desktop. The solver selection step is usually carried out automatically using the default settings, which are already tuned for each specific AC/DC interface.

The AC/DC Module application library describes the available features using tutorial and benchmark examples for the different formulations. The library contains models for industrial equipment and devices, tutorial models, and benchmark models for verification and validation of the AC/DC interfaces.

This guide will give you a jump start to your modeling work. It has examples of the typical use of the module, a list of all the AC/DC interfaces including a short description of each, and three tutorial models that introduce the modeling workflow. The appended models, [Tutorial 1: Evaluating the Performance of an Insulator](#), [Tutorial 2: Computing the Impedance of a 3D Inductor](#), and [Tutorial 3: Electrical Heating in a Busbar](#) are examples of modeling capacitive, inductive, and resistive devices, respectively.

The Use of the AC/DC Module

The AC/DC Module can model electric, magnetic, and electromagnetic fields in static and low-frequency applications. The latter means that it covers the modeling of devices that are up to about 0.1 electromagnetic wavelengths in size. Thus, it can be used to model nanodevices up to optical frequencies, or human size devices operated at frequencies up to 10 MHz.

AC/DC simulations are frequently used to extract circuit parameters. [Figure 1](#) on the next page shows the electric potential and the magnetic flux lines for a microscale square inductor, used for LC bandpass filters in microelectromechanical systems (MEMS). A DC voltage is applied across the electrically conducting square shaped spiral, resulting in an electric current flow that in turn generates a magnetic field through and around the device.

The distribution and strength of electric and magnetic fields arising from applied current and voltage can be translated into resistance, capacitance, and inductance values for an equivalent circuit model that is easy to understand and analyze from both qualitative and quantitative perspectives. This kind of understanding in terms of a simplified model is usually the first step when creating or improving a design. Another common use of this module is to predict forces and motion in electric motors and actuators of a wide range of scales.

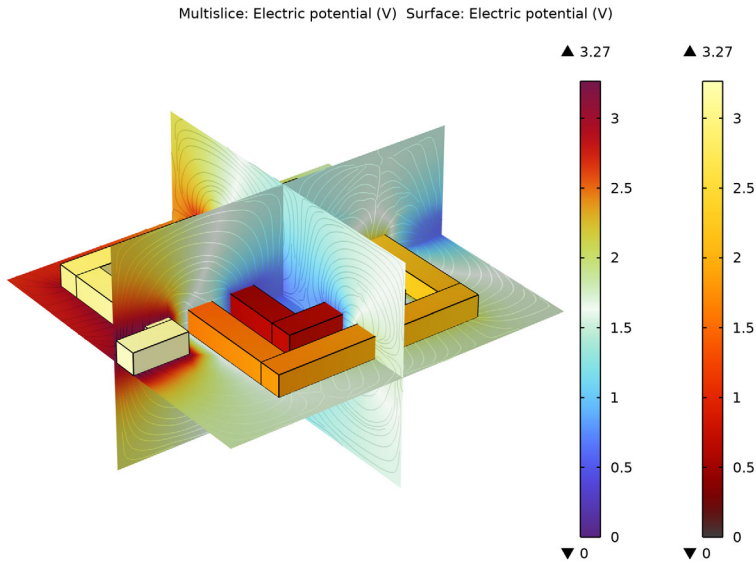

Figure 1: Electric potential distribution and magnetic flux lines for a MEMS inductor.

In [Figure 2](#), [Figure 3](#), and [Figure 4](#), the dynamics of a magnetic brake is shown. The brake consists of a disc of conductive material and a permanent magnet. The magnet generates a constant magnetic field, in which the disc is rotating. When a conductor moves in a magnetic field it induces currents, and the Lorentz forces from the currents counteracts the spinning of the disc.

The braking torque is computed from the magnetic flux and eddy current distributions. It is then fed into a rigid body model for the dynamics of the spinning disc that is solved simultaneously with the electromagnetic model.

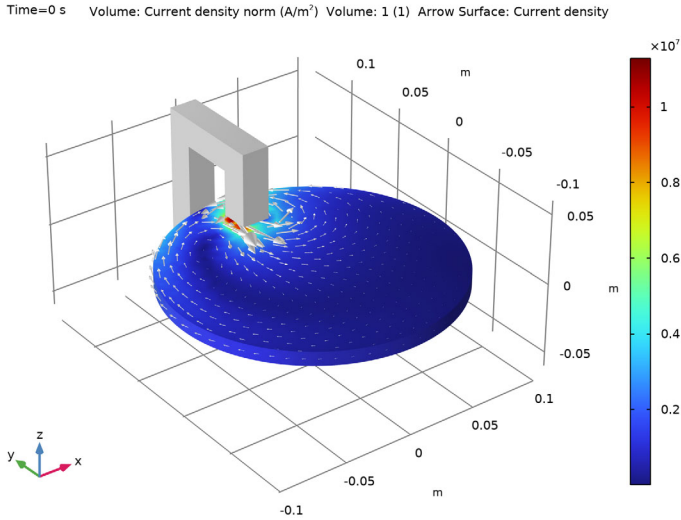

Figure 2: The eddy current magnitude and direction in the spinning disc of a magnetic brake.

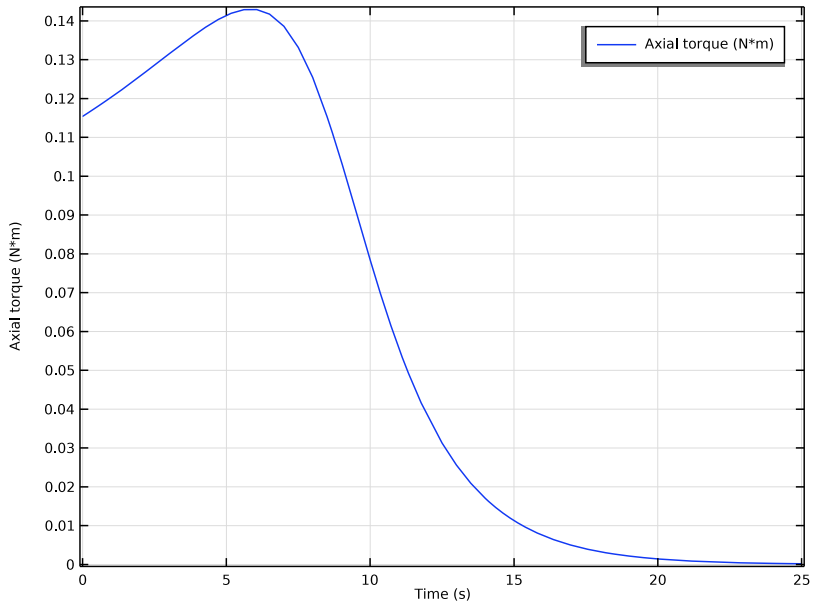

Figure 3: The time evolution of the braking torque.

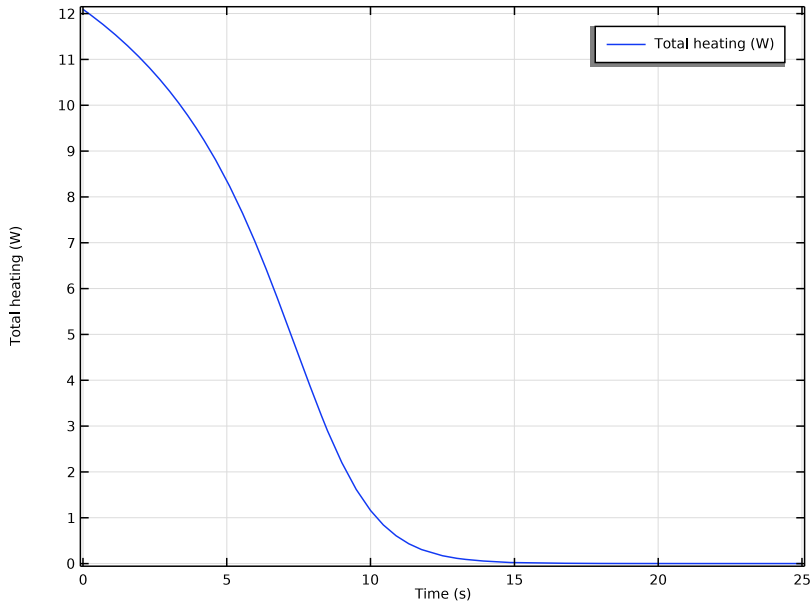

Figure 4: The time evolution of the dissipated power.

The AC/DC Module includes a range of tools to evaluate and export results, for example, the evaluation of force, torque, as well as lumped circuit parameters like resistance, capacitance, inductance, impedance, and scattering matrices (S-parameters). Lumped parameters can also be exported in the Touchstone file format.

The combination of fully distributed electromagnetic field modeling and simplified circuit-based modeling is an ideal basis for design, exploration, and optimization. More complex system models can be exploited using circuit-based modeling while maintaining links to full field models for key devices in the circuit. In this way, the combination allows for design innovation and optimization on both levels.

The AC/DC Module Physics Interfaces

The AC/DC interfaces are based on Maxwell's equations, or subsets and special cases of these, together with material models. Different subsets of Maxwell's equations in combination with special material models result in different electric, magnetic, or electromagnetic formulations. In the module, these laws of physics are translated by the AC/DC interfaces to sets of partial differential equations or integral equations with corresponding initial and boundary conditions.

An AC/DC interface defines a number of features. Each feature represents a term or condition in the underlying Maxwell-based formulation and may be defined in a geometric entity of the model, such as a domain, boundary, edge (for 3D components), or point.

[Figure 5](#) on the next page shows the Model Builder window and the Settings window for the selected Charge Conservation 1 feature node in the Electrostatics interface. The Charge Conservation 1 node adds the terms representing Electrostatics to the model equations for a selected geometrical domain in the model.

Furthermore, the Charge Conservation 1 node may link to the Materials node to obtain physical properties, in this case the relative permittivity of a user-defined dielectric. The properties, defined by the Dielectric material node, may be functions of the modeled physical quantities, such as temperature. The Zero

Charge 1 boundary condition feature adds the natural boundary conditions that limit the Electrostatics domain.

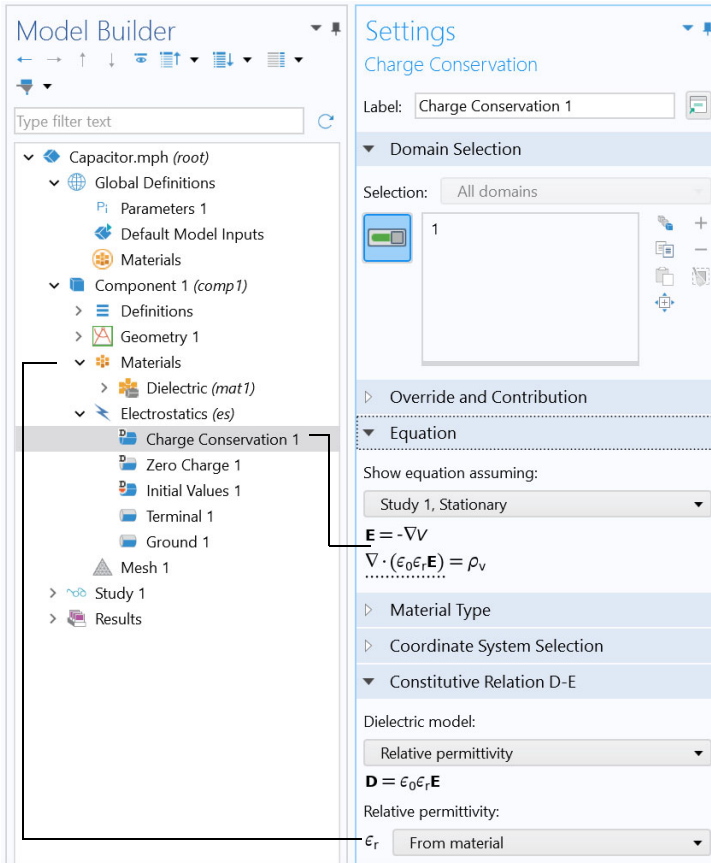



Figure 5: The Model Builder window (to the left), and the Settings window for Charge Conservation 1 for the selected feature node (to the right). The Equation section in the Settings window shows the model equations and the terms added to the model equations by the Charge Conservation 1 node. The added terms are underlined with a dotted line. The text also explains the link between the material properties represented by the Dielectric node and the values for the Relative permittivity.

The AC/DC Module has several AC/DC interfaces () for different types of electric and magnetic modeling. Figure 6 shows the AC/DC interfaces as well as predefined multiphysics combinations of more than one physics interface, some of which require additional licenses. Also see [Physics Interface Guide by Space Dimension and Study Type](#).

- AC/DC
 - Electric Fields and Currents
 - Electrostatics (es)
 - Electrostatics, Boundary Elements (esbe)
 - Electric Currents (ec)
 - Magnetic Fields, No Currents
 - Magnetic Fields, No Currents (mfnf)
 - Magnetic Fields, No Currents, Boundary Elements (mfnfcb)
 - Electromagnetic Fields
 - Magnetic Fields (mf)
 - Vector Formulations
 - Magnetic and Electric Fields (mef)
 - Magnetic Field Formulation (mfh)
 - Electromagnetic Heating
 - Joule Heating
 - Joule Heating and Thermal Expansion
 - Induction Heating
 - Pyroelectricity
 - Electromagnetics and Mechanics
 - Rotating Machinery, Magnetic (rmm)
 - Rotating Machinery, Magnetic-Structure Interaction
 - Magnetic-Elastic Interaction in Rotating Machinery
 - Magnetic-Rigid Body Interaction in Rotating Machinery
 - Magnetic Machinery, Rotating, Time Periodic (mmtp)
 - Electromechanics
 - Electromechanics
 - Electromechanics, Boundary Elements
 - Piezoelectricity
 - Piezoelectricity, Solid
 - Piezoelectricity and Pyroelectricity
 - Electrostriction
 - Ferroelectroelasticity
 - Magnetostriction
 - Piezomagnetism
 - Nonlinear Magnetostriction
 - Magnetomechanics
 - Magnetomechanics
 - Magnetomechanics, No Currents
 - Electromagnetics and Fluids
 - Magnetohydrodynamics, Out-of-Plane Currents
 - Magnetohydrodynamics, In-Plane Currents
 - Particle Tracing
 - Charged Particle Tracing (cpt)
 - Particle-Field Interaction, Nonrelativistic
 - Particle-Field Interaction, Relativistic
 - Electrical Circuit (cir)
- AC/DC
 - Electric Fields and Currents
 - Electrostatics (es)
 - Electrostatics, Boundary Elements (esbe)
 - Electric Currents (ec)
 - Magnetic Fields, No Currents
 - Magnetic Fields, No Currents (mfnf)
 - Magnetic Fields, No Currents, Boundary Elements (mfnfcb)
 - Electromagnetic Fields
 - Magnetic Fields (mf)
 - Vector Formulations
 - Magnetic and Electric Fields (mef)
 - Magnetic Field Formulation (mfh)
 - Electromagnetic Heating
 - Joule Heating
 - Induction Heating
 - Electromagnetics and Mechanics
 - Rotating Machinery, Magnetic (rmm)
 - Magnetic Machinery, Rotating, Time Periodic (mmtp)
 - Electromagnetics and Fluids
 - Magnetohydrodynamics, Out-of-Plane Currents
 - Magnetohydrodynamics, In-Plane Currents
 - Electrical Circuit (cir)

Figure 6: The AC/DC Module physics interfaces as displayed in the Model Wizard. The left column lists all physics interfaces under the AC/DC branch, some of which requires additional licenses such as the Structural Mechanics Module. The right column displays the available physics interfaces with the AC/DC Module license only.

As shown in Figure 6, the physics interfaces available under the AC/DC branch are categorized into different subbranches. A brief overview of different branches and physics interfaces follows.

ELECTRIC FIELDS AND CURRENTS

The Electric Fields and Currents branch () contains physics interfaces for analyzing electric fields, electric potential distributions, charge densities and current conservation at relatively low frequencies. Inductive effects are negligible; that is, the skin depth and wavelength are considered to be much larger than the studied device.

The Electrostatics interface () solves a charge conservation equation for the electric potential given the spatial distribution of the electric charge. It is used primarily to model charge conservation in dielectrics under static conditions. This physics interface applies also under transient conditions but then it is usually combined with a separate transport model for single species or multispecies charge transport. Such transport models can be found in the Chemical Reaction Engineering Module and in the Plasma Module. Some typical applications that are simulated in the Electrostatics interface are capacitors, dielectric sensors, and bushings for high voltage DC insulation.

The Electrostatics, Boundary Elements interface () solves Laplace's equation for the scalar electric potential. It is used for computing the potential distribution in dielectrics with constant and isotropic electrical permittivity under conditions where the electric potential distribution on the boundaries is explicitly prescribed. The formulation is based on the boundary element method and the interface is available in 2D and 3D. It can be coupled to the Electrostatics interface to combine the modeling of large open regions (using the boundary element method) and the modeling of complex inhomogeneous and anisotropic dielectrics (using the finite element method).

The Electric Currents interface () is used to model DC, AC, and transient electric current flow in conductive and capacitive media. This physics interface solves a current conservation equation for the electric potential. Some examples of its use are designing busbars for DC current distribution and designing AC capacitors.

The Electric Currents in Shells interface () is available in 3D geometries. It applies to faces in 3D where it is used to model DC electric current flow confined to thin current-conducting shells of fixed or varying thickness. This physics interface solves a boundary current conservation equation for the electric potential. Modeling ground return current flow in the hull of a ship or in the body of a car are examples of simulations that can be done with this physics interface. It is the same interface as the Electric Currents in Layered Shells interface but with different settings (for single shell).

The Electric Currents in Layered Shells interface () is available in 3D geometries. It applies to faces in 3D where it is used to model DC electric current flow confined to thin current-conducting layered shells of fixed or varying

thickness. This physics interface solves a boundary current conservation equation for the electric potential. It is the same interface as the Electric Currents in Shells interface but with different settings (for layered shells).

MAGNETIC FIELDS, NO CURRENTS

The Magnetic Fields, No Currents branch () contains physics interfaces for analyzing magnetostatic fields from permanent magnets and other current free magnetic sources. The formulation used in the contained interfaces is stationary, but for use together with other physics, time-domain modeling is also supported in 2D and 3D.



The Magnetic Fields, No Currents interface () is used to efficiently model magnetostatics in current free regions, for example, when designing permanent magnet-based devices. It solves a magnetic flux conservation equation for the magnetic scalar potential. This physics interface supports both linear media, media with magnetic saturation and time-domain hysteresis.

The Magnetic Fields, No Currents, Boundary Elements interface () solves Laplace's equation for the scalar magnetic potential. It is used to compute magnetostatic fields from permanent magnets and other current free magnetic sources in media with constant and isotropic magnetic permeability. The formulation is based on the boundary element method and the interface is available in 2D and 3D. It can be coupled to the Magnetic Fields, No Currents Interface and the Magnetic Fields Interface to combine the modeling of large open, current free regions (using the boundary element method) and the modeling of complex inhomogeneous and anisotropic magnetic media (using the finite element method).

ELECTROMAGNETIC FIELDS

The Electromagnetic Fields branch () contains a variety of physics interfaces used for situations where there is a unidirectional or bidirectional coupling between electric and magnetic fields. Generally speaking, wave phenomena are not considered (although some interfaces support them), but inductive effects are. In other words, these interfaces are typically used when the skin depth can be of the order of the device size, but the wavelength is still much larger.

The Magnetic Fields interface () solves Ampère's law for the magnetic vector potential. It is used to model magnetostatics, AC, and transient magnetodynamics. Magnets, magnetic actuators, electric motors, transformers, induction based nondestructive testing, and eddy current generation are typical applications for this physics interface. It supports both linear media, media with magnetic saturation and time-domain hysteresis.

The Vector Formulations branch () contains a variety of physics interfaces used for situations where there is a unidirectional or bidirectional coupling between electric and magnetic fields. Generally speaking, wave phenomena are not considered (although some interfaces support them), but inductive effects are. In other words, these interfaces are typically used when the skin depth can be of the order of the device size, but the wavelength is still much larger. As opposed to the other interfaces in the Electromagnetic Fields branch (), the interfaces in this subcategory typically require a bit more expertise when using, and are not recommended as a starting point. In some cases they are more effective, or they can handle some special case that the default recommended option cannot handle. The default option in this case is the Magnetic Fields interface.

The Magnetic and Electric Fields interface () is used to model magnetostatics and magnetodynamics. It solves Ampère's law for the magnetic vector potential together with a current conservation equation for the electric potential. The application areas are mostly the same as for the Magnetic Fields interface. Note that in most cases, using the Magnetic Fields interface with its dedicated coil modeling feature, is the preferred choice over using the Magnetic and Electric Fields interface.

The Magnetic Field Formulation interface () solves Faraday's law for the magnetic \mathbf{H} -field. It is used to model mainly AC, and transient magnetodynamics in conducting domains. It is especially suitable for modeling involving nonlinear conductivity effects, for example in superconductors.

The Magnetic Fields, Currents Only interface () is used to compute magnetic fields from currents under the assumption that all regions have a uniform relative magnetic permeability of one. It is designed to support both solenoidal and non-solenoidal. It returns the value of the Biot-Savart integral in free space.

ELECTROMAGNETIC HEATING

The Electromagnetic Heating branch () includes multiphysics interfaces that combine electromagnetics with heat transfer or heat transfer and structural mechanics.

The Joule Heating interface () combines all features from the Electric Currents interface with the Heat Transfer interface to model resistive heating and heating due to dielectric losses. The predefined multiphysics couplings add the electromagnetic power dissipation as a heat source, and the electromagnetic material properties can depend on the temperature.

The Joule Heating and Thermal Expansion multiphysics interface () combines thermal, electric, and structural multiphysics effects. The predefined interaction adds the electromagnetic losses from the electric field as a heat source. In addition, the temperature from the Heat Transfer in Solids interface acts as a thermal load

for the Solid Mechanics interface, causing thermal expansion. It requires the Structural Mechanics Module license.

The Induction Heating interface () combines all features from the Magnetic Fields interface in the time-harmonic formulation with the Heat Transfer interface to model induction and eddy current heating. The predefined multiphysics couplings add the electromagnetic power dissipation as a heat source, and the electromagnetic material properties can depend on the temperature. This physics interface is based on the assumption that the magnetic cycle time is short compared to the thermal time scale (adiabatic assumption).

ELECTROMAGNETICS AND MECHANICS

The Electromagnetics and Mechanics branch () contains a variety of physics interfaces typically used for multiphysics scenarios that involve electromagnetics and (structural) mechanics. Common applications include motors, generators, actuators, and sensors. Most of the physics interfaces under this branch requires additional licenses such as the Structural Mechanics Module license and/or the MEMS Module license.

The Rotating Machinery, Magnetic interface () combines the magnetic fields (magnetic vector potential) and magnetic fields, no currents (scalar magnetic potential) formulations with a selection of predefined frames for prescribed rotation or rotation velocity — it shares most of its features with the Magnetic Fields interface. This physics interface requires that the geometry is created as an assembly from individual parts for the rotor and stator.

The Magnetic Machinery, Rotating, Time Periodic interface () solves Maxwell's equations formulated using the out-of-plane magnetic vector potential in 2D in a time periodic way, so that all time frames are solved simultaneously. This physics interface can also be used to model rotating machines, in which case the geometry should be created as an assembly from individually moving parts.

The Electromechanics branch () contains physics interfaces to model electromechanical forces in solids.



The Piezoelectricity branch () contains physics interfaces to model the piezoelectric effects in solids and shells.







The Electrostriction multiphysics interface () combines Solid Mechanics and Electrostatics together with the constitutive relationships required to model electrostrictive effect in the material. Both the direct and inverse effects can be modeled. In contrast to linear piezoelectricity, the electrostrictive strain induced in polarized material is proportional to the square of the polarization.

The Ferroelectroelasticity multiphysics interface () combines Solid Mechanics and Electrostatics together with the constitutive relationships required to model nonlinear ferroelectric materials with polarization saturation and possible

hysteresis. Many piezoelectric material exhibit such nonlinear ferroelectroelastic behavior at large applied electric fields. Both the direct and inverse electrostrictive couplings can be modeled.

The Magnetostriction multiphysics interface () combines Solid Mechanics and Magnetic Fields interfaces together with the constitutive relationships required to analyze magnetostrictive materials and devices. Both the direct Joule effect and inverse Villari effect can be modeled. Linear and nonlinear models of magnetostrictive strain and material magnetization are available.

The Magnetomechanics branch () contains physics interfaces to model magnetomechanical forces in solids. The Magnetomechanics multiphysics interface () combines Solid Mechanics and Magnetic Fields interfaces together with a moving mesh functionality to model the deformation of magnetically actuated structures. The Magnetomechanics, No Currents multiphysics interface () combines Solid Mechanics and Magnetic Fields, No Currents interfaces together with a moving mesh functionality to model the deformation of magnetostatically actuated structures.

The Piezoresistivity branch () contains three physics interfaces to simulate the piezoresistive effect: the Piezoresistivity, Domain Currents interface (), the Piezoresistivity, Boundary Currents interface (), and with the addition of the Structural Mechanics Module, the Piezoresistivity, Shell interface (). The branch also has a legacy interface called Electric Currents, Single Layer Shell (), which has been replaced by the Electric Currents in Shells interface ().

ELECTROMAGNETICS AND FLUIDS

The Electromagnetics and Fluids branch () contains physics interfaces used for multiphysics scenarios that involve electromagnetics and fluid flow such as magnetohydrodynamics.

The Magnetohydrodynamics interfaces () are used to model the interaction between moving conducting fluids and magnetic fields. Two versions of the interface (Out-of-Plane Currents and In-Plane Currents) are available in 2D dimension.

PARTICLE TRACING

The Particle Tracing branch () contains interfaces for computing the trajectories of charged particles in electric and magnetic fields, including unidirectional and bidirectional particle–field interactions. The physics interfaces under this branch requires the Particle Tracing Module license.

The Charged Particle Tracing interface () is used to model charged particle orbits under the influence of electromagnetic forces. In addition, it can also model two-way coupling between the particles and fields. Some typical applications are

particle accelerators, vacuum tubes and ion implanters. The physics interface supports time-domain modeling only in 2D and 3D. The physics interface solves the equation of motion for charged particles subjected to electromagnetic forces.

The Particle–Field Interaction, Nonrelativistic interface () combines the Charged Particle Tracing interface with the Electrostatics interface. The Electric Particle–Field Interaction multiphysics coupling feature is added automatically. The Particle–Field Interaction, Nonrelativistic interface is used to model beams of charged particles at nonrelativistic speeds. The particles generate a space charge density term as they propagate through domains. The space charge density is then used as a source term in the Electrostatics interface, and the resulting electric force on the particles is computed.









The Particle–Field Interaction, Relativistic interface () combines the Charged Particle Tracing, Electrostatics, and Magnetic Fields physics interfaces. The Electric Particle–Field Interaction and Magnetic Particle–Field Interaction multiphysics coupling features are added automatically. The Particle–Field Interaction, Relativistic interface is used to model beams of relativistic charged particles. The particles generate space charge density and current density terms as they propagate through domains. The space charge density and current density are then used to compute electric and magnetic forces, respectively, which are exerted on the particles.

ELECTRICAL CIRCUIT











The Electrical Circuit interface () uses the equations to model electrical circuits with or without connections to a distributed fields model, solving for the voltages, currents, and charges associated with the circuit elements. Circuit models can contain passive elements like resistors, capacitors, and inductors as well as active elements such as diodes and transistors.







Physics Interface Guide by Space Dimension and Study Type







The table lists the physics interfaces available specifically with this module in addition to the COMSOL Multiphysics basic license.

PHYSICS INTERFACE	ICON	TAG	SPACE DIMENSION	AVAILABLE STUDY TYPE
 AC/DC				
Electric Currents ¹		ec	all dimensions	stationary; stationary source sweep; frequency domain; time dependent; small signal analysis, frequency domain; eigenfrequency
Electric Currents in Shells		ecis	3D	stationary; frequency domain; time dependent; eigenfrequency
Electric Currents in Layered Shells		ecis	3D	stationary; frequency domain; time dependent; eigenfrequency
Electrical Circuit		cir	Not space dependent	stationary; frequency domain; time dependent; frequency domain; eigenfrequency
Electrostatics ¹		es	all dimensions	stationary; time dependent; stationary source sweep; eigenfrequency; frequency domain; small signal analysis, frequency domain
Electrostatics, Boundary Elements		esbe	3D, 2D	stationary; stationary source sweep; frequency domain; small signal analysis, frequency domain
Magnetic Fields ¹		mf	3D, 2D, 2D axisymmetric	stationary; frequency domain; time dependent; small signal analysis, frequency domain; coil geometry analysis (3D only); time to frequency losses; eigenfrequency
Magnetic Field Formulation		mfh	3D, 2D, 2D axisymmetric	stationary; frequency domain; time dependent; small signal analysis, frequency domain; time to frequency losses

PHYSICS INTERFACE	ICON	TAG	SPACE DIMENSION	AVAILABLE STUDY TYPE
Magnetic Fields, No Currents		mfnc	3D, 2D, 2D axisymmetric	stationary; frequency domain; time dependent; time to frequency losses
Magnetic Fields, No Currents, Boundary Elements		mfncbe	3D, 2D	stationary
Magnetic Fields, Currents Only		mfco	3D	stationary; stationary source sweep with initialization; frequency domain source sweep with initialization
Magnetic and Electric Fields		mef	3D, 2D, 2D axisymmetric	stationary; frequency domain; time dependent; stationary source sweep; frequency domain source sweep; coil geometry analysis (3D only)
Rotating Machinery, Magnetic		mmm	3D, 2D	stationary; time dependent, coil geometry analysis (3D only); frequency domain; time to frequency losses
Magnetic Machinery, Rotating, Time Periodic		mmtp	2D	stationary; time dependent; frequency domain
Magnetohydrodynamics		—	3D, 2D, 2D axisymmetric	stationary; time dependent; frequency-stationary; frequency-transient
 Particle Tracing				
Particle Field Interaction, Nonrelativistic ⁴		—	3D, 2D, 2D axisymmetric	bidirectionally coupled particle tracing; time dependent
Particle Field Interaction, Relativistic ⁴		—	3D, 2D, 2D axisymmetric	bidirectionally coupled particle tracing; time dependent
Charged Particle Tracing ⁴		cpt	3D, 2D, 2D axisymmetric	bidirectionally coupled particle tracing; time dependent

PHYSICS INTERFACE	ICON	TAG	SPACE DIMENSION	AVAILABLE STUDY TYPE
 Heat Transfer				
 Electromagnetic Heating				
Induction Heating ²		—	3D, 2D, 2D axisymmetric	stationary; time dependent; frequency-stationary; frequency-transient; frequency-stationary, one-way electromagnetic heating; frequency-transient, one-way electromagnetic heating; small-signal analysis; frequency domain
Joule Heating ^{1,2}		—	all dimensions	stationary; time dependent; frequency-transient; small-signal analysis; frequency domain; frequency-stationary; frequency-stationary, one-way electromagnetic heating; frequency-transient, one-way electromagnetic heating
 Structural Mechanics				
 Thermal-Structure Interaction				
Joule Heating and Thermal Expansion ^{2,3}		—	3D, 2D, 2D axisymmetric	stationary; time dependent
 Electromechanics				
Electromechanics ^{2,3}		—	3D, 2D, 2D axisymmetric	stationary; eigenfrequency, prestressed; time dependent; frequency domain, prestressed
Electromechanics, Boundary Elements ^{2,3}		—	3D, 2D	stationary; eigenfrequency, prestressed; time dependent; frequency domain, prestressed

PHYSICS INTERFACE	ICON	TAG	SPACE DIMENSION	AVAILABLE STUDY TYPE
 Piezoelectricity				
Piezoelectricity, Solid ²		—	3D, 2D, 2D axisymmetric	stationary; eigenfrequency; eigenfrequency, prestressed; time dependent; time dependent, modal; frequency domain; frequency domain, modal; frequency domain, prestressed; frequency domain, prestressed, modal; small-signal analysis, frequency domain; linear buckling
Piezoelectricity, Layered Shell ^{2,7}		—	3D	stationary; eigenfrequency; time dependent; frequency domain
 Magnetomechanics				
Piezomagnetism ^{2,3}		—	3D, 2D, 2D axisymmetric	stationary; eigenfrequency; time dependent; frequency domain; small-signal analysis, frequency domain; eigenfrequency, prestressed; frequency domain, prestressed
Nonlinear Magnetostriction ^{2,3}		—	3D, 2D, 2D axisymmetric	stationary; eigenfrequency; time dependent; frequency domain; small-signal analysis, frequency domain; eigenfrequency, prestressed; frequency domain, prestressed
Magnetomechanics ^{2,3}		—	3D, 2D, 2D axisymmetric	stationary; eigenfrequency; time dependent; frequency domain; small-signal analysis, frequency domain; eigenfrequency, prestressed; frequency domain, prestressed

PHYSICS INTERFACE	ICON	TAG	SPACE DIMENSION	AVAILABLE STUDY TYPE
Magnetomechanics, No Currents ^{2,3}		—	3D, 2D, 2D axisymmetric	stationary; eigenfrequency; time dependent; frequency domain; small-signal analysis, frequency domain; eigenfrequency, prestressed; frequency domain, prestressed
Magnetic–Elastic Interaction in Rotating Machinery ^{2,5}		—	3D, 2D	stationary; time dependent; frequency domain;
Magnetic–Rigid Body Interaction in Rotating Machinery ^{2,6}		—	3D, 2D	stationary; time dependent; frequency domain;
 Electrostriction				
Ferroelectroelasticity ^{2,3}		—	3D, 2D, 2D axisymmetric	stationary; time dependent; frequency domain
Electrostriction ^{2,3}		—	3D, 2D, 2D axisymmetric	stationary; time dependent; frequency domain
 Piezoresistivity				
<p>¹ This physics interface is included with the core COMSOL package but has added functionality for this module.</p> <p>² This physics interface is a predefined multiphysics coupling that automatically adds all the physics interfaces and coupling features required.</p> <p>³ Requires the addition of the Structural Mechanics Module or the MEMS Module.</p> <p>⁴ Requires the addition of the Particle Tracing Module.</p> <p>⁵ Requires the addition of the Structural Mechanics Module.</p> <p>⁶ Requires the addition of the Multibody Dynamics Module.</p> <p>⁷ Requires the addition of the Composite Materials Module.</p>				

Tutorial I: Evaluating the Performance of an Insulator

Insulators are widely used in high voltage power transmission lines to support the weight of suspended conductors without allowing the current to flow through the tower to ground. A typical high voltage composite insulator rated at 110 kV is shown in [Figure 7](#).

High voltage insulators are usually made from glass, porcelain, or composite polymer materials. Composite insulators are typically composed of a central rod made of fiber reinforced plastic and an outer weather shed made of silicone rubber. The weather shed makes some parts of the insulator stay dry to withstand the flashover in wet weather.

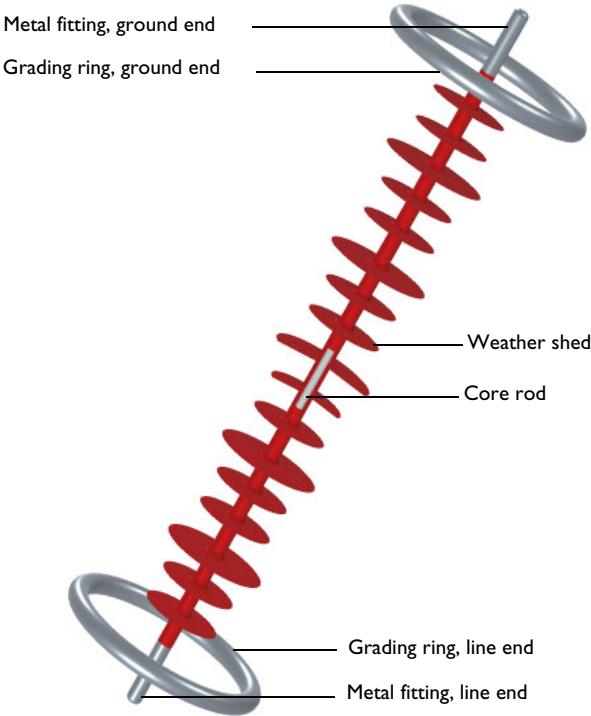

Figure 7: The high voltage insulator geometry.

The electric field is not distributed evenly across the insulator but is strongest at the sheds nearest to both ends, which flashover first under an overvoltage. Metal

grading rings are usually installed around the sheds at both ends, to reduce the nonuniformity of the electric field and increase the flashover voltage.

Under static conditions, the electric potential V is defined by $\mathbf{E} = -\nabla V$. Using this together with the constitutive relation $\mathbf{D} = \epsilon_r \epsilon_0 \mathbf{E}$ and setting the free space charge to zero, one can rewrite Gauss' law as a variant of Poisson's equation

$$-\nabla \cdot (\epsilon_r \epsilon_0 \nabla V) = 0$$



where ϵ_0 is the permittivity of vacuum and ϵ_r the relative permittivity of the material. This equation can be solved by using the Electrostatics interface. To obtain a unique solution, electric boundary conditions are applied to the line end with the overvoltage amplitude $V = 500$ kV and to the ground end with $V = 0$.

The first step is to perform an electrostatic analysis without grading rings.







Model Wizard

Note: These instructions are for the user interface on Windows but apply, with minor differences, also to Linux and Mac.

1 To start the software, double-click the COMSOL icon on the desktop. When the software opens, you can choose to use the Model Wizard to create a new COMSOL Multiphysics model or Blank Model to create one manually. For this tutorial, click the Model Wizard button.

If COMSOL Multiphysics is already open, you can start the Model Wizard by selecting New  from the File menu and then click Model Wizard .

The Model Wizard guides you through the first steps of setting up a model. The next window lets you select the dimension of the modeling space.

- 2 [Figure 7](#) indicates that the geometry of the insulator can be modeled in 2D Axisymmetric Space Dimension. Therefore, in the Space Dimension window click 2D Axisymmetric .
- 3 In the Select Physics tree under AC/DC, expand Electric Fields and Currents  and select Electrostatics (es) .
- 4 Click Add then click Study .
- 5 In the Select Study window under General Studies, click Stationary .
- 6 Click Done .

Global Definitions - Parameters

It is good modeling practice to gather constants and parameters in one place so that you can change them easily. Using parameters will also improve the readability of your input data.

The following parameters will be defined: the overvoltage amplitude V_i , thickness of the grading ring H , diameter of the grading ring D and distance to the grading ring from the end d .

- 1 In the Model Builder Window, under Global Definitions, select Parameters .
- 2 In the Settings window for Parameters, locate the Parameters section. In the table, enter the following settings:



NAME	EXPRESSION	VALUE	DESCRIPTION
V_i	500[kV]	5E5 V	Overvoltage amplitude
H	30[mm]	0.03 m	Thickness of the grading ring
D	350[mm]	0.35 m	Diameter of the grading ring
d	150[mm]	0.15 m	Distance to the grading ring from the end

The third column in the table is filled out automatically.

Importing the Geometry

The next step is to create your geometry, which also can be imported from an external program. COMSOL Multiphysics supports a multitude of CAD programs and file formats. In this example, import the geometry sequence from the COMSOL Multiphysics file format (.mph).

Note: The location of the files used in this exercise varies based on your installation. For example, if the installation is on your hard drive, the file path might be similar to C:\Program Files\COMSOL\COMSOL62\Multiphysics\applications\.

- 1 In the Geometry toolbar, click Insert Sequence .
- 2 Then navigate to your COMSOL Multiphysics installation folder, locate the subfolder ACDC_Module\Devices,_Capacitive and double-click the file high_voltage_insulator_geom_sequence.mph.
- 3 In the Geometry toolbar, click Build All .

4 Click the Go to Default View  button in the Graphics toolbar.

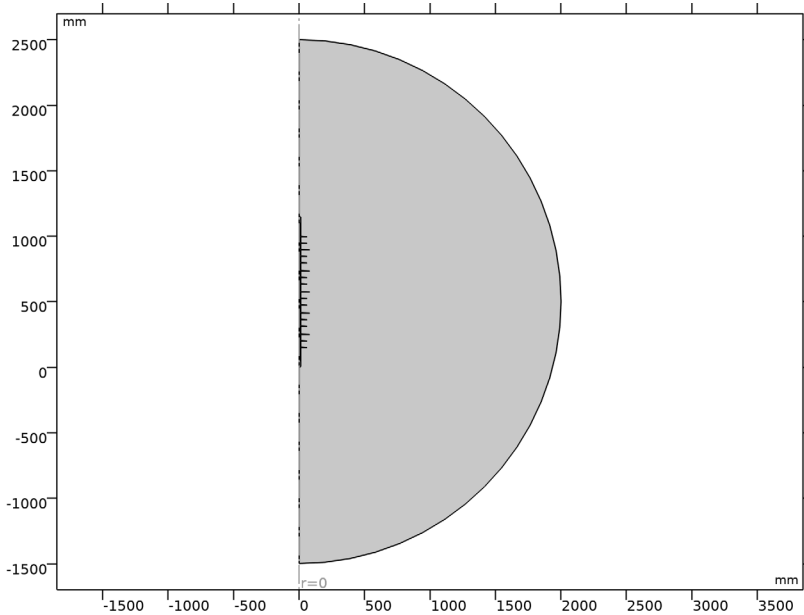

Materials

Ideally, the metal is an equipotential body and the electric field inside the metal is zero. Usually, the metal parts are excluded from the computation domain since their potential is known in advance. One can also include the metal parts and define the potential using the Domain Terminal feature. In this case, the domain of the metal parts is not solved and thus it is not necessary to assign a material to it. For other domains, the relative permittivity of the material needs to be defined, as listed below.

MATERIAL	RELATIVE PERMITTIVITY
Core rod	5
Weather shed	3
Air	1

Core Rod

- 1 In the Model Builder window, under Component 1 (comp1) right-click Materials and choose Blank Material.

- 2 In the Settings window for Material, type *Core Rod* in the Label text field.
- 3 Select Domains 3–5 only.
- 4 Locate the Material Contents section. In the table, set the value of relative permittivity to 5.

The Settings of the Core Rod material are shown in the figure to the right. Next, make similar settings for other materials.

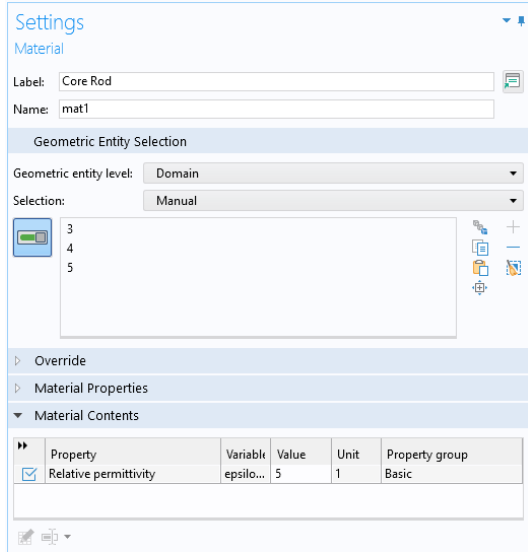

Weather Shed

- 1 Right-click Materials and choose Blank Material.
- 2 In the Settings window for Material, type *Weather Shed* in the Label text field.
- 3 Select Domain 7 only.
- 4 Locate the Material Contents section. In the table, set the value of relative permittivity to 3.

Air

- 1 Right-click Materials and choose Blank Material.
- 2 In the Settings window for Material, type *Air* in the Label text field.
- 3 Select Domain 1 only.
- 4 Locate the Material Contents section. In the table, set the value of relative permittivity to 1.

Electrostatics (es)

Now it is time to define the physics settings, such as material models, initial conditions, and boundary conditions. In this example, the Terminal feature is used to model metal fittings and grading rings at both the line and ground ends.

Metal Fitting, Line End

- 1 In the Model Builder window, under Component 1 (comp1) right-click Electrostatics (es) and choose Terminal .
- 2 In the Settings window for Terminal, type Metal Fitting, Line End in the Label text field.
- 3 Select Domain 2 only.
- 4 Locate the Terminal section. From the Terminal type list, choose Voltage.
- 5 In the V_0 text field, type V_i .

The Settings are shown in the figure to the right. Next, configure similar settings for the metal fitting at the ground end.

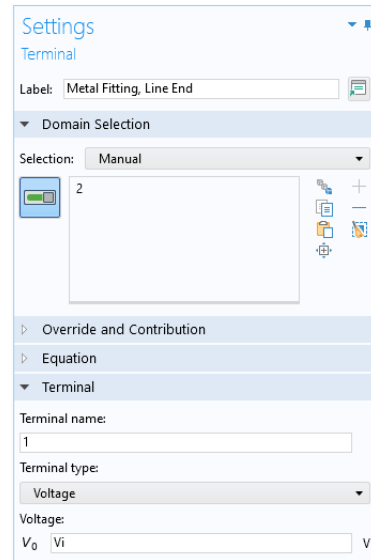

Metal Fitting, Ground End

- 1 In the Model Builder window, under Component 1 (comp1) right-click Electrostatics (es) and choose Terminal .
- 2 In the Settings window for Terminal, type Metal Fitting, Ground End in the Label text field.
- 3 Select Domain 6 only.
- 4 Locate the Terminal section. From the Terminal type list, choose Voltage.
- 5 In the V_0 text field, type 0.

Study 1 and Results, Without Grading Rings

Study 1

- 1 In the Model Builder window, click Study 1.
- 2 In the Settings window for Study, type Study 1, Without Grading Rings in the Label text field.
- 3 In the Home toolbar, click Compute . The Study node automatically defines a solution sequence for the simulation based on the selected physics and study type. In this case, the simulation only takes a few seconds to solve. Once it is finished, several default plots will show under the Results node.

Results

- 1 In the Model Builder window, expand the Results>Datasets node, then click Study 1, Without Grading Rings/Solution 1 (sol1).
- 2 In the Results toolbar, click Attributes  and choose Selection.
- 3 In the Settings window for Selection, locate the Geometric Entity Selection section.
- 4 From the Geometric entity level list, choose Domain.
- 5 Select Domains 2–7 only.
- 6 In the Model Builder window, under Results>Datasets click Revolution 2D 1.
- 7 In the Settings window for Revolution 2D, click to expand the Revolution Layers section. In the Revolution angle text field, type 360.
- 8 In the Model Builder window, under Results click Electric Potential (es).
- 9 In the Settings window for 2D Plot Group, type Electric Potential, Without Grading Rings in the Label text field and click Plot.

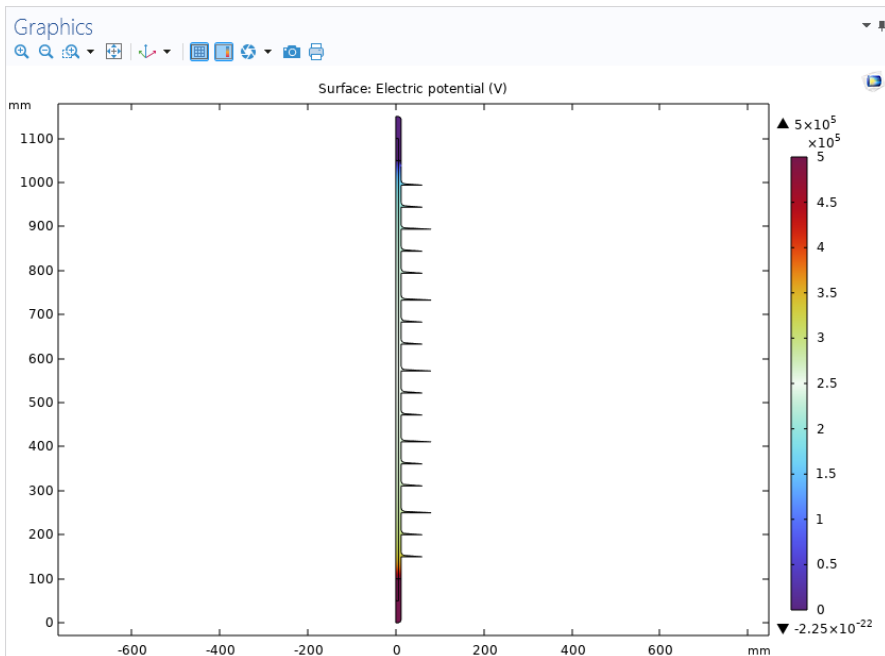

For high voltage insulators, it is of importance to install grading rings at both ends of the insulator to make the electric field distribution more uniform. In the following, add the grading rings and then compare the electric field distributions.

Geometry, with Grading Rings

Circle 2 (c2)

- 1 In the Geometry toolbar, click Circle .
- 2 In the Settings window for Circle, locate the Size and Shape section.
- 3 In the Radius text field, type $H/2$.
- 4 Locate the Position section. In the r text field, type $D/2$.
- 5 In the z text field, type d.

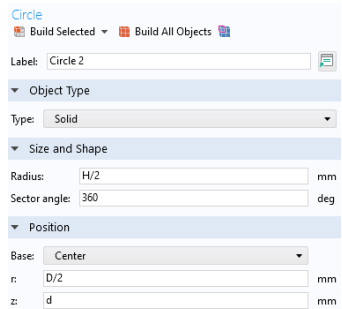

Circle 3 (c3)

- 1 Right-click Circle 2 (c2) and choose Duplicate.
- 2 In the Settings window for Circle, locate the Position section.
- 3 In the z text field, type $1150-d$.

Electrostatics (es)

Grading Ring, Line End

- 1 In the Physics toolbar, click Domains  and choose Terminal.
- 2 In the Settings window for Terminal, type Grading Ring, Line End in the Label text field.
- 3 Select Domain 8 only.
- 4 Locate the Terminal section. From the Terminal type list, choose Voltage.
- 5 In the V_0 text field, type V_i .

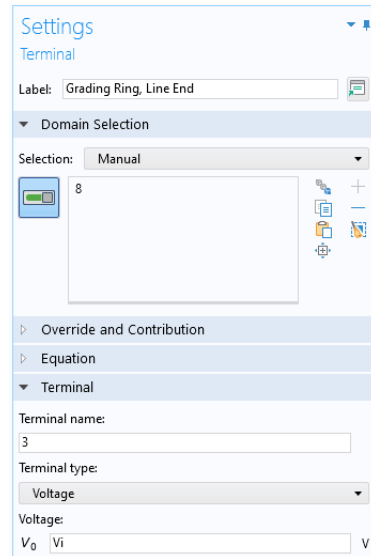



Grading Ring, Ground End

- 1 In the Physics toolbar, click Domains  and choose Terminal.
- 2 In the Settings window for Terminal, type Grading Ring, Ground End in the Label text field.

- 3 Select Domain 9 only.
- 4 Locate the Terminal section. From the Terminal type list, choose Voltage.
- 5 In the V0 text field, type 0.

Add Study

- 1 In the Home toolbar, click Add Study  to open the Add Study window.
- 2 Go to the Add Study window. Find the Studies subsection. In the Select Study tree, select General Studies>Stationary.
- 3 Right-click and choose Add Study.
- 4 In the Home toolbar, click Add Study  to close the Add Study window.

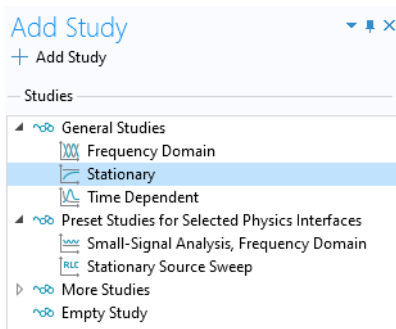

Study 2 and Results, With Grading Rings

Study 2



- 1 In the Settings window for Study, type Study 2, With Grading Rings in the Label text field.
- 2 In the Home toolbar, click Compute .

Results

- 1 In the Model Builder window, expand the Results>Datasets node, then click Study 2, With Grading Rings/Solution 2 (sol2).
- 2 In the Results toolbar, click Attributes  and choose Selection.
- 3 In the Settings window for Selection, locate the Geometric Entity Selection section.

- 4 From the Geometric entity level list, choose Domain.
- 5 Select Domains 2–9 only.
- 6 In the Model Builder window, under Results>Datasets click Revolution 2D 2.
- 7 In the Settings window for Revolution 2D, click to expand the Revolution Layers section. In the Revolution angle text field, type 360.
- 8 In the Model Builder window, under Results click Electric Potential (es).
- 9 In the Settings window for 2D Plot Group, type Electric Potential, With Grading Rings in the Label text field.

Electric Potential, Revolved Geometry (es) 1

- 1 In the Model Builder window, click Electric Potential, Revolved Geometry (es) 1.
- 2 In the Settings window for 3D Plot Group, locate the Plot Settings section.
- 3 Clear the Plot dataset edges check box.
- 4 In the Electric Potential, Revolved Geometry (es) 1 toolbar, click Plot .
- 5 Click the Go to Default View  button in the Graphics toolbar.
- 6 The resulting plot is shown below.

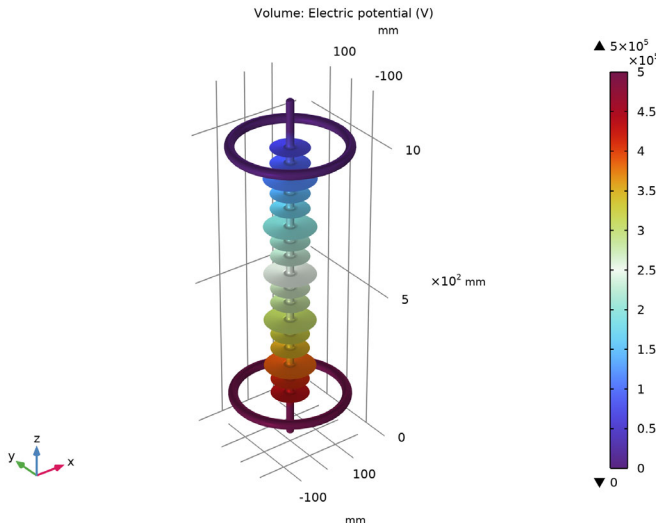



The electric potential distribution of the high voltage insulator.

The flashover voltage of the insulator is mainly determined by properties of the vertical component of the tangential electric field. Next, compare the tangential

electric field along the surface of the first six sheds. It is convenient to first define the corresponding boundary selection.

Definitions

Shed Surface

- 1 In the Definitions toolbar, click Explicit .
- 2 In the Settings window for Explicit, type Shed Surface in the Label text field.
- 3 Locate the Input Entities section. From the Geometric entity level list, choose Boundary.
- 4 Select Boundaries 22–33, 57–62, and 78–83 only.
- 5 Click the Zoom to Selection  button in the Graphics toolbar.

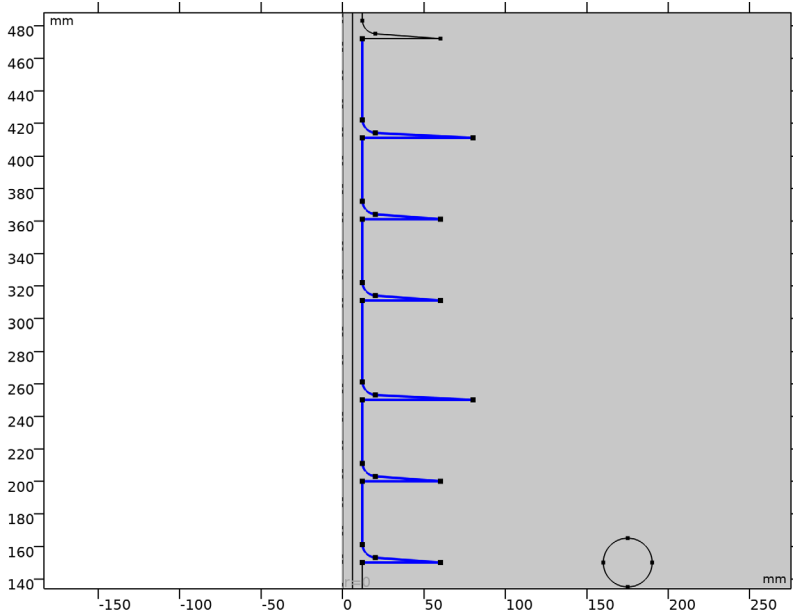



Results

Tangential Electric Field, z-Component

- 1 In the Home toolbar, click Add Plot Group  and choose 1D Plot Group.

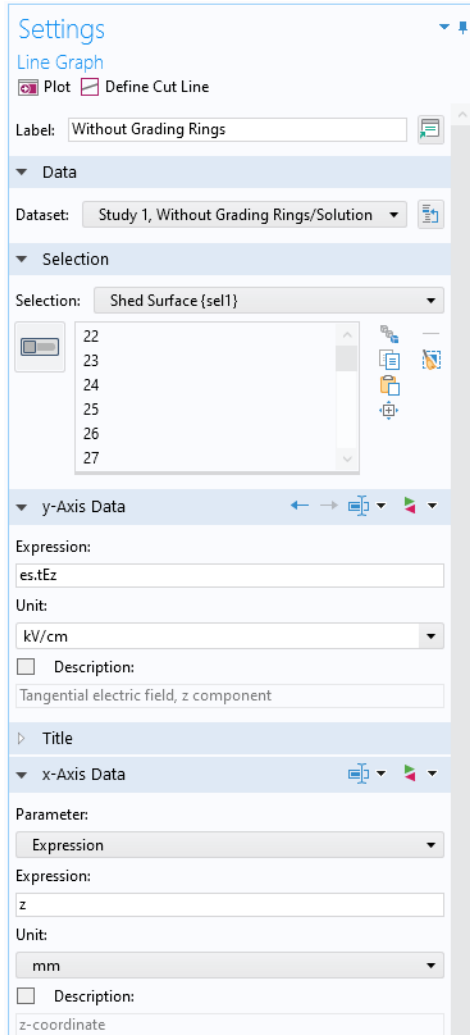
- 2 In the Settings window for 1D Plot Group, type Tangential Electric Field, z-Component in the Label text field.
- 3 Right-click Tangential Electric Field, z Component and choose Line Graph.
- 4 In the Settings window for Line Graph, type Without Grading Rings in the Label text field.
- 5 Locate the Data section. From the Dataset list, choose Study 1, Without Grading Rings/Solution 1 (sol1).
- 6 Locate the Selection section. From the Selection list, choose Shed Surface.
- 7 Locate the y-Axis Data section. In the Expression text field, type $es.tEz$.
- 8 In the Unit field, type kV/cm.
- 9 Locate the x-Axis Data section. From the Parameter list, choose Expression.
- 10 In the Expression text field, type z.
- 11 Click to expand the Legends section. Select the Show legends check box.
- 12 From the Legends list, choose Manual. In the table, enter Without grading rings.
- 13 Right-click Without Grading Rings and choose Duplicate. In the Settings window for Line Graph, type With Grading Rings in the Label text field.
- 14 Locate the Data section. From the Dataset list, choose Study 2, With Grading Rings/Solution 2 (sol2).
- 15 Locate the Selection section. From the Selection list, choose Shed Surface.
- 16 Click to expand the Title section. From the Title type list, choose None.
- 17 Locate the Legends section. In the table, enter With grading rings.



- 18 In the Model Builder window, click Tangential Electric Field, z Component.
- 19 In the Tangential Electric Field, z Component toolbar, click Plot . The resulting plot is shown below.

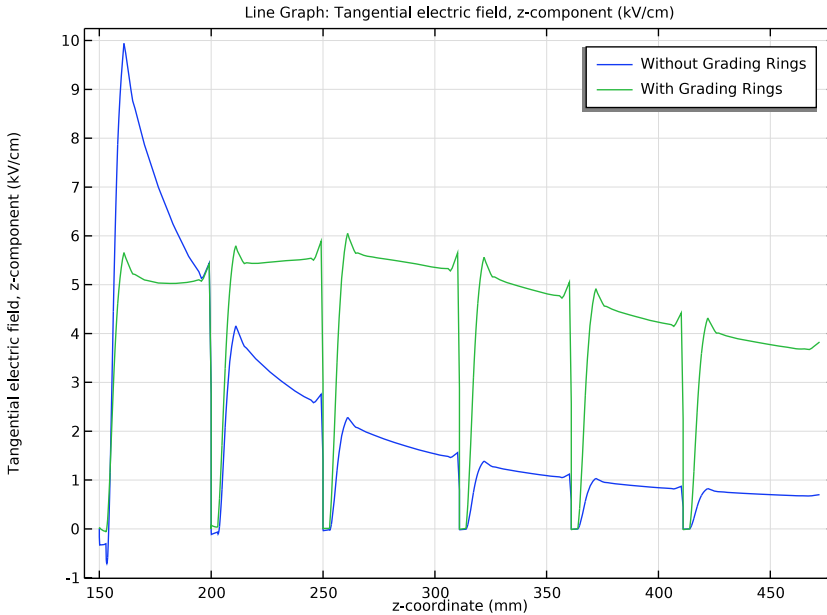

Comparison of the z component of the tangential electric field along the surface of the first six sheds from the line end without and with grading rings.

The above figure shows that the inhomogeneity and the maximum of the field are greatly reduced with the installation of the grading rings. In this way, the grading rings help the insulator to withstand a higher overvoltage and thus improve the external insulation of the power system.

Tutorial 2: Computing the Impedance of a 3D Inductor

Inductors are used in many applications for low-pass filtering or for impedance matching of predominantly capacitive loads. They are used in a wide frequency range from near static up to several MHz. An inductor usually has a magnetic core to increase the inductance while keeping its size small. The magnetic core also reduces the electromagnetic interference with other devices, for a given inductance, as the magnetic flux tends to stay within it. Because there are only crude analytical or empirical formulas available to calculate impedances, computer simulations or measurements are necessary during the design stage. In general, inductor modeling is more complex than modeling resistors and capacitors but similar principles apply. Using an external CAD software to design and draw the model, the geometry is imported into the AC/DC Module for static and frequency domain analysis. The inductor geometry is shown in [Figure 8](#).

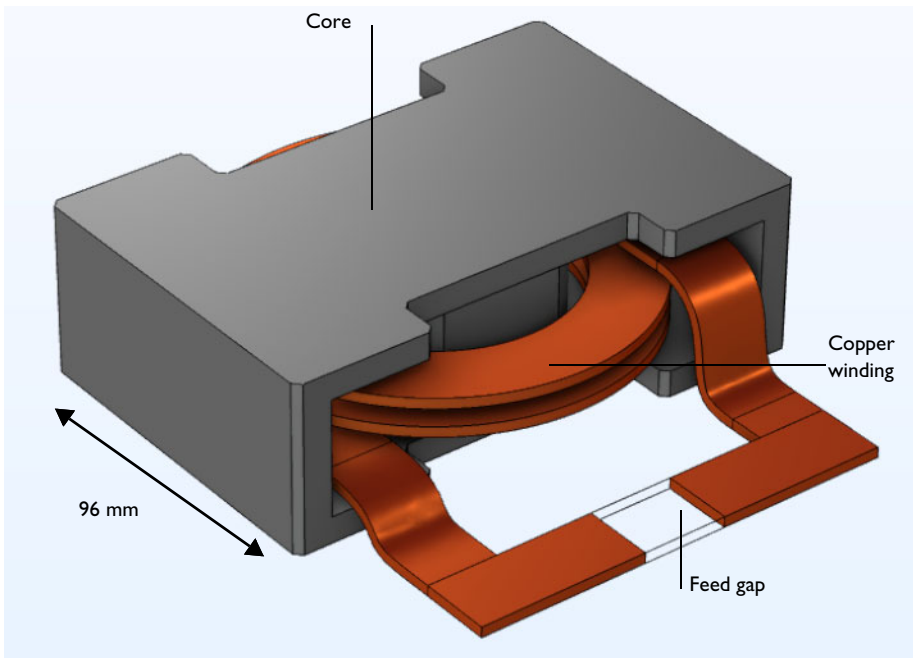

Figure 8: The inductor geometry.

First a magnetostatic simulation is performed to get the DC inductance. At low frequencies capacitive effects are negligible. A relevant equivalent circuit model is an ideal inductor in a series with an ideal resistor. The inductance and the resistance are both computed in the magnetostatic simulation. At a high

frequency, capacitive effects become significant. The equivalent circuit model involves connecting an ideal capacitor in parallel with the DC circuit. The circuit parameters are obtained by analyzing the frequency dependent impedance obtained from a frequency domain simulation. In this tutorial, the AC analysis is done up to the point when the frequency dependent impedance is computed.



These step-by-step instructions guide you through the detailed modeling of an inductor in 3D. The module also has a physics interface to model electrical circuits, which is detailed in the magnetostatic part of this model.

The first step is to perform a DC simulation.







Model Wizard

Note: These instructions are for the user interface on Windows but apply, with minor differences, also to Linux and Mac.

1 To start the software, double-click the COMSOL icon on the desktop. When the software opens, you can choose to use the Model Wizard to create a new COMSOL Multiphysics model or Blank Model to create one manually. For this tutorial, click the Model Wizard button.

If COMSOL Multiphysics is already open, you can start the Model Wizard by selecting New  from the File menu and then click Model Wizard .

The Model Wizard guides you through the first steps of setting up a model. The next window lets you select the dimension of the modeling space.

- 2 In the Space Dimension window click 3D .
- 3 In the Select Physics tree under AC/DC, expand Electromagnetic Fields  and select Magnetic Fields (mf) .
- 4 Click Add then click Study .
- 5 In the Select Study window under General Studies, click Stationary .
- 6 Click Done .

Importing the Geometry

The main geometry is imported from a file. Air domains are typically not part of a CAD geometry, so these are added to the model. For convenience, three

additional domains are defined in the CAD file and then used to define a narrow feed gap where an excitation is applied.

Note: The location of the files used in this exercise varies based on the installation. For example, if the installation is on your hard drive, the file path might be similar to: C:\Program Files\COMSOL\COMSOL62\Multiphysics\applications\.

Import 1

1 In the Home toolbar, click Import .

Note: On Linux and Mac, the Home toolbar refers to the specific set of controls near the top of the Desktop.

2 In the Settings window under Import, click Browse. Then navigate to your COMSOL Multiphysics installation folder, locate the subfolder ACDC_Module\Devices,_Inductive, select the file inductor_3d.mphbin and click Open.

3 Click Import.

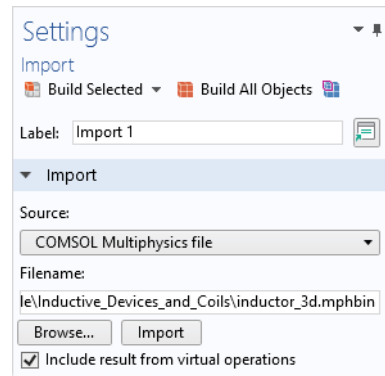

Sphere 1

1 In the Geometry toolbar, click Sphere .



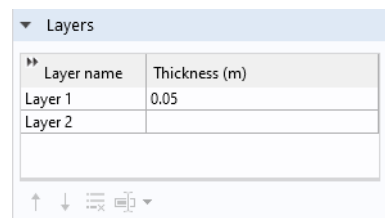
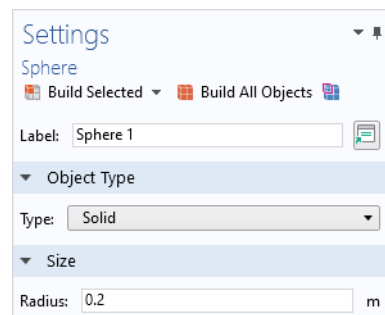

2 Go to the Settings window for Sphere. Under Size in the Radius text field, enter 0.2.

3 Click to expand the Layers section. In the associated table, under Thickness enter 0.05.

4 Click the Build All Objects  button.



Form Union

- 1 In the Model Builder under Geometry 1, click Form Union .
- 2 In the Settings window for Form Union/Assembly, click Build All .
- 3 In the Graphics window toolbar, click the Zoom Extents  button and then the Wireframe Rendering  button.

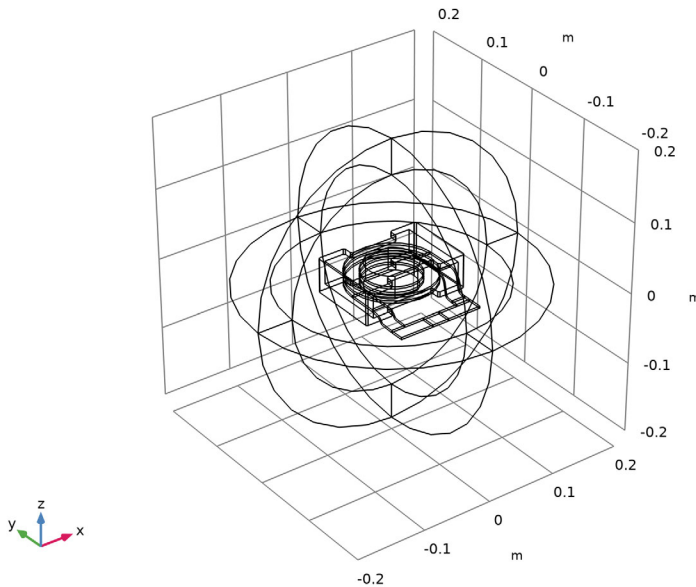
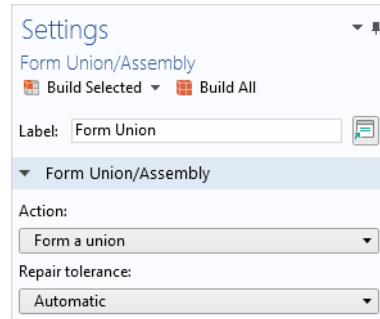

The geometry should match this figure.



Definitions - Selections

Use the Selection feature available under the Definitions node to make the setup of materials and physics interfaces easier. Start by defining the domain group for the inductor winding and continue by adding other useful selections. These steps illustrate how to set up the Explicit nodes and rename the geometric selections accordingly.

- 1 In the Definitions toolbar, click Explicit .

- 2 Repeat Step 1 and add a total of six (6) Explicit nodes . Or right-click the first Explicit node and select Duplicate .

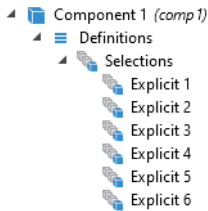

The following steps are done one at a time for each node using the table below.

- 3 In the Model Builder click an Explicit node  to open the Settings window.

Note: There are many ways to select geometric entities. When you know the domain to add, such as in this exercise, you can click the Paste Selection button  and enter the information in the Selection text field. In this example for the Explicit 1 node, enter 7, 8, 14 in the Paste Selection window. For more information about selecting geometric entities in the Graphics window, see the *COMSOL Multiphysics Reference Manual*.

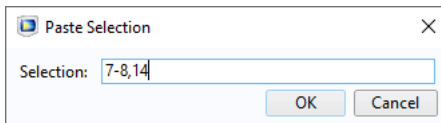

- 4 In the Settings window under Input Entities, select Domain from the Geometric entity level list. Use the table as a guide, and in the Graphics window, select the domains as indicated. Then rename the node by changing its Label in the Settings window.

DEFAULT NODE NAME	SELECT THESE DOMAINS	NEW NAME FOR THE NODE
Explicit 1	7, 8, and 14	Winding
Explicit 2	9	Gap
Explicit 3	6	Core
Explicit 4	1–4 and 10–13	Infinite Elements
Explicit 5	1–6 and 9–13	Nonconducting
Explicit 6	5, 6, and 9	Nonconducting without IE

5 After renaming all the nodes under Definitions, the sequence of nodes should match this figure.

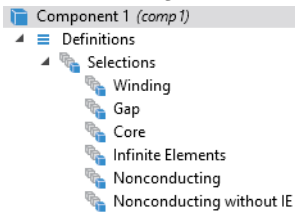

Definitions - Infinite Elements

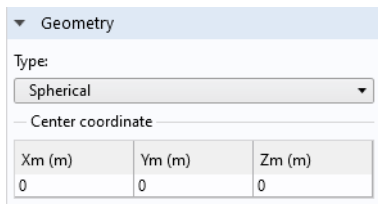

Use the Infinite Element feature available under the Definitions node to emulate an infinite open space surrounding the inductor. The infinite element coordinate scaling is recognized by any physics interface supporting it - other physics interfaces are automatically disabled in the infinite element domains.

- 1 In the Definitions toolbar click Infinite Element Domain ∞ .
- 2 Go to the Settings window for Infinite Elements. Under Domain Selection select Infinite Elements from the Selection list.
- 3 Under Geometry from the Type list, select Spherical.



Magnetic Fields (mf)

The model is solved everywhere except in the feed gap region. By keeping this void, its default boundary conditions support surface currents closing the current loop. In inductor modeling it is crucial to respect current conservation as this is a law of nature (Ampère's law).

- 1 In the Model Builder click Magnetic Fields .
- 2 In the Settings window for Magnetic Fields, select Domains 1–8 and 10–14 only (all domains except 9). Or first click the Clear Selection button , then click the Paste Selection button  and enter 1–8, 10–14 in the Selection text field.

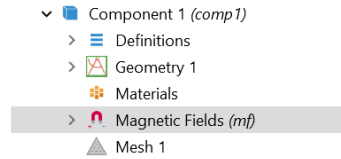



Free Space I

The default feature is tailored for being used in free space. In frequency domain and transient modeling, stabilization conductivity may be required but not for stationary modeling.

- 1 In the Settings window for Free Space, locate the Stabilization section.
- 2 From the σ_{stab} list choose User Defined. In the associated text field, type 0[S/m].









Ampère's Law in Solids I

Additional features are added for solid domains, starting with the core.

- 1 In the Physics toolbar click Domains  and choose Ampère's Law in Solids .
- 2 In the Settings window for Ampère's Law in Solids, under Domain Selection, choose Core from the Selection list.

Coil I

A dedicated feature is added for the solid copper winding of the inductor. This feature makes it easier to excite the model in various ways.

- 1 In the Physics toolbar click Domains  and choose Coil .
- 2 In the Settings window for Coil, under Material Type, choose Solid.
- 3 In the Settings window for Coil, under Domain Selection, choose Winding from the Selection list.
- 4 In the Model Builder, expand the Coil 1  node.
- 5 Right-click the Geometry Analysis 1  subnode and choose Output . There is already a default Input node.
- 6 Click the Input 1  node.
- 7 In the Settings window for Input 1, click the Paste Selection button  and enter 58 in the Selection text field.
- 8 Click OK.
- 9 Click the Output 1  node.

10 In the Settings window for Output 1, click the Paste Selection button  and enter 79 in the Selection text field.

11 Click OK.

The Coil with default settings will treat it as a solid conductor and apply a current of 1 A flowing from the input to the output.

The node sequence under Magnetic Fields should at this point match this figure.

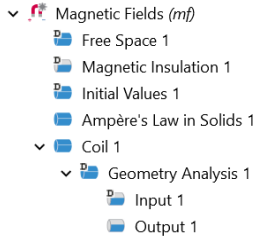

Materials

Now define the material settings for the different parts of the inductor. Use the Selections defined in the previous section.

Copper

1 In the Home toolbar click Add Material .

2 Go to the Add Material window. In the Materials tree under AC/DC, right-click Copper and choose  Add to Component 1 from the menu.

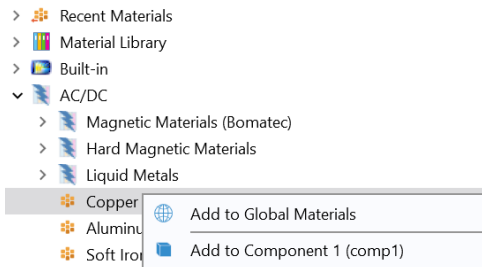

3 In the Model Builder, click Copper .

4 Go to the Settings window for Material. Under Geometric Entity Selection select Winding from the Selection list.

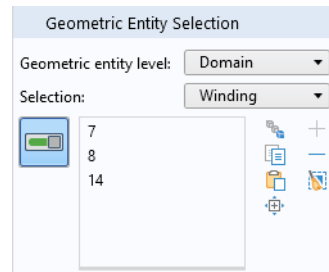

User-Defined Material 3

The core material is not included in the material library so it is entered as a user-defined material.

- 1 In the Materials toolbar click Blank Material .
- 2 In the Settings window for Material, in the Label text field, type Core.
- 3 Under Geometric Entity Selection select Core from the Selection list.

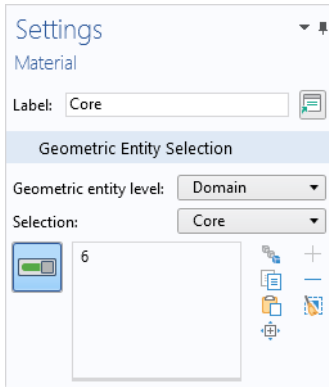

- 4 Under Material Contents in the table, enter these settings in the Value column:
 - 1e3 for the Relative permeability
 - 0 for the Electrical conductivity
 - 1 for the Relative permittivity

Material Contents					
	Property	Variable	Value	Unit	Property group
<input checked="" type="checkbox"/>	Relative permeability	mur_i...	1e3	1	Basic
<input checked="" type="checkbox"/>	Electrical conductivity	sigma...	0	S/m	Basic
<input checked="" type="checkbox"/>	Relative permittivity	epsilo...	1	1	Basic

The node sequence under Materials should match the figure.

- ▼  Materials
 - >  Copper (*mat1*)
 - >  Core (*mat2*)

Mesh 1

The infinite elements region requires a swept mesh to maintain a good effective element quality despite the steep radial scaling. This meshing method should be enabled by default.

- 1 In the Model Builder click Mesh 1 .
- 2 In the Settings window for Mesh 1, make sure that Physics-Controlled Mesh is selected.

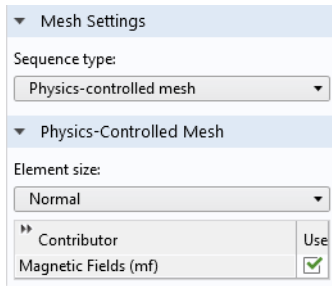





- 3 Make sure that Magnetic Fields is selected in the Contributor list.

In the Mesh toolbar click Build Mesh .

Study 1

Before the magnetostatic model is ready to solve an additional study step needs to be added for computing the exciting coil current.

- 1 Right-click the Study 1  node and select Study Steps>Other>Coil Geometry Analysis .
- 2 Right-click Coil Geometry Analysis  and select Move Up . The Study node should at this stage match this figure.

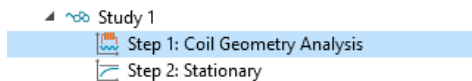

- 3 In the Study toolbar click Compute .

Results

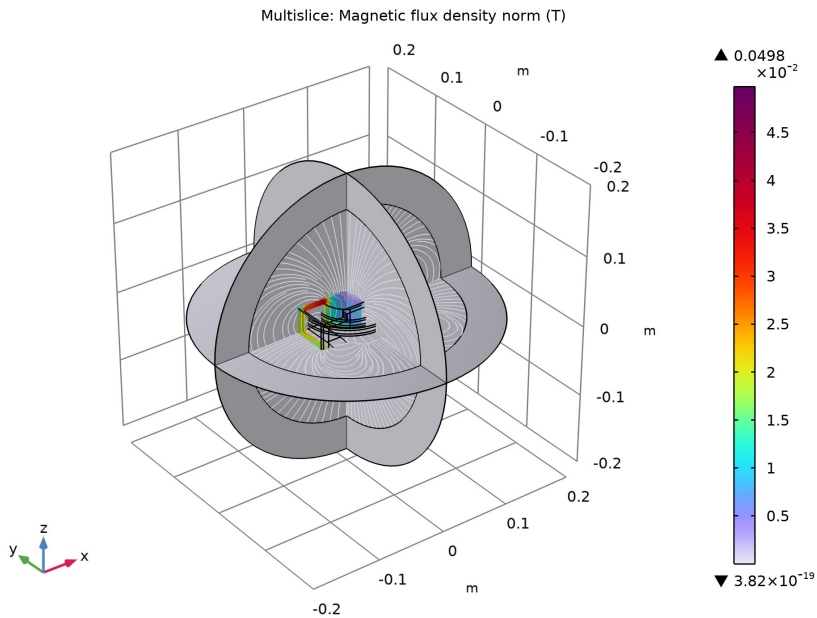

Magnetic Flux Density

The default plot group shows the magnetic flux density norm. At this point it is important to consider whether the results make sense and to try and detect any modeling errors.



Datasets and Selections

By adding Selections and adjusting the Datasets under the Results node you can create more interesting plots.

- 1 In the Model Builder, expand the Results>Datasets node. Right-click Study 1/Solution 1  and choose Duplicate .
- 2 Right-click Study 1/Solution 1 (3)  and choose Selection. A Selection node is added to the Model Builder.

- 3 Go to the Settings window for Selection. Under Geometric entity selection:
 - From the Geometric entity level list, select Domain.
 - From the Selection list, select Winding.

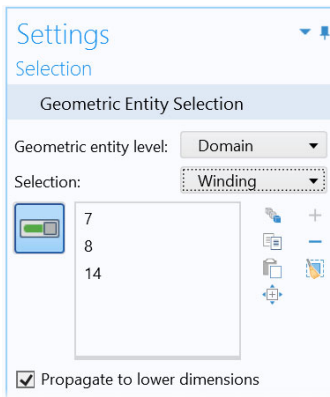

- 4 Right-click Study 1/Solution 1 (1) and choose Duplicate .
- 5 Right-click Study 1/Solution 1 (4) and choose Selection. A Selection node is added to the Model Builder.

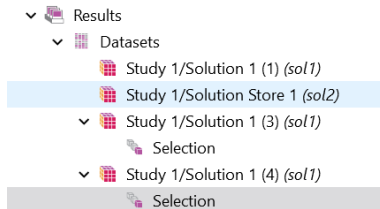

- 6 Go to the Settings window for Selection. Under Geometric Entity Selection:
 - From the Geometric entity level list, select Domain.
 - From the Selection list, select Core.

|B| and Coil Direction

- 1 In the Results toolbar, click 3D Plot Group .

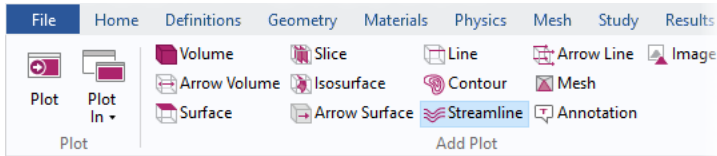

An additional toolbar containing Plot Tools for the 3D Plot Group appears when the 3D Plot Group is selected in the Model Builder. Rename 3D Plot Group 2 as |B| and Coil Direction by typing the new name in the Label text field.

- 2 On the |B| and Coil Direction toolbar, click Streamline .



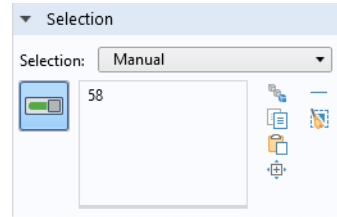



- 3 Go to the Settings window for Streamline. Click Replace Expression  in the upper-right corner of the Expression section. From the menu, choose Component 1>Magnetic Fields>Coil parameters>mf.coil1.eCoilx,...,mf.coil1.eCoilz - Coil direction.

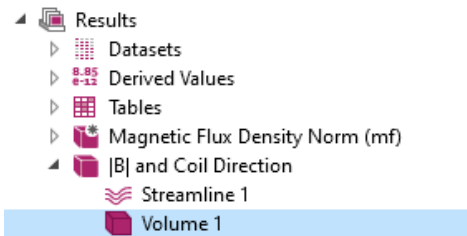

- 4 Under Selection, click the Paste Selection button  and enter 58 in the Selection text field.
- 5 Click OK
- 6 Right-click |B| and Coil Direction  and choose Volume .
- A Volume 1 node is added to the Model Builder.



- 7 Go to the Settings window for Volume. Under Data from the Dataset list, select Study 1/Solution 1 (4).
- 8 Go to the Settings window for Volume. Under Coloring and Style, Click the Change Color Table  button.
- 9 In the Color Table dialog box, select Rainbow>Prism in the tree.
- 10 Click OK.
- 11 Click the Plot  button.

In the Graphics window toolbar, click the Zoom In  button once. Click also the Show Grid  button to toggle off the grid.

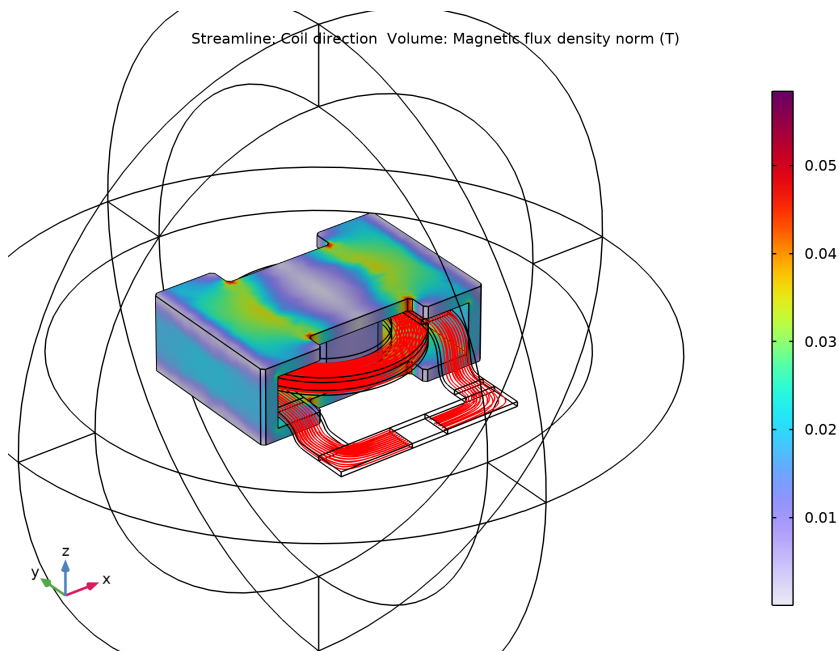
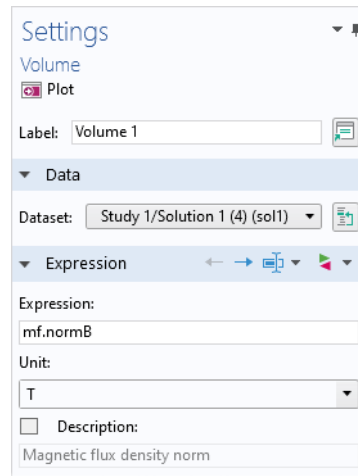

Derived Values

Next, evaluate the coil inductance and resistance and compare them respectively to the inductance estimated from the total magnetic energy and to the resistance defined using Ohm's law.

- 1 In the Results toolbar click Global Evaluation .
- 2 In the Settings window for Global Evaluation, locate the Expression section.
- 3 In the table, enter the following settings:

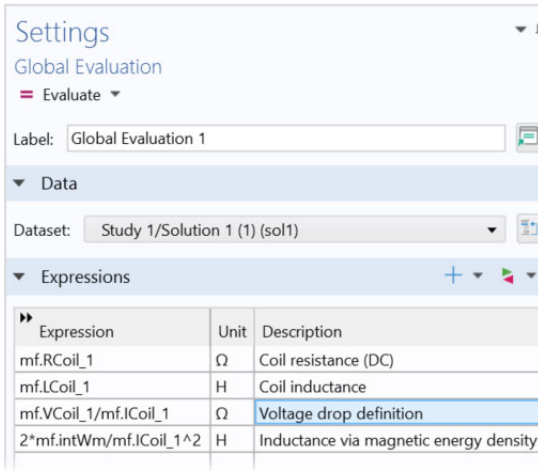

Expression	Unit	Description
mf.RCoil_1	Ω	Coil resistance (DC)
mf.LCoil_1	H	Coil inductance
mf.VCoil_1/mf.ICoil_1	Ω	Voltage drop definition
2*mf.intWm/mf.ICoil_1^2	H	Inductance via magnetic energy density

- 4 Click the Evaluate  button.

Compare the results in the Table window. The results could be different depending on the format settings above the table.

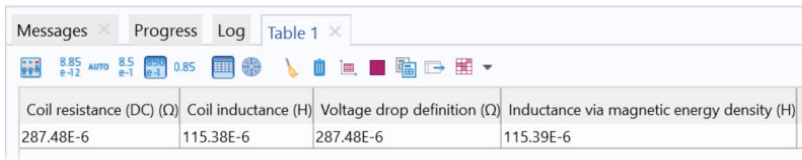

Coil resistance (DC) (Ω)	Coil inductance (H)	Voltage drop definition (Ω)	Inductance via magnetic energy density (H)
287.48E-6	115.38E-6	287.48E-6	115.39E-6

Magnetic Fields (mf)

As shown in the Magnetic Flux Density plot, this is effectively contained within the core. Thus, there should be little need to use infinite elements in this model. Solve the model without the infinite elements to test this hypothesis.

- 1 In the Model Builder click Magnetic Fields .
- 2 In the Settings window for Magnetic Fields, select Domains 5–8 and 14 only.

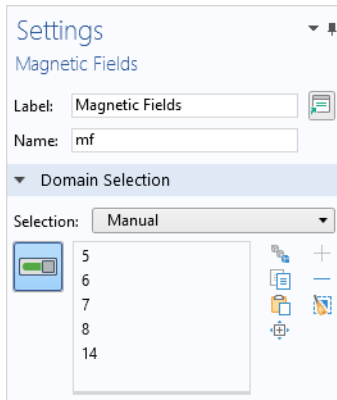

Study 1

- 1 In the Study toolbar click Compute .

Derived Values

- 1 In the Model Builder under Results>Derived Values, click Global Evaluation 1 .

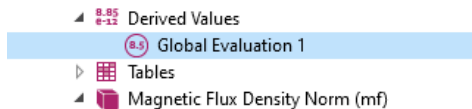



- 2 In the Settings window for Global Evaluation, click the Evaluate  button.

The resistance and inductance values display in the Table window.

Model Wizard

Next, connect a simple circuit to the model.

- 1 In the Physics toolbar click Add Physics .
- 2 Go to the Add Physics window. In the tree under AC/DC, click Electrical Circuit (cir)  and click + Add to Component 1.
- 3 Close the Add Physics window.

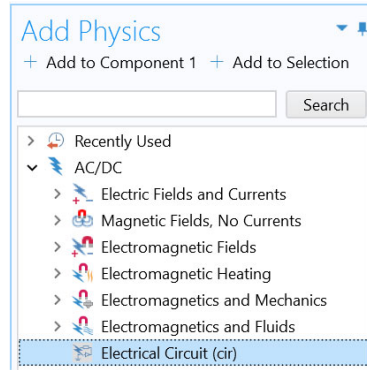

Magnetic Fields (mf)

Change the coil excitation to connect to the circuit part of the model.

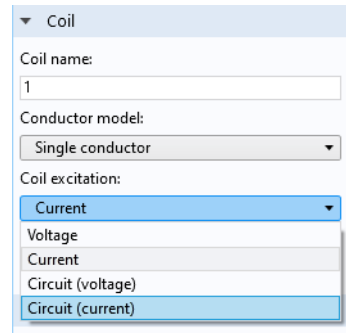

- 1 In the Model Builder, under Component 1 (comp1)>Magnetic Fields (mf), click Coil 1.
- 2 In the Settings window for Coil , change the Coil excitation to Circuit (current), as in the figure.



Electrical Circuit (cir)

Add a resistor and a voltage source in series with the inductor.

Voltage Source 1

- 1 In the Model Builder select the Electrical Circuit (cir)  node.
- 2 On the Electrical Circuit toolbar click Voltage Source .

Go to the Settings window for Voltage Source. The default settings correspond to a DC source of 1 V. Under Node Connections enter 1 and 0 in the Node names table as in the figure to the right.

Settings
Voltage Source

Label: Voltage Source 1

Name: V1

Node Connections

Label	Node names
p	1
n	0

Figure



Device Parameters

Source type:
General source

Voltage:
 V_{src} 1[V]

Resistor 1

- 1 On the Electrical Circuit toolbar click Resistor .
- 2 Go to the Settings window for Resistor. Under Node Connections enter 1 and 2 in the Node names table as in the figure to the right.
- 3 Under Device Parameters in the R text field, enter 100[mohm].

Node Connections

Label	Node names
p	1
n	2

Figure

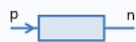

Device Parameters

Resistance:
 R 100[mohm] Ω

External I Vs. U I

There is a special feature for connecting the circuit to the finite elements model.

- 1 On the Electrical Circuit toolbar click External I Vs. U .
- 2 In the Settings window for External I Vs. U under Node Connections, enter Node names as in to the figure to the right.
- 3 Under External Device, from the Electric potential V list choose Coil voltage (mf/coil1).

The sequence of nodes under Electrical Circuit should match this figure.

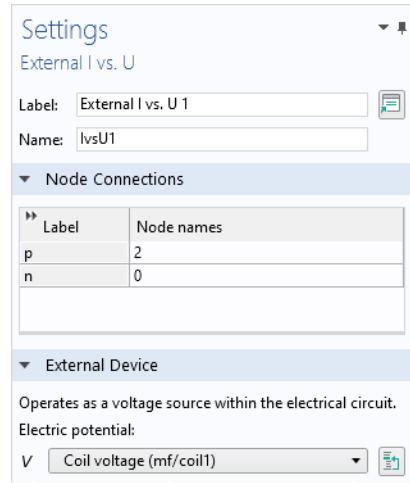
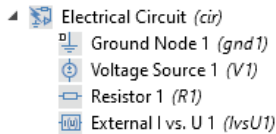

Study I

- 1 In the Study toolbar click Compute .

Derived Values

Next, evaluate the current.

- 1 In the Results toolbar click Global Evaluation  (8.5).
- 2 In the Settings window for Global Evaluation, locate the Expression section.

3 In the table, enter the following settings:

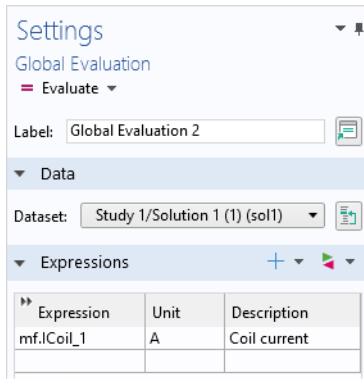

4 Click the Evaluate = button.

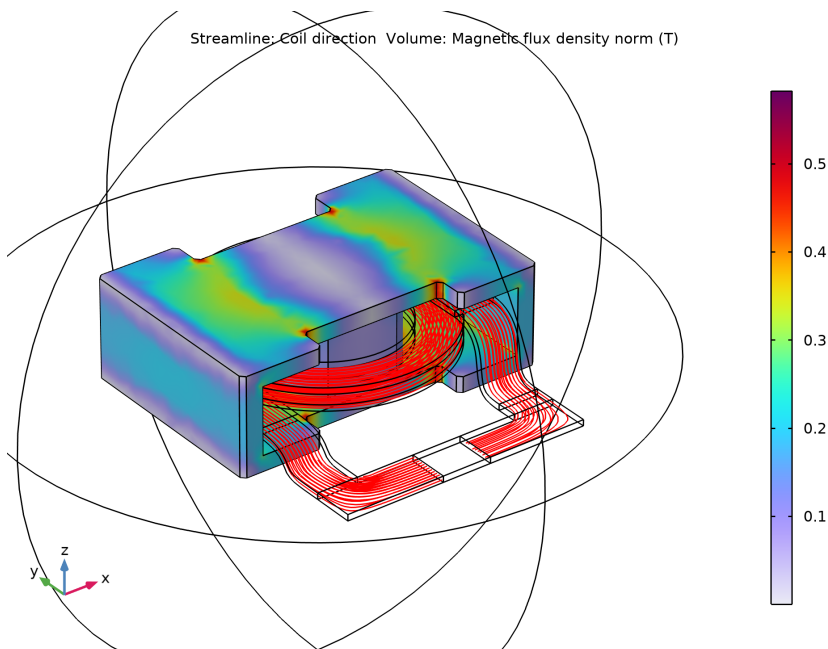

The current is now limited to approximately 10 A, which is dictated mostly by the external resistor with a much larger resistance than that of the winding. In the previous step, a current of 1 A was applied. Thus, the magnetic flux density is about 10 times larger in the latest solution.

This can also be seen in the 3D Plot Group.



Model Wizard - Add a Second Study

Now, set up the model for computing the frequency-dependent impedance.

- 1 In the Home toolbar click Add Study .
- 2 In the Add Study window click Frequency Domain .
- 3 In the Physics interfaces in study table, under Solve, click to clear the check mark , which removes the Electrical Circuit (cir) interface.
- 4 Click + Add Study.
- 5 Close the Add Study window.

A Study 2 node with a Frequency Domain study step is added to the Model Builder.

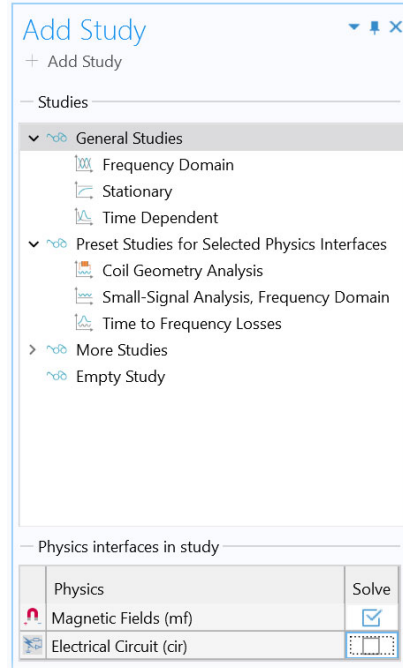
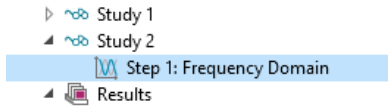

Definitions

At high frequencies, the skin depth of the copper conductor in the winding becomes difficult to resolve. The solution is to exclude the interior of the copper domain from the simulation and instead represent the winding by a boundary condition, which introduces surface losses via an equivalent surface impedance. For this purpose add a boundary selection and an associated surface material.

Conductor Boundaries

- 1 In the Definitions toolbar click Explicit .

- 2 Select Domains 7, 8, and 14 only.
- 3 Go to the Settings window for Explicit. Under Output Entities section, select Adjacent boundaries.
- 4 In the Label text field enter Conductor Boundaries.

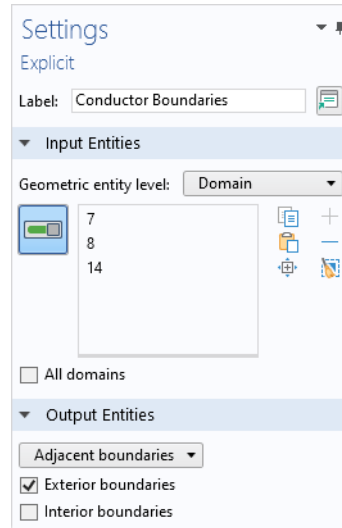

Materials

Copper 1

- 1 In the Home toolbar click Add Material .
- 2 Go to the Add Material window. In the Materials tree under AC/DC, right-click Copper and choose Add to Component 1 from the menu.
- 3 Close the Add Material window.
- 4 In the Model Builder, click Copper 1.

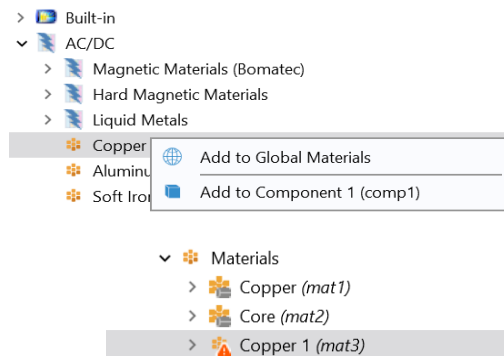

- 5 Go to the Settings window for Material. Under Geometric Entity Selection:
 - From the Geometric entity level list, select Boundary.
 - From the Selection list, select Conductor Boundaries.

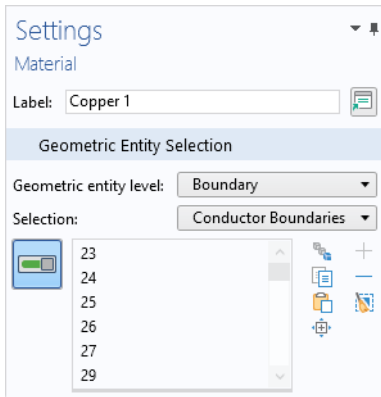

Magnetic Fields (mf)

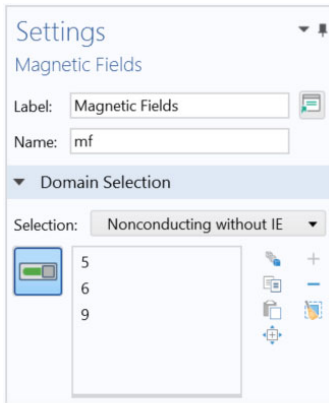

- 1 In the Model Builder click Magnetic Fields .
- 2 Go to the Settings window for Magnetic Fields. Under Domain Selection from the Selection list, select Nonconducting without IE.



Ampère's Law in Solids 2

Apart from the surface losses in the copper conductor, there are also AC losses in the core. The core loss is introduced by specifying an effective complex

permeability for the magnetic iron in the core, a quantity which is often available from the manufacturer. There is a specific constitutive relation for this.



- 1 In the Physics toolbar click Domains  and choose Ampère's Law in Solids .

A second Ampère's Law in Solids node is added to the Model Builder.

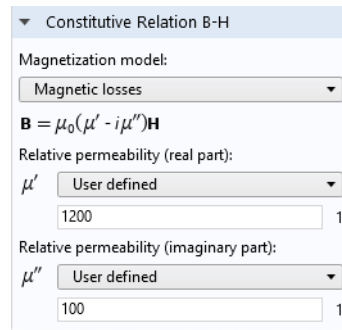
- 2 Go to the Settings window for Ampère's Law in Solids. Under Domain Selection, from the Selection list, select Core.
- 3 In the Settings window for Ampère's Law in Solids, locate the Constitutive Relation B-H section.
- 4 From the Magnetization model list, choose Magnetic losses.
- 5 From the μ' list, choose User defined. In the μ' text field, type 1200.
- 6 From the μ'' list, choose User defined. In the μ'' text field, type 100.



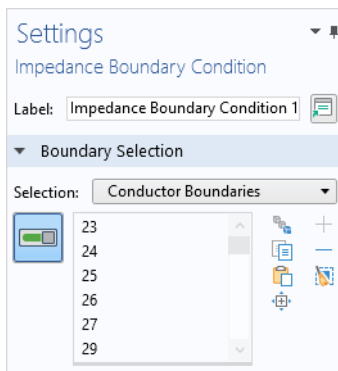

Impedance Boundary Condition 1

- 1 In the Physics toolbar click Boundaries  and choose Impedance Boundary Condition .
- 2 Go to the Settings window for Impedance Boundary Condition. Under Boundary Selection from the Selection list, select Conductor Boundaries.



Lumped Port 1

With the Coil replaced by the Impedance Boundary Condition a different boundary feature, which is more appropriate for high frequency modeling, must be used to excite the model.

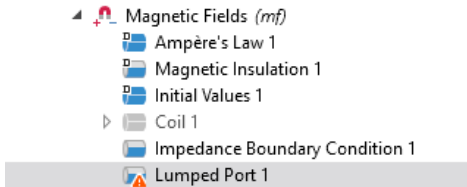

- 1 In the Physics toolbar click Boundaries  and choose Lumped Port  .
A Lumped Port node is added to the sequence in the Model Builder.



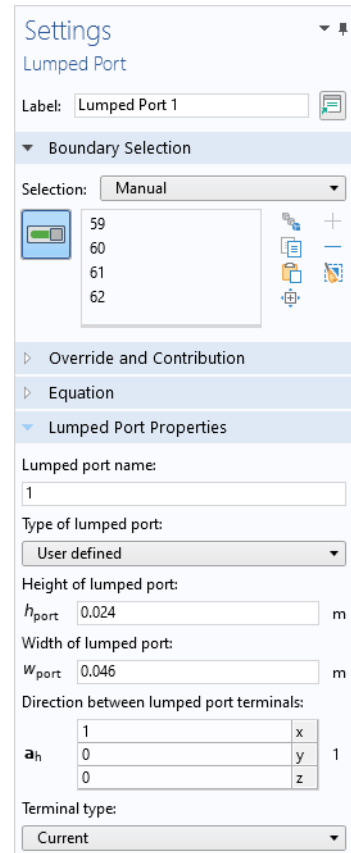

- 2 Go to the Settings window for Lumped Port. Select Boundaries 59–62 only.
The geometrical parameters of the boundary set need to be entered manually.
- 3 Under Lumped Port Properties from the Type of lumped port list, select User defined.
 - In the h_{port} text field, enter 0.024.
 - In the w_{port} text field, enter 0.046.
- 4 Specify the \mathbf{a}_h vector as in the figure to the right.
- 5 From the Terminal type list, select Current.



Disable Coil 1



The Coil does not apply to an active domain anymore so it needs to be disabled. In the Model Builder under Magnetic Fields, right-click Coil 1  and choose Disable . The node is unavailable.

Disable Ampère's Law in Solids 1

This feature does not apply to an active domain anymore so it needs to be disabled. In the Model Builder under Magnetic Fields, right-click Ampère's Law in Solids 1  and choose Disable . The node is unavailable.

Study 2

Set up a frequency sweep from 1 to 10 MHz in steps of 0.25 MHz.

- 1 In the Model Builder expand the Study 2 node and click Step 1: Frequency Domain .
- 2 From the Frequency unit list, choose MHz.
- 3 Under Study Settings click the Range button .
- 4 In the Range window, enter these settings:
 - In the Start text field, enter 1.
 - In the Step text field, enter 0.25.
 - In the Stop text field, enter 10.
- 5 Click Replace.
- 6 In the Study toolbar click Compute .

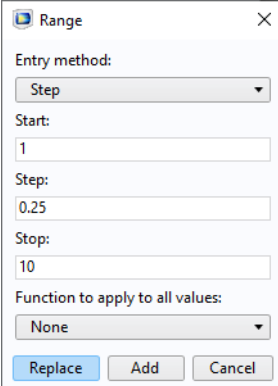

Range

Entry method:
Step

Start:
1

Step:
0.25

Stop:
10

Function to apply to all values:
None

Replace Add Cancel

Results



Magnetic Flux Density

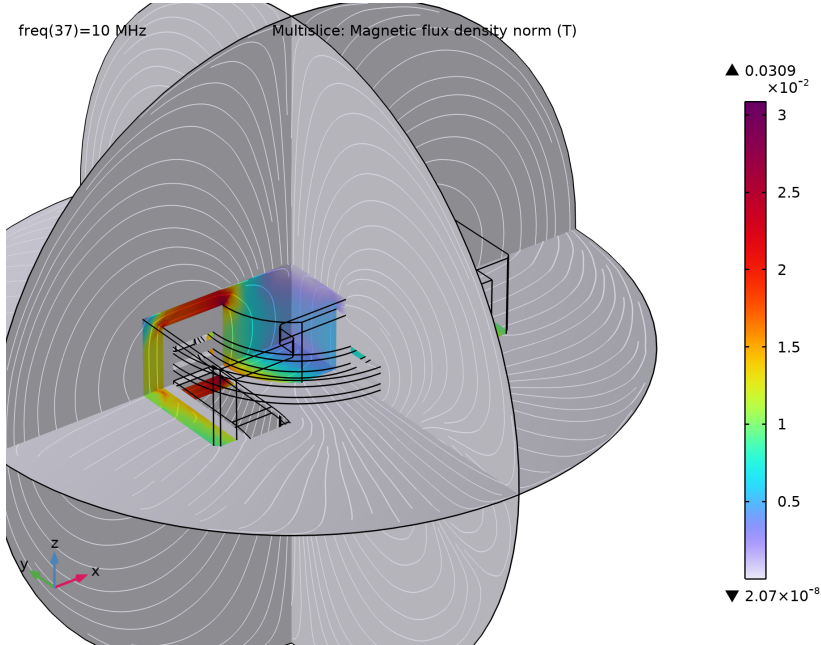





Again check the default plot for any modeling errors. Note that the magnetic flux density inside the copper winding is not computed as this domain was excluded.



Plot the surface current distribution at the lowest frequency solved for. This frequency is below resonance and the device is of an inductive nature.

Datasets

- 1 In the Model Builder under Results>Datasets, right-click Study 2/Solution 3  and choose Duplicate .
- 2 Right-click Study 2/Solution 3 (6)  and choose Selection.

-  Study 1/Solution 1 (1) (sol1)
-  Study 1/Solution Store 1 (sol2)
- >  Study 1/Solution 1 (3) (sol1)
- >  Study 1/Solution 1 (4) (sol1)
-  Study 2/Solution 3 (5) (sol3)
- ▼  Study 2/Solution 3 (6) (sol3)

 Selection

- 3 Go to the Settings window for Selection. Under Geometric Entity Selection from the Geometric entity level list, choose Boundary.
- 4 From the Selection list, choose Conductor Boundaries.

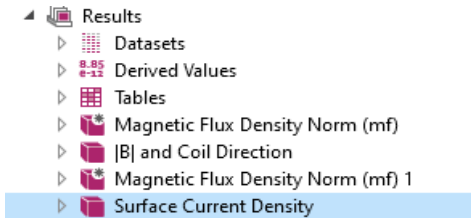

Surface Current Density

- 1 In the Results toolbar click 3D Plot Group . In the Settings window, type Surface Current Density in the Label text field.

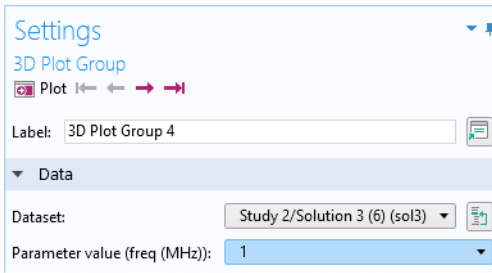

- 2 Go to the Settings window for 3D Plot Group. Under Data from the Dataset list, choose Study 2/Solution 3 (6).
- 3 From the Parameter value (freq (MHz)) list, choose 1.



- 4 Right-click Surface Current Density  and choose Surface .
- 5 Go to the Settings window for Surface. In the upper-right corner of the Expression section, click Replace Expression .

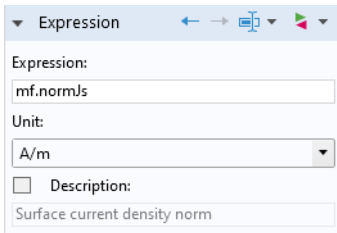

- 6 From the menu, choose Model>Component 1>Magnetic Fields>Currents and charge>mf.normJs - Surface current density norm (when you know the variable

name, as in this exercise, you can also enter `mf.normJs` directly in the Expression text field).

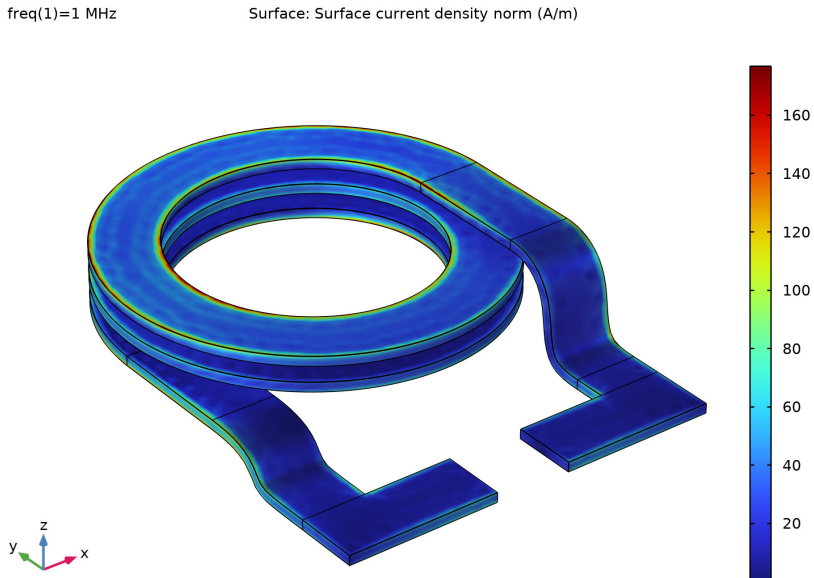

7 Click the Plot  button.

The plot shows the surface current distribution and should match this figure.



Change to the highest frequency solved for and compare the results. Finish the modeling session by plotting the real and imaginary parts of the coil impedance.

Coil Impedance

- 1 In the Results toolbar click 1D Plot Group .
- 2 In the Settings window for 1D Plot Group, type Coil Impedance in the Label text field.
- 3 Locate the Data section, select Study 2/Solution 3 (5) from the Dataset list.
- 4 Locate the Plot Settings section, select the Two y-axes check box.
- 5 Right-click Coil Impedance and choose Global .

- 6 Go to the Settings window for Global. Under y-Axis Data in the Expression column, enter `real(mf.Zport_1)`. In the Description column, enter Real part of impedance.

y-Axis Data		
Expression	Unit	Description
<code>real(mf.Zport_1)</code>	Ω	Real part of impedance

Note: In general, you can click the Replace Expression  to see what variables are available in the predefined lists. In this case, you can enter the information directly into the table.

- 7 Right-click Coil Impedance and choose Global  again to add a plot for the imaginary part of impedance.
- 8 Go to the Settings window for Global. Under y-Axis, select the Plot on secondary y axis check box.
- 9 Under y-Axis Data in the Expression column, enter `imag(mf.Zport_1)`. In the Description column, enter Imaginary part of impedance.

y-Axis		
<input checked="" type="checkbox"/> Plot on secondary y-axis		
y-Axis Data		
Expression	Unit	Description
<code>imag(mf.Zport_1)</code>	Ω	Imaginary part of impedance

10 Click the Plot  button.

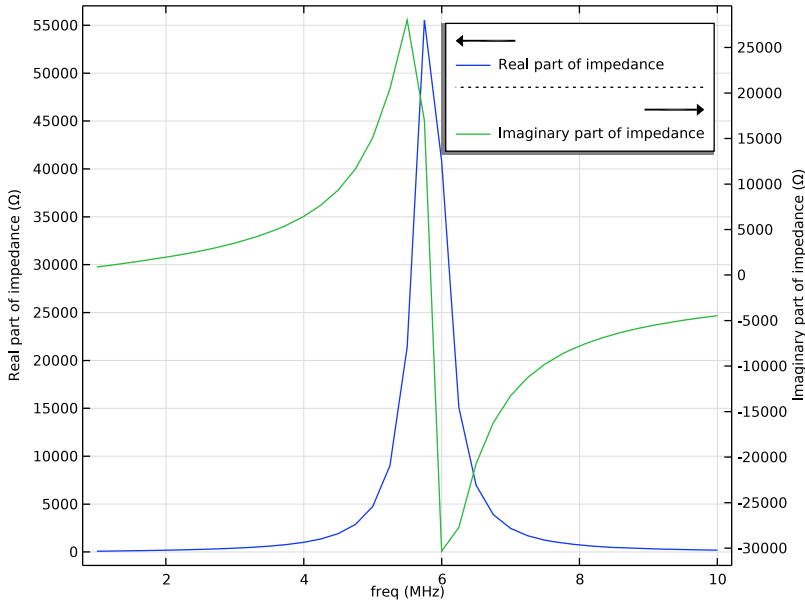

The real (resistive) part of the coil impedance peaks when passing through the resonance frequency. The imaginary (reactive) part of the coil impedance changes sign when passing through the resonance frequency, going from inductive to capacitive.

The resistive part of the coil impedance peaks at the resonance frequency. The reactive part of the coil impedance approaches the one given by the static inductance value at low frequency. With increasing frequency, the quantity increases and then changes sign at the resonance. This happens since the inductor is entering a capacitive regime where the net current is dominated by displacement currents flowing perpendicularly to the coil windings.

As a final step, pick one of the plots to use as a model thumbnail. This selects a nice-looking 3D figure for the graphics window.

- 1 In the Model Builder under Results click **|B|** and Coil Direction .
- 2 Click the Root node (the first node in the model tree). In the Settings window for Root under Presentation>Thumbnail, click Set from Graphics Window.

Make adjustments to the image in the Graphics window using the toolbar buttons until the image is one that is suitable to your purposes.

Tutorial 3: Electrical Heating in a Busbar

This tutorial demonstrates the use of multiphysics modeling in COMSOL Multiphysics with the AC/DC Module. You will learn how to use one of the many preconfigured multiphysics combinations.

The model that you are about to create analyzes a busbar designed to conduct a high amount of direct current in an industrial setting (see picture below). The current conducted in the busbar, from bolt 1 to bolts 2a and 2b, produces heat due to the resistive losses, a phenomenon referred to as Joule heating. The busbar is made of copper, while the bolts are made of a titanium alloy. Busbar bolts are usually made of steel, but in this example, we will assume a highly corrosive environment. Therefore, a titanium alloy was chosen.

Under normal operational conditions, the currents are predominantly conducted through the copper. This example, however, illustrates the effects of an unwanted electrical loading of the busbar through the bolts. The fact that there are different materials is important because titanium has a lower electrical conductivity than copper and will be subjected to a higher current density.

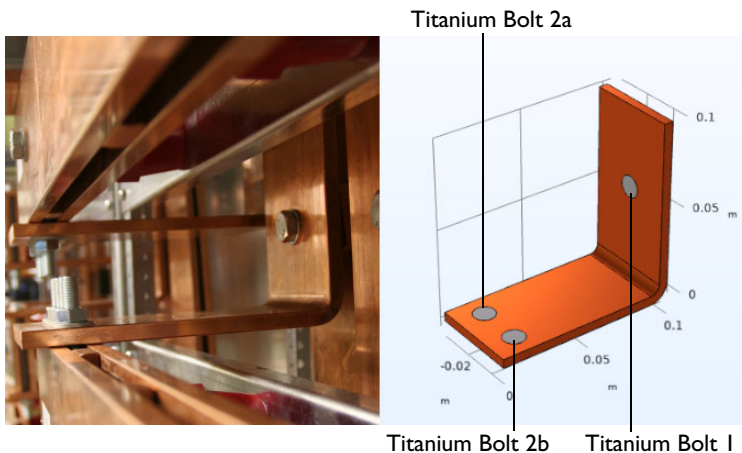



The goal of your simulation is to precisely calculate how much the busbar heats up. The Joule heating effect is described by conservation laws for electric current and energy. Once solved for, the two conservation laws give the temperature and electric field, respectively. All surfaces, except the bolt contact surfaces, are cooled by natural convection in the air surrounding the busbar. You can assume that the exposed parts of the bolt do not contribute to the cooling or heating of the device. The electric current flowing through the upper-right vertical bolt surface is 160 A and the potential at the two horizontal surfaces of the lower bolts is 0 V.







Model Wizard

Note: These instructions are for the user interface on Windows but apply, with minor differences, also to Linux and Mac.

- 1 To start the software, double-click the COMSOL icon on the desktop. When the software opens, you can choose to use the Model Wizard to create a new COMSOL Multiphysics model or Blank Model to create one manually. For this tutorial, click the Model Wizard button.

If COMSOL Multiphysics is already open, you can start the Model Wizard by selecting New  from the File menu and then click Model Wizard .



The Model Wizard guides you through the first steps of setting up a model. The next window lets you select the dimension of the modeling space.

- 2 In the Space Dimension window click 3D .
- 3 In the Select Physics tree under AC/DC, expand Electromagnetic Heating  and select Joule Heating .
- 4 Click Add then click Study .
- 5 In the Select Study window under General Studies, click Stationary .
- 6 Click Done .

Importing the Geometry

The next step is to create your geometry, which also can be imported from an external program. COMSOL Multiphysics supports a multitude of CAD programs and file formats. In this example, import the geometry sequence from the COMSOL Multiphysics file format (.mph).

Note: The location of the files used in this exercise varies based on your installation. For example, if the installation is on your hard drive, the file path might be similar to C:\Program Files\COMSOL\COMSOL62\Multiphysics\applications\.

- 1 In the Geometry toolbar, click Insert Sequence .
- 2 Then navigate to your COMSOL Multiphysics installation folder, locate the subfolder ACDC_Module\Introductory_Electric_Currents, and double-click the file busbar_terminal_geom_sequence.mph.
- 3 In the Geometry toolbar, click Build All .

Global Definitions - Parameters

It is good modeling practice to gather constants and parameters in one place so that you can change them easily. Using parameters will also improve the readability of your input data.

The following parameters will be defined: the maximum element size m_h , heat transfer coefficient h_{tc} , and terminal current I .

- 1 In the Model Builder Window, under Global Definitions, select Parameters 1 P_1 .
- 2 In the Settings window for Parameters, locate the Parameters section. You will find some parameters in the table. The parameters are used for building the geometry and they are imported together with the geometry sequence.

In the table, add the following parameters:

NAME	EXPRESSION	VALUE	DESCRIPTION
m_h	3[mm]	0.003 m	Maximum element size
h_{tc}	5[W/m ² /K]	5 W/(m ² ·K)	Heat transfer coefficient
I	160[A]	160 A	Terminal current

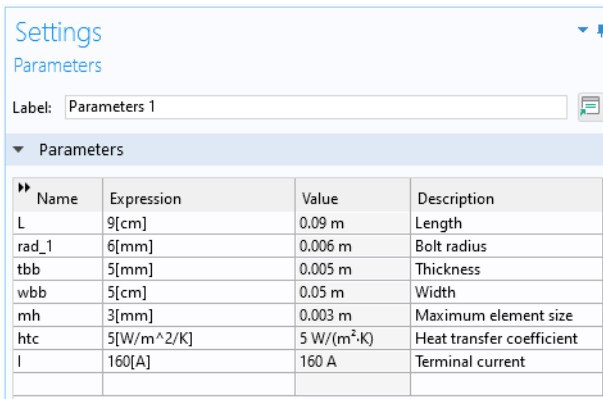

The third column in the table is filled out automatically. The final parameter table is shown below:



Name	Expression	Value	Description
L	9[cm]	0.09 m	Length
rad_1	6[mm]	0.006 m	Bolt radius
tbb	5[mm]	0.005 m	Thickness
wbb	5[cm]	0.05 m	Width
m_h	3[mm]	0.003 m	Maximum element size
h_{tc}	5[W/m ² /K]	5 W/(m ² ·K)	Heat transfer coefficient
I	160[A]	160 A	Terminal current

Materials

Add Material

- 1 In the Home toolbar, click Add Material  to open the Add Material window. Go to the Add Material window.
- 2 In the tree, select Built-in>Copper. Click Add to Component in the window toolbar.
- 3 In the tree, select Built-in>Titanium beta-21S. Click Add to Component in the window toolbar.
- 4 In the Home toolbar, click Add Material  to close the Add Material window.

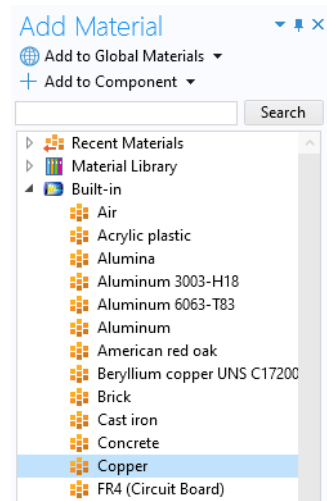

Materials

- 1 Select Titanium beta-21S (mat2) and select Domains 2–7 only.
- 2 In the Settings window for Material, locate the Geometric Entity Selection section.
- 3 Click Create Selection .
- 4 In the Create Selection dialog box, type Ti bolts in the Selection name text field.
- 5 Click OK.

Heat Transfer in Solids (ht)

- 1 In the Model Builder window, under Component 1 (comp1) right-click Heat Transfer in Solids (ht) and choose Heat Flux.
- 2 In the Settings window for Heat Flux, locate the Boundary Selection section.
- 3 Select All boundaries except for 8, 15, and 43.

Note: There are many ways to select geometric entities. When you know the boundaries to exclude, such as in this exercise, you can select all boundaries and then remove the corresponding boundaries. In this example, select 8, 15, 43 in the Selection window and click Remove from Selection — . You will also notice that there are some internal boundaries (such as 9-11) that are marked as ‘Not applicable’. For more information about selecting geometric entities in the Graphics window, see the *COMSOL Multiphysics Reference Manual*.

- 4 Locate the Heat Flux section. From the Flux type list, choose Convective heat flux. In the h text field, type htc.

Heat Flux

Flux type:
Convective heat flux

Heat transfer coefficient:
User defined

Heat transfer coefficient:
h htc W/(m²·K)

External temperature:
T_{ext} User defined

293.15[K] K

Electric Currents (ec)

In the Model Builder window, under Component 1 (comp1) click Electric Currents (ec).

Terminal 1

- 1 In the Physics toolbar, click Boundaries  and choose Terminal.
- 2 Select Boundary 43 only.
- 3 In the Settings window for Terminal, locate the Terminal section.
- 4 In the I0 text field, type I.

The Settings of Terminal 1 are shown in the figure to the right. Next, make similar settings for Terminal 2.

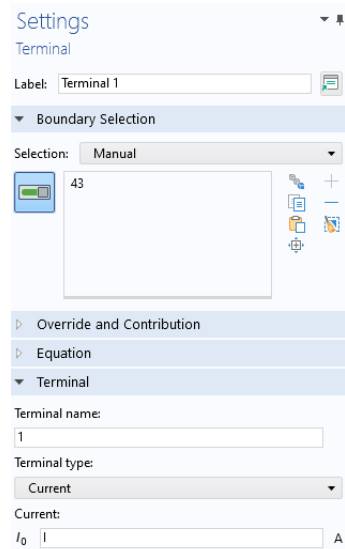



Terminal 2

- 1 In the Physics toolbar, click Boundaries  and choose Terminal.
- 2 Select Boundaries 8 and 15 only.
- 3 In the Settings window for Terminal, locate the Terminal section.
- 4 From the Terminal type list, choose Voltage.
- 5 In the V0 text field, type 0.

Mesh

The simplest way to mesh is to create an unstructured tetrahedral mesh, which is perfect for this model. A physics-controlled mesh is created by default. In most cases, it is possible to skip to the Study node and just solve the model. For this exercise, the settings are investigated in order to parameterize the mesh settings.

- 1 In the Mesh toolbar, click Free Tetrahedral .
- 2 In the Model Builder window, click Size.
- 3 In the Settings window for Size, locate the Element Size section.
- 4 Click the Custom button. Locate the Element Size Parameters section. In the Maximum element size text field, type mh.
- 5 In the Minimum element size text field, type mh-mh/3.
- 6 In the Curvature factor text field, type 0.2.
- 7 In the mesh settings window, click Build All .

The mesh is shown below.

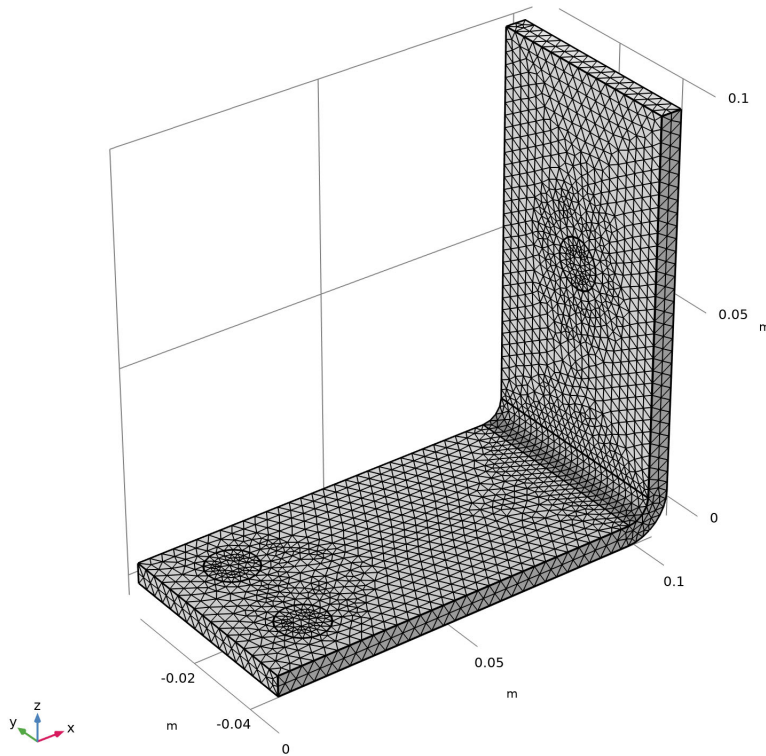

Study and Results

Study

In the Home toolbar, click Compute . The Study node automatically defines a solution sequence for the simulation based on the selected physics and study type. In this case, the simulation only takes a few seconds to solve. During the solution process, two Convergence plots are generated and are available from tabs next to the Graphics window. These plots show the convergence progress of the different solver algorithms engaged by the Study. Once it is finished, several default plots will show under the Results node.

Temperature (ht)

Select the Temperature (ht) plot group under the Results node. Click the Zoom Extents  button in the Graphics toolbar.

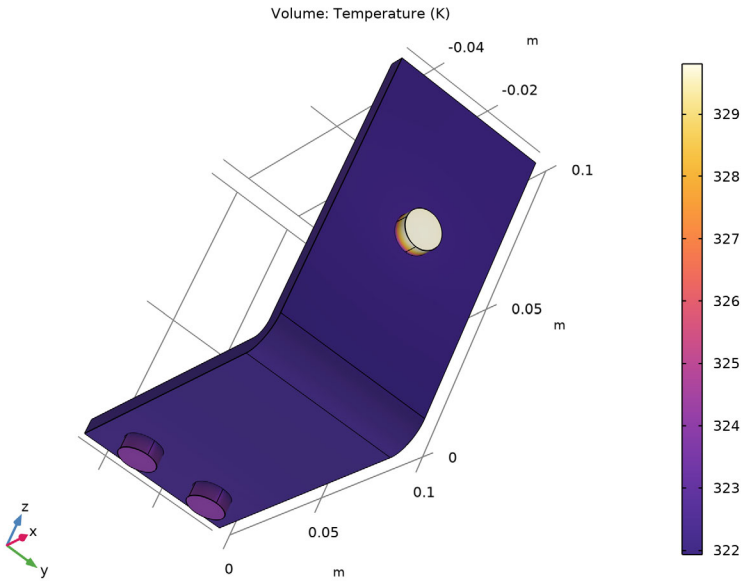

Volume

- 1 In the Model Builder window, expand the Temperature (ht) node, then click Volume.
- 2 In the Settings window for Volume, click to expand the Range section.
- 3 Select the Manual color range check box.
- 4 In the Maximum text field, type 324.
- 5 In the Temperature (ht) toolbar, click Plot .

6 Click the Zoom Extents  button in the Graphics toolbar.

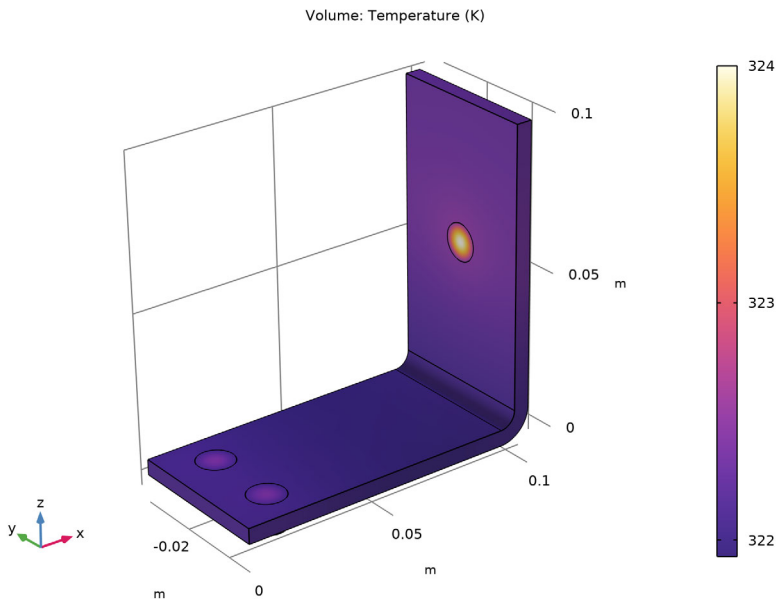

Note: The temperature distribution is laterally symmetric with a vertical mirror plane running between the two lower titanium bolts and cutting through the center of the upper bolt. In this case, the model does not require much computing power and you can model the entire geometry. For more complex models, you can consider using symmetries to reduce the computational requirements.

Current Density

- 1 In the Home toolbar, click Add Plot Group and choose 3D Plot Group.
- 2 In the Settings window for 3D Plot Group, type Current Density in the Label text field.
- 3 Right-click Current Density and choose Surface.
- 4 In the Settings window for Surface, click Replace Expression in the upper-right corner of the Expression section. From the menu, choose Component 1 (comp1)>Electric Currents>Currents and charge>ec.normJ - Current density norm - A/m². You can also type ec.normJ in the Expression field when you know the variable name or, alternatively, use the auto completion functionality by typing norm and then pressing Ctrl+Space to get a variable name suggestion.
- 5 Click Plot  to display it in the Graphics window. As it can be seen, the plot is almost uniform in color due to the high current density at the contact edges with the bolts. The next step is to manually change the color table range to visualize the current density distribution. Click to expand the Range section. Select the Manual color range check box.
- 6 In the Maximum text field, type 1e6.

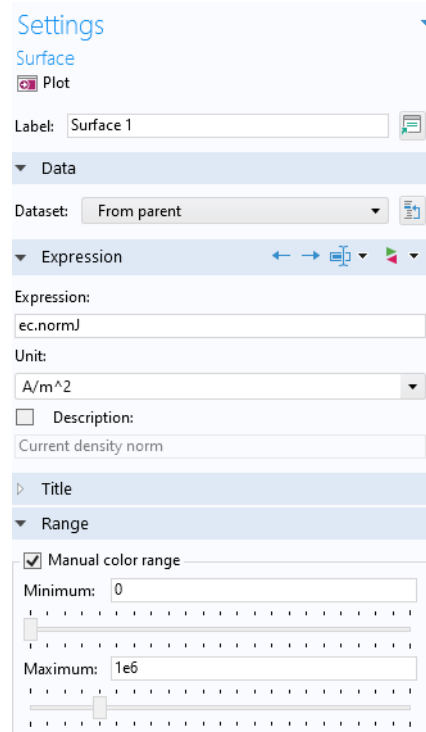

- 7 In the Current Density toolbar, click Plot . The resulting plot shows that the current takes the shortest path in the 90-degree bend in the busbar. Notice that the edges of the busbar outside of the bolts are hardly carrying any current.

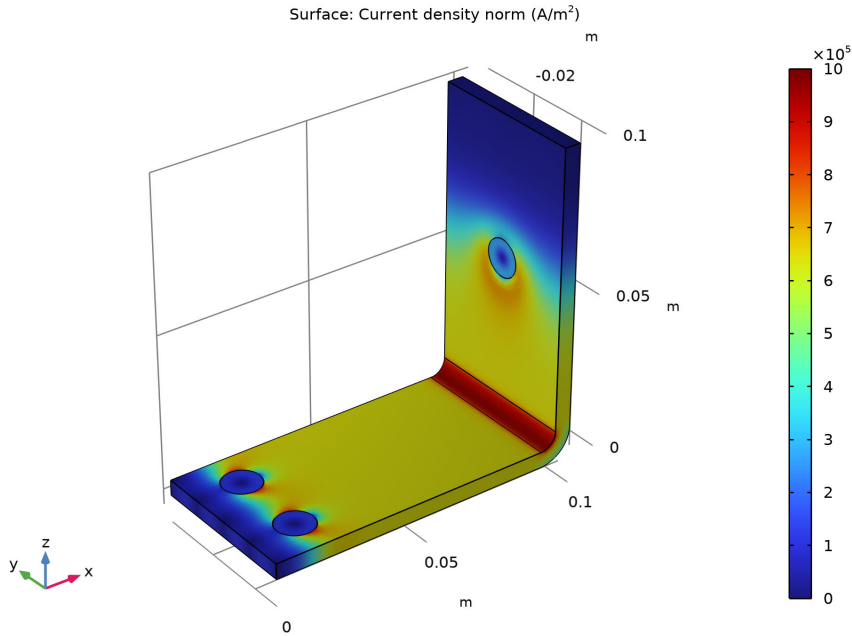

Temperature (ht)

- 1 In the Model Builder window, under Results click Temperature (ht).
- 2 In the Temperature (ht) toolbar, click More Plots and choose Max/Min Volume.
- 3 In the Settings window for Max/Min Volume, click Replace Expression in the upper-right corner of the Expression section. From the menu, choose Component 1 (comp1)>Heat Transfer in Solids>Temperature>T - Temperature - K. You can also search for Temperature in the search field above the tree of postprocessing variables or manually enter T.

4 In the Temperature (ht) toolbar, click Plot .

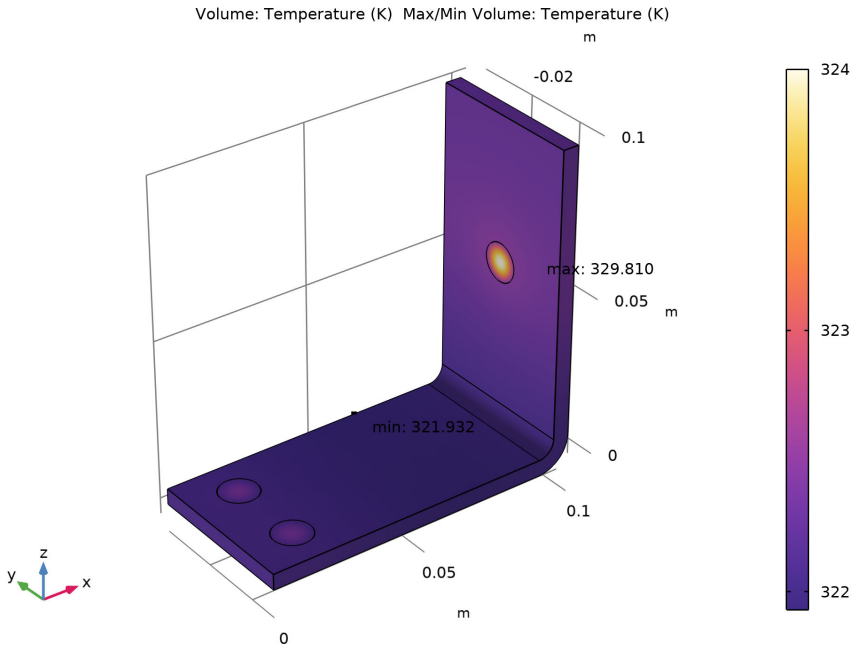

The maximum and minimum values may vary a bit depending on the version you are running. For a finer mesh the results will be the same regardless of version.

As an alternative to the method of plotting the maximum and minimum values described above, you can use the Derived Values node or an Evaluation Group for a pure numerical output. The following steps show how to use Derived Values.

- 1 In the Results section of the model tree, right-click the Derived Values node and select Maximum > Volume Maximum.
- 2 In the Settings window for Volume Maximum, under Selection, choose All domains.
- 3 In the first row of the Expression table, enter τ (unless it is automatically filled out) for the temperature and click Evaluate at the top of the Settings window.

The Settings of the Volume Maximum is shown as follows.

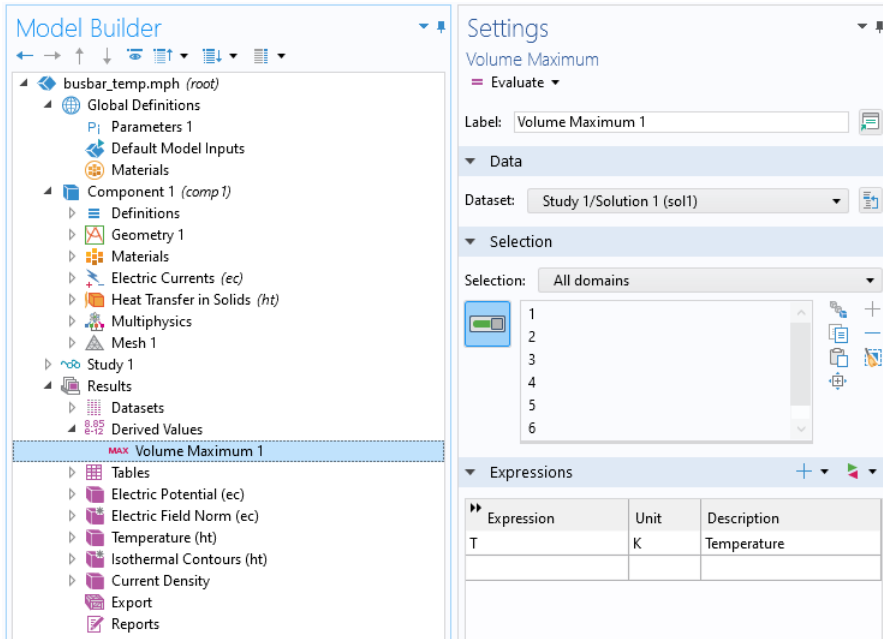

Click Evaluate = button and a table will show up and display the value of the maximum temperature.

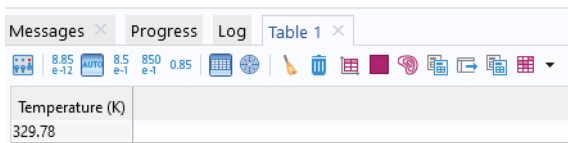

This concludes this introduction.