



# RF Module

User's Guide

# RF Module User's Guide

© 1998–2022 COMSOL

Protected by patents listed on [www.comsol.com/patents](http://www.comsol.com/patents), or see Help>About COMSOL Multiphysics on the File menu in the COMSOL Desktop for less detailed lists of U.S. Patents that may apply. Patents pending.

This Documentation and the Programs described herein are furnished under the COMSOL Software License Agreement ([www.comsol.com/sla](http://www.comsol.com/sla)) and may be used or copied only under the terms of the license agreement.

COMSOL, the COMSOL logo, COMSOL Multiphysics, COMSOL Desktop, COMSOL Compiler, COMSOL Server, and LiveLink are either registered trademarks or trademarks of COMSOL AB. All other trademarks are the property of their respective owners, and COMSOL AB and its subsidiaries and products are not affiliated with, endorsed by, sponsored by, or supported by those trademark owners. For a list of such trademark owners, see [www.comsol.com/trademarks](http://www.comsol.com/trademarks).

Version: COMSOL 6.1

## Contact Information

Visit the Contact COMSOL page at [www.comsol.com/contact](http://www.comsol.com/contact) to submit general inquiries or search for an address and phone number. You can also visit the Worldwide Sales Offices page at [www.comsol.com/contact/offices](http://www.comsol.com/contact/offices) for address and contact information.

If you need to contact Support, an online request form is located on the COMSOL Access page at [www.comsol.com/support/case](http://www.comsol.com/support/case). Other useful links include:

- Support Center: [www.comsol.com/support](http://www.comsol.com/support)
- Product Download: [www.comsol.com/product-download](http://www.comsol.com/product-download)
- Product Updates: [www.comsol.com/support/updates](http://www.comsol.com/support/updates)
- COMSOL Blog: [www.comsol.com/blogs](http://www.comsol.com/blogs)
- Discussion Forum: [www.comsol.com/forum](http://www.comsol.com/forum)
- Events: [www.comsol.com/events](http://www.comsol.com/events)
- COMSOL Video Gallery: [www.comsol.com/videos](http://www.comsol.com/videos)
- Support Knowledge Base: [www.comsol.com/support/knowledgebase](http://www.comsol.com/support/knowledgebase)

Part number: CM021001

# C o n t e n t s

## Chapter 1: Introduction

<b>About the RF Module</b>	<b>12</b>
What Can the RF Module Do? . . . . .	12
What Problems Can You Solve? . . . . .	13
The RF Module Physics Interface Guide . . . . .	14
Common Physics Interface and Feature Settings and Nodes . . . . .	16
Selecting the Study Type . . . . .	17
The RF Module Modeling Process . . . . .	18
Where Do I Access the Documentation and Application Libraries? . . . . .	19
<b>Overview of the User's Guide</b>	<b>23</b>

## Chapter 2: RF Modeling

<b>Preparing for RF Modeling</b>	<b>27</b>
<b>Simplifying Geometries</b>	<b>28</b>
2D Models . . . . .	28
3D Models . . . . .	30
Using Efficient Boundary Conditions . . . . .	31
Applying Electromagnetic Sources . . . . .	31
Meshing and Solving. . . . .	32
<b>Periodic Boundary Conditions</b>	<b>34</b>
<b>Scattered Field Formulation</b>	<b>36</b>
<b>Modeling with Far-Field Calculations</b>	<b>38</b>
Far-Field Support in the Electromagnetic Waves, Frequency Domain Interface. . . . .	38
The Radiation Pattern Plots . . . . .	39

<b>S-Parameters and Ports</b>	<b>46</b>
S-Parameters in Terms of Voltage and Electric Field . . . . .	46
S-Parameter Calculations. . . . .	47
S-Parameter Variables . . . . .	47
Port Sweeps/Manual Terminal Sweeps and Touchstone Export . . . . .	47
<b>Lumped Ports with Voltage Input</b>	<b>49</b>
About Lumped Ports . . . . .	49
Lumped Port Parameters. . . . .	50
Lumped Ports in the RF Module . . . . .	51
<b>Jones Vectors and Polarization Plots</b>	<b>53</b>
Jones Vectors for Polarization Analysis . . . . .	53
Polarization Plots. . . . .	54
Jones Vector Variables. . . . .	54
<b>Lossy Eigenvalue Calculations</b>	<b>56</b>
Eigenfrequency Analysis . . . . .	56
Mode Analysis and Boundary Mode Analysis . . . . .	58
<b>Connecting to Electrical Circuits</b>	<b>61</b>
About Connecting Electrical Circuits to Physics Interfaces . . . . .	61
Connecting Electrical Circuits Using Predefined Couplings . . . . .	62
Connecting Electrical Circuits by User-Defined Couplings . . . . .	62
Solving. . . . .	64
Postprocessing. . . . .	64
<b>SPICE Import and Export</b>	<b>65</b>
SPICE Import . . . . .	65
SPICE Export . . . . .	66
Reference . . . . .	66
<b>Reduced-Order Modeling</b>	<b>67</b>
Adaptive Frequency Sweep Using Asymptotic Waveform Evaluation (AWE) Method . . . . .	67
Frequency Domain, Modal Method . . . . .	69

<b>Part Libraries</b>	<b>71</b>
<b>Material Libraries</b>	<b>72</b>

## Chapter 3: Electromagnetics Theory

<b>Maxwell's Equations</b>	<b>74</b>
Maxwell's Equations . . . . .	74
Constitutive Relations . . . . .	75
Boundary Conditions . . . . .	76
Potentials . . . . .	77
Electromagnetic Energy . . . . .	78
Material Properties . . . . .	79
Phasors . . . . .	81
<b>Special Calculations</b>	<b>82</b>
S-Parameter Calculations . . . . .	82
Far-Field Calculations Theory . . . . .	85
References . . . . .	86
<b>Electromagnetic Quantities</b>	<b>87</b>

## Chapter 4: Radio Frequency Interfaces

<b>The Electromagnetic Waves, Frequency Domain Interface</b>	<b>90</b>
Domain, Boundary, Edge, Point, and Pair Nodes for the Electromagnetic Waves, Frequency Domain Interface . . . . .	101
Wave Equation, Electric . . . . .	104
Divergence Constraint . . . . .	110
Initial Values . . . . .	110
External Current Density . . . . .	110
Far-Field Domain . . . . .	111
Far-Field Calculation . . . . .	111
Specific Absorption Rate . . . . .	113
Perfect Electric Conductor . . . . .	113

Perfect Magnetic Conductor . . . . .	114
Port. . . . .	115
Integration Line for Current . . . . .	126
Integration Line for Voltage . . . . .	126
Ground . . . . .	126
Electric Potential . . . . .	127
Circular Port Reference Axis . . . . .	127
Diffraction Order . . . . .	128
Orthogonal Polarization . . . . .	130
Periodic Port Reference Point . . . . .	131
Lumped Port . . . . .	132
Lumped Element . . . . .	137
Uniform Element . . . . .	139
Electric Field . . . . .	139
Magnetic Field . . . . .	140
Scattering Boundary Condition . . . . .	140
Reference Point . . . . .	145
Symmetry Axis Reference Point . . . . .	145
Impedance Boundary Condition . . . . .	146
Surface Current Density . . . . .	148
Surface Magnetic Current Density . . . . .	148
Surface Roughness . . . . .	149
Transition Boundary Condition . . . . .	150
Layered Transition Boundary Condition . . . . .	152
Layered Impedance Boundary Condition . . . . .	155
Periodic Condition . . . . .	157
Magnetic Current . . . . .	159
Two-Port Network . . . . .	159
Two-Port Network Port . . . . .	160
Three-Port Network . . . . .	161
Three-Port Network Port . . . . .	162
Four-Port Network . . . . .	162
Four-Port Network Port . . . . .	163
Mixed Mode S-Parameters . . . . .	163
Symmetry Plane . . . . .	164
Edge Current . . . . .	165
Electric Point Dipole . . . . .	165
Magnetic Point Dipole . . . . .	166

Line Current (Out-of-Plane) . . . . .	166
Archie's Law . . . . .	166
Effective Medium . . . . .	167
<b>The Electromagnetic Waves, Transient Interface</b>	<b>169</b>
Domain, Boundary, Edge, Point, and Pair Nodes for the Electromagnetic Waves, Transient Interface . . . . .	170
Wave Equation, Electric . . . . .	172
Initial Values . . . . .	175
Drude–Lorentz Polarization. . . . .	176
<b>The Transmission Line Interface</b>	<b>177</b>
Domain, Boundary, Edge, Point, and Pair Nodes for the Transmission Line Equation Interface . . . . .	178
Transmission Line Equation . . . . .	179
Initial Values . . . . .	180
Absorbing Boundary . . . . .	180
Incoming Wave . . . . .	180
Open Circuit . . . . .	181
Terminating Impedance . . . . .	181
Short Circuit . . . . .	182
Lumped Port . . . . .	182
<b>The Electromagnetic Waves, Time Explicit Interface</b>	<b>184</b>
Domain, Boundary, and Pair Nodes for the Electromagnetic Waves, Time Explicit Interface . . . . .	185
Wave Equations . . . . .	186
Initial Values . . . . .	189
Electric Current Density . . . . .	189
Magnetic Current Density . . . . .	190
Electric Field . . . . .	190
Perfect Electric Conductor . . . . .	190
Magnetic Field . . . . .	191
Perfect Magnetic Conductor . . . . .	191
Surface Current Density . . . . .	191
Scattering Boundary Condition . . . . .	192
Flux/Source . . . . .	192
Background Field . . . . .	193

Far-Field Domain . . . . .	194
Far-Field Calculation . . . . .	194
<b>The Electromagnetic Waves, Asymptotic Scattering Interface</b>	<b>196</b>
Asymptotic Scattering . . . . .	199
Far-Field Calculation . . . . .	199
Initial Values . . . . .	199
<b>The Electromagnetic Waves, Boundary Elements Interface</b>	<b>200</b>
Domain, Boundary, Edge, Point, and Pair Nodes for the Electromagnetic Waves, Boundary Elements Interface . . . . .	209
Wave Equation, Electric . . . . .	210
Initial Values . . . . .	211
Far-Field Calculation . . . . .	211
Electric Field Coupling . . . . .	211
Lumped Port . . . . .	212
<b>The Electromagnetic Waves, FEM-BEM Interface</b>	<b>214</b>
<b>Theory for the Electromagnetic Waves Interfaces</b>	<b>217</b>
Introduction to the Physics Interface Equations . . . . .	217
Frequency Domain Equation . . . . .	218
Time Domain Equation . . . . .	224
Curl Elements . . . . .	226
Eigenfrequency Calculations. . . . .	226
Gaussian Beams as Background Fields and Input Fields. . . . .	227
Linearly Polarized Plane Wave as Background Field in 2D Axisymmetry . . . . .	229
Periodic Port Mode Fields . . . . .	230
Effective Material Properties in Effective Media and Mixtures . . . . .	231
Effective Conductivity in Effective Media and Mixtures. . . . .	231
Effective Relative Permittivity in Effective Media and Mixtures . . . . .	232
Effective Relative Permeability in Effective Media and Mixtures . . . . .	233
Archie's Law Theory . . . . .	234
Reference for Archie's Law . . . . .	235
<b>Theory for the Transmission Line Interface</b>	<b>236</b>
Introduction to Transmission Line Theory . . . . .	236



Theory for the Transmission Line Boundary Conditions . . . . .	237
--	-----

**Theory for the Electromagnetic Waves, Time Explicit**

<b>Interface</b>	<b>240</b>
The Equations . . . . .	240
In-Plane E Field or In-Plane H Field . . . . .	244
Fluxes as Dirichlet Boundary Conditions . . . . .	245
Absorbing Layers . . . . .	246

## Chapter 5: AC/DC Interfaces

<b>The Electrical Circuit Interface</b>	<b>250</b>
Ground Node . . . . .	252
Voltmeter . . . . .	252
Ampère Meter. . . . .	252
Resistor . . . . .	252
Capacitor. . . . .	253
Inductor . . . . .	253
Voltage Source . . . . .	253
Current Source . . . . .	254
Voltage-Controlled Voltage Source . . . . .	255
Voltage-Controlled Current Source. . . . .	256
Current-Controlled Voltage Source. . . . .	256
Current-Controlled Current Source . . . . .	257
Switch . . . . .	257
Subcircuit Definition . . . . .	258
Subcircuit Instance . . . . .	259
NPN BJT and PNP BJT. . . . .	259
n-Channel MOSFET and p-Channel MOSFET . . . . .	260
Mutual Inductance . . . . .	260
Transformer . . . . .	261
Diode . . . . .	261
External I vs. U . . . . .	262
External U vs. I . . . . .	263
External I-Terminal . . . . .	264
SPICE Circuit Import . . . . .	265

SPICE Circuit Export . . . . .	265
<b>Theory for the Electrical Circuit Interface</b>	<b>267</b>
Electric Circuit Modeling and the Semiconductor Device Models. . . . .	267
Bipolar Transistors . . . . .	268
MOSFET Transistors . . . . .	271
Diode . . . . .	274
Reference for the Electrical Circuit Interface . . . . .	276

## Chapter 6: Heat Transfer Interfaces

<b>The Microwave Heating Interface</b>	<b>278</b>
Electromagnetic Heating . . . . .	281

## Chapter 7: Glossary

<b>Glossary of Terms</b>	<b>286</b>
<b>Index</b>	<b>289</b>

# Introduction

This guide describes the RF Module, an optional add-on package for COMSOL Multiphysics® with customized physics interfaces and functionality optimized for the analysis of electromagnetic waves.

This chapter introduces you to the capabilities of this module. A summary of the physics interfaces and where you can find documentation and model examples is also included. The last section is a brief overview with links to each chapter in this guide.

- [About the RF Module](#)
- [Overview of the User's Guide](#)

# About the RF Module

In this section:

- [What Can the RF Module Do?](#)
- [What Problems Can You Solve?](#)
- [The RF Module Physics Interface Guide](#)
- [Common Physics Interface and Feature Settings and Nodes](#)
- [Selecting the Study Type](#)
- [The RF Module Modeling Process](#)
- [Where Do I Access the Documentation and Application Libraries?](#)



The Physics Interfaces and Building a COMSOL Multiphysics Model in the *COMSOL Multiphysics Reference Manual*

---

## *What Can the RF Module Do?*

---

The RF Module solves problems in the general field of electromagnetic waves, such as RF and microwave applications, optics, and photonics. The underlying equations for electromagnetics are automatically available in all of the physics interfaces — a feature unique to COMSOL Multiphysics. This also makes nonstandard modeling easily accessible.

The module is useful for component design in virtually all areas where you find electromagnetic waves, such as:

- Antennas
- Filters, couplers, and power dividers
- Planar circuits and passive devices
- RF interconnects and packages
- Waveguides and cavity resonators
- Frequency-selective surfaces
- Metamaterials

The physics interfaces cover the following types of electromagnetics field simulations and handle time-harmonic, time-dependent, and eigenfrequency/eigenmode problems:

- In-plane, axisymmetric, and full 3D electromagnetic wave propagation
- Full vector mode analysis in 2D and 3D

Material properties include inhomogeneous and fully anisotropic materials, media with gains or losses, and complex-valued material properties. In addition to the standard postprocessing features, the module supports direct computation of S-parameters and far-field radiation patterns. You can add ports with a wave excitation with specified power level and mode type, and add PMLs (perfectly matched layers) to simulate electromagnetic waves that propagate into an unbounded domain. For time-harmonic simulations, you can use the scattered wave or the total wave.

Using the multiphysics capabilities of COMSOL Multiphysics you can couple simulations with heat transfer, structural mechanics, fluid-flow formulations, and other physical phenomena.

This module also has interfaces for circuit modeling, a SPICE interface, and support for importing ECAD drawings.

### *What Problems Can You Solve?*

---

#### **QUASISTATIC AND HIGH FREQUENCY MODELING**

One major difference between quasistatic and high-frequency modeling is that the formulations depend on the *electrical size* of the structure. This dimensionless measure is the ratio between the largest distance between two points in the structure divided by the wavelength of the electromagnetic fields.

For simulations of structures with an electrical size in the range up to  $1/10$ , quasi-static formulations are suitable. The physical assumption of these situations is that wave propagation delays are small enough to be neglected. Thus, phase shifts or phase gradients in fields are caused by materials and/or conductor arrangements being inductive or capacitive rather than being caused by propagation delays.

For electrostatic, magnetostatic, and quasi-static electromagnetics, use the AC/DC Module, a COMSOL Multiphysics add-on module for low-frequency electromagnetics.

When propagation delays become important, it is necessary to use the full Maxwell equations for high-frequency electromagnetic waves. They are appropriate for structures of electrical size 1/100 and larger. Thus, an overlapping range exists where you can use both the quasi-static and the full Maxwell physics interfaces.

Independently of the structure size, the module accommodates any case of nonlinear, inhomogeneous, or anisotropic media. It also handles materials with properties that vary as a function of time as well as frequency-dispersive materials.

### *The RF Module Physics Interface Guide*









---





The physics interfaces in this module form a complete set of simulation tools for electromagnetic wave simulations. Add the physics interface and study type when starting to build a new model. You can add physics interfaces and studies to an existing model throughout the design process. In addition to the core physics interfaces included with the basic COMSOL Multiphysics license, the physics interfaces below are included with the RF Module and available in the indicated space dimension. All physics interfaces are available in 2D and 3D. In 2D there are in-plane formulations for problems with a planar symmetry as well as axisymmetric formulations for problems with a cylindrical symmetry. 2D mode analysis of waveguide cross sections with out-of-plane propagation is also supported.



In the *COMSOL Multiphysics Reference Manual*:

- [Studies and Solvers](#)
  - [The Physics Interfaces](#)
  - [Creating a New Model](#)
  - For a list of all the core physics interfaces included with a COMSOL Multiphysics license, see [Physics Interface Guide](#).
-

PHYSICS INTERFACE	ICON	TAG	SPACE DIMENSION	AVAILABLE STUDY TYPE
 <b>AC/DC</b>				
Electrical Circuit		cir	Not space dependent	stationary; frequency domain; time dependent; frequency domain; eigenfrequency
 <b>Heat Transfer</b>				
 <b>Electromagnetic Heating</b>				
Microwave Heating <sup>1</sup>		—	3D, 2D, 2D axisymmetric	frequency-stationary; frequency-transient; frequency-stationary, one-way electromagnetic heating; frequency-transient, one-way electromagnetic heating
 <b>Radio Frequency</b>				
Electromagnetic Waves, Asymptotic Scattering		ewas	3D, 2D	frequency domain
Electromagnetic Waves, Boundary Elements		embe	3D, 2D	frequency domain
Electromagnetic Waves, Frequency Domain		emw	3D, 2D, 2D axisymmetric	adaptive frequency sweep; boundary mode analysis; eigenfrequency; frequency domain; frequency domain, modal; frequency domain, RF adaptive mesh; frequency domain source sweep; mode analysis (2D and 2D axisymmetric models only); TEM boundary mode analysis

PHYSICS INTERFACE	ICON	TAG	SPACE DIMENSION	AVAILABLE STUDY TYPE
Electromagnetic Waves, Time Explicit		ewte	3D, 2D, 2D axisymmetric	time dependent; time dependent with FFT
Electromagnetic Waves, Transient		temw	3D, 2D, 2D axisymmetric	eigenfrequency; time dependent; time dependent, modal; time dependent with FFT
Transmission Line		tl	3D, 2D, 1D	eigenfrequency; frequency domain
Electromagnetic Waves, FEM-BEM <sup>1</sup>			3D, 2D	frequency domain
<sup>1</sup> This physics interface is a predefined multiphysics coupling that automatically adds all the physics interfaces and coupling features required.				

### *Common Physics Interface and Feature Settings and Nodes*

There are several common settings and sections available for the physics interfaces and feature nodes. Some of these sections also have similar settings or are implemented in the same way no matter the physics interface or feature being used. There are also some physics feature nodes that display in COMSOL Multiphysics.

In each module's documentation, only unique or extra information is included; standard information and procedures are centralized in the *COMSOL Multiphysics Reference Manual*.



In the *COMSOL Multiphysics Reference Manual* see [Table 2-4](#) for links to common sections and [Table 2-5](#) to common feature nodes. You can also search for information: press F1 to open the **Help** window or Ctrl+F1 to open the **Documentation** window.



## *Selecting the Study Type*

---

To carry out different kinds of simulations for a given set of parameters in a physics interface, you can select, add, and change the Study Types at almost every stage of modeling.



Studies and Solvers in the *COMSOL Multiphysics Reference Manual*

---

### **COMPARING THE TIME DEPENDENT AND FREQUENCY DOMAIN STUDIES**

When variations in time are present there are two main approaches to represent the time dependence. The most straightforward is to solve the problem by calculating the changes in the solution for each time step; that is, solving using the Time Dependent study (available with the Electromagnetic Waves, Transient interface). However, this approach can be time consuming if small time steps are necessary for the desired accuracy. It is necessary when the inputs are transients like turn-on and turn-off sequences.

However, if the Frequency Domain study available with the Electromagnetic Waves, Frequency Domain interface is used, this allows you to efficiently simplify and assume that all variations in time occur as sinusoidal signals. Then the problem is time-harmonic and in the frequency domain. Thus you can formulate it as a stationary problem with complex-valued solutions. The complex value represents both the amplitude and the phase of the field, while the frequency is specified as a scalar model input, usually provided by the solver. This approach is useful because, combined with Fourier analysis, it applies to all periodic signals with the exception of nonlinear problems. Examples of typical frequency domain simulations are wave-propagation problems like waveguides and antennas.

For nonlinear problems you can apply a Frequency Domain study after a linearization of the problem, which assumes that the distortion of the sinusoidal signal is small.

Use a Time Dependent study when the nonlinear influence is strong, or if you are interested in the harmonic distortion of a sine signal. It can also be more efficient to use a Time Dependent study if you have a periodic input with many harmonics, like a square-shaped signal.

## DEFAULT FREQUENCY

In the RF module, the Frequency Domain, the Frequency-Domain Modal, and the Eigenfrequency study step have GHz as the default frequency unit and a default frequency of 1[GHz].

### *The RF Module Modeling Process*

---

The modeling process has these main steps, which (excluding the first step), correspond to the branches displayed in the Model Builder in the COMSOL Desktop environment.

- 1 Selecting the appropriate physics interface or predefined multiphysics coupling when adding a physics interface.
- 2 Defining component parameters and variables in the **Definitions** branch (☰).
- 3 Drawing or importing the component geometry in the **Geometry** branch (⚙).
- 4 Assigning material properties to the geometry in the **Materials** branch (🧩).
- 5 Setting up the model equations and boundary conditions in the physics interfaces branch.
- 6 Meshing in the **Mesh** branch (📐).
- 7 Setting up the study and computing the solution in the **Study** branch (🔄).
- 8 Analyzing and visualizing the results in the **Results** branch (🖨).



When using frequency related study steps, define the simulation frequency in the **Study** branch first. The frequency in the **Study** node will then be used for defining the physics-controlled mesh and in any frequency-based physics features.

---

Even after a model is defined, you can edit to input data, equations, boundary conditions, geometry — the equations and boundary conditions are still available through associative geometry — and mesh settings. You can restart the solver, for example, using the existing solution as the initial condition or initial guess. It is also

easy to add another physics interface to account for a phenomenon not previously described in a model.



- [Building a COMSOL Multiphysics Model](#) in the *COMSOL Multiphysics Reference Manual*
- [The RF Module Physics Interface Guide](#)
- [Selecting the Study Type](#)

---

### *Where Do I Access the Documentation and Application Libraries?*

---

A number of online resources have more information about COMSOL, including licensing and technical information. The electronic documentation, topic-based (or context-based) help, and the Application Libraries are all accessed through the COMSOL Desktop.



If you are reading the documentation as a PDF file on your computer, the [blue links](#) do not work to open an application or content referenced in a different guide. However, if you are using the Help system in COMSOL Multiphysics, these links work to open other modules, application examples, and documentation sets.

---



## **THE DOCUMENTATION AND ONLINE HELP**

The *COMSOL Multiphysics Reference Manual* describes the core physics interfaces and functionality included with the COMSOL Multiphysics license. This book also has instructions on how to use COMSOL Multiphysics and how to access the electronic Documentation and Help content.

### *Opening Topic-Based Help*

The Help window is useful as it is connected to the features in the COMSOL Desktop. To learn more about a node in the Model Builder, or a window on the Desktop, click to highlight a node or window, then press F1 to open the Help window, which then

displays information about that feature (or click a node in the Model Builder followed by the **Help** button (  ). This is called *topic-based* (or *context*) *help*.

- 
- |     |   |
|-----|---|
| Win | <p>To open the <b>Help</b> window:</p> <ul style="list-style-type: none"><li>• In the <b>Model Builder</b>, <b>Application Builder</b>, or <b>Physics Builder</b>, click a node or window and then press F1.</li><li>• On any toolbar (for example, <b>Home</b>, <b>Definitions</b>, or <b>Geometry</b>), hover the mouse over a button (for example, <b>Add Physics</b> or <b>Build All</b>) and then press F1.</li><li>• From the <b>File</b> menu, click <b>Help</b> (  ).</li><li>• In the upper-right corner of the COMSOL Desktop, click the <b>Help</b> (  ) button.</li></ul> |
|-----|---|
- 

- 
- |       |  |
|-------|--|
| Mac   | <p>To open the <b>Help</b> window:</p> <ul style="list-style-type: none"><li>• In the <b>Model Builder</b> or <b>Physics Builder</b>, click a node or window and then press F1.</li><li>• On the main toolbar, click the <b>Help</b> (  ) button.</li><li>• From the main menu, select <b>Help&gt;Help</b>.</li></ul> |
| Linux |  |
- 

### Opening the Documentation Window

- 
- |     |  |
|-----|--|
| Win | <p>To open the <b>Documentation</b> window:</p> <ul style="list-style-type: none"><li>• Press Ctrl+F1.</li><li>• From the <b>File</b> menu, select <b>Help&gt;Documentation</b> (  ).</li></ul> |
|-----|--|
- 

- 
- |       |   |
|-------|---|
| Mac   | <p>To open the <b>Documentation</b> window:</p> <ul style="list-style-type: none"><li>• Press Ctrl+F1.</li><li>• On the main toolbar, click the <b>Documentation</b> (  ) button.</li><li>• From the main menu, select <b>Help&gt;Documentation</b>.</li></ul> |
| Linux |   |
-

## THE APPLICATION LIBRARIES WINDOW

Each model or application includes documentation with the theoretical background and step-by-step instructions to create a model or application. The models and applications are available in COMSOL Multiphysics as MPH-files that you can open for further investigation. You can use the step-by-step instructions and the actual models as templates for your own modeling. In most models, SI units are used to describe the relevant properties, parameters, and dimensions, but other unit systems are available.

Once the Application Libraries window is opened, you can search by name or browse under a module folder name. Click to view a summary of the model or application and its properties, including options to open it or its associated PDF document.



[The Application Libraries Window](#) in the *COMSOL Multiphysics Reference Manual*.

---

### Opening the Application Libraries Window

To open the **Application Libraries** window ():



From the **File** menu, select **Application Libraries**.

To include the latest versions of model examples, from the **File>Help** menu, select (  ) **Update COMSOL Application Library**.

---



Select **Application Libraries** from the main **File** or **Windows** menus.



To include the latest versions of model examples, from the **Help** menu, select (  ) **Update COMSOL Application Library**.

---

## CONTACTING COMSOL BY EMAIL

For general product information, contact COMSOL at [info@comsol.com](mailto:info@comsol.com).

## COMSOL ACCESS AND TECHNICAL SUPPORT

To receive technical support from COMSOL for the COMSOL products, please contact your local COMSOL representative or send your questions to [support@comsol.com](mailto:support@comsol.com). An automatic notification and a case number will be sent to you

by email. You can also access technical support, software updates, license information, and other resources by registering for a COMSOL Access account.

#### **COMSOL ONLINE RESOURCES**

COMSOL website	<a href="http://www.comsol.com">www.comsol.com</a>
Contact COMSOL	<a href="http://www.comsol.com/contact">www.comsol.com/contact</a>
COMSOL Access	<a href="http://www.comsol.com/access">www.comsol.com/access</a>
Support Center	<a href="http://www.comsol.com/support">www.comsol.com/support</a>
Product Download	<a href="http://www.comsol.com/product-download">www.comsol.com/product-download</a>
Product Updates	<a href="http://www.comsol.com/support/updates">www.comsol.com/support/updates</a>
COMSOL Blog	<a href="http://www.comsol.com/blogs">www.comsol.com/blogs</a>
Discussion Forum	<a href="http://www.comsol.com/forum">www.comsol.com/forum</a>
Events	<a href="http://www.comsol.com/events">www.comsol.com/events</a>
COMSOL Application Gallery	<a href="http://www.comsol.com/models">www.comsol.com/models</a>
COMSOL Video Gallery	<a href="http://www.comsol.com/video">www.comsol.com/video</a>
Support Knowledge Base	<a href="http://www.comsol.com/support/knowledgebase">www.comsol.com/support/knowledgebase</a>

# Overview of the User's Guide

The *RF Module User's Guide* gets you started with modeling using COMSOL Multiphysics. The information in this guide is specific to this module. Instructions how to use COMSOL in general are included with the *COMSOL Multiphysics Reference Manual*.



As detailed in the section [Where Do I Access the Documentation and Application Libraries?](#) this information can also be searched from the COMSOL Multiphysics software **Help** menu.

## TABLE OF CONTENTS, GLOSSARY, AND INDEX

To help you navigate through this guide, see the [Contents](#), [Glossary](#), and [Index](#).

## MODELING WITH THE RF MODULE

The [RF Modeling](#) chapter familiarize you with the modeling procedures. A number of examples available through the Application Libraries window also illustrate the different aspects of the simulation process. Topics include [Preparing for RF Modeling](#), [Simplifying Geometries](#), and [Scattered Field Formulation](#).

## RF THEORY

The [Electromagnetics Theory](#) chapter contains a review of the basic theory of electromagnetics, starting with [Maxwell's Equations](#), and the theory for some [Special Calculations](#): S-parameters, lumped port parameters, and far-field analysis. There is also a list of [Electromagnetic Quantities](#) with their SI units and symbols.

## RADIO FREQUENCY

[Radio Frequency Interfaces](#) chapter describes:

- [The Electromagnetic Waves, Frequency Domain Interface](#), which analyzes frequency domain electromagnetic waves, and uses time-harmonic and eigenfrequency or eigenmode (2D only) studies, boundary mode analysis and frequency domain, modal.
- [The Electromagnetic Waves, Transient Interface](#), which supports the Time Dependent study type.
- [The Transmission Line Interface](#), which solves the time-harmonic transmission line equation for the electric potential.

- [The Electromagnetic Waves, Time Explicit Interface](#), which solves a transient wave equation for both the electric and magnetic fields.
- [The Electromagnetic Waves, Boundary Elements Interface](#), which analyzes time-harmonic electromagnetic waves using the boundary element method.

The underlying theory is also included at the end of the chapter.

### **ELECTRICAL CIRCUIT**

[AC/DC Interfaces](#) chapter describes [The Electrical Circuit Interface](#), which simulates the current in a conductive and capacitive material under the influence of an electric field. All three study types (Stationary, Frequency Domain, and Time Dependent) are available. The underlying theory is also included at the end of the chapter.

### **HEAT TRANSFER**

[Heat Transfer Interfaces](#) chapter describes the Microwave Heating interface, which combines the physics features of an Electromagnetic Waves, Frequency Domain interface from the RF Module with the Heat Transfer interface. The predefined interaction adds the electromagnetic losses from the electromagnetic waves as a heat source and solves frequency domain (time-harmonic) electromagnetic waves in conjunction with stationary or transient heat transfer. This physics interface is based on the assumption that the electromagnetic cycle time is short compared to the thermal time scale (adiabatic assumption). The underlying theory is also included at the end of the chapter.



## RF Modeling

The goal of this chapter is to familiarize you with the modeling procedure in the RF Module. A number of models available through the RF Module Applications Libraries also illustrate the different aspects of the simulation process.

In this chapter:

- [Preparing for RF Modeling](#)
- [Simplifying Geometries](#)
- [Periodic Boundary Conditions](#)
- [Scattered Field Formulation](#)
- [Modeling with Far-Field Calculations](#)
- [S-Parameters and Ports](#)
- [Lumped Ports with Voltage Input](#)
- [Jones Vectors and Polarization Plots](#)
- [Lossy Eigenvalue Calculations](#)
- [Connecting to Electrical Circuits](#)
- [SPICE Import and Export](#)

- [Reduced-Order Modeling](#)
- [Part Libraries and Material Libraries](#)

# Preparing for RF Modeling

Several modeling topics are described in this section that might not be found in ordinary textbooks on electromagnetic theory.

This section is intended to help answer questions such as:

- Which space dimension should I use: 3D, 2D axial symmetry, or 2D?
- Is my problem suited for time-dependent or frequency domain formulations?
- Can I use a quasi-static formulation or do I need wave propagation?
- What sources can I use to excite the fields?
- When do I need to resolve the thickness of thin shells and when can I use boundary conditions?
- What is the purpose of the model?
- What information do I want to extract from the model?

Increasing the complexity of a model to make it more accurate usually makes it more expensive to simulate. A complex model is also more difficult to manage and interpret than a simple one. Keep in mind that it can be more accurate and efficient to use several simple models instead of a single, complex one.



[The Physics Interfaces and Building a COMSOL Multiphysics Model](#) in the *COMSOL Multiphysics Reference Manual*

---

# Simplifying Geometries

Most of the problems that are solved with COMSOL Multiphysics are three-dimensional (3D) in the real world. In many cases, it is sufficient to solve a two-dimensional (2D) problem that is close to or equivalent to the real problem. Furthermore, it is good practice to start a modeling project by building one or several 2D models before going to a 3D model. This is because 2D models are easier to modify and solve much faster. Thus, modeling mistakes are much easier to find when working in 2D. Once the 2D model is verified, you are in a much better position to build a 3D model.

In this section:

- [2D Models](#)
- [3D Models](#)
- [Using Efficient Boundary Conditions](#)
- [Applying Electromagnetic Sources](#)
- [Meshing and Solving](#)

## *2D Models*

---

The text below is a guide to some of the common approximations made for 2D models. Remember that the modeling in 2D usually represents some 3D geometry under the assumption that nothing changes in the third dimension or that the field has a prescribed propagation component in the third dimension.

### **CARTESIAN COORDINATES**

In this case a cross section is viewed in the  $xy$ -plane of the actual 3D geometry. The geometry is mathematically extended to infinity in both directions along the  $z$ -axis, assuming no variation along that axis or that the field has a prescribed wave vector component along that axis. All the total flows in and out of boundaries are per unit length along the  $z$ -axis. A simplified way of looking at this is to assume that the geometry is extruded one unit length from the cross section along the  $z$ -axis. The total flow out of each boundary is then from the face created by the extruded boundary (a boundary in 2D is a line).

There are usually two approaches that lead to a 2D cross-section view of a problem. The first approach is when it is known that there is no variation of the solution in one particular dimension.

This is shown in the model *H-Bend Waveguide 2D*, where the electric field only has one component in the  $z$  direction and is constant along that axis. The second approach is when there is a problem where the influence of the finite extension in the third dimension can be neglected.

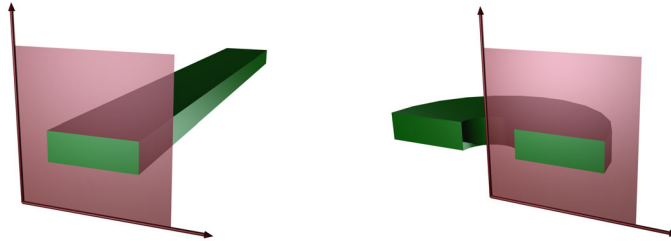

*Figure 2-1: The cross sections and their real geometry for Cartesian coordinates and cylindrical coordinates (axial symmetry).*



*H-Bend Waveguide 2D*: Application Library path **RF\_Module/Transmission\_Lines\_and\_Waveguides/h\_bend\_waveguide\_2d**

### **AXIAL SYMMETRY (CYLINDRICAL COORDINATES)**

If the 3D geometry can be constructed by revolving a cross section around an axis, and if no variations in any variable occur when going around the axis of revolution (or that the field has a prescribed wave vector component in the direction of revolution), then use an axisymmetric physics interface. The spatial coordinates are called  $r$  and  $z$ , where  $r$  is the radius. The flow at the boundaries is given per unit length along the third dimension. Because this dimension is a revolution all flows must be multiplied with  $\alpha r$ , where  $\alpha$  is the revolution angle (for example,  $2\pi$  for a full turn).



*Conical Antenna*: Application Library path **RF\_Module/Antennas/conical\_antenna**



When using the axisymmetric versions, the horizontal axis represents the radial ( $r$ ) direction and the vertical axis the  $z$  direction, and the geometry in the right half plane (that is, for positive  $r$  only) must be created.

---

### **POLARIZATION IN 2D**

In addition to selecting 2D or 2D axisymmetry when you start building the model, the physics interfaces ([The Electromagnetic Waves, Frequency Domain Interface](#) or [The Electromagnetic Waves, Transient Interface](#)) in the Model Builder offers a choice in the Components settings section. The available choices are Out-of-plane vector, In-plane vector, and Three-component vector. This choice determines what polarizations can be handled. For example, as you are solving for the electric field, a 2D TM (out-of-plane H field) model requires choosing In-plane vector as then the electric field components are in the modeling plane.

### *3D Models*

---

Although COMSOL Multiphysics fully supports arbitrary 3D geometries, it is important to simplify the problem. This is because 3D models often require more computer power, memory, and time to solve. The extra time spent on simplifying a model is probably well spent when solving it. Below are a few issues that need to be addressed before starting to implement a 3D model in this module.

- Check if it is possible to solve the problem in 2D. Given that the necessary approximations are small, the solution is more accurate in 2D, because a much denser mesh can be used.
- Look for symmetries in the geometry and model. Many problems have planes where the solution is the same on both sides of the plane. A good way to check this is to flip the geometry around the plane, for example, by turning it up-side down around the horizontal plane. Then remove the geometry below the plane if no differences are observed between the two cases regarding geometry, materials, and sources. Boundaries created by the cross section between the geometry and this plane need a symmetry boundary condition, which is available in all 3D physics interfaces.
- There are also cases when the dependence along one direction is known, and it can be replaced by an analytical function. Use this approach either to convert 3D to 2D or to convert a layer to a boundary condition.

## *Using Efficient Boundary Conditions*

---

An important technique to minimize the problem size is to use efficient boundary conditions. Truncating the geometry without introducing too large errors is one of the great challenges in modeling. Below are a few suggestions of how to do this. They apply to both 2D and 3D problems.

- Many models extend to infinity or can have regions where the solution only undergoes small changes. This problem is addressed in two related steps. First, the geometry needs to be truncated in a suitable position. Second, a suitable boundary condition needs to be applied there. For static and quasistatic models, it is often possible to assume zero fields at the open boundary, provided that this is at a sufficient distance away from the sources. For radiation problems, special low-reflecting boundary conditions need to be applied. This boundary should be in the order of a few wavelengths away from any source.

A more accurate option is to use perfectly matched layers (PMLs). PMLs are layers that absorb all radiated waves with small reflections.

Another option is to truncate the model, using [The Electromagnetic Waves, Boundary Elements Interface](#) for the infinite void domain.

- Replace thin layers with boundary conditions where possible. There are several types of boundary conditions in COMSOL Multiphysics suitable for such replacements. For example, replace materials with high conductivity by the *perfect electric conductor (PEC)* boundary condition.
- Use boundary conditions for known solutions. For example, an antenna aperture can be modeled as an equivalent surface current density on a 2D face (boundary) in a 3D model.

## *Applying Electromagnetic Sources*

---

Electromagnetic sources can be applied in many different ways. The typical options are boundary sources, line sources, and point sources, where point sources in 2D formulations are equivalent to line sources in 3D formulations. The way sources are imposed can have an impact on what quantities can be computed from the model. For example, a line source in an electromagnetic wave model represents a singularity and the magnetic field does not have a finite value at the position of the source. In a COMSOL Multiphysics model, the magnetic field of a line source has a finite but mesh-dependent value. In general, using volume or boundary sources is more flexible

than using line sources or point sources, but the meshing of the source domains becomes more expensive.

### *Meshing and Solving*

---

The finite element method approximates the solution within each element, using some elementary shape function that can be constant, linear, or of higher order. Depending on the element order in the model, a finer or coarser mesh is required to resolve the solution. In general, there are three problem-dependent factors that determine the necessary mesh resolution:

- The first is the variation in the solution due to geometrical factors. The mesh generator automatically generates a finer mesh where there is a lot of fine geometrical details. Try to remove such details if they do not influence the solution, because they produce a lot of unnecessary mesh elements.
- The second is the skin effect or the field variation due to losses. It is easy to estimate the skin depth from the conductivity, permeability, and frequency. At least two linear elements per skin depth are required to capture the variation of the fields. If the skin depth is not studied or a very accurate measure of the dissipation loss profile is not needed, replace regions with a small skin depth with a boundary condition, thereby saving elements. If it is necessary to resolve the skin depth, the boundary layer meshing technique can be a convenient way to get a dense mesh near a boundary.
- The third and last factor is the wavelength. To resolve a wave properly, it is necessary to use about 10 linear (or five 2nd order) elements per wavelength. Keep in mind that the wavelength depends on the local material properties.

### **SOLVERS**

In most cases the solver sequence generated by COMSOL Multiphysics can be used. The choice of solver is optimized for the typical case for each physics interface and study type in this module. However, in special cases tuning the solver settings can be required. This is especially important for 3D problems because they can require a large amount of memory.



In the *COMSOL Multiphysics Reference Manual*:

- [Meshing](#)
  - [Studies and Solvers](#)
-





# Periodic Boundary Conditions

The RF Module has a dedicated Periodic Condition. The periodic condition can identify simple mappings on plane source and destination boundaries of equal shape. The destination can also be rotated with respect to the source. There are three types of periodic conditions available (only the first two for transient analysis):

- *Continuity*— The tangential components of the solution variables are equal on the source and destination.
- *Antiperiodicity*— The tangential components have opposite signs.
- *Floquet periodicity*— There is a phase shift between the tangential components. The phase shift is determined by a wave vector and the distance between the source and destination. Floquet periodicity is typically used for models involving plane waves interacting with periodic structures.

Periodic boundary conditions must have compatible meshes. This can be done automatically by enabling **Physics-controlled mesh** in the **Sequence Type** section in the settings for the mesh or by manually setting up the correct mesh sequence



If more advanced periodic boundary conditions are required, for example, when there is a known rotation of the polarization from one boundary to another, see [Nonlocal Couplings and Coupling Operators](#) in the *COMSOL Multiphysics Reference Manual* for tools to define more general mappings between boundaries.



To learn how to use the Copy Mesh feature to ensure that the mesh on the destination boundary is identical to that on the source boundary, see *Plasmonic Wire Grating*: Application Library path **RF\_Module/Tutorials/plasmonic\_wire\_grating**.

For an example of how to use the **Physics-controlled mesh**, see *Fresnel Equations*: Application Library path **RF\_Module/Verification\_Examples/fresnel\_equations**.

---



In the *COMSOL Multiphysics Reference Manual*:

- [Periodic Condition](#)
  - [Periodic Boundary Conditions](#)
-

# Scattered Field Formulation

For problems where a known background field is illuminating an object in free space it is possible to use the scattered field formulation. Since the equation of the background field is known it can be entered as a model input and does not need to be computed. Starting from the frequency-domain governing equation:

$$\nabla \times (\mu^{-1} \nabla \times \mathbf{E}) - \omega^2 \epsilon_c \mathbf{E} = \mathbf{0}$$

The total electric field,  $\mathbf{E}$ , can be decomposed into two components:

$$\mathbf{E} = \mathbf{E}_{\text{total}} = \mathbf{E}_{\text{background}} + \mathbf{E}_{\text{relative}}$$

The known background field becomes a source term and the scattered field formulation thus solves for the relative electric field. A linearly polarized plane wave background field, a paraxial-approximate Gaussian beam, or a user-defined background field can be specified. When solving the scattered field formulation the total, the background, and the relative electric fields are available. The relative field is the difference between the background field and the total field. It is the relative field that contributes to the far-field calculation. For more information about the Far-Field computation, see [Far-Field Calculations Theory](#). The benefit to this approach is that if the background field is much larger in magnitude than the scattered field, the accuracy of the simulation improves if the relative field is solved for. Another advantage is that it becomes very easy to set up a perfectly matched layer surrounding the homogeneous medium modeling domain.

The drawback to this approach is that the relative field requires some careful interpretation. The relative electric field can conceptually be decomposed into:

$$\mathbf{E}_{\text{relative}} = \mathbf{E}_{\text{scattered}} + \mathbf{E}_{\text{correction}} + \mathbf{E}_{\text{cancellation}}$$

The  $\mathbf{E}_{\text{scattered}}$  component is the scattered field from object. This is the field that is of interest in a scattering problem. However, the relative field may also consist of a component that represents a correction to the background field and a cancellation of the background field. The  $\mathbf{E}_{\text{correction}}$  component can be nonzero when the background field does not exactly satisfy Maxwell's equations, such as when the paraxial Gaussian beam approximation is used for a tightly focused beam. For more information about the Gaussian beam theory, see [Gaussian Beams as Background Fields and Input Fields](#). The  $\mathbf{E}_{\text{cancellation}}$  component will be nonzero and equal to  $-\mathbf{E}_{\text{background}}$  wherever the total field should be zero, such as in the interior of any

perfectly shielded objects, or behind a relatively large shielding object. Note that this decomposition is conceptual only, it is only the relative field that is available.

An alternative of using the scattered-field formulation, is to use ports with the **Activate slit condition on interior port** setting enabled. Then the domain can be excited by the interior port and the outgoing field can be absorbed by perfectly matched layers. For more information about the **Port** feature and the **Activate slit condition on interior port** setting, see [Port Properties](#).

#### **SCATTERED FIELDS SETTING**

The scattered-field formulation is available for [The Electromagnetic Waves, Frequency Domain Interface](#) under the **Settings** section. The scattered field in the analysis is called the relative electric field. The total electric field is always available, and for the scattered-field formulation this is the sum of the scattered field and the incident field.



*Radar Cross Section:* Application Library path **RF\_Module/**  
**Scattering\_and\_RCS/radar\_cross\_section**

---

# Modeling with Far-Field Calculations

The far electromagnetic field from, for example, antennas can be calculated from the near-field solution on a boundary using far-field analysis. The antenna is located in the vicinity of the origin, while the far field is taken at infinity but with a well-defined angular direction  $(\theta, \varphi)$ . The far-field radiation pattern is given by evaluating the squared norm of the far field on a sphere centered at the origin. Each coordinate on the surface of the sphere represents an angular direction.

In this section:

- [Far-Field Support in the Electromagnetic Waves, Frequency Domain Interface](#)
- [The Radiation Pattern Plots](#)



*Radar Cross Section*: Application Library path **RF\_Module/**  
**Scattering\_and\_RCS/radar\_cross\_section**

---

## *Far-Field Support in the Electromagnetic Waves, Frequency Domain Interface*

---

The Electromagnetic Waves, Frequency Domain interface supports far-field analysis. To define the far-field variables use the [Far-Field Calculation](#) node. Select a domain for the far-field calculation. Then select the boundaries where the algorithm integrates the near field, and enter a name for the far electric field. Also specify if symmetry planes are used in the model when calculating the far-field variable. The symmetry planes have to coincide with one of the Cartesian coordinate planes. For each of these planes it is possible to select the type of symmetry to use, which can be of either *symmetry in E (PMC)* or *symmetry in H (PEC)*. Make the choice here match the boundary condition used for the symmetry boundary. Using these settings, the parts of the geometry that are not in the model for symmetry reasons can be included in the far-field analysis.

The [Far-Field Domain](#) and the [Far-Field Calculation](#) nodes get their selections automatically, if the Perfectly Matched Layer (PML) feature has been defined before adding the [Far-Field Domain](#) feature.

For each variable name entered, the software generates functions and variables, which represent the vector components of the far electric field. The names of these variables

are constructed by appending the names of the independent variables to the name entered in the field.

For example, the name `Efar` is entered and the geometry is Cartesian with the independent variables `x`, `y`, and `z`, the generated variables get the names `Efarx`, `Efary`, and `Efarz`.

If, on the other hand, the geometry is axisymmetric with the independent variables `r`, `phi`, and `z`, the generated variables get the names `Efarr`, `Efarphi`, and `Efarz`.

In 2D, the software only generates the variables for the nonzero field components. The physics interface name also appears in front of the variable names so they can vary, but typically look something like `emw.Efarz` and so forth.

To each of the generated variables, there is a corresponding function with the same name. This function takes the vector components of the evaluated far-field direction as arguments.

The vector components also can be interpreted as a position. For example, assume that the variables `dx`, `dy`, and `dz` represent the direction in which the far electric field is evaluated.

The expression

```
Efarx(dx, dy, dz)
```

gives the value of the far electric field in this direction. To give the direction as an angle, use the expression

```
Efarx(sin(theta)*cos(phi), sin(theta)*sin(phi), cos(theta))
```

where the variables `theta` and `phi` are defined to represent the angular direction ( $\theta$ ,  $\phi$ ) in radians. The magnitude of the far field and its value in dB are also generated as the variables `normEfar` and `normdBEfar`, respectively.



---

### *The Radiation Pattern Plots*

The **Radiation Pattern** plots are available with this module to plot the value of a global variable (for example, the far field norm, `normEfar` and `normdBEfar`, or components of the far-field variable `Efar`).

The variables are plotted for a selected number of angles on a unit circle (in 2D) or a unit sphere (in 3D). The angle interval and the number of angles can be manually specified. For 2D **Radiation Pattern** plots, the reference direction from which the angle is measured and the normal to the plane the far field is computed for can also be specified. For 3D **Radiation Pattern** plots, you also specify an expression for the surface color.

The main advantage with the **Radiation Pattern** plot, as compared to making a **Line Graph**, is that the unit circle or sphere that you use for defining the plot directions is not part of your geometry for the solution. Thus, the number of plotting directions is decoupled from the discretization of the solution domain.



Default **Radiation Pattern** plots of far-field norm are automatically added to any model that uses far field calculation features.

TABLE 2-1: VARIABLES AND OPERATORS GENERATED BY FAR FIELD

	DESCRIPTION	NAME	AVAILABLE COMPONENT
Variables	Far-field norm	normEfar	2D, 2D Axisymmetric, 3D
	Far-field norm, dB	normdBefar	2D, 2D Axisymmetric, 3D
	Far-field variable, x component	Efarx	2D, 2D Axisymmetric, 3D
	Far-field variable, y component	Efary	2D, 2D Axisymmetric, 3D
	Far-field variable, z component	Efarz	2D, 2D Axisymmetric, 3D
	Effective isotropic radiated power	EIRP	3D
	Effective isotropic radiated power, dB	EIRPdB	3D
	Far-field gain	gainEfar	3D
	Far-field gain, dB	gaindBefar	3D
	Axial ratio	axialRatio	3D
	Axial ratio, dB	axialRatiodB	3D
	Bistatic radar cross section	bRCS3D	3D
	Far-field variable, phi component	Efarphi	3D



TABLE 2-1: VARIABLES AND OPERATORS GENERATED BY FAR FIELD

	DESCRIPTION	NAME	AVAILABLE COMPONENT
	Far-field variable, theta component	Efartheta	3D
	Far-field realized gain	rGainEfar	3D
	Far-field realized gain, dB	rGaindBefar	3D
	Total radiated power	TRP	3D
	Total radiated power, dB	TRPdB	3D
	Bistatic radar cross section per unit length	bRCS2D	2D
	Maximum directivity <sup>1</sup>	maxD	2D Axisymmetric, 3D
	Maximum directivity, dB <sup>1</sup>	maxDdB	2D Axisymmetric, 3D
	Maximum gain <sup>1</sup>	maxGain	2D Axisymmetric, 3D
	Maximum gain, dB <sup>1</sup>	maxGaindB	2D Axisymmetric, 3D
	Maximum realized gain <sup>1</sup>	maxRGain	2D Axisymmetric, 3D
	Maximum realized gain, dB <sup>1</sup>	maxRGaindB	2D Axisymmetric, 3D
Functions <sup>4</sup>	3D far-field norm <sup>2</sup>	norm3DEfar	2D Axisymmetric
	3D far-field norm, dB <sup>2</sup>	normdB3DEfar	2D Axisymmetric
	Uniform three dimensional array factor <sup>3</sup>	af3	2D Axisymmetric, 3D
	Uniform two dimensional array factor <sup>3</sup>	af2	2D

<sup>1</sup>See [Directivity via Global Evaluation](#).

<sup>2</sup>See [3D Far-Field Norm Functions in 2D Axisymmetry](#).

<sup>3</sup>See [Array factor operators](#).

<sup>4</sup>See [Far-Field Analysis Using Functions and Operators](#).

## FAR-FIELD ANALYSIS USING FUNCTIONS AND OPERATORS

The postprocessing far-field functions are available under

**Component>Definitions>Functions**. Below you find example models using these functions and some links to more information.

---

	<ul style="list-style-type: none"><li>• 2D example with a Polar Plot Group — <i>Radar Cross Section</i>: Application Library path <b>RF_Module/Scattering_and_RCS/radar_cross_section</b></li><li>• 2D axisymmetric example with a Polar Plot Group and a 3D Plot Group — <i>Conical Antenna</i>: Application Library path <b>RF_Module/Antennas/conical_antenna</b></li><li>• 3D example with a Polar Plot Group and a 3D Plot Group — <i>Radome with Double-Layered Dielectric Lens</i>: Application Library path <b>RF_Module/Antennas/radome_antenna</b></li><li>• Uniform array factor operator used in a Polar Plot Group and a 3D Plot Group — <i>Microstrip Patch Antenna</i>: Application Library path <b>RF_Module/Antenna_Arrays/microstrip_patch_antenna_inset</b></li></ul>
	<ul style="list-style-type: none"><li>• <a href="#">Far-Field Support in the Electromagnetic Waves, Frequency Domain Interface</a></li><li>• <a href="#">Radiation Pattern</a> in the <i>COMSOL Multiphysics Reference Manual</i></li></ul>

---

### 3D Far-Field Norm Functions in 2D Axisymmetry

The functions `norm3DEfar` and `normdB3DEfar` calculate the 3D far-field norms, based on field solutions in 2D axisymmetric geometry. These functions are available in these cases:

- Far-field analysis using circular port excitation with a positive azimuthal mode number
- Scattered field analysis excited by the predefined circularly polarized plane wave type

The function can be used in a 3D **Radiation Pattern** plot, where the input argument of the function must be same as the **Azimuth angle variable** in the **Evaluation** section in the **Settings** window.

The suffix of a function name varies based on the circular port mode type, port mode number, and azimuthal mode number in the physics interface. For example, when using azimuthal mode number 1 in the physics interface and transverse electric (TE)

mode with mode number 2 in the port settings, the generated operator name is `norm3DEfar_TE12`.

When the function is used in a radiation pattern plot under a 1D or a polar plot group, the value of input argument defines the plotting plane regardless of the normal and reference direction in the **Evaluation** section in the **Settings** window. For example, `norm3DEfar_TE12(0)` evaluates the norm of the electric far field for the TE12 mode for a 0-degree azimuthal angle. This is equivalent to plotting this variable on the *xz*-plane. Similarly, `norm3DEfar_TE12(pi/2)` is the evaluation at a 90-degree azimuthal angle, which is equivalent to plotting the variable on the *yz*-plane.

The 3D far-field norm, the linear superposition of the positive and negative azimuthal modes scaled by 0.5, is

$$\sqrt{|E_r \cos m\phi|^2 + |E_\phi \sin m\phi|^2 + |E_z \cos m\phi|^2},$$

where  $\phi$  is the azimuthal angle.

#### *Array factor operators*

The equation for the uniform three dimensional array factor operator **af3** is

$$\frac{\sin\left(\frac{n_x}{2}(2\pi d_x \sin\theta \cos\phi + \alpha_x)\right)}{\sin\left(\frac{2\pi d_x \sin\theta \cos\phi + \alpha_x}{2}\right)}, \frac{\sin\left(\frac{n_y}{2}(2\pi d_y \sin\theta \cos\phi + \alpha_y)\right)}{\sin\left(\frac{2\pi d_y \sin\theta \cos\phi + \alpha_y}{2}\right)}$$

$$\cdot \frac{\sin\left(\frac{n_z}{2}(2\pi d_z \sin\theta \cos\phi + \alpha_z)\right)}{\sin\left(\frac{2\pi d_z \sin\theta \cos\phi + \alpha_z}{2}\right)},$$

where  $\theta$  is the elevation angle and  $\phi$  is the azimuthal angle.

The uniform two-dimensional array factor operator **af2** is simpler than the three-dimensional version, as the third, the *z*-component factor, is unity.

The number of input arguments for the array factor operators depends on the dimension of model component, 2D, 2D Axisymmetric, or 3D.

TABLE 2-2: INPUT ARGUMENTS OF ARRAY FACTOR OPERATOR

ARGUMENT	DESCRIPTION	UNIT	COMPONENT
nx	Number of elements along x-axis	Dimensionless	2D, 2D Axisymmetric, 3D
ny	Number of elements along y-axis	Dimensionless	2D, 2D Axisymmetric, 3D
nz	Number of elements along z-axis	Dimensionless	2D Axisymmetric, 3D
dx	Distance between array elements along x-axis	Wavelength	2D, 2D Axisymmetric, 3D
dy	Distance between array elements along y-axis	Wavelength	2D, 2D Axisymmetric, 3D
dz	Distance between array elements along z-axis	Wavelength	2D Axisymmetric, 3D
alphax	Phase progression along x-axis	Radian	2D, 2D Axisymmetric, 3D
alphay	Phase progression along y-axis	Radian	2D, 2D Axisymmetric, 3D
alphaz	Phase progression along z-axis	Radian	2D Axisymmetric, 3D

## ANTENNA ANALYSIS USING FAR-FIELD VARIABLES

The directional properties of a radiation pattern described by variables, generated from a far-field calculation feature, help to characterize the performance of antenna devices.

### *Directivity from a 3D Plot*

While plotting a 3D radiation pattern, the maximum directivity can be calculated by evaluating the ratio between the radiation intensity and the average value of the radiation intensity. Since the radiation intensity is a function of power, the square of the far-field norm has to be used in the **Directivity expression** in the **Radiation Pattern** settings window for the antenna directivity calculation. For other physics interfaces, such as in the Acoustics module, the expression is different.

### *Directivity via Global Evaluation*

The maximum directivity can be computed through **Results>Derived Values>Global Evaluation**. This calculation is based on the maximum and averaged intensity values on the far-field calculation selection. It requires the selection for the far-field calculation feature to be spherical for 3D and circular for 2D axisymmetric model components, both centered at the origin.

### *Gain*

The antenna realized gain is defined as

$$G_{\text{realized}} = \frac{4\pi U}{P_{\text{in}}} = \frac{|\text{normEfar}|^2}{60P_{\text{in}}}$$

where  $U$  is the radiation intensity,  $\text{Re}(\bar{E}_{\text{far}} \times \bar{H}_{\text{far}}^*)/2 = |\text{normEfar}|^2/240\pi$ , and  $P_{\text{in}}$  is the total input power.

The antenna gain is

$$G = \frac{|\text{normEfar}|^2}{60P_{\text{delivered}}}$$

where the delivered power,  $P_{\text{delivered}}$  is  $P_{\text{in}}(1 - |S_{11}|^2)$ . The gain is available only when the S-parameter calculation is valid, that is, for the single port excitation case.

# S-Parameters and Ports

In this section:

- [S-Parameters in Terms of Voltage and Electric Field](#)
- [S-Parameter Calculations](#)
- [S-Parameter Variables](#)
- [Port Sweeps/Manual Terminal Sweeps and Touchstone Export](#)

## *S-Parameters in Terms of Voltage and Electric Field*

---

Scattering parameters (or S-parameters) are complex-valued, frequency dependent matrices describing the transmission and reflection of electromagnetic waves at different ports of devices like filters, antennas, waveguide transitions, and transmission lines. S-parameters originate from transmission-line theory and are defined in terms of transmitted and reflected voltage waves. All ports are assumed to be connected to matched loads/feeds, that is, there is no reflection directly at a port.

For a device with  $n$  ports, the S-parameters are

$$S = \begin{bmatrix} S_{11} & S_{12} & \cdots & S_{1n} \\ S_{21} & S_{22} & \cdots & \cdot \\ \cdot & \cdot & \cdots & \cdot \\ \cdot & \cdot & \cdots & \cdot \\ S_{n1} & \cdot & \cdots & S_{nn} \end{bmatrix}$$

where  $S_{11}$  is the voltage reflection coefficient at port 1,  $S_{21}$  is the voltage transmission coefficient from port 1 to port 2, and so on. The time average power reflection/transmission coefficients are obtained as  $|S_{ij}|^2$ .

Now, for high-frequency problems, voltage is not a well-defined entity, and it is necessary to define the scattering parameters in terms of the electric field.



For details on how COMSOL Multiphysics calculates the S-parameters, see [S-Parameter Calculations](#).

---

## *S-Parameter Calculations*

---

The RF interfaces have built-in support for S-parameter calculations. Use a *Port* boundary feature for each port in the model. For connecting transmission lines and other lumped feeds, use a *lumped port* that approximates a connecting transmission lines or a voltage source with a known internal impedance. The lumped port should only be used when the port width is much smaller than the wavelength.



- For more details about lumped ports, see [Lumped Ports with Voltage Input](#).
- See [Port](#) and [Lumped Port](#) for instructions to set up a model.



For a detailed description of how to model numerical ports with a boundary mode analysis, see *Waveguide Adapter*: Application Library path **RF\_Module/Transmission\_Lines\_and\_Waveguides/waveguide\_adapter**.

## *S-Parameter Variables*

---

This module automatically generates variables for the S-parameters. The port names (use numbers for sweeps to work correctly) determine the variable names. If, for example, there are two ports with the numbers 1 and 2 and Port 1 is the inport, the software generates the variables **S11** and **S21**. **S11** is the S-parameter for the reflected wave and **S21** is the S-parameter for the transmitted wave. For convenience, two variables for the S-parameters on a dB scale, **S11dB** and **S21dB**, are also defined using the following relation:

$$S_{11\text{dB}} = 20\log_{10}(|S_{11}|)$$

The model and physics interface names also appear in front of the variable names so they can vary. The S-parameter variables are added to the predefined quantities in appropriate plot lists.

## *Port Sweeps/Manual Terminal Sweeps and Touchstone Export*

---

The [Port Sweep Settings](#) section in the Electromagnetic Waves interface describes how to cycle through the ports, compute the entire S-matrix and export it to a Touchstone file.

The Frequency Domain Source Sweep study is another way of making efficient port sweeps. It is available as a preset study for the Electromagnetic Waves, Frequency Domain interface.

Exporting a Touchstone file can also be performed by right-clicking the **Export** node under **Results** and selecting **Touchstone** or by selecting **Touchstone** under **Data** in the **Results** ribbon toolbar (Windows users) or the **Results** context menu (Mac and Linux users).



*H-Bend Waveguide 3D*: Application Library path **RF\_Module/**  
**Transmission\_Lines\_and\_Waveguides/h\_bend\_waveguide\_3d**

---



# Lumped Ports with Voltage Input

In this section:

- [About Lumped Ports](#)
- [Lumped Port Parameters](#)
- [Lumped Ports in the RF Module](#)

## *About Lumped Ports*

---

The ports described in the [S-Parameters and Ports](#) section require a detailed specification of the mode, including the propagation constant and field profile. In situations with the mode being TEM, a lumped port might be a better choice. It also allows for connecting to an electrical circuit. It is not as accurate as the ordinary port in terms of calculating S-parameters, but it is easier to use. Lumped ports are used to model a connecting transmission line or as a voltage or current source applied between electrodes. For example, apply a lumped port directly to a printed circuit board or to the transmission line feed of a device. The lumped port must be applied between two metallic objects separated by a distance much smaller than the wavelength, that is a local *quasi-static approximation* must be justified. This is because the concept of port or gap voltage breaks down unless the gap is much smaller than the local wavelength.

A lumped port specified as an input port calculates the impedance,  $Z_{\text{port}}$ , and  $S_{11}$  S-parameter for that port. The parameters are directly given by the relations

$$Z_{\text{port}} = \frac{V_{\text{port}}}{I_{\text{port}}}$$
$$S_{11} = \frac{V_{\text{port}} - V_{\text{in}}}{V_{\text{in}}}$$

where  $V_{\text{port}}$  is the extracted voltage for the port given by the electric field line integral between the terminals averaged over the entire port. The current  $I_{\text{port}}$  is the averaged total current over all cross sections parallel to the terminals. Ports not specified as input ports only return the extracted voltage and current.



[Lumped Port Parameters](#)

---

## Lumped Port Parameters

In transmission line theory voltages and currents are dealt with rather than electric and magnetic fields, so the lumped port provides an interface between them. The requirement on a lumped port is that the feed point must be similar to a transmission line feed, so its gap must be much less than the wavelength. It is then possible to define the electric field from the voltage as

$$V = \int_h \mathbf{E} \cdot d\mathbf{l} = \int_h (\mathbf{E} \cdot \mathbf{a}_h) dl$$

where  $h$  is a line between the terminals at the beginning of the transmission line, and the integration is going from positive (phase)  $V$  to ground. The current is positive going into the terminal at positive  $V$ .

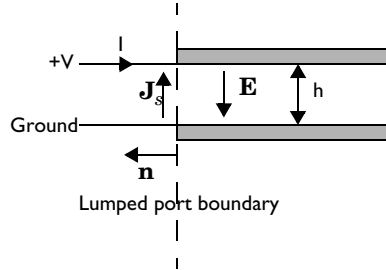

The transmission line current can be represented with a surface current at the lumped port boundary directed opposite to the electric field.

The impedance of a transmission line is defined as

$$Z = \frac{V}{I}$$

and in analogy to this an equivalent surface impedance is defined at the lumped port boundary

$$\eta = \frac{\mathbf{E} \cdot \mathbf{a}_h}{\mathbf{J}_s \cdot (-\mathbf{a}_h)}$$

To calculate the surface current density from the current, integrate along the width,  $w$ , of the transmission line

$$I = \int_w (\mathbf{n} \times \mathbf{J}_s) \cdot d\mathbf{l} = -\int_w (\mathbf{J}_s \cdot \mathbf{a}_h) dl$$

where the integration is taken in the direction of  $\mathbf{a}_h \times \mathbf{n}$ . This gives the following relation between the transmission line impedance and the surface impedance

$$Z = \frac{V}{I} = \frac{\int (\mathbf{E} \cdot \mathbf{a}_h) dl}{-\int_w (\mathbf{J}_s \cdot \mathbf{a}_h) dl} = \eta \frac{\int (\mathbf{E} \cdot \mathbf{a}_h) dl}{\int_w (\mathbf{E} \cdot \mathbf{a}_h) dl} \approx \eta \frac{h}{w} \Rightarrow$$

$$\eta = Z \frac{w}{h}$$

where the last approximation assumed that the electric field is constant over the integrations. A similar relationship can be derived for coaxial cables

$$\eta = Z \frac{2\pi}{\ln \frac{b}{a}}$$

The transfer equations above are used in an impedance type boundary condition, relating surface current density to tangential electric field via the surface impedance.

$$\mathbf{n} \times (\mathbf{H}_1 - \mathbf{H}_2) + \frac{1}{\eta} \mathbf{n} \times (\mathbf{E} \times \mathbf{n}) = 2 \frac{1}{\eta} \mathbf{n} \times (\mathbf{E}_0 \times \mathbf{n})$$

where  $\mathbf{E}$  is the total field and  $\mathbf{E}_0$  the incident field, corresponding to the total voltage,  $V$ , and incident voltage,  $V_0$ , at the port.



When using the lumped port as a circuit port, the port voltage is fed as input to the circuit and the current computed by the circuit is applied as a uniform current density, that is as a surface current condition. Thus, an open (unconnected) circuit port is just a continuity condition.

---

### *Lumped Ports in the RF Module*

---

Not all models can use lumped ports due to the polarization of the fields and how sources are specified. For the physics interfaces and study types that support the lumped port, the Lumped Port is available as a boundary feature. See [Lumped Port](#) for instructions to set up this feature.

### LUMPED PORT VARIABLES

Each lumped port generates variables that are accessible to the user. Apart from the S-parameter, a lumped port condition also generates the following variables.

NAME	DESCRIPTION
Vport	Extracted port voltage
Iport	Port current
Zport	Port impedance

For example, a lumped port with port number 1, defined in the first geometry, for the Electromagnetic Waves interface with the tag `emw`, defines the port impedance variable `emw.Zport_1`.



*RF Coil*: Application Library path **RF\_Module/Passive\_Devices/rf\_coil**

# Jones Vectors and Polarization Plots

In this section:

- [Jones Vectors for Polarization Analysis](#)
- [Polarization Plots](#)
- [Jones Vector Variables](#)

## *Jones Vectors for Polarization Analysis*

---

Periodic ports and Diffraction order ports launch and absorb plane waves propagating in homogeneous domains (adjacent the port boundary). For a plane wave propagating with the wave vector  $\mathbf{k}$ , the polarization must be orthogonal to the wave vector. For each wave vector, there are two possible orthogonal polarizations. We can select one such set of orthogonal polarizations by first defining the out-of-plane polarization as the field in the direction  $\mathbf{e}_1 = \mathbf{k} \times \mathbf{n}$ , where  $\mathbf{n}$  is the normal direction to the port. Then the in-plane polarization direction is defined as  $\mathbf{e}_2 = \mathbf{e}_1 \times \mathbf{k}$ .

Assuming now that  $\mathbf{e}_1$  and  $\mathbf{e}_2$  are normalized base vectors, the electric field can be expanded as

$$\mathbf{E} = E_1 \mathbf{e}_1 + E_2 \mathbf{e}_2,$$

where  $E_1$  and  $E_2$  are the elements of the Jones vector

$$\begin{pmatrix} E_1 \\ E_2 \end{pmatrix}.$$



In COMSOL, the Jones vector elements are complex numbers and the Jones vectors are not normalized.

---

If the Jones vector elements have the same phase or a  $\pi$  phase difference, the Jones vector represents a linear polarization state. A phase difference of  $\pm\pi/2$  between the

two Jones vector elements defines a circular polarization state. For other phase differences, the Jones vector represents elliptic polarization states.



For more details about the different types of periodic ports, see

- [Periodic](#)
- [Diffraction Order](#)
- [Orthogonal Polarization](#)

---

### *Polarization Plots*

---

Default Polarization plots are automatically generated for [Periodic](#) ports in 3D and in 2D, if the **Electric field components for** setting in the **Components** section for the physics interface is set to **Three-component vector**. The Polarization plot includes polarization ellipses for each diffraction order. The polarization ellipses are generated by plotting the in-plane Jones vector element versus the out-of-plane Jones vector element for a phase change of  $2\pi$ .



In the *COMSOL Multiphysics Reference Manual* you can find more information about the [Polarization](#) plot type.



For an example model including a Polarization plot, see *Hexagonal Grating*: Application Library path **RF\_Module/Tutorials/hexagonal\_grating**.

---

### *Jones Vector Variables*

---

This module automatically generates variables for the Jones vector elements. As for [Polarization Plots](#), the variables are created for [Periodic](#) ports in 3D and in 2D, if the **Electric field components for** setting in the **Components** section for the physics interface is set to **Three-component vector**. The variables are available for postprocessing as global variables, with names based on what port boundary the variable is applicable for, the polarization direction, and the mode number. The context above is encoded in a variable name of the form `tag.JXYYY_Z`, where

- `tag` is the physics interface tag, for example `emw`.
- `X` is `R` if the port is located on the same side as the exciting port or otherwise `T`.

- YYY is OOP or IP for the out-of-plane and in-plane modes, respectively.
- Z is the mode number that in 2D is provided as a single signed integer and in 3D as two signed integers separated by an underscore. The signed integers use the prefix p for positive values and n for negative values.

Thus, the variable `emw.JROOP_0_n1` represents the Jones vector element for the out-of-plane mode in 3D with mode numbers  $m = 0$  and  $n = -1$  for a port located on the same boundary as the exciting Periodic port.

There are also variables for the norm of the Jones vector, named as `tag.normJX_Z`, where X and Z represents the boundary location and mode number, respectively. Thus, the variable `emw.normJR_0_n1` represents the Jones vector norm in 3D with mode numbers  $m = 0$  and  $n = -1$  for a port located on the same boundary as the exciting Periodic port.

The base vectors are available for evaluation on the port boundaries, with variable names like `tag.eJYYYY[xyz]_Z`, where tag, X, YYY, and Z have the same meanings as for the variables discussed above and [xyz] is one of the Cartesian components. Thus, `emw.eJTIPx_p1`, is the x-component of the in-plane base vector for a 2D port, with mode number  $m = +1$ , that is not located on the same boundary as the exciting port.

# Lossy Eigenvalue Calculations

In mode analysis and eigenfrequency analysis, it is usually the primary goal to find a propagation constant or an eigenfrequency. These quantities are often real-valued although it is not necessary. If the analysis involves some lossy part, like a nonzero conductivity or an open boundary, the eigenvalue is complex. In such situations, the eigenvalue is interpreted as two parts (1) the propagation constant or eigenfrequency and (2) the damping in space and time.

In this section:

- [Eigenfrequency Analysis](#)
- [Mode Analysis and Boundary Mode Analysis](#)



*Lossy Circular Waveguide*: Application Library path **RF\_Module/Transmission\_Lines\_and\_Waveguides/lossy\_circular\_waveguide**

---

## *Eigenfrequency Analysis*

---

The eigenfrequency analysis solves for the eigenfrequency of a model. The time-harmonic representation of the fields is more general and includes a complex parameter in the phase

$$\mathbf{E}(\mathbf{r}, t) = \text{Re}(\tilde{\mathbf{E}}(\mathbf{r}_T)e^{j\omega t}) = \text{Re}(\tilde{\mathbf{E}}(\mathbf{r})e^{-\lambda t})$$

where the eigenvalue,  $(-\lambda) = -\delta + j\omega$ , has an imaginary part representing the eigenfrequency, and a real part responsible for the damping. It is often more common to use the *quality factor* or *Q factor*, which is derived from the eigenfrequency and damping

$$Q_{\text{fact}} = \frac{\omega}{2|\delta|}$$



## VARIABLES AFFECTED BY EIGENFREQUENCY ANALYSIS

The following list shows the variables that the eigenfrequency analysis affects:

NAME	EXPRESSION	CAN BE COMPLEX	DESCRIPTION
omega	imag(-lambda)	No	Angular frequency
damp	real(lambda)	No	Damping in time
Qfact	0.5*omega/abs(damp)	No	Quality factor
nu	omega/(2*pi)	No	Frequency

## NONLINEAR EIGENFREQUENCY PROBLEMS

For some combinations of formulation, material parameters, and boundary conditions, the eigenfrequency problem can be nonlinear, which means that the eigenvalue enters the equations in another form than the expected second-order polynomial form. The following table lists those combinations:

SOLVE FOR	CRITERION	BOUNDARY CONDITION
E	Nonzero conductivity	Impedance boundary condition
E	Nonzero conductivity at adjacent domain	Scattering boundary condition
E	Analytical ports	Port boundary condition

These situations may require special treatment, especially since it can lead to “singular matrix” or “undefined value” messages if not treated correctly. Under normal circumstances, the automatically generated solver settings should handle the cases described in the table above. However, the following discussion provide some background to the problem of defining the eigenvalue linearization point. The complication is not only the nonlinearity itself, it is also the way it enters the equations. For example the impedance boundary conditions with nonzero boundary conductivity has the term

$$-(-\lambda) \frac{\sqrt{\epsilon_0 \mu_0} \sqrt{\mu_{rbnd}} (\mathbf{n} \times (\mathbf{n} \times \mathbf{H}))}{\sqrt{\epsilon_{rbnd} + \frac{\sigma_{bnd}}{(-\lambda)\epsilon_0}}}$$

where  $(-\lambda) = -\delta + j\omega$ . When the solver starts to solve the eigenfrequency problem it linearizes the entire formulation with respect to the eigenvalue around a certain linearization point. By default this linearization point is set to the value provided to the **Search for eigenvalues around** field, for the three cases listed in the table above. Normally, this should be a good value for the linearization point. For instance, for the

impedance boundary condition, this avoids setting the eigenvalue  $\lambda$  to zero in the denominator in the equation above. For other cases than those listed in the table above, the default linearization point is zero.

If the default values for the linearization point is not suitable for your particular problem, you can manually provide a “good” linearization point for the eigenvalue solver. Do this in the **Eigenvalue** node (not the Eigenfrequency node) under the **Solver Sequence** node in the **Study** branch of the Model Builder. A solver sequence can be generated first. In the **Linearization Point** section, select the **Transform point** check box and enter a suitable value in the **Point** field. For example, if it is known that the eigenfrequency is close to 1 GHz, enter the eigenvalue 1 [GHz] in the field.

In many cases it is enough to specify a good linearization point and then solve the problem once. If a more accurate eigenvalue is needed, an iterative scheme is necessary:

- 1 Specify that the eigenvalue solver only searches for one eigenvalue. Do this either for an existing solver sequence in the **Eigenvalue** node or, before generating a solver sequence, in the **Eigenfrequency** node.
- 2 Solve the problem with a “good” linearization point. As the eigenvalue shifts, use the same value with the real part removed from the eigenvalue or, equivalently, use the real part of the eigenfrequency.
- 3 Extract the eigenvalue from the solution and update the linearization point and the shift.
- 4 Repeat until the eigenvalue does not change more than a desired tolerance.



- For a list of the studies available by physics interface, see [The RF Module Physics Interface Guide](#)
  - [Studies and Solvers](#) in the *COMSOL Multiphysics Reference Manual*
- 

### *Mode Analysis and Boundary Mode Analysis*

---

In mode analysis and boundary mode analysis COMSOL Multiphysics solves for the propagation constant. The time-harmonic representation is almost the same as for the eigenfrequency analysis, but with a known propagation in the out-of-plane direction

$$\mathbf{E}(\mathbf{r}, t) = \text{Re}(\tilde{\mathbf{E}}(\mathbf{r})e^{j\omega t - \alpha z})$$

The spatial parameter,  $\alpha = -\lambda$ , can have a real part and an imaginary part. For mode analysis the propagation constant,  $\beta$ , is equal to the imaginary part and the real part,  $\delta_z$ , represents the damping along the propagation direction. Thus,

$$\alpha = \delta_z + j\beta = -\lambda,$$

where  $\lambda$  is the eigenvalue.

For boundary mode analysis, the propagation constant,  $\beta$ , is complex,

$$\alpha = j\beta = -\lambda.$$

### VARIABLES INFLUENCED BY MODE ANALYSIS

The following table lists the variables that are influenced by the mode analysis:

NAME	EXPRESSION	CAN BE COMPLEX	DESCRIPTION
beta	imag(-lambda)	No	Propagation constant
dampz	real(-lambda)	No	Attenuation constant
dampzdB	20*log10(exp(1))*dampz	No	Attenuation per meter in dB
neff	j*lambda/k0	Yes	Effective mode index

In the table above, lambda is the eigenvalue and k0 is the vacuum wave number.

### VARIABLES INFLUENCED BY BOUNDARY MODE ANALYSIS

The table below lists the variables that are influenced by the boundary-mode analysis:

NAME	EXPRESSION	CAN BE COMPLEX	DESCRIPTION
beta_i	j*lambda	Yes	Propagation constant
neff_i	beta_i/k0	Yes	Effective mode index

The name suffix indicates that the variables are defined for the port named i.



For an example of Boundary Mode Analysis, see the model *Polarized Circular Ports*: Application Library path **RF\_Module/Tutorials/polarized\_circular\_ports**.



- For a list of the studies available by physics interface, see [The RF Module Physics Interface Guide](#)
  - [Studies and Solvers](#) in the *COMSOL Multiphysics Reference Manual*
-

# Connecting to Electrical Circuits

In this section:

- [About Connecting Electrical Circuits to Physics Interfaces](#)
- [Connecting Electrical Circuits Using Predefined Couplings](#)
- [Connecting Electrical Circuits by User-Defined Couplings](#)
- [Solving](#)
- [Postprocessing](#)



*Connecting a 3D Electromagnetic Wave Model to an Electrical Circuit:* Application Library path **RF\_Module/Transmission\_Lines\_and\_Waveguides/coaxial\_cable\_circuit**

---

## *About Connecting Electrical Circuits to Physics Interfaces*

---

This section describes the various ways electrical circuits can be connected to other physics interfaces in COMSOL Multiphysics. If you are not familiar with circuit modeling, it is recommended that you review the [Theory for the Electrical Circuit Interface](#).

In general electrical circuits connect to other physics interfaces via one or more of three special circuit features:

- [External I vs. U](#)
- [External U vs. I](#)
- [External I-Terminal](#)

These features either accept a voltage measurement from the connecting noncircuit physics interface and return a current from an Electrical Circuit interface or the other way around.



The “External” features are considered “ideal” current or voltage sources by the Electrical Circuit interface. Hence, you cannot connect them directly in parallel (voltage sources) or in series (current sources) with other ideal sources. This results in the error message *The DAE is structurally inconsistent*. A workaround is to provide a suitable parallel or series resistor, which can be tuned to minimize its influence on the results.

---

### *Connecting Electrical Circuits Using Predefined Couplings*

---

In addition to these circuit features, interfaces in the AC/DC Module, RF Module, MEMS Module, Plasma Module, and Semiconductor Module (the modules that include the Electrical Circuit interface) also contain features that provide couplings to the Electrical Circuit interface by accepting a voltage or a current from one of the specific circuit features ([External I vs. U](#), [External U vs. I](#), and [External I-Terminal](#)).

This coupling is typically activated when:

- A choice is made in the **Settings** window for the noncircuit physics interface feature, which then announces (that is, includes) the coupling to the Electrical Circuit interface. Its voltage or current is then included to make it visible to the connecting circuit feature.
- A voltage or current that has been announced (that is, included) is selected in a feature node’s **Settings** window.

These circuit connections are supported in Lumped Ports.

---

### *Connecting Electrical Circuits by User-Defined Couplings*

---

A more general way to connect a physics interface to the Electrical Circuit interface is to:

- Apply the voltage or current from the connecting “External” circuit feature as an excitation in the noncircuit physics interface.

- Define your own voltage or current measurement in the noncircuit physics interface using variables, coupling operators and so forth.
- In the **Settings** window for the Electrical Circuit interface feature, selecting the User-defined option and entering the name of the variable or expression using coupling operators defined in the previous step.

### DETERMINING A CURRENT OR VOLTAGE VARIABLE NAME

To determine a current or voltage variable name, look at the **Dependent Variables** node under the **Study** node. To do this:

- 1 In the **Model Builder**, right-click the **Study** node and select **Show Default Solver**.
- 2 Expand the **Solver>Dependent Variables** node and click the state node, in this example, **Current through device R1 (comp1.currents)**. The variable name is shown in the **Settings** window for **State**.

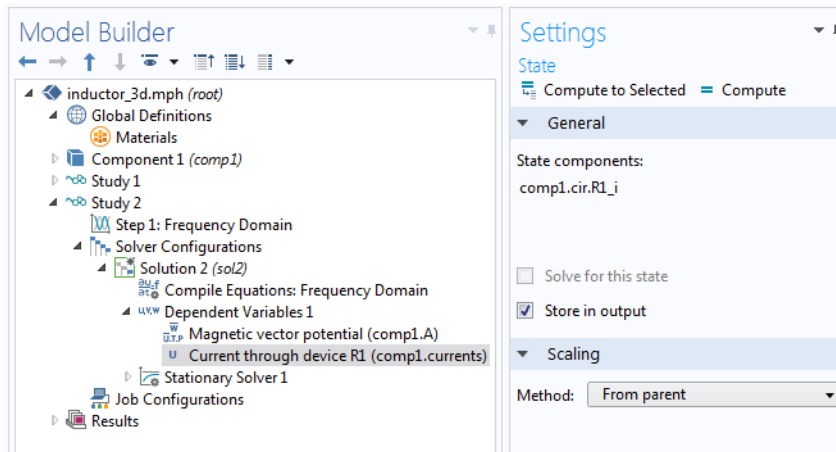

Typically, voltage variables are named `cir.Xn_v` and current variables `cir.Xn_i`, where  $n$  is the “External” device number — 1, 2, and so on.

## Solving

---



Some modeling errors lead to the error message *The DAE is structurally inconsistent* being displayed when solving. This error typically occurs from having an open current loop, from connecting voltage sources in parallel, or connecting current sources in series.

In this respect, the predefined coupling features are also treated as (ideal) voltage or current sources. The remedy is to close current loops and to connect resistors in series with voltage sources or in parallel with current sources.

---

## Postprocessing

---

The Electrical Circuits interface, unlike most of the other physics interfaces, solves for a relatively large number of global dependent variables (such as voltages and currents), instead of solving for a few space-varying fields (such as temperature or displacement). For this reason, the Electrical Circuit interface does not provide default plots when computing a study.

The physics interface defines a number of variables that can be used in postprocessing. All variables defined by the Electrical Circuit interface are of a global scope, and can be evaluated in a **Global Evaluation** node (under **Derived Values**). In addition, the time evolution or dependency on a parameter can be plotted in a **Global** plot (under a **ID Plot Group** node).

The physics interface defines a Node voltage variable for each electrical node in the circuit, with name `cir.v_name`, where `cir` is the physics interface Label and `<name>` is the node Name. For each two-pin component, the physics interface also defines variables containing the voltage across it and the current flowing through it.



In the *COMSOL Multiphysics Reference Manual*:

- [Derived Values, Evaluation Groups, and Tables and Global Evaluation](#)
  - [Plot Groups and Plots and Global](#)
-



# SPICE Import and Export

## *SPICE Import*

---

The circuit definition in COMSOL Multiphysics adheres to the SPICE format developed at the University of California, Berkeley (Ref. 1). SPICE netlists can be imported and the corresponding circuit nodes are generated in the COMSOL Multiphysics model. Most circuit simulators can export to this format or some version of it.

The Electrical Circuit interface supports the following device models:

TABLE 2-3: SUPPORTED SPICE DEVICE MODELS

STATEMENT	DEVICE MODEL
R	Resistor
C	Capacitor
L	Inductor
V	Voltage Source
I	Current Source
E	Voltage-Controlled Voltage Source
F	Current-Controlled Current Source
G	Voltage-Controlled Current Source
H	Current-Controlled Voltage Source
D	Diode
Q	NPN BJT and PNP BJT
M	n-Channel MOSFET and p-Channel MOSFET
X	Subcircuit Instance

Statements corresponding to multiple devices are resolved by parsing the associated `.model` statement. The physics interface also supports the `.subckt` statement, which is represented in COMSOL by a [Subcircuit Definition](#) node, and the `.include` statement. SPICE commands are interpreted case-insensitively. The statement defining each device is also interpreted as the **Device name**.

According to SPICE specification, the first line in the netlist file is assumed to be the title of the netlist and it is ignored by the parser.

## *SPICE Export*

---

The **SPICE Export** functionality creates a SPICE netlist file containing a description of the circuit represented by the physics interface. This functionality can be accessed from the physics interface context menu (right-click the physics interface node and select **Export SPICE Netlist**). After specifying a filename, the circuit is exported and messages from the export process display in the **Messages** window. During the export process, a series of operations are performed:

- In order to avoid conflicts, each component must be identified by a unique **Device name**. If one or more components have the same device name, the export operation fails and an error message is displayed. All characters in a **Device name** that are not letters, digits or underscores are replaced by underscores.
- According to the SPICE specification, each circuit must have a node with name 0, which is assumed to be the only ground node. When exporting a circuit, any node with name 0 that is not connected to a **Ground** component is exported with a different node name. All nodes that are connected to a Ground components are exported as a merged node with name 0. The Messages window shows a log message if these operations are performed, showing the name of the renamed or merged nodes.
- All characters in node names that are not letters, digits or underscores are replaced by underscores.
- Some components (most notably, the **External** components used to couple to other physics interfaces) cannot be exported to a SPICE netlist. These components are ignored during the export process, and a message is shown in the Messages window. Note that this can change the exported circuit, since some components are then missing.
- Subcircuit definitions are added as `.subckt` statements in the netlist. Semiconductor devices (such as MOSFETs, BJTs, and diodes) are exported as a SPICE device with a corresponding `.model` statement.

The title of the exported netlist file is the model's filename, and the time, date, and version of COMSOL Multiphysics is added as a comment in the netlist file.

## *Reference*

---

1. <http://bwrc.eecs.berkeley.edu/Classes/IcBook/SPICE/>

# Reduced-Order Modeling

When designing bandpass-filter type high-Q devices in the frequency domain, it may be necessary to apply many frequency samples to describe the passband accurately. The reduced-order modeling technique can help accelerate the modeling of such devices as a fine frequency resolution can be used for a modest simulation time.

Two simulation methods: the asymptotic waveform evaluation (AWE) and frequency-domain modal methods, both are designed to help overcome the conventional issue of a longer simulation time when using a very fine frequency resolution or running a very wideband simulation. The AWE is efficient when it comes to describing smooth frequency responses with a single resonance or no resonance at all. The frequency-domain modal method, meanwhile, is useful for quickly analyzing multistage filters or filters of a high number of elements that have multiple resonances in a target passband.

In this section:

- [Adaptive Frequency Sweep Using Asymptotic Waveform Evaluation \(AWE\) Method](#)
- [Frequency Domain, Modal Method](#)



[Adaptive Frequency Sweep and Frequency Domain, Modal in the COMSOL Multiphysics Reference Manual](#)

---

## *Adaptive Frequency Sweep Using Asymptotic Waveform Evaluation (AWE) Method*

---

The AWE method is very useful when simulating resonant circuits, especially single-resonance bandpass-filter type devices with many frequency points. When using the **Adaptive Frequency Sweep** study, the simulation time with a much finer frequency resolution can be almost the same as a coarse resolution regular **Frequency Domain** simulation.

## CHOOSING APPROPRIATE ASYMPTOTIC WAVEFORM EVALUATION (AWE) EXPRESSIONS

The simulation time may vary depending on the user input for the **AWE expressions**. Any model variable works as an AWE expression, so long as it has a smooth curve shape like a Gaussian pulse as a function of frequency. The absolute value of  $S_{21}$ , `abs(comp1.emw.S21)`, often works as the input for the AWE expression in the case of two-port bandpass filters. For one-port devices like antennas, the absolute value of  $S_{11}$  is a good choice. If the frequency response of the AWE expression contains an infinite gradient — the case for the  $S_{11}$  value of an antenna with excellent impedance matching at a single frequency point — the simulation will take longer to complete because it requires many data points to describe the sharp dip. When the loss in a one-port device is negligible, an alternative expression such as `sqrt(1-abs(comp1.emw.S11)^2)` may work more efficiently than using `abs(comp1.emw.S11)` directly.

## DATA MANAGEMENT

With a very fine frequency step simulation, the solutions contain a lot of data. As a result, the model file size will increase tremendously when it is saved. By selecting the **Store fields in output** check box in the **Values of Dependent Variables** section of the **Frequency Domain** study step settings, it is possible to define for what part of the model the computed solution should be saved. When only S-parameters are of interest, it is not necessary to store all of the field solutions. Instead, only store the field on the selections for the port and lumped port boundaries, as those will be used for the S-parameter calculations.

In the **Values of Dependent Variables** section, change the selection in the **Store fields in output** combo box from **All** to **For selections** and then add the explicit selections that include the port and lumped port boundaries. The explicit selection can be easily created from the port and lumped port feature by clicking **Create Selection** icon in the **Boundary Selection** settings once the selection is specified.

## AWE CONFIGURATION IN FREQUENCY DOMAIN STUDY STEP SETTINGS

The solver performs fast adaptive frequency sweeping using an AWE method. To trigger the AWE in a **Frequency Domain** study, the following steps are required:

- Expand **Study Extensions** section in **Frequency Domain** study step settings.

- Click the **Use asymptotic waveform evaluation** check box in the **Study Extensions** section.
- Specify the user input for the **AWE expressions**.



*Evanescent Mode Cylindrical Cavity Filter*: Application Library path **RF\_Module/Filters/cylindrical\_cavity\_filter\_evanescent**

*RF Coil*: Application Library path **RF\_Module/Passive\_Devices/rf\_coil**

### *Frequency Domain, Modal Method*

Bandpass-frequency responses of a passive circuit often result from a combination of multiple resonances. **Eigenfrequency** analysis is used for capturing the resonance frequencies of a device. In a subsequent step, the information from the **Eigenfrequency** solutions can be reused in a **Frequency Domain, Modal** study to generate a solution for the driven problem.

#### **EIGENFREQUENCY STUDY STEP SETTINGS**

To perform a **Frequency Domain, Modal** analysis, it is necessary to configure the **Eigenfrequency** study step properly. As the output of the **Eigenfrequency** study may include unphysical results (so called spurious modes), appropriate settings help refine the **Eigenfrequency** study results.

- Set **Eigenfrequency search method** to **Manual**
- Adjust **Desired number of eigenfrequencies** if necessary.
- Set **Search for eigenfrequencies around** to the estimate of the lowest passband frequency.
- Set **Eigenfrequency search method around shift** to **Larger real part**.

#### **DATA MANAGEMENT**

The **Store fields in output** check box in the **Values of Dependent Variables** section can be applied to the **Frequency Domain, Modal** study — if you are interested only in

S-parameters. By storing solutions only on port or lumped port boundaries, the saved model file size will decrease a lot.



Note that the phase of the computed S-parameters in the **Frequency Domain, Modal** study can be different from that of the regular frequency sweep model due to that all relevant eigenmodes might not be included in the simulation. It is recommended to perform an initial eigenfrequency investigation, to find all relevant eigenfrequencies contributing to the frequency response. If not all relevant eigenfrequencies are included in the simulation, the results are compatible only for phase-independent S-parameter values, such as dB-scaled, absolute value, reflectivity, or transmittivity.



*Cascaded Rectangular Cavity Filter*: Application Library path **RF\_Module/Filters/cascaded\_cavity\_filter**

*Coupled-Line Bandpass Filter*: Application Library path **RF\_Module/Filters/coupled\_line\_filter**

*Coplanar Waveguide Bandpass Filter*: Application Library path **RF\_Module/Filters/cpw\_bandpass\_filter**

# Part Libraries

In RF simulations, it is often necessary to set up identical geometry sequences, such as connectors, multiple times. This can be conveniently accomplished using the Part Library for the RF Module.

The Part Library contains complex shapes, frequently required for RF simulations, including the following parts:

- Connectors
- Surface mount devices
- Waveguides

The parts are built from partially parameterized sequences of geometry instructions. For example, you can load the `connector_sma_flange2` part into a model and then specify the outer and inner radii of the coaxial structure. RF parts usually include selections for the conductive boundary that make it easy to apply PEC boundary conditions while setting up the physics.



The following RF tutorials use the Part Library to create their geometry sequences:

- *Branch-Line Coupler*: Application Library path **RF\_Module/Couplers\_and\_Power\_Dividers/branch\_line\_coupler**
- *SMA Connectorized Wilkinson Power Divider*: Application Library path **RF\_Module/Couplers\_and\_Power\_Dividers/wilkinson\_power\_divider**



[Part Libraries](#) in the *COMSOL Multiphysics Reference Manual*.

---

# Material Libraries

The RF Module features a Material Library with material properties for substrate materials to assist in modeling RF, microwave, and millimeter-wave circuit boards.

The RF Material Library contains the material property data from following companies' products:

## **ROGERS CORPORATION**

RO4000® Laminates, RT/duroid® Laminates, RO3000® Laminates, XT/duroid® Copper Clad Laminates, TMM® Laminates, TC Series® Laminates, Kappa® 438 Laminates, CuClad® & IsoClad® Series Laminate, DiClad® Series Laminates, CLTE Series® Materials, AD Series® Laminates, and Bondply/Prepreg

See <https://www.rogerscorp.com> for more information.

## **ISOLA GROUP**

185HR, 254, 370 TURBO®, 370HR, A11, Astra® MT77, DE104, ED130UV, FR402, FR406, FR406N, FR408, FR408HR, G200, I-Speed®, I-Tera® MT40, I-Tera® MT40 (RF/MW), IS300MD, IS400, IS400HR, IS410, IS415, IS420, IS680, IS680 AG, IS680 AG -348, P25N, P95/P25, P96/P26, Tachyon® 100G, TerraGreen®, and TerraGreen® (RF/MW)

The foregoing materials are the property of Isola Group. For product information concerning such materials, see <https://www.isola-group.com/products/>. For other questions concerning such materials, please contact <https://www.isola-group.com/contact-us/>.

## **AVIENT CORPORATION**

PREPERM® Standard Grades, PREPERM® Radome Grades, PREPERM® High-temperature Grades, PREPERM® Flexible Grades, and PREPERM® H-series Grades

The foregoing materials are the property of Avient Corporation. For product information concerning such materials, see <https://www.preperm.com/products/raw-materials/>. For other questions concerning such materials, please contact <https://www.preperm.com/contact-us/>.



# Electromagnetics Theory

This chapter contains a review of the basic theory of electromagnetics, starting with Maxwell's equations, and the theory for some special calculations: S-parameters, lumped port parameters, and far-field analysis. There is also a list of electromagnetic quantities with their SI units and symbols.

In this chapter:

- [Maxwell's Equations](#)
- [Special Calculations](#)
- [Electromagnetic Quantities](#)

See also:

- [Theory for the Electromagnetic Waves Interfaces](#)
- [Theory for the Electrical Circuit Interface](#)
- [Theory for Heat Transfer](#) in the *COMSOL Multiphysics Reference Manual*

# Maxwell's Equations

In this section:

- [Maxwell's Equations](#)
- [Constitutive Relations](#)
- [Boundary Conditions](#)
- [Potentials](#)
- [Electromagnetic Energy](#)
- [Material Properties](#)
- [Phasors](#)

## *Maxwell's Equations*

---

The problem of electromagnetic analysis on a macroscopic level is that of solving *Maxwell's equations* subject to certain boundary conditions. Maxwell's equations are a set of equations, written in differential or integral form, stating the relationships between the fundamental electromagnetic quantities. These quantities are:

- Electric field intensity  $\mathbf{E}$
- Electric displacement field  $\mathbf{D}$
- Magnetic field intensity  $\mathbf{H}$
- Magnetic flux density  $\mathbf{B}$
- Current density  $\mathbf{J}$
- Electric charge density  $\rho$

For general time-varying fields, Maxwell's equations in the differential form can be written as

$$\begin{aligned}\nabla \cdot \mathbf{D} &= \rho && \text{Gauss' law, electric} \\ \nabla \times \mathbf{E} &= -\frac{\partial \mathbf{B}}{\partial t} && \text{Faraday's law} \\ \nabla \cdot \mathbf{B} &= 0 && \text{Gauss' law, magnetic} \\ \nabla \times \mathbf{H} &= \mathbf{J} + \frac{\partial \mathbf{D}}{\partial t} && \text{Maxwell-Ampère's law}\end{aligned}\tag{3-1}$$

Another fundamental equation, derived from Maxwell's equations, is the *equation of continuity*:

$$\nabla \cdot \mathbf{J} = -\frac{\partial \rho}{\partial t} \quad (3-2)$$

### *Constitutive Relations*

---

To obtain a closed system, the equations include *constitutive relations* that describe the macroscopic properties of the medium. They are given as

$$\begin{aligned} \mathbf{D} &= \varepsilon_0 \mathbf{E} + \mathbf{P} \\ \mathbf{B} &= \mu_0 (\mathbf{H} + \mathbf{M}) \\ \mathbf{J} &= \sigma \mathbf{E} \end{aligned} \quad (3-3)$$

where  $\varepsilon_0$  and  $\mu_0$  are the permittivity and permeability of vacuum, and  $\sigma$  is the electrical conductivity. The constants  $\varepsilon_0$  and  $\mu_0$  are available in COMSOL Multiphysics as predefined physical constants. In the SI unit system,  $\varepsilon_0$  has an approximate value of  $1/(36\pi) \cdot 10^{-9}$  F/m;  $\mu_0$  has an approximate value of  $4\pi \cdot 10^{-7}$  H/m.

The *electric polarization vector*  $\mathbf{P}$  describes how the material is polarized when an electric field  $\mathbf{E}$  is present. It can be interpreted as the volume density of *electric dipole* moments.  $\mathbf{P}$  is generally a function of  $\mathbf{E}$ . Some materials can have a nonzero  $\mathbf{P}$  when there is no electric field present.

The *magnetization vector*  $\mathbf{M}$  similarly describes how the material is magnetized when a magnetic field  $\mathbf{H}$  is present. It can be interpreted as the volume density of *magnetic dipole* moments.  $\mathbf{M}$  is generally a function of  $\mathbf{H}$ . Permanent magnets, for instance, have a nonzero  $\mathbf{M}$  when there is no magnetic field present.

For linear materials, the polarization is directly proportional to the electric field,  $\mathbf{P} = \varepsilon_0 \chi_e \mathbf{E}$ , where  $\chi_e$  is the electric susceptibility. Similarly in linear materials, the magnetization is directly proportional to the magnetic field,  $\mathbf{M} = \chi_m \mathbf{H}$ , where  $\chi_m$  is the magnetic susceptibility. For such materials, the constitutive relations are:

$$\begin{aligned} \mathbf{D} &= \varepsilon_0 (1 + \chi_e) \mathbf{E} = \varepsilon_0 \varepsilon_r \mathbf{E} = \varepsilon \mathbf{E} \\ \mathbf{B} &= \mu_0 (1 + \chi_m) \mathbf{H} = \mu_0 \mu_r \mathbf{H} = \mu \mathbf{H} \end{aligned}$$

The parameter  $\varepsilon_r$  is the relative permittivity and  $\mu_r$  is the relative permeability of the material. Usually these are scalar properties but can, in the general case, be 3-by-3

tensors when the material is anisotropic. The properties  $\epsilon$  and  $\mu$  (without subscripts) are the permittivity and permeability of the material, respectively.

### GENERALIZED CONSTITUTIVE RELATIONS

For nonlinear materials, a generalized form of the constitutive relationships is useful. The relationship used for electric fields is  $\mathbf{D} = \epsilon_0 \epsilon_r \mathbf{E} + \mathbf{D}_r$ , where  $\mathbf{D}_r$  is the *remanent displacement*, which is the displacement when no electric field is present.

Similarly, a generalized form of the constitutive relation for the magnetic field is

$$\mathbf{B} = \mu_0 \mu_r \mathbf{H} + \mathbf{B}_r$$

where  $\mathbf{B}_r$  is the *remanent magnetic flux density*, which is the magnetic flux density when no magnetic field is present.

For some materials, there is a nonlinear relationship between  $\mathbf{B}$  and  $\mathbf{H}$  such that

$$\mathbf{B} = f(|\mathbf{H}|)$$

The relation defining the current density is generalized by introducing an externally generated current  $\mathbf{J}_e$ . The resulting constitutive relation is  $\mathbf{J} = \sigma \mathbf{E} + \mathbf{J}_e$ .

### *Boundary Conditions*

---

To get a full description of an electromagnetics problem, boundary conditions must be specified at material interfaces and physical boundaries. At interfaces between two media, the boundary conditions can be expressed mathematically as

$$\begin{aligned} \mathbf{n}_2 \cdot (\mathbf{D}_1 - \mathbf{D}_2) &= \rho_s \\ \mathbf{n}_2 \times (\mathbf{E}_1 - \mathbf{E}_2) &= \mathbf{0} \\ \mathbf{n}_2 \cdot (\mathbf{B}_1 - \mathbf{B}_2) &= 0 \\ \mathbf{n}_2 \times (\mathbf{H}_1 - \mathbf{H}_2) &= \mathbf{J}_s \end{aligned} \tag{3-4}$$

where  $\rho_s$  and  $\mathbf{J}_s$  denote surface charge density and surface current density, respectively, and  $\mathbf{n}_2$  is the outward normal from medium two.

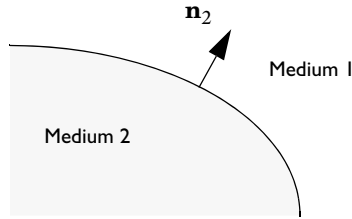

The boundary condition for the current density, derived from Equation 3-4, is expressed as

$$\mathbf{n}_2 \cdot (\mathbf{J}_1 - \mathbf{J}_2) = -\frac{\partial \rho_s}{\partial t}$$

#### INTERFACE BETWEEN A DIELECTRIC AND A PERFECT CONDUCTOR

A perfect conductor has infinite electrical conductivity and thus no internal electric field. Otherwise, it would produce an infinite current density according to the third fundamental constitutive relation. At an interface between a dielectric and a perfect conductor, the boundary conditions for the  $\mathbf{E}$  and  $\mathbf{D}$  fields are simplified. Assume that subscript 1 corresponds to a perfect conductor; then  $\mathbf{D}_1 = \mathbf{0}$  and  $\mathbf{E}_1 = \mathbf{0}$  in the relationships just given. If it is a time-varying case, then  $\mathbf{B}_1 = \mathbf{0}$  and  $\mathbf{H}_1 = \mathbf{0}$  as well, as a consequence of Maxwell's equations. The result is the following set of boundary conditions for the fields in the dielectric medium for the time-varying case:

$$\begin{aligned} -\mathbf{n}_2 \cdot \mathbf{D}_2 &= \rho_s \\ -\mathbf{n}_2 \times \mathbf{E}_2 &= 0 \\ -\mathbf{n}_2 \cdot \mathbf{B}_2 &= 0 \\ -\mathbf{n}_2 \times \mathbf{H}_2 &= \mathbf{J}_s \end{aligned} \tag{3-5}$$

#### *Potentials*

Under certain circumstances, it can be helpful to formulate the problems in terms of the electric scalar potential  $V$  and the magnetic vector potential  $\mathbf{A}$ . They are given by the equalities

$$\mathbf{B} = \nabla \times \mathbf{A}$$

$$\mathbf{E} = -\nabla V - \frac{\partial \mathbf{A}}{\partial t}$$

The defining equation for the magnetic vector potential is a direct consequence of the magnetic Gauss' law. The electric potential results from Faraday's law.

### *Electromagnetic Energy*

---

The electric and magnetic energies are defined as

$$W_e = \int_V \left( \int_0^D \mathbf{E} \cdot d\mathbf{D} \right) dV = \int_V \left( \int_0^T \mathbf{E} \cdot \frac{\partial \mathbf{D}}{\partial t} dt \right) dV$$

$$W_m = \int_V \left( \int_0^B \mathbf{H} \cdot d\mathbf{B} \right) dV = \int_V \left( \int_0^T \mathbf{H} \cdot \frac{\partial \mathbf{B}}{\partial t} dt \right) dV$$

The time derivatives of these expressions are the electric and magnetic power:

$$P_e = \int_V \mathbf{E} \cdot \frac{\partial \mathbf{D}}{\partial t} dV$$

$$P_m = \int_V \mathbf{H} \cdot \frac{\partial \mathbf{B}}{\partial t} dV$$

These quantities are related to the resistive and radiative energy, or energy loss, through Poynting's theorem (Ref. 3):

$$-\int_V \left( \mathbf{E} \cdot \frac{\partial \mathbf{D}}{\partial t} + \mathbf{H} \cdot \frac{\partial \mathbf{B}}{\partial t} \right) dV = \int_V \mathbf{J} \cdot \mathbf{E} dV + \oint_S (\mathbf{E} \times \mathbf{H}) \cdot \mathbf{n} dS$$

where  $V$  is the computation domain and  $S$  is the closed boundary of  $V$ .

The first term on the right-hand side represents the resistive losses,

$$P_h = \int_V \mathbf{J} \cdot \mathbf{E} dV$$

which result in heat dissipation in the material. (The current density  $\mathbf{J}$  in this expression is the one appearing in Maxwell–Ampère's law.)

The second term on the right-hand side of Poynting's theorem represents the radiative losses

$$P_r = \oint_S (\mathbf{E} \times \mathbf{H}) \cdot \mathbf{n} dS$$

The quantity  $\mathbf{S} = \mathbf{E} \times \mathbf{H}$  is called the Poynting vector.

Under the assumption that the material is linear and isotropic, it holds that

$$\begin{aligned}\mathbf{E} \cdot \frac{\partial \mathbf{D}}{\partial t} &= \epsilon \mathbf{E} \cdot \frac{\partial \mathbf{E}}{\partial t} = \frac{\partial}{\partial t} \left( \frac{1}{2} \epsilon \mathbf{E} \cdot \mathbf{E} \right) \\ \mathbf{H} \cdot \frac{\partial \mathbf{B}}{\partial t} &= \frac{1}{\mu} \mathbf{B} \cdot \frac{\partial \mathbf{B}}{\partial t} = \frac{\partial}{\partial t} \left( \frac{1}{2\mu} \mathbf{B} \cdot \mathbf{B} \right)\end{aligned}$$

By interchanging the order of differentiation and integration (justified by the fact that the volume is constant and the assumption that the fields are continuous in time), the result is

$$-\frac{\partial}{\partial t} \int_V \left( \frac{1}{2} \epsilon \mathbf{E} \cdot \mathbf{E} + \frac{1}{2\mu} \mathbf{B} \cdot \mathbf{B} \right) dV = \int_V \mathbf{J} \cdot \mathbf{E} dV + \oint_S (\mathbf{E} \times \mathbf{H}) \cdot \mathbf{n} dS$$

The integrand of the left-hand side is the total electromagnetic energy density:

$$w = w_e + w_m = \frac{1}{2} \epsilon \mathbf{E} \cdot \mathbf{E} + \frac{1}{2\mu} \mathbf{B} \cdot \mathbf{B}$$

### *Material Properties*

---

Until now, there has only been a formal introduction of the constitutive relations. These seemingly simple relations can be quite complicated at times. There are four main groups of materials for which they require some consideration. A given material can belong to one or more of these groups.

#### **INHOMOGENEOUS MATERIALS**

Inhomogeneous materials are the least complicated. An inhomogeneous medium is one in which the constitutive parameters vary with the space coordinates so that different field properties prevail at different parts of the material structure.

#### **ANISOTROPIC MATERIALS**

For anisotropic materials, the field relationships at any point differ for different directions of propagation. This means that a 3-by-3 tensor is necessary to properly define the constitutive relationships. If this tensor is symmetric, the material is often referred to as *reciprocal*. In such cases, rotate the coordinate system such that a diagonal matrix results. If two of the diagonal entries are equal, the material is *uniaxially anisotropic*. If none of the elements have the same value, the material is *biaxially anisotropic* (Ref. 2). Anisotropic parameters are needed, for example, to

examine permittivity in crystals (Ref. 2) and when working with conductivity in solenoids.

### **NONLINEAR MATERIALS**

Nonlinearity is the effect of variations in permittivity or permeability with the intensity of the electromagnetic field. Nonlinearity also includes hysteresis effects where not only the current field intensities influence the physical properties of the material, but also the history of the field distribution.

### **DISPERSIVE MATERIALS**

Dispersion describes changes in a wave's velocity with wavelength. In the frequency domain, dispersion is expressed with a frequency dependence of the constitutive relations.

### **MATERIAL PROPERTIES AND THE MATERIAL BROWSER**

All interfaces in the RF Module support the use of the COMSOL Multiphysics material libraries. The typical electromagnetic material properties that can be stored are:

- The electrical conductivity
- The relative permittivity
- The relative permeability

The physics-specific domain material properties are by default taken from the material specification. The material properties are inputs to material laws or constitutive relations that are defined on the feature level below the physics interface node in the model tree. There is one editable default domain feature that initially represents a linear isotropic material. Domains with different material laws are specified by adding additional features. Some of the domain parameters can either be a scalar or a matrix (tensor) depending on whether the material is isotropic or anisotropic.

In a similar way, boundary, edge, and point settings are specified by adding the corresponding features. A certain feature might require one or several fields to be specified, while others generate the conditions without user-specified fields.



For detailed information about [Materials](#) and [Modeling Anisotropic Materials](#), including the [Electromagnetic Models](#), see the *COMSOL Multiphysics Reference Manual*.

---



## Phasors

---

Whenever a problem is time-harmonic the fields can be written in the form

$$\mathbf{E}(\mathbf{r}, t) = \hat{\mathbf{E}}(\mathbf{r}) \cos(\omega t + \phi)$$

Instead of using a cosine function for the time dependence, it is more convenient to use an exponential function, by writing the field as

$$\mathbf{E}(\mathbf{r}, t) = \hat{\mathbf{E}}(\mathbf{r}) \cos(\omega t + \phi) = \text{Re}(\hat{\mathbf{E}}(\mathbf{r})e^{j\phi}e^{j\omega t}) = \text{Re}(\tilde{\mathbf{E}}(\mathbf{r})e^{j\omega t})$$

The field  $\tilde{\mathbf{E}}(\mathbf{r})$  is a *phasor*, which contains amplitude and phase information of the field but is independent of  $t$ . One thing that makes the use of phasors suitable is that a time derivative corresponds to a multiplication by  $j\omega$ :

$$\frac{\partial \mathbf{E}}{\partial t} = \text{Re}(j\omega \tilde{\mathbf{E}}(\mathbf{r})e^{j\omega t})$$

If the fields satisfy a linear time-dependent equation, then the corresponding phasors must satisfy a similar equation in which the time derivatives are replaced by a factor  $j\omega$ . All time-harmonic equations are expressed as equations for the phasors. (The tilde is dropped from the variable denoting the phasor.)

The frequency domain formulation is only applicable for equations linear in the fields. In particular, it cannot be used with materials whose properties depend on the fields themselves (nonlinear materials).



When analyzing the solution of a time-harmonic equation, it is important to remember that the field that has been calculated is a phasor and not a physical field.

For example, all plot functions visualize  $\text{Re}(\tilde{\mathbf{E}}(\mathbf{r}))$  by default, which is  $\mathbf{E}$  at time  $t = 0$ . To obtain the solution at a given time, specify a phase factor in all results settings and in the corresponding functions.

---

# Special Calculations

In this section:

- [S-Parameter Calculations](#)
- [Far-Field Calculations Theory](#)
- [References](#)



Lumped Ports with Voltage Input

---

## *S-Parameter Calculations*

---

For high-frequency problems, voltage is not a well-defined entity, and it is necessary to define the scattering parameters (S-parameter) in terms of the electric field. To convert an electric field pattern on a port to a scalar complex number corresponding to the voltage in transmission line theory an eigenmode expansion of the electromagnetic fields on the ports needs to be performed. Assume that an eigenmode analysis has been performed on the ports 1, 2, 3, ... and that the electric field patterns  $\mathbf{E}_1, \mathbf{E}_2, \mathbf{E}_3, \dots$  of the fundamental modes on these ports are known. Further, assume that the fields are normalized with respect to the integral of the power flow across each port cross section, respectively. This normalization is frequency dependent unless TEM modes are being dealt with. The port excitation is applied using the fundamental eigenmode, the mode with subscript 1. The computed electric field  $\mathbf{E}_c$  on the port consists of the excitation plus the reflected field. That is, on the port boundary where there is an incident wave, the computed field can be expanded in terms of the mode fields as

$$\mathbf{E}_c = \mathbf{E}_1 + \sum_{i=1} S_{i1} \mathbf{E}_i,$$

whereas on all other port boundaries, the computed field is given by

$$\mathbf{E}_c = \sum_{i=1} S_{i1} \mathbf{E}_i$$

The S-parameter for the mode with index  $k$  is then given by multiplying with the conjugate of the mode field for mode  $k$  and integrating over the port boundary. Since the mode fields for the different modes are orthogonal, the following relations are obtained for the S-parameters

$$S_{11} = \frac{\int_{\text{port 1}} ((\mathbf{E}_c - \mathbf{E}_1) \cdot \mathbf{E}_1^*) dA_1}{\int_{\text{port 1}} (\mathbf{E}_1 \cdot \mathbf{E}_1^*) dA_1}$$

$$S_{21} = \frac{\int_{\text{port 2}} (\mathbf{E}_c \cdot \mathbf{E}_2^*) dA_2}{\int_{\text{port 2}} (\mathbf{E}_2 \cdot \mathbf{E}_2^*) dA_2}$$

$$S_{31} = \frac{\int_{\text{port 3}} (\mathbf{E}_c \cdot \mathbf{E}_3^*) dA_3}{\int_{\text{port 3}} (\mathbf{E}_3 \cdot \mathbf{E}_3^*) dA_3}$$

and so on. To get  $S_{22}$  and  $S_{12}$ , excite port number 2 in the same way.

#### POWER FLOW NORMALIZATION

The fields  $\mathbf{E}_1$ ,  $\mathbf{E}_2$ ,  $\mathbf{E}_3$ , and so on, should be normalized such that they represent the same power flow through the respective ports. The power flow is given by the time-average Poynting vector,

$$\mathbf{S}_{\text{av}} = \frac{1}{2} \text{Re}(\mathbf{E} \times \mathbf{H}^*)$$

The amount of power flowing out of a port is given by the normal component of the Poynting vector,

$$\mathbf{n} \cdot \mathbf{S}_{\text{av}} = \mathbf{n} \cdot \frac{1}{2} \text{Re}(\mathbf{E} \times \mathbf{H}^*)$$

Below the *cutoff frequency* the power flow is zero, which implies that it is not possible to normalize the field with respect to the power flow below the cutoff frequency. But in this region the S-parameters are trivial and do not need to be calculated.

In the following subsections the power flow is expressed directly in terms of the electric field for TE, TM, and TEM waves.

### TE Waves

For TE waves it holds that

$$\mathbf{E} = -Z_{\text{TE}}(\mathbf{n} \times \mathbf{H})$$

where  $Z_{\text{TE}}$  is the wave impedance

$$Z_{\text{TE}} = \frac{\omega\mu}{\beta}$$

$\omega$  is the angular frequency of the wave,  $\mu$  the permeability, and  $\beta$  the propagation constant. The power flow then becomes

$$\mathbf{n} \cdot \mathbf{S}_{\text{av}} = \frac{1}{2} \mathbf{n} \cdot \text{Re}(\mathbf{E} \times \mathbf{H}^*) = -\frac{1}{2} \text{Re}(\mathbf{E} \cdot (\mathbf{n} \times \mathbf{H}^*)) = \frac{1}{2Z_{\text{TE}}} |\mathbf{E}|^2$$

### TM Waves

For TM waves it holds that

$$\mathbf{H} = \frac{1}{Z_{\text{TM}}}(\mathbf{n} \times \mathbf{E})$$

where  $Z_{\text{TM}}$  is the wave impedance

$$Z_{\text{TM}} = \frac{\beta}{\omega\epsilon}$$

and  $\epsilon$  is the permittivity. The power flow then becomes

$$\begin{aligned} \mathbf{n} \cdot \mathbf{S}_{\text{av}} &= \frac{1}{2} \mathbf{n} \cdot \text{Re}(\mathbf{E} \times \mathbf{H}^*) = \frac{1}{2Z_{\text{TM}}} (\mathbf{n} \cdot \text{Re}(\mathbf{E} \times (\mathbf{n} \times \mathbf{E}^*))) \\ &= \frac{1}{2Z_{\text{TM}}} |\mathbf{n} \times \mathbf{E}|^2 \end{aligned}$$

### TEM Waves

For TEM waves it holds that

$$\mathbf{H} = \frac{1}{Z_{\text{TEM}}}(\mathbf{n} \times \mathbf{E})$$

where  $Z_{\text{TEM}}$  is the wave impedance

$$Z_{\text{TEM}} = \sqrt{\frac{\mu}{\epsilon}}$$

The power flow then becomes

$$\mathbf{n} \cdot \mathbf{S}_{\text{av}} = \frac{1}{2} \mathbf{n} \cdot \text{Re}(\mathbf{E} \times \mathbf{H}^*) = \frac{1}{2Z_{\text{TEM}}} |\mathbf{n} \times \mathbf{E}|^2 = \frac{1}{2Z_{\text{TEM}}} |\mathbf{E}|^2$$

where the last equality holds because the electric field is tangential to the port.

### *Far-Field Calculations Theory*

---

The far field from, for example, antennas can be calculated from the near field using the Stratton–Chu formula. In 3D, this is:

$$\mathbf{E}_p = \frac{jk}{4\pi} \mathbf{r}_0 \times \int_S [\mathbf{n} \times \mathbf{E} - \eta \mathbf{r}_0 \times (\mathbf{n} \times \mathbf{H})] \exp(jk \mathbf{r} \cdot \mathbf{r}_0) dS$$

and in 2D it looks slightly different:

$$\mathbf{E}_p = \sqrt{j\lambda} \frac{k}{4\pi} \mathbf{r}_0 \times \int_S [\mathbf{n} \times \mathbf{E} - \eta \mathbf{r}_0 \times (\mathbf{n} \times \mathbf{H})] \exp(jk \mathbf{r} \cdot \mathbf{r}_0) dS$$

In both cases the integration is performed on a closed boundary. In the scattered field formulation, where the total electric field is the sum of the background field and the scattered field, the far field only gets contributions from the scattered field, since the contributions from the background field cancel out when integrated over all parts of the closed boundary.

The Stratton-Chu formula is based on the assumption that the Green’s function for the vector Helmholtz equation for the far-field domain is known. The Green’s function used in COMSOL is based on the assumption that the far-field domain material is homogeneous. Thus, if inhomogeneous materials are used in the far-field domain an error will be displayed.

For scattering problems, the far field in COMSOL Multiphysics is identical to what in physics is known as the “scattering amplitude”.

The antenna is located in the vicinity of the origin, while the far-field point  $p$  is taken at infinity but with a well-defined angular position  $(\theta, \varphi)$ .

In the above formulas,

- $\mathbf{E}$  and  $\mathbf{H}$  are the fields on the “aperture” — the surface  $S$  enclosing the antenna.
- $\mathbf{r}_0$  is the unit vector pointing from the origin to the field point  $p$ . If the field points lie on a spherical surface  $S'$ ,  $\mathbf{r}_0$  is the unit normal to  $S'$ .

- $\mathbf{n}$  is the unit normal to the surface  $S$ .
- $\eta$  is the impedance:

$$\eta = \sqrt{\mu/\epsilon}$$

- $k$  is the wave number.
- $\lambda$  is the wavelength.
- $\mathbf{r}$  is the radius vector (not a unit vector) of the surface  $S$ .
- $\mathbf{E}_p$  is the calculated far field in the direction from the origin toward point  $p$ .

Thus the unit vector  $\mathbf{r}_0$  can be interpreted as the direction defined by the angular position  $(\theta, \varphi)$  and  $\mathbf{E}_p$  is the far field in this direction.

Because the far field is calculated in free space, the magnetic field at the far-field point is given by

$$\mathbf{H}_p = \frac{\mathbf{r}_0 \times \mathbf{E}_p}{\eta_0}$$

The Poynting vector gives the power flow of the far field:

$$\mathbf{r}_0 \cdot \mathbf{S} = \mathbf{r}_0 \cdot \text{Re}(\mathbf{E}_p \times \mathbf{H}_p^*) \sim |\mathbf{E}_p|^2$$

Thus the relative far-field radiation pattern is given by plotting  $|\mathbf{E}_p|^2$ .



For more information about to calculate the far field in certain points, see the blog [2 Methods for Simulating Radiated Fields in COMSOL Multiphysics®](#)

---

### References

---

1. D.K. Cheng, *Field and Wave Electromagnetics*, 2nd ed., Addison-Wesley, 1991.
2. Jianming Jin, *The Finite Element Method in Electromagnetics*, 2nd ed., Wiley-IEEE Press, 2002.
3. A. Kovetz, *The Principles of Electromagnetic Theory*, Cambridge University Press, 1990.
4. R.K. Wangsness, *Electromagnetic Fields*, 2nd ed., John Wiley & Sons, 1986.

# Electromagnetic Quantities

Table 3-1 shows the symbol and SI unit for most of the physical quantities that are included with this module.

TABLE 3-1: ELECTROMAGNETIC QUANTITIES

QUANTITY	SYMBOL	UNIT	ABBREVIATION
Angular frequency	$\omega$	radian/second	rad/s
Attenuation constant	$\alpha$	meter <sup>-1</sup>	m <sup>-1</sup>
Capacitance	$C$	farad	F
Charge	$q$	coulomb	C
Charge density (surface)	$\rho_s$	coulomb/meter <sup>2</sup>	C/m <sup>2</sup>
Charge density (volume)	$\rho$	coulomb/meter <sup>3</sup>	C/m <sup>3</sup>
Current	$I$	ampere	A
Current density (surface)	$\mathbf{J}_s$	ampere/meter	A/m
Current density (volume)	$\mathbf{J}$	ampere/meter <sup>2</sup>	A/m <sup>2</sup>
Electric displacement	$\mathbf{D}$	coulomb/meter <sup>2</sup>	C/m <sup>2</sup>
Electric field	$\mathbf{E}$	volt/meter	V/m
Electric potential	$V$	volt	V
Electric susceptibility	$\chi_e$	(dimensionless)	–
Electrical conductivity	$\sigma$	siemens/meter	S/m
Energy density	$W$	joule/meter <sup>3</sup>	J/m <sup>3</sup>
Force	$\mathbf{F}$	newton	N
Frequency	$\nu$	hertz	Hz
Impedance	$Z, \eta$	ohm	$\Omega$
Inductance	$L$	henry	H
Magnetic field	$\mathbf{H}$	ampere/meter	A/m
Magnetic flux	$\Phi$	weber	Wb
Magnetic flux density	$\mathbf{B}$	tesla	T
Magnetic potential (scalar)	$V_m$	ampere	A
Magnetic potential (vector)	$\mathbf{A}$	weber/meter	Wb/m
Magnetic susceptibility	$\chi_m$	(dimensionless)	–
Magnetization	$\mathbf{M}$	ampere/meter	A/m

TABLE 3-1: ELECTROMAGNETIC QUANTITIES

QUANTITY	SYMBOL	UNIT	ABBREVIATION
Permeability	$\mu$	henry/meter	H/m
Permittivity	$\epsilon$	farad/meter	F/m
Polarization	$\mathbf{P}$	coulomb/meter <sup>2</sup>	C/m <sup>2</sup>
Poynting vector	$\mathbf{S}$	watt/meter <sup>2</sup>	W/m <sup>2</sup>
Propagation constant	$\beta$	radian/meter	rad/m
Reactance	$X$	ohm	$\Omega$
Relative permeability	$\mu_r$	(dimensionless)	–
Relative permittivity	$\epsilon_r$	(dimensionless)	–
Resistance	$R$	ohm	W
Resistive loss	$Q$	watt/meter <sup>3</sup>	W/m <sup>3</sup>
Torque	$T$	newton-meter	Nm
Velocity	$\mathbf{v}$	meter/second	m/s
Wavelength	$\lambda$	meter	m
Wave number	$k$	radian/meter	rad/m





# Radio Frequency Interfaces

This chapter discusses the physics interfaces found under the **Radio Frequency** branch ()

In this chapter:

- The Electromagnetic Waves, Frequency Domain Interface
- The Electromagnetic Waves, Transient Interface
- The Transmission Line Interface
- The Electromagnetic Waves, Time Explicit Interface
- The Electromagnetic Waves, Asymptotic Scattering Interface
- The Electromagnetic Waves, Boundary Elements Interface
- The Electromagnetic Waves, FEM-BEM Interface
- Theory for the Electromagnetic Waves Interfaces
- Theory for the Transmission Line Interface
- Theory for the Electromagnetic Waves, Time Explicit Interface

# The Electromagnetic Waves, Frequency Domain Interface

The **Electromagnetic Waves, Frequency Domain (emw)** interface () is used to solve for time-harmonic electromagnetic field distributions. It is found under the **Radio Frequency** branch () when adding a physics interface.

For this physics interface, the maximum mesh element size should be limited to a fraction of the wavelength. The domain size that can be simulated thus scales with the amount of available computer memory and the wavelength. The physics interface supports the Frequency Domain, Eigenfrequency, Mode Analysis, and Boundary Mode Analysis study types. The Frequency Domain study type is used for source driven simulations for a single frequency or a sequence of frequencies. The Eigenfrequency study type is used to find resonance frequencies and their associated eigenmodes in resonant cavities.

This physics interface solves the time-harmonic wave equation for the electric field.

When this physics interface is added, these default nodes are also added to the **Model Builder** — **Wave Equation, Electric, Perfect Electric Conductor**, and **Initial Values**. Then, from the **Physics** toolbar, add other nodes that implement, for example, boundary conditions. You can also right-click **Electromagnetic Waves, Frequency Domain** to select physics features from the context menu.

The Mode analysis study type is applicable only for 2D and 2D axisymmetric cross sections of waveguides and transmission lines where it is used to find allowed propagating modes. Boundary mode analysis is used for the same purpose in 2D, 2D axisymmetry, and 3D and applies to boundaries representing waveguide ports.

## *Physics-Controlled Mesh*

The physics-controlled mesh is controlled from the **Settings** window for the **Mesh** node (if the **Sequence type** is **Physics-controlled mesh**). In the table in the **Physics-Controlled Mesh** section, find the physics interface in the **Contributor** column and select or clear the check box in the **Use** column on the same row for enabling (the default) or disabling contributions from the physics interface to the physics-controlled mesh.

When the **Use** check box for the physics interface is selected, this invokes a parameter for the maximum mesh element size in free space. The physics-controlled mesh automatically scales the maximum mesh element size as the wavelength changes in

different dielectric and magnetic regions. If the model is configured by any periodic conditions, identical meshes are generated on each pair of periodic boundaries. Perfectly matched layers are built with a structured mesh, specifically, a swept mesh in 3D and a mapped mesh in 2D.

When the **Use** check box is selected for the physics interface, in the section for the physics interface below the table, choose one of the four options for the **Maximum mesh element size control parameter** — **From study** (the default), **User defined**, **Frequency**, or **Wavelength**. When **From study** is selected,  $1/8$  in 2D or  $1/5$  in 3D of the vacuum wavelength from the highest frequency defined in the study step is used for the maximum mesh element size. For the option **User defined**, enter a suitable **Maximum element size in free space**. For example,  $1/5$  of the vacuum wavelength or smaller. When **Frequency** is selected, enter the highest frequency intended to be used during the simulation. The maximum mesh element size in free space is  $1/8$  in 2D and  $1/5$  in 3D of the vacuum wavelength for the entered frequency. For the **Wavelength** option, enter the smallest vacuum wavelength intended to be used during the simulation. The maximum mesh element size in free space is  $1/8$  in 2D and  $1/5$  in 3D of the entered wavelength.

The maximum mesh element sizes discussed above are used with quadratic shape functions. When linear shape functions are used,  $1/2$  of the maximum mesh element size for quadratic shape functions are used. Similarly, when cubic shape functions are used, the maximum mesh element size is 2.25 times the maximum mesh element size for quadratic shape functions.

Furthermore, for Port and Lumped Port features, the maximum mesh element size can be slightly finer than what is discussed above.

When **Resolve wave in lossy media** is selected, the outer boundaries of lossy media domains are meshed with a maximum mesh element size in free space given by the minimum value of half a skin depth and  $1/5$  of the vacuum wavelength.

The maximum mesh element size in dielectric media is equal to the maximum mesh element size in vacuum divided by the square root of the product of the relative permittivity and permeability.

When **Refine conductive edges** is selected, the exterior edges of conductive boundaries, configured by perfect electric conductors, transition boundary, or layered transition boundary conditions, are meshed with a user-specified size. Adjust **Angular tolerance** (SI unit: rad) to include not only edges on flat surfaces but also curved surfaces. Choose **Size type** — **Relative** or **User defined**. For the option **Relative**, the mesh size on the selected edges is defined relative to the default maximum mesh size. On the other

hand, when the option **User defined** is selected, the mesh size is set by user-defined value in the **Size** input field (SI unit: m).

When **Add far-field boundary layers** is selected, the far-field calculation boundaries adjacent to the selection of scattering boundary conditions or perfectly matched layers create a boundary layer mesh with a thickness of 1/40 to the default maximum mesh size.

The material property can be defined by a function, if the function use a single input argument, for example called `freq`, and this variable is also marked as a Frequency Model input in the material property group node where the function is used.



In the *COMSOL Multiphysics Reference Manual* see the [Physics-Controlled Mesh](#) section for more information about how to define the physics-controlled mesh.

## SETTINGS

The **Label** is the default physics interface name.

The **Name** is used primarily as a scope prefix for variables defined by the physics interface. Refer to such physics interface variables in expressions using the pattern `<name>.<variable_name>`. In order to distinguish between variables belonging to different physics interfaces, the `name` string must be unique. Only letters, numbers, and underscores (`_`) are permitted in the **Name** field. The first character must be a letter.

The default **Name** (for the first physics interface in the model) is `emw`.

## FORMULATION

From the **Formulation** list, select whether to solve for the **Full field** (the default) or the **Scattered field**.

For **Scattered field** select a **Background wave type** according to the following table:

TABLE 4-1: BACKGROUND WAVE TYPE BASED ON COMPONENT DIMENSION

COMPONENT	BACKGROUND WAVE TYPE
2D	User defined (default), Gaussian beam
2D Axisymmetric	User defined (default), Circularly polarized plane wave, Linearly polarized plane wave
3D	User defined (default), Gaussian beam, Linearly polarized plane wave

### User Defined

Enter the component expressions for the **Background electric field**  $\mathbf{E}_b$  (SI unit: V/m). The entered expressions must be differentiable.



Notice that expressions including coupling operators are not differentiable and cannot be used as background fields.

### Gaussian Beam

For **Gaussian beam** select the **Gaussian beam type** — **Paraxial approximation** (the default) or **Plane wave expansion**.

When selecting **Paraxial approximation**, the Gaussian beam background field is a solution to the paraxial wave equation, which is an approximation to the Helmholtz equation solved for by the **Electromagnetic Waves, Frequency Domain (emw)** interface. The approximation is valid for Gaussian beams that have a beam radius that is much larger than the wavelength. Since the paraxial Gaussian beam background field is an approximation to the Helmholtz equation, for tightly focused beams, you can get a nonzero scattered field solution, even if you do not have any scatterers. The option **Plane wave expansion** means that the electric field for the Gaussian beam is approximated by an expansion of the electric field into a number of plane waves. Since each plane wave is a solution to the Helmholtz equation, the plane wave expansion of the electric field is also a solution to the Helmholtz equation. Thus, this option can be used also for tightly focused Gaussian beams.

If the beam spot radius is smaller than the wavelength, evanescent plane waves need to be included in the expansion. The evanescent waves decay exponentially in the propagation direction, why it only makes sense to model such tightly focused beams if the focal plane coincides with the input boundary. If the focal plane is located inside the modeled domain, the field can be dominated by the exponentially decaying evanescent waves. Those waves can have a very high field strength before the focal plane even though they only provide a small contribution to the field at the focal plane.

For **Plane wave expansion** select **Wave vector distribution type** — **Automatic** (the default) or **User defined**. For **Automatic** also check **Allow evanescent waves**, to include evanescent waves in the plane wave expansion. For **User defined** also enter values for the **Wave vector count**  $N_{\mathbf{k}}$  (the default value is 13) and **Maximum transverse wave number**  $k_{t,\max}$  (SI unit: rad/m, default value is  $(2 * (\text{sqrt}(2 * \log(10)))) / \text{emw.w0}$ ). Use an odd number for the **Wave vector count**  $N_{\mathbf{k}}$  to make sure that a wave vector pointing in the main propagation direction is included in the plane-wave expansion. The **Wave vector**

**count**  $N_{\mathbf{k}}$  specifies the number of wave vectors that will be included per transverse dimension. So for 3D the total number of wave vectors will be  $N_{\mathbf{k}} \cdot N_{\mathbf{k}}$ .



Evanescent waves are included in the plane wave expansion if the **Maximum transverse wave number**  $k_{t,\max}$  is larger than the specified **Wave number**  $k$ . When the **Wave vector distribution type** is set to **Automatic**, evanescent waves are included in the expansion if the **Allow evanescent waves** check box is selected.

A plane wave expansion with a finite number of plane waves included will make the field periodic in the plane orthogonal to the main propagation direction. If the separation between the transverse wave vector components, given by  $2k_{t,\max}/(N_{\mathbf{k}} - 1)$ , is too small, replicas of the Gaussian beam background field can appear. To avoid that, increase the value for the **Wave vector count**  $N_{\mathbf{k}}$ .

The number of plane waves included in the expansion can be quite large, especially for 3D. For instance, using the default settings,  $2 \cdot 13 \cdot 13 = 338$  plane waves will be included (the factor 2 accounts for the two possible polarizations for each wave vector). Thus, initializing the plane-wave expansion for the Gaussian beam background field can take some time in 3D.

For more information about the Gaussian beam theory, see [Gaussian Beams as Background Fields and Input Fields](#).

Define the Gaussian beam background field using the parameters below:

- Select a **Beam orientation**: **Along the x-axis** (the default), **Along the y-axis**, or for 3D components, **Along the z-axis**.
- Enter a **Beam radius**  $w_0$  (SI unit: m). The default is  $20\pi/\text{emw.k}_0$  m (10 vacuum wavelengths).
- Enter a **Focal plane along the axis**  $p_0$  (SI unit: m). The default is 0 m.
- Select an **Input quantity**: **Electric field amplitude** (the default) or **Power**.
- Enter the component expressions for the **Transverse background electric field amplitude**, **Gaussian beam**  $\mathbf{E}_{Tbg0}$  (SI unit: V/m) if the **Input quantity** is **Electric field amplitude**. Notice that this is the transverse Gaussian beam amplitude in the focal plane. When the **Gaussian beam type** is set to **Paraxial approximation** the background field is always orthogonal (transverse) to **Beam orientation**. However, when the **Gaussian beam type** is set to **Plane wave expansion**, the background field amplitude can also have a component in the propagation direction. Specify here only the field

amplitude components that are orthogonal to the propagation direction. COMSOL computes automatically the component in the propagation direction, if needed.

- If the **Input quantity** is set to **Power**, enter the **Input power** (SI unit: W in 2D axisymmetry and 3D and W/m in 2D) and the component expressions for the **Non-normalized transverse electric field amplitude, Gaussian beam**  $\mathbf{E}_{Tbg0}$  (SI unit: V/m).
- Enter a **Wave number**  $k$  (SI unit: rad/m). The default is  $\text{emw.k}_0$  rad/m. The wave number must evaluate to a value that is the same for all the domains the scattered field is applied to. Setting the **Wave number**  $k$  to a positive value, means that the wave is propagating in the positive  $x$ -,  $y$ -, or  $z$ -axis direction, whereas setting the **Wave number**  $k$  to a negative value means that the wave is propagating in the negative  $x$ -,  $y$ -, or  $z$ -axis direction.

#### *Linearly Polarized Plane Wave*

The initial background wave is predefined as  $\mathbf{E}_0 = \exp(-jk_x x)\mathbf{z}$ . This field is transformed by three successive rotations along the roll, pitch, and yaw angles, in that order. For a graphic representation of the initial background field and the definition of the three rotations compare with [Figure 4-1](#) below.

- Enter an **Electric field amplitude**  $E_0$  (SI unit: V/m). The default is 1 V/m.
- Enter a **Roll angle** (SI unit: rad), which is a right-handed rotation with respect to the  $+x$  direction. The default is 0 rad, corresponding to polarization along the  $+z$  direction.
- Enter a **Pitch angle** (SI unit: rad), which is a right-handed rotation with respect to the  $+y$  direction. The default is 0 rad, corresponding to the initial direction of propagation pointing in the  $+x$  direction.

- Enter a **Yaw angle** (SI unit: rad), which is a right-handed rotation with respect to the +z direction.
- Enter a **Wave number**  $k$  (SI unit: rad/m). The default is  $\text{emw.k}_0$  rad/m. The wave number must evaluate to a value that is the same for the domains the scattered field is applied to.

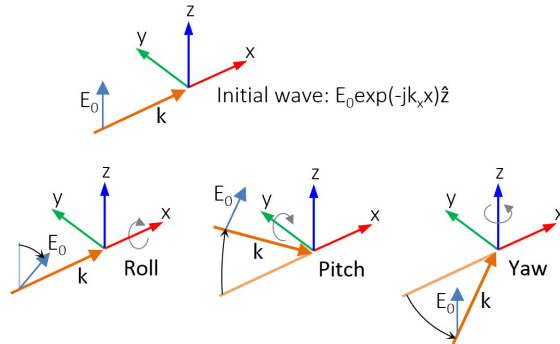

Figure 4-1: Schematic of the directions for the wave vector  $\mathbf{k}$ , the electric field  $\mathbf{E}_0$ , and the roll, pitch and yaw rotations. The top image represents an initial wave propagating in the x direction with a polarization along the z direction.

#### Circularly Polarized Plane Wave

The background wave is defined as

$$\mathbf{E}_b(r, \varphi, z) = \tilde{\mathbf{E}}_b(r, z) e^{-jm\varphi},$$

where

$$\tilde{\mathbf{E}}_b(r, z) = E_0(\hat{\mathbf{r}} - jm\hat{\boldsymbol{\phi}}) e^{-jkz},$$

$m$  is the azimuthal mode number (+1 or -1) varying depending on the **Circular polarization type** and **Direction of propagation** settings, and  $\hat{\mathbf{r}}$  and  $\hat{\boldsymbol{\phi}}$  are the unit vectors in the  $r$  and  $\varphi$  directions, respectively.

- Select the **Circular polarization type** — **Right handed** or **Left handed**.
- Select the **Direction of propagation** — **+z** or **-z**.
- Enter an **Electric field amplitude**  $E_0$  (SI unit: V/m). The default is 1 V/m.
- Enter an **Wave number**  $k$  (SI unit: rad/m). The default is  $\text{emw.k}_0$  rad/m.



### Linearly Polarized Plane Wave (2D Axisymmetry)

Linearly polarized plane wave can be written as the sum of an infinite number of azimuthal modes in cylindrical coordinates. Thus, the **Linearly polarized plane wave** option available for 2D axisymmetric components enables fast simulation of scattering problem for body-of-revolution geometries. For a graphic representation of the initial background field and the definition of the three rotations have a look at [Figure 4-2](#) below. To define a linearly polarized plane wave with arbitrary angle of incidence  $\theta$  and polarization  $\alpha$ :

- Enter an **Incident angle with respect to z-axis**  $\theta$  (SI unit: rad). The default is 0 rad.
- Enter a **Polarization angle**  $\alpha$  (SI unit: rad). The default is 0 rad.
- Enter a **Highest mode number**. The default is 10.
- Enter an **Electric field amplitude**  $E_0$  (SI unit: V/m). The default is 1 V/m.
- Enter a **Wave number**  $k$  (SI unit: rad/m). The default is `emw.k0` rad/m.
- Click the **Set up Sweep** button. This button creates a parameter `modeNum`, which will be used as the azimuthal mode number, and a parameter `highestMode`, which is the highest mode number used in the expansion. Then the auxiliary sweep in the first frequency domain study step under the first study will be enabled and a sweep over `modeNum` will be added.

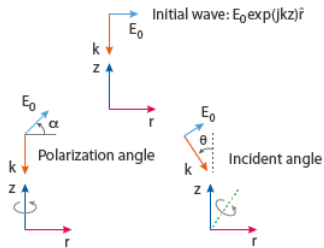

Figure 4-2: Schematic of the directions for the wave vector  $\mathbf{k}$ , the electric field  $\mathbf{E}_0$ , the polarization angle  $\alpha$ , and the incident angle  $\theta$ . The top image represents an initial wave propagating in the  $-z$  direction with a polarization along the  $r$  direction.



*Cloaking of a Cylindrical Scatterer with Graphene:* Application Library path `RF_Module/Scattering_and_RCS/cylinder_graphene_cloak` demonstrates how to set up the Linearly polarized plane wave background field.

### COMPONENTS

This section is available for 2D and 2D axisymmetric components.

Select the **Electric field components solved for** — **Three-component vector**, **Out-of-plane vector**, or **In-plane vector**. Select:

- **Three-component vector** (the default) to solve using a full three-component vector for the electric field  $\mathbf{E}$ .
- **Out-of-plane vector** to solve for the electric field vector component perpendicular to the modeling plane, assuming that there is no electric field in the plane.
- **In-plane vector** to solve for the electric field vector components in the modeling plane assuming that there is no electric field perpendicular to the plane.

#### **OUT-OF-PLANE WAVE NUMBER**

This section is available for 2D and 2D axisymmetric components, when solving for **Three-component vector** or **In-plane vector**.

For 2D components, assign a wave vector component to the **Out-of-plane wave number** field. For 2D axisymmetric components, assign an integer constant or an integer parameter expression to the **Azimuthal mode number** field.

#### **ANALYSIS METHODOLOGY**

From the **Methodology options** list, select one of three solver configurations: **Robust**, **Intermediate**, or **Fast** (the default).

The settings of each methodology option are found in **Solver Configurations** and the subsidiary nodes.

#### **PORT SWEEP SETTINGS**

Select the **Use manual port sweep** check box to enable the port sweep. When selected, this invokes a parametric sweep over the ports in addition to the frequency sweep already added. The generated lumped parameters are in the form of an S-parameter matrix.

For **Use manual port sweep** enter a **Sweep parameter name** to assign a specific name to the parameter that controls the port number solved for during the sweep. Before making the port sweep, the parameter must also have been added to the list of parameters in the **Parameters** section of the **Parameters** node under the **Global Definitions** node. This process can be automated by clicking the **Configure Sweep Settings** button. The **Configure Sweep Settings** button helps add a necessary port sweep

parameter and a **Parametric Sweep** study step in the last study node. If there is already a **Parametric Sweep** study step, the sweep settings are adjusted for the port sweep.



In the *COMSOL Multiphysics Reference Manual* see the [Frequency Domain Source Sweep](#) section for a discussion of how to use the Frequency Domain Source Sweep study type to perform efficient port sweeps.

Select **Export Touchstone file** and the S-parameters are subject to **Touchstone file export**. Click **Browse** to locate the file, or enter a file name and path. Select an **Parameter format (value pair)**: **Magnitude angle**, **Magnitude (dB) angle**, or **Real imaginary**.

Enter a **Reference impedance for Touchstone file export**  $Z_{\text{ref}}$  (SI unit:  $\Omega$ ) that is used only for the header in the exported Touchstone file. The default is 50  $\Omega$ .



It is also possible to export Touchstone files during postprocessing under the **Results** node. In the *COMSOL Multiphysics Reference Manual*, see the [Touchstone](#) section for more information on how to export Touchstone files as a postprocessing step.

#### PORT OPTIONS

To display this section, click the **Show More Options** button (  ) and select **Advanced Physics Options** in the **Show More Options** dialog box.

The electric field on port boundaries is expanded as

$$\mathbf{E}(\mathbf{r}) = \mathbf{E}_{\text{inc}}(\mathbf{r}) + \sum_i S_i \mathbf{E}_i(\mathbf{r}) \exp(-\alpha_i \mathbf{n} \cdot (\mathbf{r} - \mathbf{r}_0)),$$

where  $\mathbf{E}$ ,  $\mathbf{r}$ ,  $\mathbf{E}_{\text{inc}}$ ,  $S_i$ ,  $\mathbf{E}_i$ ,  $\alpha_i$ ,  $\mathbf{n}$ , and  $\mathbf{r}_0$  are, respectively, the electric field on the port boundary, the position vector, the incident electric field, the expansion coefficient (or S-parameter), the mode field, the propagation constant for the mode, the normal vector, and a position on the port boundary.

Select **Weak formulation** (the default value) from the **Port formulation** list. In this formulation, the expansion coefficients (or S-parameters) are calculated by adding a scalar dependent variable for each coefficient. The S-parameter and the tangential electric field on the port boundary are solved for by adding the following weak expression for each port

$$j\omega\mu_0(\mathbf{J}_{s,i} \cdot \text{test}(\mathbf{E}_T) - (\mathbf{n} \times \text{test}(\delta_{ij} - S_i)\mathbf{H}_i^* \cdot (\mathbf{E}_T - \mathbf{E}_{\text{bnd}}))),$$

where  $\mathbf{J}_{s,i}$  is the surface current density for the port

$$\mathbf{J}_{s,i} = -(\delta_{ij} - S_i)\mathbf{n} \times \mathbf{H}_i,$$

$\mathbf{E}_T$  is the tangential electric field (the dependent variable) on the port boundary,  $\delta_{ij}$  is the Kronecker delta

$$\delta_{ij} = \begin{cases} 1 & i = j \\ 0 & \text{else} \end{cases}.$$

Above,  $\mathbf{H}_i$  is the magnetic mode field for the port,  $\mathbf{E}_{\text{bnd}}$  is the expansion of the electric field on the port boundary in terms of the electric mode fields,  $\mathbf{E}_i$ ,

$$\mathbf{E}_{\text{bnd}} = \sum_i (\delta_{ij} + S_i)\mathbf{E}_i,$$

and  $\text{test}()$  is the test operator.



In the *COMSOL Multiphysics Reference Manual*, see the [Built-In Operators](#) section for more information about the test operator.

When **Constraint-based** is selected from the **Port formulation** list, the expansion coefficients (or S-parameters) are calculated by adding a scalar dependent variable for each coefficient and then adding a constraint to enforce the series expansion above.

#### DEPENDENT VARIABLES

The dependent variables (field variables) are for the **Electric field  $\mathbf{E}$**  and its components (in the **Electric field components** fields). The name can be changed but the names of fields and dependent variables must be unique within a model.



In 2D axisymmetry, for all studies except Mode Analysis and Boundary Mode Analysis, the [Covariant formulation](#) is used. Thereby, `Ephi` is not a dependent variable. To get the correct out-of-plane electric field component, the variable `emw.Ephi` should be used. Here, it is assumed that the dependent variable has been given the name `E` and that the tag for the physics interface is `emw`.

## DISCRETIZATION

Select the shape order for the **Electric field** dependent variable — **Linear**, **Linear type 2**, **Quadratic** (the default), **Quadratic type 2**, **Cubic**, or **Cubic type 2**. For more information about the **Discretization** section, see [Settings for the Discretization Sections](#) in the *COMSOL Multiphysics Reference Manual*.



- [Domain, Boundary, Edge, Point, and Pair Nodes for the Electromagnetic Waves, Frequency Domain Interface](#)
- [Theory for the Electromagnetic Waves Interfaces](#)



*H-Bend Waveguide 3D*: Application Library path **RF\_Module/Transmission\_Lines\_and\_Waveguides/h\_bend\_waveguide\_3d** demonstrates how to set up a port sweep.

---

### *Domain, Boundary, Edge, Point, and Pair Nodes for the Electromagnetic Waves, Frequency Domain Interface*

The [Electromagnetic Waves, Frequency Domain Interface](#) has these domain, boundary, edge, point, and pair nodes and subnodes. The nodes are listed in alphabetical order and are available from the **Physics** ribbon toolbar (Windows users), **Physics** context menu (Mac or Linux users), or by right-clicking to access the context menu (all users).



In general, to add a node, go to the **Physics** toolbar, no matter what operating system you are using. Subnodes are available by clicking the parent node and selecting it from the **Attributes** menu.

---

## DOMAIN

- Archie's Law
- Divergence Constraint
- External Current Density
- Specific Absorption Rate
- Far-Field Domain
- Initial Values
- Effective Medium
- Wave Equation, Electric
- Impedance Boundary Condition
- Perfect Electric Conductor

## BOUNDARY CONDITIONS

With no surface currents present, the boundary conditions

$$\mathbf{n}_2 \times (\mathbf{E}_1 - \mathbf{E}_2) = \mathbf{0}$$

$$\mathbf{n}_2 \times (\mathbf{H}_1 - \mathbf{H}_2) = \mathbf{0}$$

need to be fulfilled. Because  $\mathbf{E}$  is being solved for, the tangential component of the electric field is always continuous, and thus the first condition is automatically fulfilled. The second condition is equivalent to the natural boundary condition

$$-\mathbf{n} \times [(\mu_r^{-1} \nabla \times \mathbf{E})_1 - (\mu_r^{-1} \nabla \times \mathbf{E})_2] = \mathbf{n} \times j\omega\mu_0(\mathbf{H}_1 - \mathbf{H}_2) = \mathbf{0}$$

and is therefore also fulfilled. The following conditions are available (listed in alphabetical order):

- Diffraction Order
- Electric Field
- Far-Field Calculation
- Four-Port Network
- Impedance Boundary Condition
- Layered Impedance Boundary Condition
- Layered Transition Boundary Condition
- Lumped Element
- Lumped Port
- Magnetic Field
- Orthogonal Polarization
- Perfect Electric Conductor
- Perfect Magnetic Conductor
- Periodic Condition
- Port
- Scattering Boundary Condition
- Surface Current Density
- Surface Magnetic Current Density
- Surface Roughness
- Symmetry Plane
- Three-Port Network
- Transition Boundary Condition
- Two-Port Network

## EDGE, POINT, AND PAIR

- Circular Port Reference Axis
- Edge Current
- Electric Field
- Electric Point Dipole
- Electric Potential
- Ground
- Integration Line for Current
- Integration Line for Voltage
- Line Current (Out-of-Plane)
- Magnetic Current
- Magnetic Field
- Magnetic Point Dipole
- Perfect Electric Conductor
- Perfect Magnetic Conductor
- Periodic Port Reference Point
- Reference Point
- Surface Current Density
- Surface Magnetic Current Density
- Symmetry Axis Reference Point



For 2D axisymmetric components, COMSOL Multiphysics takes the axial symmetry boundaries (at  $r = 0$ ) into account and automatically adds an **Axial Symmetry** node to the component that is valid on the axial symmetry boundaries only.



In the *COMSOL Multiphysics Reference Manual* see [Table 2-4](#) for links to common sections and [Table 2-5](#) to common feature nodes. You can also search for information: press F1 to open the **Help** window or Ctrl+F1 to open the **Documentation** window.

### *Wave Equation, Electric*

**Wave Equation, Electric** is the main feature node for this physics interface. The governing equation can be written in the form

$$\nabla \times (\mu_{\text{r}}^{-1} \nabla \times \mathbf{E}) - k_0^2 \epsilon_{\text{rc}} \mathbf{E} = \mathbf{0}$$

for the time-harmonic and eigenfrequency problems. The wave number of free space  $k_0$  is defined as

$$k_0 = \omega \sqrt{\epsilon_0 \mu_0} = \frac{\omega}{c_0}$$



where  $c_0$  is the speed of light in vacuum.

In 2D the electric field varies with the out-of-plane wave number  $k_z$  as

$$\mathbf{E}(x, y, z) = \tilde{\mathbf{E}}(x, y) \exp(-ik_z z).$$

The wave equation is thereby rewritten as

$$(\nabla - ik_z \mathbf{z}) \times [\mu_r^{-1} (\nabla - ik_z \mathbf{z}) \times \tilde{\mathbf{E}}] - k_0^2 \epsilon_{rc} \tilde{\mathbf{E}} = \mathbf{0},$$

where  $\mathbf{z}$  is the unit vector in the out-of-plane  $z$  direction.

Notice that the ansatz above just explains how the wave equation is modified when the out-of-plane wave vector component  $k_z$  is not zero. As an example, for a plane wave with a nonzero out-of-plane wave vector component, the electric field is of course given by

$$\mathbf{E}(x, y, z) = \tilde{\mathbf{E}}(x, y) \exp(-ik_z z) = \mathbf{A} \exp(-i(k_x x + k_y y + k_z z)),$$

where  $\mathbf{A}$  is a constant amplitude and  $k_x$ ,  $k_y$ , and  $k_z$  are the wave vector components.

In 2D axisymmetry, the electric field varies with the azimuthal mode number  $m$  as

$$\mathbf{E}(r, \varphi, z) = \tilde{\mathbf{E}}(r, z) \exp(-im\varphi).$$

For this case, the wave equation is rewritten as

$$\left( \nabla - i \frac{m}{r} \boldsymbol{\varphi} \right) \times \left[ \mu_r^{-1} \left( \nabla - i \frac{m}{r} \boldsymbol{\varphi} \right) \times \tilde{\mathbf{E}} \right] - k_0^2 \epsilon_{rc} \tilde{\mathbf{E}} = \mathbf{0},$$

where  $\boldsymbol{\varphi}$  is the unit vector in the out-of-plane  $\varphi$  direction.



In 2D axisymmetry, for all studies except Mode Analysis and Boundary Mode Analysis, a covariant formulation for the out-of-plane electric field component is used. For more information, see [Covariant formulation](#).

When solving the equations as an eigenfrequency problem the eigenvalue is the complex eigenfrequency  $\lambda = -j\omega + \delta$ , where  $\delta$  is the damping of the solution. The Q factor is given from the eigenvalue by the formula

$$Q_{\text{fact}} = \frac{\omega}{2|\delta|}$$

Using the relation  $\epsilon_r = n^2$ , where  $n$  is the refractive index, the equation can alternatively be written

$$\nabla \times (\nabla \times \mathbf{E}) - k_0^2 n^2 \mathbf{E} = \mathbf{0}$$

When the equation is written using the refractive index, the assumption is that  $\mu_r = 1$  and  $\sigma = 0$  and only the constitutive relations for linear materials are available. When solving for the scattered field the same equations are used but  $\mathbf{E} = \mathbf{E}_{sc} + \mathbf{E}_i$  and  $\mathbf{E}_{sc}$  is the dependent variable.

The **Divergence Constraint** subnode is available from the context menu (right-click the parent node) or from the **Physics** toolbar, **Attributes** menu.

### ELECTRIC DISPLACEMENT FIELD

Select an **Electric displacement field model** — **Relative permittivity** (the default), **Refractive index**, **Loss tangent, loss angle**, **Loss tangent, dissipation factor**, **Dielectric loss**, **Drude-Lorentz dispersion model**, or **Debye dispersion model**.

---

Note that the following material models can automatically be synchronized to any of the other **Electric displacement field model** settings:

- **Relative permittivity**
- **Refractive index**
- **Loss tangent, loss angle**
- **Loss tangent, dissipation factor**
- **Dielectric loss**



As an example, the material can be specified to use a **Refractive index** material model. Then the real and imaginary parts of the refractive index can be synchronized to compute the complex relative permittivity, if the **Electric displacement field model** is set to **Relative permittivity**.

When synchronizing to the **Refractive index Electric displacement field model**, the source material model is assumed to be isotropic.

When synchronizing to the **Loss tangent, loss angle** and **Loss tangent, dissipation factor Electric displacement field models**, the loss angle  $\delta$  and the dissipation factor  $\tan\delta$ , respectively, must be converted to isotropic values.

---

### Relative Permittivity

When **Relative permittivity** is selected, the default **Relative permittivity**  $\epsilon_r$  takes values **From material**. Select **Effective medium** to add an [Effective Medium](#) subnode, or for **User defined** select **Isotropic**, **Diagonal**, **Symmetric**, or **Full** and enter values or expressions in the field or matrix.

### Refractive Index

When **Refractive index** is selected, the default **Refractive index**  $n$  and **Refractive index, imaginary part**  $k$  take the values **From material**. To specify the real and imaginary parts of the refractive index and assume a relative permeability of unity and zero conductivity, for one or both of the options, select **User defined** then choose **Isotropic**, **Diagonal**, **Symmetric**, or **Full**. Enter values or expressions in the field or matrix.



The diagonal components of the input refractive index matrix correspond to the semi-axes of the so called index ellipsoid. You can orient the index ellipsoid by first creating a suitably oriented coordinate system below the **Definitions** node for the model component. Then select the created coordinate system in the **Coordinate system** setting in the **Coordinate System Selection** section in the settings for the **Wave Equation, Electric** feature.



Beware of the time-harmonic sign convention requiring a lossy material having a negative imaginary part of the refractive index (see [Introducing Losses in the Frequency Domain](#)).

### Loss Tangent, Loss Angle

When **Loss tangent, loss angle** is selected, the default **Relative permittivity (real part)**  $\epsilon'$  and **Loss tangent, loss angle**  $\delta$  take values **From material**. For **User defined** select **Isotropic**, **Diagonal**, **Symmetric**, or **Full** and enter values or expressions in the field or matrix. Then if **User defined** is selected for **Loss tangent, loss angle**  $\delta$ , enter a value to specify a loss angle for dielectric losses. This assumes a zero conductivity.

### Loss Tangent, Dissipation Factor

When **Loss tangent, dissipation factor** is selected, the default **Relative permittivity (real part)**  $\epsilon'$  and **Loss tangent, dissipation factor**  $\tan\delta$  take values **From material**. For **User defined** select **Isotropic**, **Diagonal**, **Symmetric**, or **Full** and enter values or expressions in the field or matrix. Then if **User defined** is selected for **Loss tangent, dissipation factor**

$\tan\delta$ , enter a value to specify a dissipation for dielectric losses. This assumes a zero conductivity.

#### Dielectric Loss

When **Dielectric loss** is selected, the default **Relative permittivity**  $\epsilon'$  and **Relative permittivity (imaginary part)**  $\epsilon''$  take values **From material**. For **User defined** select **Isotropic, Diagonal, Symmetric**, or **Full** and enter values or expressions in the field or matrix.



Beware of the time-harmonic sign convention requiring a lossy material having a negative imaginary part of the relative permittivity (see [Introducing Losses in the Frequency Domain](#)).

#### Drude-Lorentz Dispersion Model

The **Drude-Lorentz dispersion model** is defined by the equation

$$\epsilon_r(\omega) = \epsilon_\infty + \sum_{j=1}^M \frac{f_j \omega_P^2}{\omega_{0j}^2 - \omega^2 + i\Gamma_j \omega}$$

where  $\epsilon_\infty$  is the high-frequency contribution to the relative permittivity,  $\omega_P$  is the plasma frequency,  $f_j$  is the oscillator strength,  $\omega_{0j}$  is the resonance frequency, and  $\Gamma_j$  is the damping coefficient.

For the **Drude-Lorentz dispersion model** select **User defined** (default) or **From material** for **Relative permittivity, high frequency**  $\epsilon_\infty$  (dimensionless). For **User defined** select **Isotropic, Diagonal, Symmetric**, or **Full** and enter a value or expression in the field or matrix.

Enter a **Plasma frequency**  $\omega_\infty$  (SI unit: rad/s). The default is 0 rad/s.

In the table, enter values or expressions in the columns for the **Oscillator strength**, **Resonance frequency (rad/s)**, and **Damping in time (rad/s)**.

#### Debye Dispersion Model

The **Debye dispersion model** is given by

$$\epsilon(\omega) = \epsilon_\infty + \sum_k \frac{\Delta\epsilon_k}{1 + i\omega\tau_k}$$

where  $\epsilon_\infty$  is the high-frequency contribution to the relative permittivity,  $\Delta\epsilon_k$  is the contribution to the relative permittivity, and  $\tau_k$  is the relaxation time.

For the **Debye dispersion model** select **User defined** (default) or **From material** for **Relative permittivity, high frequency**  $\epsilon_\infty$  (dimensionless). For **User defined** select **Isotropic**, **Diagonal**, **Symmetric**, or **Full** and enter a value or expression in the field or matrix.

In the table, enter values or expressions in the columns for the **Relative permittivity contribution** and **Relaxation time (s)**.

## MAGNETIC FIELD

Select the **Constitutive relation** — **Relative permeability** (the default) or **Magnetic losses**.



For magnetic losses, beware of the time-harmonic sign convention requiring a lossy material having a negative imaginary part of the relative permeability (see [Introducing Losses in the Frequency Domain](#)).

- For **Relative permeability** the relative permeability  $\mu_r$  uses values **From material**. For **User defined** select **Isotropic**, **Diagonal**, **Symmetric**, or **Full** based on the characteristics of the magnetic field, and then enter values or expressions in the field or matrix. If **Effective medium** is selected, the [Effective Medium](#) subnode is available from the context menu (right-click the parent node) or from the **Physics** toolbar, **Attributes** menu.
- For **Magnetic losses** the default values for **Relative permeability (real part)**  $\mu'$  and **Relative permeability (imaginary part)**  $\mu''$  are taken **From material**. For **User defined** enter different values.

## CONDUCTION CURRENT

By default, the **Electrical conductivity**  $\sigma$  (SI unit: S/m) uses values **From material**.

- For **User defined** select **Isotropic**, **Diagonal**, **Symmetric**, or **Full** based on the characteristics of the current and enter values or expressions in the field or matrix.
- For **Linearized resistivity** the default values for the **Reference temperature**  $T_{\text{ref}}$  (SI unit: K), **Resistivity temperature coefficient**  $\alpha$  (SI unit: 1/K), and **Reference resistivity**  $\rho_0$  (SI unit:  $\Omega\cdot\text{m}$ ) are taken **From material**. For **User defined** enter other values or expressions for any of these variables.
- When **Effective medium** is selected, the [Effective Medium](#) subnode is available from the context menu (right-click the parent node) or from the **Physics** toolbar, **Attributes** menu.
- When **Archie's law** is selected, the [Archie's Law](#) subnode is available from the context menu (right-click the parent node) or from the **Physics** toolbar, **Attributes** menu.

## *Divergence Constraint*

---

The **Divergence Constraint** subnode is available from the context menu (right-click the [Wave Equation, Electric](#) parent node) or from the **Physics** toolbar, **Attributes** menu. It is used for numerical stabilization when the frequency is low enough for the total electric current density related term in the wave equation to become numerically insignificant. For [The Electromagnetic Waves, Frequency Domain Interface](#) and [Heat Transfer Interfaces](#) the divergence condition is given by

$$\nabla \cdot \mathbf{J} = 0$$

and for [The Electromagnetic Waves, Transient Interface](#) it is

$$\nabla \cdot (\sigma \mathbf{A}) = 0$$

### **DIVERGENCE CONSTRAINT**

Enter a value or expression for the **Divergence condition variable scaling**  $\psi_0$ .

For the [Electromagnetic Waves, Frequency Domain](#) and [Microwave Heating](#) interfaces, the SI unit is  $\text{kg}/(\text{m}\cdot\text{s}^3\cdot\text{A})$ . The default is  $1 \text{ kg}/(\text{m}\cdot\text{s}^3\cdot\text{A})$ .

For the [Electromagnetic Waves, Transient interface](#) (and the [Microwave Plasma interface](#) available with the [Plasma Module](#)) the SI unit is  $\text{A}/\text{m}$  and the default is  $1 \text{ A}/\text{m}$ .

## *Initial Values*

---

The **Initial Values** node adds an initial value for the electric field that can serve as an initial guess for a nonlinear solver. Add additional **Initial Values** nodes from the **Physics** toolbar.

### **INITIAL VALUES**

Enter values or expressions for the initial values of the components of the **Electric field**  $\mathbf{E}$  (SI unit:  $\text{V}/\text{m}$ ). The default values are  $0 \text{ V}/\text{m}$ .

## *External Current Density*

---

The **External Current Density** node adds an externally generated current density  $\mathbf{J}_e$ , which appears in Ohm's law

$$\mathbf{J} = \sigma \mathbf{E} + \mathbf{J}_e$$

and in the equation that the physics interface defines.

#### EXTERNAL CURRENT DENSITY

Based on space dimension, enter the components (**x**, **y**, and **z** for 3D components for example) of the **External current density**  $\mathbf{J}_e$  (SI unit: A/m<sup>2</sup>).

### *Far-Field Domain*

---

To set up a far-field calculation, add a **Far-Field Domain** node and specify the far-field domains in its Settings window. Use [Far-Field Calculation](#) subnodes (one is added by default) to specify all other settings needed to define the far-field calculation. If a **Perfectly Matched Layer** (PML) node has been added before adding the **Far-Field Domain**, all of the domains in the Electromagnetic Waves, Frequency Domain interface adjacent to the PML are automatically selected by default. If there is no PML, all of the domains are selected. The selection can be modified. In that case, select only a homogeneous domain or domain group that is outside of all radiating and scattering objects and which has the material settings of the far-field medium.



[Far-Field Support in the Electromagnetic Waves, Frequency Domain Interface](#)

---



*Radars Cross Section:* Application Library path **RF\_Module/Scattering\_and\_RCS/radar\_cross\_section**

*Biconical Antenna:* Application Library path **RF\_Module/Antennas/biconical\_antenna**

---

### *Far-Field Calculation*

---

A **Far-Field Calculation** subnode is added by default to the [Far-Field Domain](#) node and is used to select boundaries corresponding to a single closed surface surrounding all radiating and scattering objects. By default, all exterior boundaries of the [Far-Field Domain](#) are selected. If a **Perfectly Matched Layer** (PML) node has been added before adding the **Far-Field Domain**, all exterior boundaries of the [Far-Field Domain](#) adjacent to the PML are selected. The selection can be edited, but only boundaries adjacent and exterior to the [Far-Field Domain](#) are selectable. Symmetry reduction of the geometry makes it relevant to select boundaries defining a nonclosed surface. Also use this feature to indicate symmetry planes and symmetry cuts applied to the geometry, and

whether the selected boundaries are defining the inside or outside of the far field domain; that is, to say whether they are facing away from infinity or toward infinity.

#### **FAR-FIELD CALCULATION**

Enter a **Far-field variable name**. The default is  $E_{far}$ .

Select the **Symmetry settings** — **From symmetry plane(s)** or **User defined**.

##### *From symmetry plane(s)*

When a model is reduced with **Symmetry Plane** features, use **From symmetry plane(s)** option to adjust far-field calculation automatically. The symmetry plane features have to coincide with one of the Cartesian coordinate planes.

##### *User defined*

Select as needed the **Symmetry in the  $x=0$  plane**, **Symmetry in the  $y=0$  plane**, or **Symmetry in the  $z=0$  plane** check boxes to use it your model when calculating the far-field variable. The symmetry planes have to coincide with one of the Cartesian coordinate planes.

When a check box is selected, also choose the type of symmetry to use from the **Symmetry type** list that appears — **Symmetry in E (PMC)** or **Symmetry in H (PEC)**. The selection should match the boundary condition used for the symmetry boundary. Using these settings, include the parts of the geometry that are not in the model for symmetry reasons in the far-field analysis.

From the **Boundary relative to domain** list, select **Inside** or **Outside** (the default) to define if the selected boundaries are defining the inside or outside of the far-field domain (that is, whether facing away from infinity or toward infinity).

#### **ADVANCED SETTINGS**

To display this section, click the **Show More Options** button (  ) and select **Advanced Physics Options** in the **Show More Options** dialog box.

Enter an **Average operator integration order**. The default is 2. The average operator is used when calculating the maximum directivity or total radiated power.

Select the **Maximum operator point type** — **Node point**, **Integration points**, or **Lagrange points**.

When selecting the **Integration points**, enter a **Maximum operator integration order**. The default is 2. When selecting the **Lagrange points**, enter a **Maximum operator Lagrange order**. The default is 2. The maximum operator is used when calculating the maximum directivity, maximum gain, or maximum realized gain.



A higher operator order value improves accuracy with a longer time of computation.



If perfectly matched layers are added to the model after the [Far-Field Domain](#) is configured, then it is necessary to press the **Reset Far-Field Boundaries** button to reassign all exterior boundaries (and reset **Boundary relative to domain** to **Outside**).



*Dielectric Resonator Antenna*: Application Library path **RF\_Module/Antennas/dielectric\_resonator\_antenna**

### *Specific Absorption Rate*

To calculate specific absorption rate (SAR), add a **Specific Absorption Rate** node and specify the material density in its Settings window. The specific absorption rate is calculated as

$$SAR = \frac{\sigma |\mathbf{E}|^2}{2\rho}.$$

#### *Density*

When using **From material**,  $\rho$  is defined from the material node where the domain selection is common to this feature. Select **User defined** to enter the value directly.



*Specific Absorption Rate (SAR) in the Human Brain*: Application Library path **RF\_Module/Microwave\_Heating/sar\_in\_human\_head**

### *Perfect Electric Conductor*

The **Perfect Electric Conductor** boundary condition

$$\mathbf{n} \times \mathbf{E} = \mathbf{0}$$

is a special case of the electric field boundary condition that sets the tangential component of the electric field to zero. It is used for modeling of a lossless metallic surface (for example, a ground plane) or as a symmetry type boundary condition. It imposes symmetry for magnetic fields and “magnetic currents” and antisymmetry for electric fields and electric currents. It supports induced electric surface currents and thus any prescribed or induced electric currents (volume, surface, or edge currents)

flowing into a *perfect electric conductor* boundary is automatically balanced by induced surface currents.

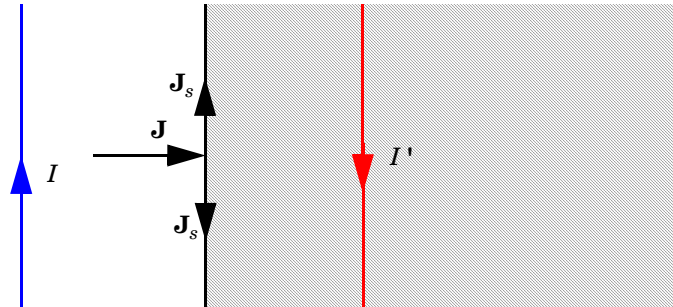

*Figure 4-3: The perfect electric conductor boundary condition is used on exterior and interior boundaries representing the surface of a lossless metallic conductor or (on exterior boundaries) representing a symmetry cut. The shaded (metallic) region is not part of the model but still carries effective mirror images of the sources. Note also that any current flowing into the boundary is perfectly balanced by induced surface currents. The tangential electric field vanishes at the boundary.*

For a better option to work with symmetries, use [Symmetry Plane](#).

#### CONSTRAINT SETTINGS

To display this section, click the **Show More Options** button (  ) and select **Advanced Physics Options** in the **Show More Options** dialog box. For information about the **Constraint Settings** section, see [Constraint Settings](#) in the *COMSOL Multiphysics Reference Manual*.



Perfect electric conductors can be applied to domains that deselect the physics within those domains and instead apply the boundary condition to exterior boundaries of the domains. Using the domain feature may reduce the number of steps defining selections.



*RF Coil*: Application Library path **RF\_Module/Passive\_Devices/rf\_coil**

#### *Perfect Magnetic Conductor*

The **Perfect Magnetic Conductor** boundary condition

$$\mathbf{n} \times \mathbf{H} = \mathbf{0}$$

is a special case of the surface current boundary condition that sets the tangential component of the magnetic field and thus also the surface current density to zero. On external boundaries, this can be interpreted as a “high surface impedance” boundary condition or used as a symmetry type boundary condition. It imposes symmetry for electric fields and electric currents. Electric currents (volume, surface, or edge currents) are not allowed to flow into a *perfect magnetic conductor* boundary as that would violate current conservation. On interior boundaries, the perfect magnetic conductor boundary condition literally sets the tangential magnetic field to zero, which in addition to setting the surface current density to zero also makes the tangential electric field discontinuous.

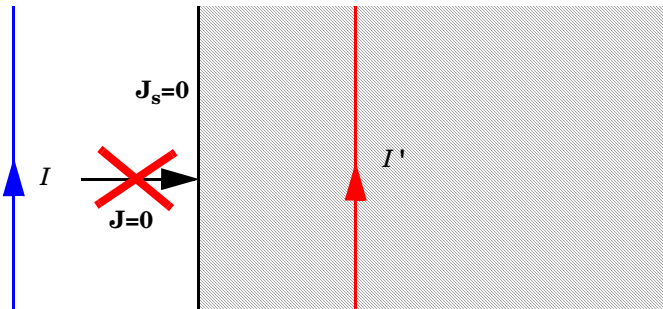

*Figure 4-4: The perfect magnetic conductor boundary condition is used on exterior boundaries representing the surface of a high impedance region or a symmetry cut. The shaded (high impedance) region is not part of the model but nevertheless carries effective mirror images of the sources. Note also that any electric current flowing into the boundary is forbidden as it cannot be balanced by induced electric surface currents. The tangential magnetic field vanishes at the boundary. On interior boundaries, the perfect magnetic conductor boundary condition literally sets the tangential magnetic field to zero which in addition to setting the surface current density to zero also makes the tangential electric field (and in dynamics the tangential electric field) discontinuous.*

For a better option to work with symmetries, use [Symmetry Plane](#).



*Magnetic Frill*: Application Library path **RF\_Module/Antennas/**  
**magnetic\_frill**

### *Port*

Use the **Port** node where electromagnetic energy enters or exits the model. A port can launch and absorb specific modes. Use the boundary condition to specify wave type ports. Ports support S-parameter calculations but can be used just for exciting the model. This node is not available with the Electromagnetic Waves, Transient interface.

A port assumes that the cross section's geometry and material is constant in the normal direction. Furthermore, the port boundary is assumed to be flat, resulting in a constant normal across the boundary.

In 3D, the following subnodes are available from the context menu, by right-clicking the **Port** node, or from the **Physics** toolbar, **Attributes** menu:

- **Circular Port Reference Axis** to determine a reference direction for the modes. This subnode is selected from the **Points** submenu when **Circular** is selected as the type of port.
- **Periodic Port Reference Point** to uniquely determine reciprocal lattice vectors. This subnode is selected from the **Points** submenu when **Periodic** is selected as the type of port.

When **Transverse electromagnetic (TEM)** is selected as the type of port, the following subnodes are available from the context menu, by right-clicking the **Port** node, or from the **Physics** toolbar, **Attributes** menu:

- **Ground** to define zero potential boundaries for the port mode field calculation in **TEM Boundary Mode Analysis**.
- **Electric Potential** to define positive or negative 1 V potential boundaries for the port mode field calculation in **TEM Boundary Mode Analysis**.

#### **PORT PROPERTIES**

Enter a unique **Port name**. Only nonnegative integer numbers can be used as **Port name** as it is used to define the elements of the S-parameter matrix and numeric port names are also required for port sweeps and Touchstone file export.

Select the **Type of Port** — **User defined**, **Numeric**, **Transverse electromagnetic (TEM)**, **Rectangular**, **Coaxial**, **Circular**, or **Periodic**.

**Periodic** ports are available in 3D and 2D. **Circular** and **Coaxial** ports are available in 3D and 2D axisymmetry.

**Numeric** ports require a **Boundary Mode Analysis** study type. It should appear before the frequency domain study node in the study branch of the model tree. If more than one numeric port is needed, use one Boundary Mode Analysis node per port and assign each to the appropriate port. Then, it is best to add all the studies; Boundary Mode Analysis 1, Boundary Mode Analysis 2, ..., Frequency Domain 1, manually. **Numeric**

ports are by default computed for the deformed mesh whereas other types of ports compute the mode shape using geometry information.

---

The Boundary Mode Analysis study step stores the frequency  $f_{\text{ref}}$  and propagation constant  $\beta_{\text{ref}}$  for which it was run. For a TE, TM, or TEM mode, the propagation constant  $\beta$  for an arbitrary frequency  $f$  is given by

$$\beta^2 = \beta_{\text{ref}}^2 + k^2(1 - (f_{\text{ref}}/f)^2).$$



In addition, for TE, TM, and TEM modes, the mode field shape is independent of the frequency. Thus, when making a frequency sweep including only TE, TM, and TEM modes, the Boundary Mode Analysis study steps can be done for just one frequency, with the propagation constants obtained from the expression above for the other frequencies. For waveguides consisting of multiple dielectric materials, like optical fibers, where there are no TE, TM, or, TEM modes, the Boundary Mode Analysis steps must be recomputed for each frequency.



It is only possible to excite one port at a time if the purpose is to compute S-parameters. In other cases (for example, when studying microwave heating) more than one inport might be wanted, but the S-parameter variables cannot be correctly computed, so when several ports are excited, the S-parameter output is turned off.

---

**Transverse electromagnetic (TEM)** ports require a **TEM Boundary Mode Analysis** study type. It should appear before the frequency domain study node in the study branch of the model tree. Add Ground and Electric Potential subnodes to compute the port mode field and impedance. These subnodes are available from the context menu (right-click the Port parent node) or from the **Physics** toolbar, **Attributes** menu. Enter a **Characteristic impedance**  $Z_{\text{ref}}$  (SI unit:  $\Omega$ ). The default is 50  $\Omega$ . The characteristic impedance of a port is calculated using the square root of the ratio of the inductance and capacitance. The electric mode field on a port boundary is scaled by the ratio between the computed mode characteristic impedance and  $Z_{\text{ref}}$ .

#### *Wave Excitation at this Port*

To set whether it is an inport or a listener port, select **On** or **Off** from the **Wave excitation at this port** list. If **On** is selected, enter a **Port input power**  $P_{\text{in}}$  (SI unit: W in 3D and 2D axisymmetry and W/m in 2D) or a **Deposited power**  $P_{\text{dep}}$  (SI unit: W in 3D and

2D axisymmetry and W/m in 2D) if the **Enable active port feedback** check box is marked. When a **Deposited power** is specified, the input power is adjusted so that the power that is not reflected equals the specified **Deposited power**. If **Enable active port feedback** is marked this must be the only inport.



The [Port Sweep Settings](#) section in the Electromagnetic Waves, Frequency Domain interface cycles through the ports, computes the entire S-matrix and exports it to a Touchstone file. When using port sweeps, the local setting for **Wave excitation at this port** is overridden by the solver so only one port at a time is excited.

#### *Activate Slit Condition*

Select the **Activate slit condition on interior port** check box to use the **Port** boundary condition on interior boundaries.

Then select a **Slit type** — **PEC-backed** (the default) or **Domain-backed**. The **PEC-backed** type makes the port on interior boundaries perform as it does on exterior boundaries. The **Domain-backed** type can be combined with perfectly matched layers to absorb the excited mode from a source port and other higher order modes.

Click **Toggle Power Flow Direction** button to define the power flow for the port. For an excited port, the power flow should point in to the excited domain and for a listener port the power flow should point out from the excited domain. The power flow direction is visualized with a red arrow on the port boundary in the Graphics window.



When the **Slit type** is set to **Domain-backed**, there must be no waves reflected from the domain backing the port. Thus, the backing domain must have homogeneous material and geometric properties and it should be truncated by a PML domain or a nonreflecting boundary condition.



When an active slit port is adjacent to a periodic condition, the periodic condition needs to be split at the active port, as the field is discontinuous at the point (in 2D) or edge (in 3D) where the slit port and the periodic condition meet.

#### *Analyze as a TEM Field*

This check box is available for 3D components and when the **Type of port** is **Numeric**.

When analyzing an arbitrary shape of a port, if the port boundary consists of at least two separate conducting parts, the port can support a (quasi-) TEM mode. In this case,

it is possible to calculate the port mode characteristic impedance from the results of a **Boundary Mode Analysis** and include the impedance mismatch compared to the user-specified reference impedance in the simulation by selecting the **Analyze as a TEM field** check box. The **Analyze as a TEM field** requires an [Integration Line for Voltage](#) subfeature to calculate the port mode impedance. The [Integration Line for Current](#) subfeature is optional. The impedance is calculated using either the ratio of the voltage and current when both [Integration Line for Voltage](#) and [Integration Line for Current](#) are defined, or deduced from the voltage and power when only the [Integration Line for Voltage](#) is defined. These subfeatures are available from the context menu (right-click the Port parent node) or from the **Physics** toolbar, **Attributes** menu.

Enter a reference **Characteristic impedance**  $Z_{\text{ref}}$  (SI unit:  $\Omega$ ). The default is 50  $\Omega$ . The mode field on a port boundary is scaled by the ratio between the computed characteristic impedance and user-specified  $Z_{\text{ref}}$ .



*Notch Filter Using a Split Ring Resonator*: Application Library path  
**RF\_Module/Filters/notch\_filter\_srr**

---

#### PORT MODE SETTINGS

The input is based on the **Type of Port** selected above — [User Defined](#), [Rectangular](#), [Circular](#), or [Periodic](#). No entry is required if **Numeric** or **Coaxial** are selected.

Set the **Mode phase**  $\theta_{\text{in}}$  (SI unit: rad) for the port mode field. The default is 0 radians. For instance, if the inspected port mode field is polarized in the opposite direction compared to the expected direction, a **Mode phase** of  $\pi$  (enter  $\text{pi}$  in the field) can be used for polarizing the mode field in the expected direction. Notice that a change of the **Mode phase**, either on the exciting or the listener port, changes also the S-parameter coupling the exciting and the listener port. However, a change of the **Mode phase** on the exciting port does not modify the reflection coefficient (normally denoted S11) associated with the exciting port.

### User Defined

For **User defined** specify the eigenmode of the outgoing wave at the port. Even if **Wave excitation at this port** is set to **On**, the mode field should represent the outgoing wave. The mode field can be entered with an arbitrary amplitude and is normalized internally.

- Enter the components of the **Electric mode field  $\mathbf{E}_0$**  (SI unit: V/m) or the **Magnetic mode field  $\mathbf{H}_0$**  (SI unit: A/m). The entered expressions must be differentiable.
- Enter the **Propagation constant  $\beta$**  (SI unit: rad/m). This is frequency dependent for all but TEM modes and a correct frequency-dependent expression must be used.



Notice that for models saved before COMSOL 6.0, the mode field represented the incoming (exciting) wave. When opening such a model, the mode field is now automatically migrated to represent the outgoing wave.

---



Notice that expressions including coupling operators are not differentiable and cannot be used as mode fields.

---

### Rectangular

The following figure shows an example of a boundary selection for a **Rectangular** waveguide port in a 3D model. The mode field is assigned to this selection.

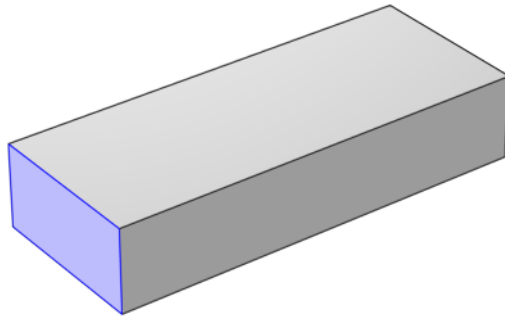

For **Rectangular** specify a unique rectangular mode.

For 3D components, select a **Mode type** — **Transverse electric (TE)** or **Transverse magnetic (TM)**. Enter the **Mode number**, for example, 10 for a  $TE_{10}$  mode, or 11 for a  $TM_{11}$  mode. When the port boundaries are parallel to one of the Cartesian coordinate



planes, click the **Plot Analytical Port Mode Field** button to inspect the mode field instantly before running a simulation.

For 2D components, to excite the fundamental mode, select the mode type **Transverse electromagnetic (TEM)**, since the rectangular port represents a parallel-plate waveguide port that can support a TEM mode. Only TE modes are possible when solving for the out-of-plane vector component, and only TM and TEM modes are possible when solving for the in-plane vector components. There is only a single mode number, which is selected from a list.

#### *Coaxial*

The following figure shows an example of a boundary selection for a **Coaxial** waveguide port in a 3D model. The mode field is assigned to this selection.

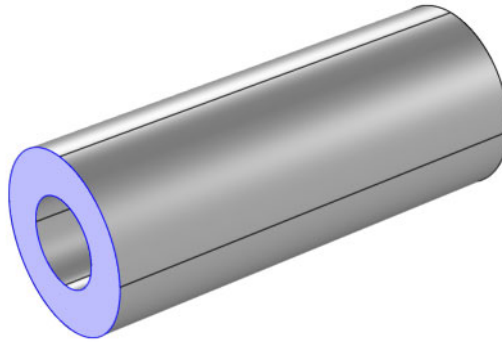

**Coaxial** only supports **Transverse electromagnetic (TEM)** mode type. When the port boundaries are parallel to one of the Cartesian coordinate planes, click the **Plot Analytical Port Mode Field** button to inspect the mode field instantly before running a simulation.

In 2D axisymmetry, **Coaxial** does not support nonzero azimuthal mode number. The **Azimuthal mode number** in the **Physics interface** should be defined as zero.

### *Circular*

The following figure shows an example of a boundary selection for a **Circular** waveguide port in a 3D model. The mode field is assigned to this selection.

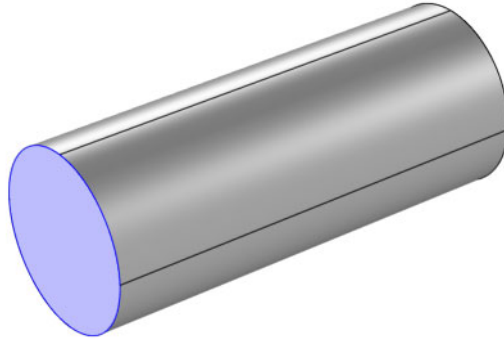

For **Circular** specify a unique circular mode.

- Select a **Mode type** — **Transverse electric (TE)** or **Transverse magnetic (TM)**.
- Select the **Mode number** from the list.

For 3D components, enter the **Mode number**, for example, 11 for a  $TE_{11}$  mode, or 01 for a  $TM_{01}$  mode. When **Circular** is selected as the type of port in 3D, the **Circular Port Reference Axis** subnode is available from the context menu (right-click the parent node) or from the **Physics** toolbar, **Attributes** menu. It defines the orientation of fields on a port boundary. When the port boundaries are parallel to one of the Cartesian coordinate planes, click the **Plot Analytical Port Mode Field** button to inspect the mode field instantly before running a simulation.

For 2D axisymmetry components, select whether the **Azimuthal mode number** is defined in the **Physics interface** or if it is **User defined**. For **User defined** define an integer constant or an integer parameter expression for the **Azimuthal mode number**. Note that the absolute value of the **Azimuthal mode number** must be less than 11.

### *Periodic*

For **Periodic**, specify parameters for the mode field. When **Periodic** is selected, the **Diffraction Order** port subnode is available from the context menu (right-click the parent node) or from the **Physics** toolbar, **Attributes** menu.

Select an **Input quantity** — **Electric field** or **Magnetic field** — and define the mode field amplitude for the outgoing wave at the port. Even if **Wave excitation at this port** is set

to **On**, the mode field amplitude should represent the outgoing wave that corresponds to the actual incoming wave.

- For 2D components and if the **Input quantity** is set to **Electric field**, define the **Electric mode field amplitude**. For example, for a TE wave set the  $x, y,$  and  $z$  components to 0, 0, 1. Similarly, if the **Input quantity** is set to **Magnetic field**, define the **Magnetic mode field amplitude**. For a TM wave set the  $x, y,$  and  $z$  components to 0, 0, and 1.
- Define the **Angle of incidence**, if **Wave excitation at this port** is **On**.

For 3D components, if **Wave excitation at this port** is **On**, define the **Elevation angle of incidence** and **Azimuth angle of incidence**. The **Elevation angle of incidence**  $\alpha_1$  and **Azimuth angle of incidence**  $\alpha_2$  are used in the relations

$$\mathbf{k} = \mathbf{k}_{\text{parallel}} + \mathbf{k}_{\text{perpendicular}}$$

$$\mathbf{k}_{\text{parallel}} = \mathbf{k}_F = |k| \sin \alpha_1 (\hat{\mathbf{a}}_1 \cos \alpha_2 + \mathbf{n} \times \hat{\mathbf{a}}_1 \sin \alpha_2)$$

where  $\mathbf{k}$  is the wave vector,  $\mathbf{k}_{\text{parallel}}$  is the projection of  $\mathbf{k}$  onto the port,  $\mathbf{k}_F$  is the  $k$ -vector for Floquet periodicity,  $\mathbf{n}$  is the outward unit normal vector to the boundary, and  $\hat{\mathbf{a}}_1$  is one of the normalized primitive unit cell vectors from the periodic structure defined from [Periodic Port Reference Point](#).

The **Elevation angle of incidence**  $\alpha_1$  is the angle between  $\mathbf{n}$  and  $\mathbf{k}$ .

The **Azimuth angle of incidence** is the counterclockwise rotating angle from the primitive vector  $\mathbf{a}_1$  around the axis built with [Periodic Port Reference Point](#) and  $\mathbf{n}$ .

For periodic ports with hexagonal port boundaries, the definition of the vector  $\mathbf{a}_1$  is slightly different from the default definition. In this case, the unit cell is actually a rhomboid, with primitive vectors pointing in other directions than the side vectors of the hexagon. Thus, for a hexagonal periodic port, the vector  $\mathbf{a}_1$  is defined along one of the sides of the hexagon, and it is not one of the primitive vectors of the hexagonal point lattice. The **Azimuth angle of incidence**  $\alpha_2$  is still measured from the vector  $\mathbf{a}_1$ , even though this vector now refers to a side vector of the hexagonal port boundary and not a primitive vector.



*Hexagonal Grating:* Application Library path **RF\_Module/Tutorials/hexagonal\_grating**

---

For 2D components define the **Angle of incidence**. The **Angle of incidence**  $\alpha$  is defined by the relation

$$\mathbf{k} \times \mathbf{n} = k \sin \alpha \mathbf{z}$$

where  $\mathbf{k}$  is the projection of the wave vector in the  $xy$ -plane,  $\mathbf{n}$  is the normalized normal vector to the boundary,  $k$  is the magnitude of the projected wave vector in the  $xy$ -plane, and  $\mathbf{z}$  is the unit vector in the  $z$  direction.



Notice that for models saved before COMSOL 6.0, the mode field represented the incoming (exciting) wave. When opening such a model, the mode field is now automatically migrated to represent the outgoing wave.



Notice that the mode field defined for the Periodic port assumes homogeneous isotropic material properties in the domain adjacent to the selected port boundary.

For more details about the periodic port mode fields, see [Periodic Port Mode Fields](#)



The propagation directions for listener **Periodic** ports are deduced from the angle setting(s) for the source **Periodic** port and the refractive indices defined for the source and the listener ports. Thus, adding source **Periodic** ports with different propagation angles will give ambiguous propagation directions for the listener **Periodic** ports.

Default Polarization plots are automatically generated for **Periodic** ports in 3D and in 2D, if the **Electric field components solved for** setting in the **Components** section for the physics interface is set to **Three-component vector**. The Polarization plot includes polarization ellipses for each diffraction order. The polarization ellipse line graphs are generated by plotting the in-plane Jones vector element versus the out-of-plane Jones vector element.



For more information about Jones Vectors and Polarization plots, see [Jones Vectors and Polarization Plots](#).

#### **AUTOMATIC DIFFRACTION ORDER CALCULATION**

This section is only available for **Periodic** ports to provide parameter settings that are used when automatically adding [Diffraction Order](#) subnodes to **Periodic** ports.

- Select the **Include in automatic diffraction order calculation** check box to add **Diffraction Order** subnodes to the selected **Periodic** port, when the **Add Diffraction Orders** button is clicked from the exciting **Periodic** port.
- Define the **Refractive index, real part** at the boundary.
- Define the **Maximum frequency** — **From study** (the default) or **User defined**. When **From study** is selected, the **Maximum frequency** is taken from the study step associated with the physics interface. For **User defined**, enter the maximum frequency  $f_{\max}$  (SI unit: Hz). The default value is 0 Hz. If a single frequency is used, insert the frequency, or if a frequency sweep is performed, insert the maximum frequency of the sweep. This parameter is only available when **Wave excitation at this port** is **On**.

When all parameters are defined, click the **Add Diffraction Orders** button from the exciting **Periodic** port to automatically create **Diffraction Order** ports as subnodes to all **Periodic** ports having the **Include in automatic diffraction order calculation** check box selected.

#### CUTOFF FREQUENCY CALCULATOR

This utility is available for **Rectangular** and **Circular** port types. Enter a **Relative permittivity** (default is 1) of the material fully filled in a waveguide and then click the **Compute Waveguide Cutoff Frequency** button to compute the cutoff frequency for the particular waveguide geometry and the selected **Mode type**. The result is displayed in the **Messages** window.

#### DE-EMBEDDING PORT

Set the **Port Offset**  $d_{\text{offset}}$  (SI unit: m) for the de-embedded S-parameter calculation. The default is 0 m. The phase of the de-embedded S-parameters is adjusted from the calculated S-parameters with the propagation constant and the value of  $d_{\text{offset}}$ .

$$\text{De-embedded } S_{nm} = S_{nm} \exp(j\beta_n d_n) \exp(j\beta_m d_m)$$

where  $m$  is the source port name,  $n$  is the listener port name,  $\beta$  is propagation constant, and  $d$  is offset distance from the port boundary.



The de-embedding functionality is triggered when  $d_{\text{offset}}$  is set to a nonzero value. It is assumed that the domain between the port boundary and the boundary projected by the  $d_{\text{offset}}$  is straight, while maintaining a constant cross-sectional shape.

#### CONSTRAINT SETTINGS

To display this section, click the **Show More Options** button (  ) and select **Advanced Physics Options** in the **Show More Options** dialog box. For information about the

**Constraint Settings** section, see [Constraint Settings](#) in the *COMSOL Multiphysics Reference Manual*.

---

	<ul style="list-style-type: none"><li>• <a href="#">S-Parameters and Ports</a></li><li>• <a href="#">S-Parameter Variables</a></li></ul>
	<p>3D model with numeric ports — <i>Waveguide Adapter</i>: Application Library path <b>RF_Module/Transmission_Lines_and_Waveguides/waveguide_adapter</b></p> <p>2D model with rectangular ports — <i>Three-Port Ferrite Circulator</i>: Application Library path <b>RF_Module/Ferrimagnetic_Devices/circulator</b></p> <p>2D model with periodic ports — <i>Plasmonic Wire Grating</i>: Application Library path <b>RF_Module/Tutorials/plasmonic_wire_grating</b></p> <p>3D model using slit conditions — <i>Frequency Selective Surface, Periodic Complementary Split Ring Resonator</i>: Application Library path <b>RF_Module/EMI_EMG_Applications/frequency_selective_surface_csrr</b></p>

---

### *Integration Line for Current*

---

The **Integration Line for Current** is available only in 3D from the context menu (right-click the [Port](#) node) when the **Analyze as a TEM field** check box is selected under the **Port Properties** section for the [Port](#) node.

### *Integration Line for Voltage*

---

The **Integration Line for Voltage** is available only in 3D from the context menu (right-click the [Port](#) node) when the **Analyze as a TEM field** check box is selected under the **Port Properties** section for the [Port](#) node. The characteristic impedance of a **Numeric** port is defined by the ratio between the voltage and current.

### *Ground*

---

The **Ground** subnode is available from the context menu (right-click the [Port](#) node) when **Transverse electromagnetic (TEM)** is selected as the type of port. Zero potential is assigned on the boundary selection in the port mode field calculation.

## *Electric Potential*

---

The **Electric Potential** subnode is available from the context menu (right-click the **Port** node) when **Transverse electromagnetic (TEM)** is selected as the type of port. Either positive or negative 1 V is assigned on the boundary selection in the port mode field calculation.

### **ELECTRIC POTENTIAL**

Select the **Electric mode potential** — **Positive electric potential** (the default) or **Negative electric potential** to specify positive or negative 1 V on the boundary selection.

## *Circular Port Reference Axis*

---

The **Circular Port Reference Axis** is available only in 3D. When the **Type of port** is set to **Circular** under **Port Properties**, the **Circular Port Reference Axis** subnode is available from the context menu (right-click the **Port** parent node) or from the **Physics** toolbar, **Attributes** menu. Two points are used to define the orientation of fields on a port boundary. If there are more than two points on the selection list, the first and last points are used. For the fundamental  $TE_{11}$  mode, the direction of the reference axis corresponds to the polarization of the electric field at the port center.

The following figure shows an example of a selection of two points for defining the **Circular Port Reference Axis**.

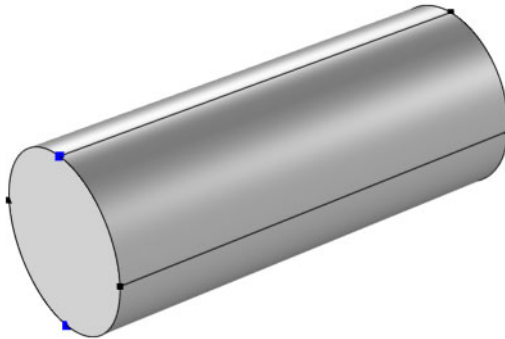

## Diffraction Order

---

The **Diffraction Order** port is available in 3D and 2D. When the **Type of Port** is set to **Periodic** under [Port Properties](#), this subnode is available from the context menu (right-click the [Port](#) parent node) or from the **Physics** toolbar, **Attributes** menu.

Use the **Diffraction Order** port to define diffraction orders from a periodic structure. Normally a **Diffraction Order** node is added automatically during the **Periodic** port setup. Additional **Diffraction Order** ports subnodes are available from the context menu (right-click the parent node) or from the **Physics** toolbar, **Attributes** menu.

### PORT PROPERTIES

Enter a unique **Port name**. Only nonnegative integer numbers can be used as **Port name** as it is used to define the elements of the S-parameter matrix and numeric port names are also required for port sweeps and Touchstone file export.

The Diffraction Order port is a listener port feature.

### PORT MODE SETTINGS

These settings define the diffracted plane wave.

#### Components

Select the **Components** setting for the port — **In-plane vector** (the default) or **Out-of-plane vector**.

#### Diffraction Order

Specify an integer constant or an integer parameter expression for the **Diffraction order**  $m$  (the default is 0) and in 3D  $n$  (the default is 0).

Note that **In-plane vector** and **Out-of-plane vector** are based on the plane of diffraction which is constructed with the diffraction wave vector and the outward normal vector of the port boundary. The diffraction wave vector is defined by

$$\mathbf{k}_{\text{diffraction,parallel}} = \mathbf{k}_F + m\mathbf{G}_1 + n\mathbf{G}_2$$
$$\mathbf{k}_{\text{diffraction}} = \mathbf{k}_{\text{diffraction,parallel}} + \mathbf{n}k_{\text{diffraction,perpendicular}}$$
$$k_{\text{diffraction,perpendicular}} = \sqrt{k^2 - k_{\text{diffraction,parallel}}^2}$$

where  $m$  and  $n$  are diffraction orders,  $k \geq k_{\text{diffraction,parallel}}$ ,  $k$  is the magnitude of the wave vector and  $k_{\text{diffraction,parallel}}$  is the magnitude of  $\mathbf{k}_{\text{diffraction,parallel}}$ . The reciprocal lattice vectors,  $\mathbf{G}_1$  and  $\mathbf{G}_2$  are defined from [Periodic Port Reference Point](#).



**In-plane vector** lies on the plane of diffraction while **Out-of-plane vector** is normal to the plane of diffraction.

For a 2D component, **In-plane vector** is available when the settings for the physics interface is set to either **In-plane vector** or **Three-component vector** under [Components](#). **Out-of-plane vector** is available when the settings for the physics interface is set to either **Out-of-plane vector** or **Three-component vector** under [Components](#).

In 2D, the diffraction wave vector is defined by

$$\mathbf{k}_{\text{diffraction,parallel}} = \mathbf{k}_F + m\mathbf{G}_1,$$

where the reciprocal lattice vector is defined by

$$\mathbf{G}_1 = \frac{2\pi}{a} \mathbf{n} \times \mathbf{z},$$

where  $\mathbf{n}$  is the port boundary normal and  $\mathbf{z}$  is the unit vector in the out-of-plane direction. Since the normal  $\mathbf{n}$  points in opposite directions for the exciting port boundary and the transmission side port boundary,  $\mathbf{G}_1$  will point in different directions on the two opposing port boundaries. Thereby, also the mode numbers for the two port boundaries will be different. For example, mode  $m = 1$  on the excitation side, corresponds to mode  $m = -1$  on the transmission side.

Enter a value or expression for the **Mode phase**  $\theta_m$  (SI unit: rad). The default is 0 radians. The **Mode phase** setting is further discussed for the [Port](#) feature.



Notice that the mode field defined for the Periodic port assumes homogeneous isotropic material properties in the domain adjacent to the selected port boundary.

For more details about the periodic port mode fields, see [Periodic Port Mode Fields](#)



- [S-Parameters and Ports](#)
- [S-Parameter Variables](#)



*Plasmonic Wire Grating*: Application Library path **RF\_Module/Tutorials/plasmonic\_wire\_grating**

## Orthogonal Polarization

---

The **Orthogonal Polarization** port is available in 3D and 2D. When the **Type of Port** is set to **Periodic** under [Port Properties](#), this subnode is available from the context menu (right-click the [Port](#) parent node) or from the **Physics** toolbar, **Attributes** menu.

Use the **Orthogonal Polarization** port to define port with a mode that is orthogonal to the mode of the parent **Periodic Port**. Normally a **Orthogonal Polarization** node is added automatically during the **Periodic** port setup, but the **Orthogonal Polarization** port subnode is also available from the context menu (right-click the parent node) or from the **Physics** toolbar, **Attributes** menu. Only one **Orthogonal Polarization** node can be added per parent **Periodic Port**.

### PORT PROPERTIES

Enter a unique **Port name**. Only nonnegative integer numbers can be used as **Port name** as it is used to define the elements of the S-parameter matrix and numeric port names are also required for port sweeps and Touchstone file export.

The **Orthogonal Polarization** port is a listener port feature.

### PORT MODE SETTINGS

#### *Diffraction Order*

The **Orthogonal Polarization** port represent a zero-order mode (same as assumed for the parent Periodic port). Thus, the **Diffraction order** settings are just for information and cannot be edited.

Enter a value or expression for the **Mode phase**  $\theta_m$  (SI unit: rad). The default is 0 radians. The **Mode phase** setting is further discussed for the [Port](#) feature.



Notice that the mode field defined for the Periodic port assumes homogeneous isotropic material properties in the domain adjacent to the selected port boundary.

For more details about the periodic port mode fields, see [Periodic Port Mode Fields](#)

---



- [S-Parameters and Ports](#)
  - [S-Parameter Variables](#)
-

## Periodic Port Reference Point

---

The **Periodic Port Reference Point** subnode is available only in 3D. When the **Type of Port** is set to **Periodic** under **Port Properties**, this subnode is available from the context menu (right-click the **Port** parent node) or from the **Physics** toolbar, **Attributes** menu.

The **Periodic Port Reference Point** is used to uniquely identify two primitive unit cell vectors,  $\mathbf{a}_1$  and  $\mathbf{a}_2$ , and two reciprocal lattice vectors,  $\mathbf{G}_1$  and  $\mathbf{G}_2$ . These reciprocal vectors are defined in terms of the unit cell vectors,  $\mathbf{a}_1$  and  $\mathbf{a}_2$ , tangent to the edges shared between the port and the adjacent periodic boundary conditions.  $\mathbf{G}_1$  and  $\mathbf{G}_2$  are defined by the relation

$$\frac{\mathbf{a}_1 \times \mathbf{a}_2}{|\mathbf{a}_1 \times \mathbf{a}_2|} = \mathbf{n}$$
$$\mathbf{G}_1 = 2\pi \frac{\mathbf{a}_2 \times \mathbf{n}}{\mathbf{a}_1 \cdot \mathbf{a}_2 \times \mathbf{n}} \quad \text{and} \quad \mathbf{G}_2 = 2\pi \frac{\mathbf{n} \times \mathbf{a}_1}{\mathbf{a}_1 \cdot \mathbf{a}_2 \times \mathbf{n}}$$

where  $\mathbf{n}$  is the outward unit normal vector to the port boundary.

### POINT SELECTION

The primitive unit cell vectors,  $\mathbf{a}_1$  and  $\mathbf{a}_2$  are defined from two edges sharing the **Periodic Port Reference Point** on a port boundary. The two vectors can have unequal lengths and are not necessarily orthogonal. They start from the **Periodic Port Reference Point**.

For listener (passive, observation, and not excited) ports, if the outward normal vector on the listener port boundary is opposite to that of the source port, the listener port reference point needs to be mirrored from the source port reference point based on the center coordinate of the model domain. For example, if the source port reference point is at  $\{-1, -1, 1\}$  in a cubic domain around the origin, the mirrored listener port reference point is  $\{1, 1, -1\}$ . In this example, if the first and second primitive unit cell vectors are  $\mathbf{a}_1$  and  $\mathbf{a}_2$  on the source port, the first and second primitive unit cell vectors on the listener port will be  $-\mathbf{a}_2$  and  $-\mathbf{a}_1$ , respectively, as the cross product between the first and second primitive unit cell vectors must point in the direction of the port normal. On the listener port, the normal points in the opposite direction to the normal on the source port. With the sign changes and the primitive unit cell vector index swaps, between the source and the listener ports, also the grating vectors change sign and swap indices, comparing the source and listener ports. Thus, the mode numbers

will also be different on the listener port compared to the mode numbers on the source port.

If the lattice vectors are collinear with two Cartesian axes, then the lattice vectors can be defined without the **Periodic Port Reference Point**. For the port where  $\mathbf{n}$  points along a positive Cartesian direction,  $\mathbf{a}_1$  and  $\mathbf{a}_2$  are also assigned to point along positive Cartesian directions. Conversely, for the port where  $\mathbf{n}$  points along a negative Cartesian direction,  $\mathbf{a}_1$  and  $\mathbf{a}_2$  are assigned to point along negative Cartesian directions. The condition  $\mathbf{a}_1 \times \mathbf{a}_2 \parallel \mathbf{n}$  is true on both ports. For example, if  $\mathbf{n} = \mathbf{z}$ , then  $\mathbf{a}_1/|\mathbf{a}_1| = \mathbf{x}$  and  $\mathbf{a}_2/|\mathbf{a}_2| = \mathbf{y}$  and if  $\mathbf{n} = -\mathbf{z}$ , then  $\mathbf{a}_1/|\mathbf{a}_1| = -\mathbf{y}$  and  $\mathbf{a}_2/|\mathbf{a}_2| = -\mathbf{x}$ .



*Plasmonic Wire Grating*: Application Library path **RF\_Module/Tutorials/plasmonic\_wire\_grating**

---

### *Lumped Port*

---

Use the **Lumped Port** node to apply a voltage or current excitation of a model or to connect to a circuit. A lumped port is a simplification of the port boundary condition.

A **Lumped Port** condition can only be applied on boundaries that extend between two metallic boundaries — that is, boundaries where **Perfect Electric Conductor**, **Impedance Boundary**, **Transition Boundary**, or **Layered Transition Boundary** (Electromagnetic Waves, Frequency Domain interface only) conditions apply — separated by a distance much smaller than the wavelength.

#### **LUMPED PORT PROPERTIES**

Enter a unique **Lumped port name**. It is recommended to use a numeric name as it is used to define the elements of the S-parameter matrix and numeric port names are also required for port sweeps and Touchstone file export (for the Electromagnetic Waves, Frequency Domain interface).

#### *Type of Lumped Port*

Select a **Type of lumped port** — **Coaxial**, **Multielement uniform**, **Uniform**, **User defined**, or **Via**.

Select **User defined** for nonuniform ports, for example, a curved port and enter values or expressions in the fields — **Height of lumped port**  $h_{\text{port}}$  (SI unit: m), **Width of lumped port**  $w_{\text{port}}$  (SI unit: m), and **Direction between lumped port terminals**  $\mathbf{a}_h$ . In 2D axisymmetry, **Coaxial** does not support a nonzero azimuthal mode number. The **Azimuthal mode number** should be set to zero in the **Out-of-Plane Wave Number** section

in the settings for [The Electromagnetic Waves, Frequency Domain Interface](#). When it is modeled in 3D, its geometry has to be a full coaxial shape.



Notice that the input field for **Direction between lumped port terminals**  $a_h$  is not shown in 2D, when **Electric field components solved for** is set to **Out-of-plane vector** in the **Components** section for the physics interface. In this case the **Direction between lumped port terminals**  $a_h$  is defined to be in the out-of-plane direction.



A partial geometry can also be analyzed with proper symmetry conditions such as symmetry planes or perfect magnetic conductors on the cut boundaries parallel to the electric field polarization. However, if symmetry planes are not used, then the characteristic impedance needs to be adjusted proportionally to the ratio between the full and partial geometry areas. For instance, the user-specified characteristic impedance of a half coaxial cable should be twice that of the full geometry.

Select **Multielement uniform** for multiexcitation or termination of, for example, a coplanar waveguide port or a differential port. The direction of the field in each sub-element of the **Multielement uniform** lumped port is defined by the subnodes, **Uniform element**.

Select **Via** for excitation or termination of a cylindrical shape of a structure used in a metalized via that is a plated through hole.

#### *Terminal Type*

Select a **Terminal type** — a **Cable** port for a voltage driven transmission line and S-parameter calculation, a **Current** driven port, or a **Circuit** port.

For **Cable**, select **On** or **Off** from the **Wave excitation at this port** list to set whether it is an inport (excitation) or a listener port (observation).

## SETTINGS

#### *Source Type*

If **On** is selected for the **Wave excitation at this port**, select **Voltage** or **Power** from the **Source type**. For the **Voltage** source type, enter a **Voltage**  $V_0$  (SI unit: V), and **Port phase**

$\theta_{in}$  (SI unit: rad). For the **Power** source type, enter a **Power**  $P_0$  (SI unit: W) that is the average input power to the lumped port.

Note it is only possible to excite one **Cable** port at a time if the purpose is to compute S-parameters. In other cases, for example, when studying microwave heating, more than one inport might be wanted, but the S-parameter variables cannot be correctly computed so if several ports are excited, the S-parameter output is turned off.

For the Electromagnetic Waves, Frequency Domain and Microwave Heating interfaces, the [Port Sweep Settings](#) cycles through the ports, computes the entire S-matrix, and exports it to a Touchstone file. When using port sweeps, the local setting for **Wave excitation at this port** is overridden by the solver so only one port at a time is excited.

No entry is required if a **Circuit** terminal type is selected above.

- For a **Cable** terminal type enter the **Characteristic impedance**  $Z_{ref}$  (SI unit:  $\Omega$ ). When using a lumped port on a partial geometry combined with symmetry plane features, enter the value for the full geometry if the **Characteristic impedance adjustment by symmetry plane** check box is marked.
- For a **Current** terminal type enter a **Terminal current**  $I_0$  (SI unit: A).

#### *Coaxial*

The following figure shows an example of a boundary selection for a **Coaxial** lumped port in a 3D model.

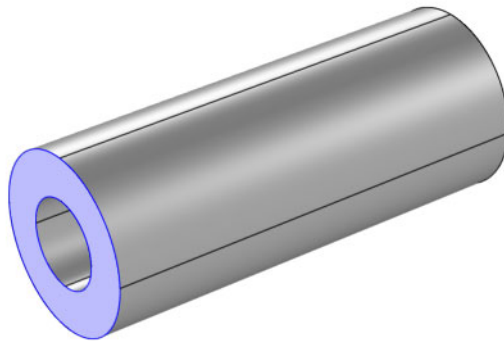

#### **COAXIAL LINE IMPEDANCE CALCULATOR**

Enter a **Relative permittivity** (default is 1) for the dielectric material between the coaxial inner and outer conductor and then click the **Compute Coaxial Line Impedance** button

to compute the impedance for the coaxial lumped port. The result is displayed in the **Messages** window.

#### *Multielement Uniform*

The following figure shows an example of a boundary selection for a **Multielement uniform** lumped port in a 3D model.

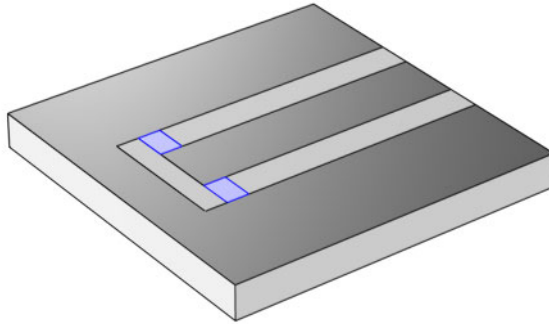

#### *Uniform*

The following figure shows an example of a boundary selection for a **Uniform** lumped port in a 3D model.

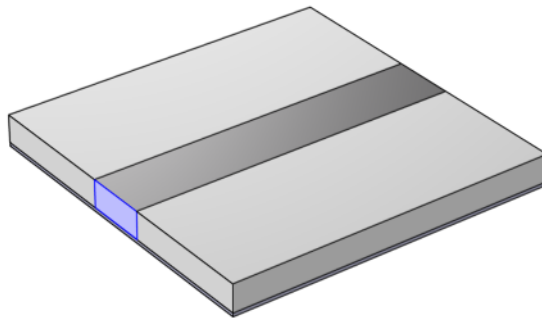

### Via

The following figure shows an example of a boundary selection for a **Via** lumped port in a 3D model.

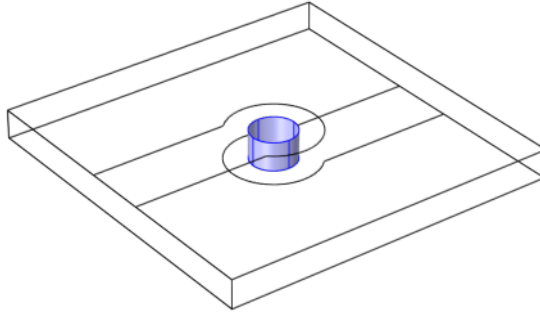

### Calculate S-parameter

The **Calculate S-parameter** check box needs to be selected for S-parameter calculation with the Electromagnetic Waves, Transient and Electromagnetic Waves, Time Explicit interfaces, while the **Cable** port in the Electromagnetic Wave, Frequency Domain calculates S-parameters automatically.

### Voltage Source Type

When **Calculate S-parameter** is selected, select **Voltage source type** from the list (default **Modulated Gaussian pulse**). The **Modulated Gaussian pulse** is defined as

$$\frac{2f_0}{\sqrt{2\pi}} e^{-\frac{(t-2/f_0)^2}{2/(2f_0)^2}} \cdot \sin(2\pi \cdot (1 + \eta_f) \cdot f_0 t)$$

where the **Center frequency**  $f_0$  defines the location as  $2/f_0$ , the standard deviation as  $1/(2f_0)$ , and the modulation frequency  $f_0$ .  $\eta_f$  is the upshift ratio for the sinusoidal modulation frequency.

The modulating sinusoidal function can be slightly shifted from the center frequency  $f_0$  by a factor of  $1 + \eta_f$  to improve the frequency responses.

### Center Frequency

When **Calculate S-parameter** is selected, enter a **Center frequency**  $f_0$  for the input modulated Gaussian pulse (SI unit: Hz).



### Modulation Frequency Upshift Ratio

When **Calculate S-parameter** is selected, enter a **Modulation frequency upshift ratio**  $\eta_f$  for the input modulated Gaussian pulse.



- S-Parameters and Ports
- Lumped Ports with Voltage Input



As a multiport device example, *Branch-Line Coupler*: Application Library path **RF\_Module/Couplers\_and\_Power\_Dividers/branch\_line\_coupler**

For example of how to use the **Multielement uniform** lumped port, *Coplanar Waveguide Bandpass Filter*: Application Library path **RF\_Module/Filters/cpw\_bandpass\_filter**

### Current Pulse Type

In the Electromagnetic Waves, Transient interface, when **Terminal type** is set to **Current**, select **Current Pulse Type** from **User defined**, **Electrostatic discharge**, and **Lightning**.

Enter pulse model parameter values and click the **Plot Pulse Shape** button to inspect the current pulse instantly as a function of time before running a simulation.

### Electrostatic Discharge Pulse Model

When **Current Pulse Type** is set to **Electrostatic discharge**, select **Electrostatic Discharge Pulse Model** from **Human body model**, **Extended human body model**, **Machine model**, and **Charged device model**.

### Lumped Element

Use a **Lumped Element** node to mimic the insertion of a capacitor, inductor, or general impedance between two metallic boundaries. A **Lumped Element** condition is a passive lumped port boundary condition which cannot be used as a source. Unlike a **Lumped Port**, it does not generate S-parameters. The sign of the current and power of a **Lumped Element** is opposite to that of a **Lumped Port**.

It can only be applied on boundaries that extend between two metallic boundaries — that is, boundaries where **Perfect Electric Conductor**, **Impedance Boundary**, **Transition Boundary**, or **Layered Transition Boundary** (Electromagnetic Waves, Frequency Domain interface only) conditions apply — separated by a distance much smaller than the wavelength.

## LUMPED ELEMENT PROPERTIES

Enter a unique **Lumped element name**. See [Lumped Port](#) for the rest of the settings.

### SETTINGS

Select a **Lumped element device** — **User defined** (the default), **Inductor**, **Capacitor**, **Parallel LC**, **Series LC**, **Parallel RLC**, or **Series RLC**. **Inductor**, **Capacitor**, **Parallel LC**, **Series LC**, **Parallel RLC**, and **Series RLC** are available only in the frequency domain study type.

- For **User defined** enter a **Lumped element impedance**  $Z_{\text{element}}$  (SI unit:  $\Omega$ ). The default is 50  $\Omega$ .
- For **Inductor**, **Parallel LC**, **Series LC**, **Parallel RLC**, or **Series RLC** enter a **Lumped element inductance**  $L_{\text{element}}$  (SI unit: H). The default is 1 nH.
- For **Capacitor**, **Parallel LC**, **Series LC**, **Parallel RLC**, or **Series RLC** enter a **Lumped element capacitance**  $C_{\text{element}}$  (SI unit: F). The default is 1 pF.
- For **Parallel RLC**, or **Series RLC** enter a **Lumped element resistance**  $R_{\text{element}}$  (SI unit:  $\Omega$ ). The default is 50  $\Omega$ .

### *Uniform*

The following figure shows an example of a boundary selection for a **Uniform** lumped element in a 3D model.

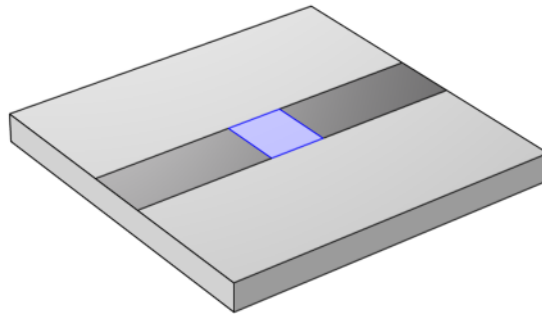

See [Lumped Port](#) for the boundary selection example figures used in other types of lumped elements.

### CALCULATOR

Enter a **Relative permittivity** (default is 1) for the dielectric material between the coaxial inner and outer conductor and then click the **Compute Coaxial Line Impedance** button

to compute the impedance for the coaxial lumped element. The result is displayed in the **Messages** window.



*SMA Connectorized Wilkinson Power Divider*: Application Library path  
**RF\_Module/Couplers\_and\_Power\_Dividers/wilkinson\_power\_divider**

### *Uniform Element*

The **Uniform Element** is available in 3D. When the **Type of lumped port** is set to **Multielement uniform** under [Lumped Port Properties](#), this subnode is available from the context menu (right-click the [Lumped Port](#) parent node) or from the **Physics** toolbar, **Attributes** menu.

#### **PORT PROPERTIES**

Enter a unique **Uniform element name**. Enter values or expressions in the fields — **Direction between uniform element terminals**  $\mathbf{a}_h$ . The **Direction between uniform element terminals** defines the electric potential polarity, as  $\mathbf{a}_h$  points in the direction of the electric field.

### *Electric Field*

The **Electric Field** boundary condition

$$\mathbf{n} \times \mathbf{E} = \mathbf{n} \times \mathbf{E}_0$$

specifies the tangential component of the electric field. As the equation suggests, the boundary condition only guarantees that the tangential components of  $\mathbf{E}$  and  $\mathbf{E}_0$  are equal. Their normal components might deviate depending on specific situations. It should in general not be used to excite a model. Consider using the [Port](#), [Lumped Port](#), or [Scattering Boundary Condition](#) instead. It is provided mainly for completeness and for advanced users who can recognize the special modeling situations when it is appropriate to use. The commonly used special case of zero tangential electric field is described in the [Perfect Electric Conductor](#) section.

#### **ELECTRIC FIELD**

Enter the value or expression for the components of the **Electric field**  $\mathbf{E}_0$  (SI unit: V/m).

## CONSTRAINT SETTINGS

To display this section, click the **Show More Options** button (  ) and select **Advanced Physics Options** in the **Show More Options** dialog box. For information about the **Constraint Settings** section, see [Constraint Settings](#) in the *COMSOL Multiphysics Reference Manual*.

### *Magnetic Field*

---

The **Magnetic Field** node adds a boundary condition for specifying the tangential component of the magnetic field at the boundary:

$$\mathbf{n} \times \mathbf{H} = \mathbf{n} \times \mathbf{H}_0$$

## MAGNETIC FIELD

Enter the value or expression for the components of the **Magnetic field**  $\mathbf{H}_0$  (SI unit: A/m).

### *Scattering Boundary Condition*

---

Use the **Scattering Boundary Condition** to make a boundary transparent for a scattered wave. The boundary condition is also transparent for an incoming plane wave. The scattered (outgoing) wave types for which the boundary condition is perfectly transparent are

$\mathbf{E} = \mathbf{E}_{sc} e^{-jk(\mathbf{n} \cdot \mathbf{r})} + \mathbf{E}_0 e^{-jk(\mathbf{k} \cdot \mathbf{r})}$	Plane scattered wave
$\mathbf{E} = \mathbf{E}_{sc} \frac{e^{-jk(\mathbf{n} \cdot \mathbf{r})}}{\sqrt{r}} + \mathbf{E}_0 e^{-jk(\mathbf{k} \cdot \mathbf{r})}$	Cylindrical scattered wave
$\mathbf{E} = \mathbf{E}_{sc} \frac{e^{-jk(\mathbf{n} \cdot \mathbf{r})}}{r_s} + \mathbf{E}_0 e^{-jk(\mathbf{k} \cdot \mathbf{r})}$	Spherical scattered wave

The field  $\mathbf{E}_0$  is the incident plane wave that travels in the direction  $\mathbf{k}$ . The boundary condition is transparent for incoming (but not outgoing) plane waves with any angle of incidence. In addition, to an incident plane wave,  $\mathbf{E}_0$  can also be the electric field distribution for a Gaussian beam that propagates in the direction  $\mathbf{k}$ .

If there is an incident field, a [Reference Point](#) subnode can be added by right-clicking the context menu (right-click the parent node) or from the **Physics** toolbar, **Attributes** menu. The [Reference Point](#) subnode redefines the incident field to be expressed as

$$\mathbf{E}_0 e^{-jk(\mathbf{k} \cdot (\mathbf{r} - \mathbf{r}_{\text{ref}}))},$$

where  $\mathbf{r}_{\text{ref}}$  is a reference point determined by the [Reference Point](#) subnode. If no reference point subnode is added, the reference point is calculated as the average position boundary selection.



In 2D axisymmetry, when incident field can be specified, the default subnode [Symmetry Axis Reference Point](#) is available. This subnode defines a reference point at the intersection between the symmetry axis and the Scattering boundary condition's boundary selection.

The boundary is only perfectly transparent for scattered (outgoing) waves of the selected type at normal incidence to the boundary. That is, a plane wave at oblique incidence is partially reflected and so is a cylindrical wave or spherical wave unless the wave fronts are parallel to the boundary. For the Electromagnetic Waves, Frequency Domain interface, the Perfectly Matched Layer feature is available as a general way of modeling an open boundary.

- For cylindrical waves, specify around which cylinder axis the waves are cylindrical. Do this by specifying one point at the cylinder axis and the axis direction.
- For spherical waves, specify the center of the sphere around which the wave is spherical.

The domain material adjacent to the boundary where the Scattering Boundary Condition is applied can be lossy.

If the problem is solved for the eigenfrequency or the scattered field, the boundary condition does not include the incident wave.

$$\mathbf{E}_{\text{sc}} = \mathbf{E}_{\text{sc}} e^{-jk(\mathbf{n} \cdot \mathbf{r})} \quad \text{Plane scattered wave}$$

$$\mathbf{E}_{\text{sc}} = \mathbf{E}_{\text{sc}} \frac{e^{-jk(\mathbf{n} \cdot \mathbf{r})}}{\sqrt{r}} \quad \text{Cylindrical scattered wave}$$

$$\mathbf{E}_{\text{sc}} = \mathbf{E}_{\text{sc}} \frac{e^{-jk(\mathbf{n} \cdot \mathbf{r})}}{r_s} \quad \text{Spherical scattered wave}$$



In the scattered field formulation, the background field must be a solution to the wave equation in the domain adjacent to the Scattering Boundary Condition feature. If the background field is not a solution to the wave equation in the adjacent domain, there will be reflections at the boundary.

So, if the scattering problem consists of a scatterer embedded in a top superstrate and a bottom substrate, a structure similar to what is used in the tutorial model *Plasmonic Wire Grating*, the background field should be either a numerical or analytical solution to the two-layer superstrate-substrate problem.

#### SCATTERING BOUNDARY CONDITION

Select an **Incident field** — **No incident field** (the default), **Wave given by E field**, **Wave given by H field**, or **Gaussian beam**. Enter the expressions for the components for the **Incident electric field  $\mathbf{E}_0$**  or **Incident magnetic field  $\mathbf{H}_0$** .

If the **Incident field** is set to **Gaussian beam**, select an **Input quantity**: **Electric field amplitude** (the default) or **Power**. If the **Input quantity** is **Electric field amplitude**, enter the component expressions for the **Gaussian beam electric field amplitude  $\mathbf{E}_{g0}$**  (SI unit: V/m). If the **Input quantity** is set to **Power**, enter the **Input power** (SI unit: W in 2D axisymmetry and 3D and W/m in 2D) and the component expressions for the **Gaussian beam non-normalized electric field amplitude  $\mathbf{E}_{g0}$**  (SI unit: V/m). Also edit the **Beam radius  $w_0$**  (SI unit: m) and the **Distance to focal plane  $p_0$**  (SI unit: m). The default values are  $((10 \cdot 2) \cdot \pi) / \text{emw} \cdot k_0$  and 0 m, respectively. The optical axis for the Gaussian beam is defined by a line including a reference point on the feature selection with a direction specified by the **Incident wave direction** (see below). By default, the reference point is the average position for the feature selection. However, by adding a [Reference Point](#) subnode any available point (or the average of several selected points) on the feature selection can be used as the reference point. The focal plane for the Gaussian

beam is located the **Distance to focal plane**  $p_0$  from the reference point in the **Incident wave direction**.

If the **Incident field** is not set to **No incident field**, edit the **Incident wave direction**  $\mathbf{k}_{\text{dir}}$  for the vector coordinates. The default direction is in the opposite direction to the boundary normal. For 2D axisymmetry, the **Incident wave direction**  $\mathbf{k}_{\text{dir}}$  should be parallel or anti-parallel to the symmetry axis.

Select a **Scattered wave type** for which the boundary is absorbing — **Plane wave** (the default), **Spherical wave**, or **Cylindrical wave**.

- For the Electromagnetic Waves, Frequency Domain interface, select an **Order** — **First order** (the default) or **Second order**.
- For **Cylindrical wave** also enter coordinates for the **Source point**  $\mathbf{r}_0$  (SI unit: m) and **Source axis direction**  $\mathbf{r}_{\text{axis}}$  (dimensionless). For 2D the **Source axis direction** is assumed to be in the  $z$  direction, whereas in 2D axisymmetry it is assumed to be along the axis of rotation.
- For **Spherical wave** enter coordinates for the **Source point**  $\mathbf{r}_0$  (SI unit: m).

#### MODE ANALYSIS

Expand the **Mode Analysis** section and check the **Subtract propagation constant from material wave number** check box to calculate the wave number for the scattered wave as

$$k_n = \sqrt{k^2 - \beta^2},$$

where  $k_n$  is the wave number for the scattered wave propagating in the normal direction,  $k$  is the material wave number, and  $\beta$  is the propagation constant, determined from the mode analysis. If the check box is cleared (the default),  $k_n = k$ .



For more information about the Gaussian beam theory, see [Gaussian Beams as Background Fields and Input Fields](#).



*Conical Antenna*: Application Library path **RF\_Module/Antennas/conical\_antenna**

#### INITIAL VALUES FOR INCIDENT WAVE

For the Electromagnetic Waves, Transient interface enter the components for the initial value of the **Magnetic vector potential**  $\mathbf{A}_0$  (SI unit: Wb/m).

## DISPERSION AND ABSORPTION

This section is only available for the Electromagnetic Waves, Transient interface. To display it, click the **Show More Options** button (  ) and select **Advanced Physics Options** in the **Show More Options** dialog box.

Select the **Dispersion and absorption model** that will be used when calculating the wave number and attenuation constant for the incident and scattered waves — **Low loss approximation** (the default), or **High loss**. For **High loss** also enter a **Carrier frequency**  $f_0$  (SI unit: Hz). The default is 1 GHz.

When the **Dispersion and absorption model** is set to **Low loss approximation** the refractive index is calculated from the relative permittivity and the relative permeability as

$$n = \sqrt{\epsilon_r \mu_r}.$$

Similarly, the absorption coefficient is calculated as

$$\gamma = \frac{1}{2} \sigma \sqrt{\frac{\mu_0 \mu_r}{\epsilon_0 \epsilon_r}} = \frac{1}{2} \sigma Z_c,$$

where  $Z_c$  is the characteristic impedance.



When the **Dispersion and absorption model** is set to **High loss**, the real and the imaginary parts of the complex refractive index is solved for from the real and the imaginary parts of the relative permittivity, using the relations

$$n^2 - \kappa^2 = \epsilon'_r \mu_r$$

and

$$2n\kappa = \epsilon''_r \mu_r = \frac{\sigma \mu_r}{\omega \epsilon_0}.$$

The absorption coefficient is then given by

$$\gamma = \frac{\omega}{c} \kappa.$$



## Reference Point

---

The **Reference Point** subnode is available only when there is an available incident field defined in the parent node. Then this subnode is available from the context menu (right-click the **Scattering Boundary Condition** parent node) or from the **Physics** toolbar, **Attributes** menu.

The **Reference Point** subnode defines a reference position  $\mathbf{r}_{\text{ref}}$  that is calculated as the average position from the point selection in the **Reference Point** subnode or as a user-defined position on the parent feature boundary.

In the parent node, the incident field is then defined using the reference position:

$$\mathbf{E}_0 e^{-jk(\mathbf{k} \cdot (\mathbf{r} - \mathbf{r}_{\text{ref}}))}.$$

### POINT SELECTION

Select the points that should be used when calculating the reference position. The reference position is calculated as the average position of the selected points. The point selection is only effective when **Definition** in the **Reference Point** section is set to **Point selection**.

### REFERENCE POINT

Select the **Definition** for the reference point — **Point selection** (the default) or **User defined**. When **User defined** is selected, enter the expressions for the components for the **Reference point**  $r_0$ . The **Reference point** must be a point on the parent feature's boundary selection.

## Symmetry Axis Reference Point

---

The **Symmetry Axis Reference Point** subnode is available in 2D axisymmetry, when there is an incident field defined in the parent node. Then this subnode is available as a default subnode to the **Scattering Boundary Condition** parent node.

The **Symmetry Axis Reference Point** subnode defines a reference position  $\mathbf{r}_{\text{ref}}$  at the intersection point between the parent node's boundary selection and the symmetry axis. If the parent selection does not intersect the symmetry axis, the reference point is defined by the parent node's selection or an added **Reference Point** subnode to the parent node.

In the parent node, the incident field is then defined using the reference position:

$$\mathbf{E}_0 e^{-jk(\mathbf{k} \cdot (\mathbf{r} - \mathbf{r}_{ref}))}$$

## *Impedance Boundary Condition*

---

### The **Impedance Boundary Condition**

$$\sqrt{\frac{\mu_0 \mu_r}{\epsilon_c}} \mathbf{n} \times \mathbf{H} + \mathbf{E} - (\mathbf{n} \cdot \mathbf{E}) \mathbf{n} = (\mathbf{n} \cdot \mathbf{E}_s) \mathbf{n} - \mathbf{E}_s$$

is used at boundaries where the field is known to penetrate only a short distance outside the boundary. This penetration is approximated by a boundary condition to avoid the need to include another domain in the model. Although the equation is identical to the one in the low-reflecting boundary condition, it has a different interpretation. The material properties are for the domain outside the boundary and not inside, as for low-reflecting boundaries. A requirement for this boundary condition to be a valid approximation is that the magnitude of the complex refractive index

$$N = \sqrt{\frac{\mu \epsilon_c}{\mu_1 \epsilon_1}}$$

where  $\mu_1$  and  $\epsilon_1$  are the material properties of the inner domain, is large; that is,  $|N| \gg 1$ .

The source electric field  $\mathbf{E}_s$  can be used to specify a source surface current on the boundary.

The [Surface Roughness](#) subnode is available from the context menu (right-click the parent node) or from the **Physics** toolbar, **Attributes** menu.

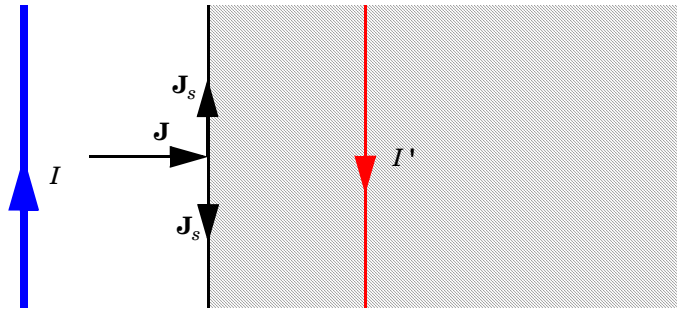



Figure 4-5: The impedance boundary condition is used on exterior boundaries representing the surface of a lossy domain. The shaded (lossy) region is not part of the model. The effective induced image currents are of reduced magnitude due to losses. Any current flowing into the boundary is perfectly balanced by induced surface currents as for the perfect electric conductor boundary condition. The tangential electric field is generally small but nonzero at the boundary.

#### IMPEDANCE BOUNDARY CONDITION

Select an **Electric displacement field model** — **Relative permittivity** (the default), **Refractive index**, **Loss tangent**, **loss angle**, **Loss tangent**, **dissipation factor**, **Dielectric loss**, **Drude-Lorentz dispersion model**, or **Debye dispersion model**. See the [Wave Equation](#), [Electric](#) node, [Electric Displacement Field](#) section, for all settings.

#### SOURCE ELECTRIC FIELD

To display this section, click the **Show More Options** button (  ) and select **Advanced Physics Options** in the **Show More Options** dialog box.

Enter a **Source electric field**  $\mathbf{E}_s$  (SI unit: V/m). The default is 0 V/m.

See *Skin Depth Calculator* to evaluate the skin depth of a homogeneous material.



Impedance boundary conditions can be applied to domains that deselect the physics within those domains and instead apply the boundary condition to exterior boundaries of the domains. Using the domain feature may reduce the number of steps defining selections.



*Coaxial to Waveguide Coupling*: Application Library path **RF\_Module/Transmission\_Lines\_and\_Waveguides/coaxial\_waveguide\_coupling**

*Computing Q Factors and Resonant Frequencies of Cavity Resonators*: Application Library path **RF\_Module/Verification\_Examples/cavity\_resonators**

---

## *Surface Current Density*

---

The **Surface Current Density** boundary condition

$$\begin{aligned} -\mathbf{n} \times \mathbf{H} &= \mathbf{J}_s \\ \mathbf{n}_2 \times (\mathbf{H}_1 - \mathbf{H}_2) &= \mathbf{J}_s \end{aligned}$$

specifies a surface current density at both exterior and interior boundaries, respectively. The current density is specified as a three-dimensional vector, but because it needs to flow along the boundary surface, COMSOL Multiphysics projects it onto the boundary surface and neglects its normal component. This makes it easier to specify the current density and avoids unexpected results when a current density with a component normal to the surface is given.

For [Transition Boundary Condition](#), the **Surface Current Density** subnode as an one-sided surface current density is available from the context menu (right-click the Transition Boundary Condition parent node) or from the **Physics** toolbar, **Attributes** menu.

### **SURFACE CURRENT DENSITY**

Enter values or expressions for the components of the **Surface current density**  $\mathbf{J}_{s0}$  (SI unit: A/m).

For the **Surface Current Density** subnode, select **Side** — **Upside** (the default) or **Downside** to define on which side the **Surface Current Density** is applied. The red arrow visualized on the selected boundaries always indicates the upside.

---

## *Surface Magnetic Current Density*

---

The **Surface Magnetic Current Density** boundary condition

$$\begin{aligned} \mathbf{n} \times \mathbf{E} &= \mathbf{J}_{ms} \\ \mathbf{n}_2 \times (\mathbf{E}_1 - \mathbf{E}_2) &= -\mathbf{J}_{ms} \end{aligned}$$

specifies a surface magnetic current density at both exterior and interior boundaries, respectively. The magnetic current density is specified as a three-dimensional vector, but because it needs to flow along the boundary surface, COMSOL Multiphysics projects it onto the boundary surface and neglects its normal component. This makes it easier to specify the magnetic current density and avoids unexpected results when a magnetic current density with a component normal to the surface is given.

### **SURFACE MAGNETIC CURRENT DENSITY**

Enter values or expressions for the components of the **Surface magnetic current density**  $\mathbf{J}_{ms0}$  (SI unit: V/m).

### **CONSTRAINT SETTINGS**

To display this section, click the **Show More Options** button (  ) and select **Advanced Physics Options** in the **Show More Options** dialog box. For information about the **Constraint Settings** section, see [Constraint Settings](#) in the *COMSOL Multiphysics Reference Manual*.

## *Surface Roughness*

---

The **Surface Roughness** subnode is available from the context menu (right-click the [Impedance Boundary Condition](#) or [Transition Boundary Condition](#) parent node) or from the **Physics** toolbar, **Attributes** menu.

### **SURFACE ROUGHNESS**

Select a **Surface roughness model** — **Sawtooth** (the default) or **Snowball**. For **Sawtooth**, enter a value or expression for the **Surface roughness**  $\Delta_{RMS}$  (SI unit: m). For **Snowball**, enter a **Snowball hexagon cell area**  $A_{hex}$  (SI unit:  $m^2$ ). Then enter values for the **Snowball radius** (SI unit: m) and **Number of snowballs** in the table, adding as many rows as you need.

Select the **Skin depth type** to be **Physics-controlled** (the default) or **User defined**. For **User defined**, enter the **Skin depth**  $\delta$  (SI unit: m).

The **Surface Roughness** increases the impedance, and consequently it decreases the surface current density of [Impedance Boundary Condition](#) or [Transition Boundary Condition](#), proportional to the ratio between the impedance of a rough surface and that of a smooth surface:

### SAWTOOTH MODEL

$$Z_{\text{rough}} = Z_{\text{smooth}} \cdot \left[ 1 + \frac{2}{\pi} \operatorname{atan} \left( (1.4) \left( \frac{A_{\text{RMS}}}{\delta} \right)^2 \right) \right]$$

where  $\Delta_{\text{RMS}}$  is the root mean square of the surface roughness, and  $\delta$  is the skip depth of the material (Ref. 1).

### SNOWBALL MODEL

$$Z_{\text{rough}} = Z_{\text{smooth}} \cdot \left[ 1 + \frac{3}{2} \sum_i \left( \frac{N_i \cdot 4\pi a_i^2}{A_{\text{hex}}} \right) \left( 1 + \frac{\delta}{a_i} + \frac{\delta^2}{a_i^2} \right) \right]$$

where  $A_{\text{hex}}$  is the hexagonal area of a unit cell,  $N_i$  is the number of snowballs,  $a_i$  is the radius of a snowball, and  $\delta$  is the skip depth of the material (Ref. 2).

For Transition Boundary Condition, select **Side** — **Upside** (the default) or **Downside** to define on which side the **Surface Roughness** is applied. The red arrow visualized on the selected boundaries always indicates the upside.

#### References

1. E. Hammerstad, O. Jensen, “Accurate Models for Microstrip Computer-Aided Design”, *Microwave symposium Digest, 1980 IEEE MTT-S International*, pp. 407–409, May 1980
2. P.G. Huray, *The Foundation of Signal Integrity*, Wiley-IEEE Press, 2010

### *Transition Boundary Condition*

---

The **Transition Boundary Condition** is used on interior boundaries to model a sheet of a medium that should be geometrically thin but does not have to be electrically thin. It represents a discontinuity in the tangential electric field. Mathematically it is described by a relation between the electric field discontinuity and the induced surface current density:

$$\mathbf{J}_{s1} = \frac{(Z_S \mathbf{E}_{t1} - Z_T \mathbf{E}_{t2})}{Z_S^2 - Z_T^2}$$

$$\mathbf{J}_{s2} = \frac{(Z_S \mathbf{E}_{t2} - Z_T \mathbf{E}_{t1})}{Z_S^2 - Z_T^2}$$

$$Z_S = \frac{-j\omega\mu}{k} \frac{1}{\tan(kd)}$$

$$Z_T = \frac{-j\omega\mu}{k} \frac{1}{\sin(kd)}$$

$$k = \omega\sqrt{(\varepsilon + (\sigma/(j\omega)))\mu}$$

where indices 1 and 2 refer to the different sides of the layer. This feature is not available with the Electromagnetic Waves, Transient interface.



The **Transition Boundary Condition** is based on the assumption that the wave propagates in the normal direction in the thin layer. Thus, the wave could be incident in the normal direction or the wave could be refracted to propagate in a direction close to the normal direction. The latter condition is fulfilled for a good conductor.

The thickness of the layer should also be less than the radius of curvature for the boundary.

A consequence of the normal direction propagation assumption is that the **Transition Boundary Condition** is not compatible with mode analysis, as for mode analysis it is assumed that the wave predominantly propagates in the out-of-plane direction whereas the normal to the boundary is in an in-plane direction.

The [Surface Roughness](#) and [Surface Current Density](#) subnodes are available from the context menu (right-click the parent node) or from the **Physics** toolbar, **Attributes** menu.

#### TRANSITION BOUNDARY CONDITION

Select an **Electric displacement field model** — **Relative permittivity** (the default), **Refractive index**, **Loss tangent**, **loss angle**, **Loss tangent, dissipation factor**, **Dielectric loss**, **Drude-Lorentz dispersion model**, or **Debye dispersion model**. See the [Wave Equation](#), [Electric](#) node, [Electric Displacement Field](#) section, for all settings.

Select the **Electrically thick layer** check box (cleared by default) to make the two domains adjacent to the boundary uncoupled. Use this setting, for instance, when the thickness is greater than three times of the skin depth. When the **Electrically thick layer** check box is cleared, enter a **Thickness**  $d$  (SI unit: m). The default is 0.01 m.

#### SKIN DEPTH CALCULATOR

Select a **Defined by** option — **Electrical conductivity** (default) or **Resistivity**. Enter a **Electrical conductivity**  $\sigma$  (SI unit: S/m), Relative permittivity  $\epsilon_r$ , Relative permeability  $\mu_r$  of the material to be evaluated, and frequency  $f_0$  (SI unit: Hz). Then click the **Compute Skin Depth** button to compute the skin depth for the particular material specified by the above input values. The result is displayed in the settings window below the **Compute Skin Depth** button.

#### *Layered Transition Boundary Condition*

---

The **Layered Transition Boundary Condition** is an extension of the **Transition Boundary Condition** that allows to model a sequence of geometrically thin layers using a **Layered Material**. It represents a discontinuity in the tangential electric field. For each layer in the **Layered Material**, the transfer and surface impedances are obtained from the layer thickness and material properties. The impedances are then used to relate the discontinuity in the tangential electric field to the current flowing on the surface of either side (up/down) of the corresponding layer. Mathematically this reads:

$$\mathbf{J}_{s, \text{up}, i} = \frac{(Z_S \mathbf{E}_{t, i} - Z_T \mathbf{E}_{t, i-1})}{Z_S^2 - Z_T^2}$$

$$\mathbf{J}_{s, \text{down}, i} = \frac{(Z_S \mathbf{E}_{t, i-1} - Z_T \mathbf{E}_{t, i})}{Z_S^2 - Z_T^2}$$

$$Z_S = \frac{-j\omega\mu}{k} \frac{1}{\tan(kd)}$$

$$Z_T = \frac{-j\omega\mu}{k} \frac{1}{\sin(kd)}$$

$$k = \omega \sqrt{(\epsilon + (\sigma/(j\omega)))\mu}$$

where the index  $i = 1, 2, \dots, n$  refers to the layer number. The system of equations above is solved for each layer in the **Layered Material**. The index  $i$  has been omitted from the



expressions of the impedances and the wave vector  $k$  in order to improve their readability.

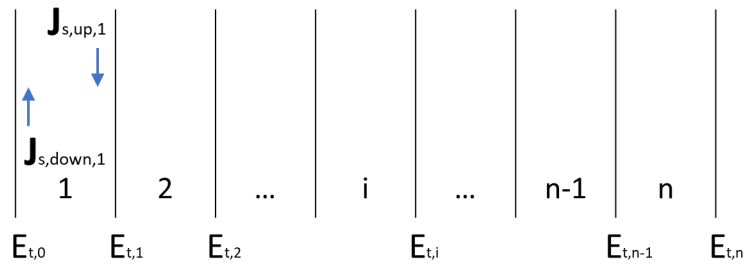

Figure 4-6: The layered material is composed of  $n$  layers. The surface currents on the up and downside of each layer are determined from the transfer and surface impedances and are functions of the tangential electric fields.



- See [Layered Material](#), [Layered Material Link](#), [Layered Material Stack](#), [Layered Material Link \(Subnode\)](#), and [Single Layer Materials](#) in the *COMSOL Multiphysics Reference Manual* for details on the definition of layered materials.



The **Layered Transition Boundary Condition** is based on the assumption that the wave propagates in the normal direction in the thin layer. Thus, the wave could be incident in the normal direction or the wave could be refracted to propagate in a direction close to the normal direction. The latter condition is fulfilled for a good conductor.

The thickness of the layer should be less than the radius of curvature for the boundary.

A consequence of the normal direction propagation assumption is that the **Layered Transition Boundary Condition** is not compatible with mode analysis, as for mode analysis it is assumed that the wave predominantly propagates in the out-of-plane direction whereas the normal to the boundary is in an in-plane direction.

## SHELL PROPERTIES

The **Shell Properties** section displays which **Layered Material** the **Layered Transition Boundary Condition** is coupled to.

Clear the **Use all layers** check box in order to select a specific **Layered Material** from the list. The **Layered Transition Boundary Condition** feature is then applicable only on the boundaries where the chosen material is defined.

You can visualize the selected **Layered Material** and the layers that constitute it by clicking the **Layer Cross Section Preview** and **Layer 3D Preview** buttons.

The thickness of the **Layered Material** should be set as follows, depending on the type of material:

- In a **Material** node, the layer **Thickness** is set in the **Material Contents** section by adding a **Shell** property group from the **Material Properties** section in the material **Settings** window. This automatically adds a **Shell** subnode under the **Material** node, transforming it into a **Layered Material**.
- When the **Layered Material** is a **Single Layer Material**, the **Thickness** is set in the **Material Contents** section in the **Settings** window. Alternatively it can be set in the **Layer Definition** section of the **Shell** property group **Settings** window.
- For a general **Layered Material**, added through a **Layered Material Link** or a **Layered Material Stack**, the **Thickness** is set in the **Layer Definition** section of the **Settings** window. Several layers may be defined in the table, and the **Thickness** should be defined for each of them. The total thickness of the **Layered Material** is the sum of all the layers thicknesses.

#### LAYERED TRANSITION BOUNDARY CONDITION

Select an **Electric displacement field model** — **Relative permittivity** (the default), **Refractive index**, **Loss tangent**, **loss angle**, **Loss tangent**, **dissipation factor**, **Dielectric loss**, **Drude-Lorentz dispersion model**, or **Debye dispersion model**. See the [Wave Equation](#), [Electric](#) node, [Electric Displacement Field](#) section, for all settings.

The defaults use the values **From material**, taking the properties from the **Layered Material** specified for the boundary. Otherwise, choose **User defined** and enter different values or expressions. In the latter case all layers constituting the chosen **Layered Material** will take on the same value for the selected property.

See *Skin Depth Calculator* to evaluate the skin depth of a homogeneous material.



*Rat-Race Coupler*: Application Library path **RF\_Module/ Couplers\_and\_Power\_Dividers/rat\_race\_coupler**

---

## Layered Impedance Boundary Condition

---

The **Layered Impedance Boundary Condition** is an extension of the **Impedance Boundary Condition** that allows to model a sequence of geometrically thin layers on top of a substrate. It is used on exterior boundaries where the field is known to penetrate only a short distance outside the boundary. In brief, this feature combines a **Layered Transition Boundary Condition** with an **Impedance Boundary Condition** of the type:

$$\sqrt{\frac{\mu_0 \mu_r}{\epsilon_c}} \mathbf{n} \times \mathbf{H} + \mathbf{E} - (\mathbf{n} \cdot \mathbf{E}) \mathbf{n} = 0.$$

The layer stack is built using a **Layered Material**. For each layer in the **Layered Material**, the transfer and surface impedances are obtained from the layer thickness and the material properties. The impedances are then used to relate the discontinuity in the tangential electric field to the current flowing on the surface of either side (up/down) of the corresponding layer. The mathematical details relative to the field propagation in the layer stack can be found in the [Layered Transition Boundary Condition](#) section.



- See [Layered Material](#), [Layered Material Link](#), [Layered Material Stack](#), [Layered Material Link \(Subnode\)](#), and [Single Layer Materials](#) in the *COMSOL Multiphysics Reference Manual* for details on the definition of layered materials.



The **Layered Impedance Boundary Condition** is based on the assumption that in the thin layers and in the substrate the wave propagates essentially in the normal direction. Thus, the wave could be incident in the normal direction or the wave could be refracted to propagate in a direction close to the normal direction. The latter condition is fulfilled for a good conductor.

The thickness of the layer should be less than the radius of curvature for the boundary.

---

### SHELL PROPERTIES

The **Shell Properties** section displays which **Layered Material** is coupled to the **Layered Impedance Boundary Condition**.

Clear the **Use all layers** check box in order to select a specific **Layered Material** from the list. The **Layered Impedance Boundary Condition** feature is then applicable only on the boundaries where the chosen **Layered Material** is defined.

You can visualize the selected **Layered Material** and the layers that constitute it by clicking the **Layer Cross Section Preview** and **Layer 3D Preview** buttons.

The thickness of the **Layered Material** should be set as follows, depending on the type of material:

- For a general **Layered Material**, added through a **Layered Material Link** or a **Layered Material Stack**, the **Thickness** is set in the **Layer Definition** section of the **Settings** window. Several layers may be defined in the table, and the **Thickness** should be defined for each of them. The total thickness of the **Layered Material** is the sum of all the layers thicknesses.
- When the **Layered Material** is a **Single Layer Material**, the **Thickness** is set in the **Material Contents** section in the **Settings** window. Alternatively it can be set in the **Layer Definition** section of the **Shell** property group **Settings** window.
- In a **Material** node, the layer **Thickness** is set in the **Material Contents** section by adding a **Shell** property group from the **Material Properties** section in the material **Settings** window. This automatically adds a **Shell** subnode under the **Material** node, transforming it into a **Layered Material**.

#### LAYER PROPERTIES

The **Layer Properties** section specifies the material properties of the thin layers constituting the stack located on top of the substrate. Select an **Electric displacement field model** — **Relative permittivity** (the default), **Refractive index**, **Loss tangent**, **loss angle**, **Loss tangent**, **dissipation factor**, **Dielectric loss**, **Drude-Lorentz dispersion model**, or **Debye dispersion model**. See the [Wave Equation, Electric](#) node, [Electric Displacement Field](#) section, for all settings.

The defaults use the values **From material**. In this case, the material properties are taken layer by layer from the **Layered Material** existing on those boundaries where the **Layered Impedance Boundary Condition** feature is enabled. Otherwise, choose **User defined** and enter a value or an expression. In the latter case all layers constituting the chosen **Layered Material** will take on the same given value for the selected material property.

#### SUBSTRATE PROPERTIES

The **Substrate Properties** section specifies the material properties of the thick domain that is not included in the model, being approximated by an **Impedance Boundary**

**Condition.** Select a **Substrate Material** from the list of materials that have been introduced in the model previously. Select an **Electric displacement field model** — **Relative permittivity** (the default), **Refractive index**, **Loss tangent, loss angle**, **Loss tangent, dissipation factor**, **Dielectric loss**, **Drude-Lorentz dispersion model**, or **Debye dispersion model**. See the [Wave Equation](#), [Electric](#) node, [Electric Displacement Field](#) section, for all settings.

The defaults use the values **From material**. In this case, the material properties are taken from the specified **Substrate Material**. Otherwise, choose **User defined** and enter a value or an expression.

See *Skin Depth Calculator* to evaluate the skin depth of a homogeneous material.

### *Periodic Condition*

---

The **Periodic Condition** sets up a periodicity between the selected boundaries.

#### **BOUNDARY SELECTION**



The software usually automatically identifies the boundaries as either source boundaries or destination boundaries, as indicated in the selection list. This works fine for cases like opposing parallel boundaries. In other cases, right-click **Periodic Condition** and select **Manual Destination Selection** to control the destination. By default it contains the selection that COMSOL Multiphysics identifies.

#### **DESTINATION SELECTION**

This section is available for specifying the destination boundaries, if needed, when the **Manual Destination Selection** option is selected in the context menu for the **Periodic Condition** node. You can only select destination boundaries from the union of all source and destination boundaries.

#### **COORDINATE SYSTEM SELECTION**

Select a coordinate system for the periodic condition from the **Coordinate system** list. The default is the **Global coordinate system**.

## PERIODICITY SETTINGS

Select a **Type of periodicity** — **Continuity** (the default), **Antiperiodicity**, or **Floquet periodicity**. Select:

- **Continuity** to make the electric field periodic (equal on the source and destination),
- **Antiperiodicity** to make it antiperiodic, or
- **Floquet periodicity** ([The Electromagnetic Waves, Frequency Domain Interface](#) only) to use a Floquet periodicity (Bloch-Floquet periodicity).
  - For **Floquet periodicity** also enter the source for the **k-vector for Floquet periodicity**.
  - For **User defined** specify the components of the **k-vector for Floquet periodicity**  $\mathbf{k}_F$  (SI unit: rad/m).
  - For **From periodic port** the **k-vector for Floquet periodicity**  $\mathbf{k}_F$  is obtained from the **Periodic Port** settings.

## CONSTRAINT SETTINGS

To display this section, click the **Show More Options** button (  ) and select **Advanced Physics Options** in the **Show More Options** dialog box. For information about the **Constraint Settings** section, see [Constraint Settings](#) in the *COMSOL Multiphysics Reference Manual*.

## ORIENTATION OF SOURCE

To display this section, click the **Show More Options** button (  ) and select **Advanced Physics Options** in the **Show More Options** dialog box. For information about the **Orientation of Source** section, see [Orientation of Source and Destination](#) in the *COMSOL Multiphysics Reference Manual*.

## ORIENTATION OF DESTINATION



This section appears if the setting for **Transform to intermediate map** in the **Orientation of Source** section is changed from the default value, **Automatic**, and **Advanced Physics Options** is selected in the **Show More Options** dialog box. For information about the **Orientation of Destination** section, see [Orientation of Source and Destination](#) in the *COMSOL Multiphysics Reference Manual*.

## MAPPING BETWEEN SOURCE AND DESTINATION

To display this section, click the **Show More Options** button (  ) and select **Advanced Physics Options** in the **Show More Options** dialog box. For information about the

**Mapping Between Source and Destination** section, see [Mapping Between Source and Destination](#) in the *COMSOL Multiphysics Reference Manual*.

---

	<a href="#">Periodic Boundary Conditions</a>
	<ul style="list-style-type: none"><li>• <i>Fresnel Equations</i>: Application Library path <b>RF_Module/Verification_Examples/fresnel_equations</b></li><li>• <i>Plasmonic Wire Grating</i>: Application Library path <b>RF_Module/Tutorials/plasmonic_wire_grating</b></li></ul>

---

### *Magnetic Current*

---

The **Magnetic Current** node specifies a magnetic line current along one or more edges. For a single **Magnetic Current** source, the electric field is orthogonal to both the line and the distance vector from the line to the field point. For 2D and 2D axisymmetric models the **Magnetic Current** node is applied to **Points**, representing magnetic currents directed out of the model plane. For 3D models, the **Magnetic Current** is applied to **Edges**.

#### **MAGNETIC CURRENT**

Enter a value for the **Magnetic current**  $I_m$  (SI unit: V).

### *Two-Port Network*

---

Use the **Two-Port Network** node to characterize the response of a two-port network system such as reflection and transmission using S-parameters.

A **Two-Port Network** can only be applied on boundaries that extend between two metallic boundaries — that is, boundaries where **Perfect Electric Conductor**, **Impedance Boundary**, or **Transition Boundary** conditions apply — separated by a distance much smaller than the wavelength.

#### **TWO-PORT NETWORK PROPERTIES**

##### *Type of Port*

Select a **Type of Port** — **Coaxial** or **Uniform**.

**Coaxial** does not support nonzero azimuthal mode number. The **Azimuthal mode number** in the **Physics interface** should be defined as zero.

#### *Type of S-parameter Definition*

Select a **Type of S-parameter Definition** — **Matrix** or **Touchstone file**.

**Matrix** defines the S-parameter by a constant matrix input. **Touchstone file** imports a two-port Touchstone file to characterize the two-port boundaries as a function of frequency.

#### **SETTINGS**

Enter the **Characteristic impedance**  $Z_{\text{ref}}$  (SI unit:  $\Omega$ ) for **Matrix**.

#### **INTERPOLATION AND EXTRAPOLATION**

Select **Interpolation** and **Extrapolation** types to obtain S-parameter values from the imported Touchstone file corresponding to the simulation frequencies.

#### *Interpolation*

Select a **Interpolation** — **Nearest neighbor**, **Linear**, **Piecewise cubic** (the default), or **Cubic spline**.

The S-parameter values are interpolated within the frequency range specified in the Touchstone file.

#### *Extrapolation*

Select a **Extrapolation** — **Constant** (the default), **Linear**, **Nearest function**, or **Specific value**.

The S-parameter values are extrapolated outside the frequency range specified in the Touchstone file.



*Filter Characterized by Imported S-Parameters via a Touchstone File:*  
Application Library path **RF\_Module/Filters/two\_port\_network\_touchstone**

---

#### *Two-Port Network Port*

A pair of **Two-Port Network Port** subnodes is added by default to the **Two-Port Network** node and is used to select boundaries corresponding to port 1 and port 2 in the S-parameter input, respectively.



## *Three-Port Network*

---

Use the **Three-Port Network** node to characterize the response of a three-port network system such as reflection and transmission using S-parameters.

A **Three-Port Network** can only be applied on boundaries that extend between two metallic boundaries — that is, boundaries where **Perfect Electric Conductor**, **Impedance Boundary**, or **Transition Boundary** conditions apply — separated by a distance much smaller than the wavelength.

### **THREE-PORT NETWORK PROPERTIES**

#### *Type of Port*

Select a **Type of Port** — **Coaxial** or **Uniform**.

**Coaxial** does not support nonzero azimuthal mode number. The **Azimuthal mode number** in the **Physics interface** should be defined as zero.

#### *Type of S-parameter Definition*

Select a **Type of S-parameter Definition** — **Matrix** or **Touchstone file**.

**Matrix** defines the S-parameter by a constant matrix input. **Touchstone file** imports a three-port Touchstone file to characterize the three-port boundaries as a function of frequency.

### **SETTINGS**

Enter the **Characteristic impedance**  $Z_{\text{ref}}$  (SI unit:  $\Omega$ ) for **Matrix**.

### **INTERPOLATION AND EXTRAPOLATION**

Select **Interpolation** and **Extrapolation** types to obtain S-parameter values from the imported Touchstone file corresponding to the simulation frequencies.

#### *Interpolation*

Select a **Interpolation** — **Nearest neighbor**, **Linear**, **Piecewise cubic** (the default), or **Cubic spline**.

The S-parameter values are interpolated within the frequency range specified in the Touchstone file.

#### *Extrapolation*

Select a **Extrapolation** — **Constant** (the default), **Linear**, **Nearest function**, or **Specific value**.

The S-parameter values are extrapolated outside the frequency range specified in the Touchstone file.

### *Three-Port Network Port*

---

A combination of **Three-Port Network Port** subnodes is added by default to the **Three-Port Network** node and is used to select boundaries corresponding to port 1, port 2, and port 3 in the S-parameter input, respectively.

### *Four-Port Network*

---

Use the **Four-Port Network** node to characterize the response of a four-port network system such as reflection and transmission using S-parameters.

A **Four-Port Network** can only be applied on boundaries that extend between two metallic boundaries — that is, boundaries where **Perfect Electric Conductor**, **Impedance Boundary**, or **Transition Boundary** conditions apply — separated by a distance much smaller than the wavelength.

## **FOUR-PORT NETWORK PROPERTIES**

### *Type of Port*

Select a **Type of Port** — **Coaxial** or **Uniform**.

**Coaxial** does not support nonzero azimuthal mode number. The **Azimuthal mode number** in the **Physics interface** should be defined as zero.

### *Type of S-parameter Definition*

Select a **Type of S-parameter Definition** — **Matrix** or **Touchstone file**.

**Matrix** defines the S-parameter by a constant matrix input. **Touchstone file** imports a four-port Touchstone file to characterize the four-port boundaries as a function of frequency.

## **SETTINGS**

Enter the **Characteristic impedance**  $Z_{\text{ref}}$  (SI unit:  $\Omega$ ) for **Matrix**.

## **INTERPOLATION AND EXTRAPOLATION**

Select **Interpolation** and **Extrapolation** types to obtain S-parameter values from the imported Touchstone file corresponding to the simulation frequencies.

### *Interpolation*

Select a **Interpolation** — **Nearest neighbor**, **Linear**, **Piecewise cubic** (the default), or **Cubic spline**.

The S-parameter values are interpolated within the frequency range specified in the Touchstone file.

### *Extrapolation*

Select a **Extrapolation** — **Constant** (the default), **Linear**, **Nearest function**, or **Specific value**.

The S-parameter values are extrapolated outside the frequency range specified in the Touchstone file.

### *Four-Port Network Port*

---

A combination of **Four-Port Network Port** subnodes is added by default to the **Four-Port Network** node and is used to select boundaries corresponding to port 1, port 2, port 3, and port 4 in the S-parameter input, respectively.

### *Mixed Mode S-Parameters*

---

To calculate the mixed mode S-parameters of a four-port network, add a **Mixed Mode S-parameters** global feature and specify port names for each balanced pair. The mixed mode S-parameter calculation requires to perform a parametric sweep with four ports to obtain a full 4 by 4 S-parameter matrix.

#### **BALANCED PORT**

Specify **Port name for port a in balanced pair 1**, **Port name for port b in balanced pair 1**, **Port name for port c in balanced pair 2**, and **Port name for port d in balanced pair 2**.

These must be matched to the port names specified in the (lumped) port features of the four-port system.



*Mixed-Mode S-Parameters Analysis*: Application Library path  
**RF\_Module/EMI\_EMC\_Applications/microstrip\_line\_mixed\_mode**

---

## Symmetry Plane

---

The **Symmetry Plane** node adds a boundary condition that represents symmetry in the electric or magnetic field, depending on which option is chosen.

### SYMMETRY TYPE

Choose between **Zero tangential electric field (PEC)** and **Zero tangential magnetic field (PMC)** for the electric field. If **Zero tangential electric field** is chosen, the boundary condition is

$$\mathbf{n} \times \mathbf{E} = \mathbf{0}$$

which states that the tangential components of the electric field are zero. It behaves as [Perfect Electric Conductor](#). Use this symmetry type when there is only the normal component of the electric field on the symmetry boundaries. If **Zero tangential magnetic field** is chosen, the boundary condition becomes

$$\mathbf{n} \times \mathbf{H} = \mathbf{0}$$

which states that the tangential components of the magnetic field and the surface current density are zero. It behaves as [Perfect Magnetic Conductor](#). Use this symmetry type when there are only the tangential components of the electric field on the symmetry boundaries.



It is important to inspect the polarization on the plane where a symmetry plane feature is applied. The symmetry plane enforces a PEC or PMC condition and thereby suppresses the tangential field component of electric field or magnetic field on the plane, respectively. Some waveguides modes cannot be simplified using symmetry plane features. For instance, a **Zero tangential magnetic field (PMC)** symmetry plane cut at the center of a TE<sub>20</sub> rectangular waveguide mode can satisfy the boundary condition of the transverse electric field on a port boundary. However, the longitudinal magnetic field component in the waveguide is incorrectly suppressed by the symmetry plane.



*Microwave Oven*: Application Library path **RF\_Module/**  
**Microwave\_Heating/microwave\_oven**

## *Edge Current*

---

The **Edge Current** node specifies an electric line current along one or more edges.

### **EDGE CURRENT**

For the Electromagnetic Waves, Frequency Domain interface, enter an **Edge current**  $I_0$  (SI unit: A).

For the Electromagnetic Waves, Transient interface, select **Edge Current Type** from **User defined**, **Electrostatic discharge**, or **Lightning**. Enter pulse model parameter values and click the **Plot Pulse Shape** button to inspect the edge current pulse instantly as a function of time before running a simulation.

#### *User Defined*

Enter an **Edge current**  $I_0$  (SI unit: A).

#### *Electrostatic Discharge*

Select **Electrostatic Discharge Pulse Model** from **Human body model**, **Extended human body model**, **Machine model**, or **Charged device model**. Enter the values for the model parameters. Specify the expression for the **Parameterized path** (SI unit: m) and the **Pulse velocity** (SI unit: m/s). The default is set to the built-in variable  $s1$  and built-in constant  $c\_const$ . The expression for the **Parameterized path** should parameterize the edge where the **Edge Current** is applied.

#### *Lightning*

Enter the values for the model parameters. Specify the expression for the **Parameterized path** (SI unit: m) and the **Pulse velocity** (SI unit: m/s). The default is set to the built-in variables  $s1$  and built-in constant  $c\_const$ .

## *Electric Point Dipole*

---

Add **Electric Point Dipole** nodes to 3D and 2D models. This represents the limiting case of when the length  $d$  of a current filament carrying uniform current  $I$  approaches zero while maintaining the product between  $I$  and  $d$ . The dipole moment is a vector entity with the positive direction set by the current flow.

### **DIPOLE SPECIFICATION**

Select a **Dipole specification** — **Magnitude and direction** or **Dipole moment**.

## DIPOLE PARAMETERS

Based on the **Dipole specification** selection:

- For **Magnitude and direction** enter coordinates for the **Electric current dipole moment direction**  $\mathbf{n}_p$  and **Electric current dipole moment, magnitude**  $p$  (SI unit: A·m).
- For **Dipole moment** enter coordinates for the **Electric current dipole moment**  $\mathbf{p}$  (SI unit: A·m).

### *Magnetic Point Dipole*

---

Add a **Magnetic Point Dipole** to 3D and 2D models. The point dipole source represents a small circular current loop  $I$  in the limit of zero loop area  $a$  at a fixed product  $Ia$ .

## DIPOLE SPECIFICATION

Select a **Dipole specification** — **Magnitude and direction** or **Dipole moment**.

## DIPOLE PARAMETERS

Based on the **Dipole specification** selection:

- For **Magnitude and direction** enter coordinates for the **Magnetic dipole moment direction**  $\mathbf{n}_m$  and **Magnetic dipole moment, magnitude**  $m$  (SI unit:  $\text{m}^2 \cdot \text{A}$ ).
- For **Dipole moment** enter coordinates for the **Magnetic dipole moment**  $\mathbf{m}$  (SI unit:  $\text{m}^2 \cdot \text{A}$ ).

### *Line Current (Out-of-Plane)*

---

Add a **Line Current (Out-of-Plane)** node to 2D or 2D axisymmetric models. This specifies a line current out of the modeling plane. In axially symmetric geometries this is the rotational direction, in 2D geometries it is the  $z$  direction.

## LINE CURRENT (OUT-OF-PLANE)

Enter an **Out-of-plane current**  $I_0$  (SI unit: A).

### *Archie's Law*

---

This subfeature is available only when **Archie's law** is selected as the **Electrical conductivity** material parameter in the parent feature (for example, the **Wave Equation, Electric** node). Then the subnodes are made available from the context menu (right-click the parent node) as well as from the **Physics** toolbar, **Attributes** menu.

Use the **Archie's Law** subnode to provide an electrical conductivity computed using Archie's Law. This subnode can be used to model nonconductive effective medium saturated (or variably saturated) by conductive liquids, using the relation:

$$\sigma = s_L^n \varepsilon_p^m \sigma_L$$



## Archie's Law Theory

---

### CONDUCTION CURRENTS

By default, the **Electrical conductivity**  $\sigma_L$  (SI unit: S/m) for the fluid is defined **From material**. This uses the value of the conductivity of the material domain.

For **User defined** enter a value or expression. If another type of temperature dependence is used other than a linear temperature relation, enter any expression for the conductivity as a function of temperature.

Enter these dimensionless parameters as needed:

- **Cementation exponent**  $m$
- **Saturation exponent**  $n$
- **Fluid saturation**  $S_L$
- **Porosity**  $\varepsilon_p$  to set up the volume fraction of the fluid.

### *Effective Medium*

---

This subfeature is available only when **Effective medium** is selected as the material parameter (for example, **Relative permeability** or **Relative permittivity**) in the parent feature node when it is available with the physics interface (for example, the **Wave Equation, Electric** node). Then the subnodes are made available from the context menu (right-click the parent node) as well as from the **Physics** toolbar, **Attributes** menu.

Use the **Effective Medium** subfeature to specify the material properties of a domain consisting of a porous medium using a mixture model. Depending on the specific physics interface being used, the subfeature can be used to provide a mixture model for the electric conductivity  $\sigma$ , the relative dielectric permittivity  $\varepsilon_r$ , or the relative magnetic permeability  $\mu_r$ .

## EFFECTIVE MEDIUM

This section is always available and is used to define the mixture model for the domain.

Select the **Number of materials** (up to 5) to be included in the mixture model.

For each material (**Material 1**, **Material 2**, and so on), select either **Domain material**, to use the material specified for the domain, or one of the other materials specified in the **Materials** node. For each material, enter a **Volume fraction**  $\theta_1$ ,  $\theta_2$ , and so on.

The Volume fractions specified for the materials should be fractional (between 0 and 1) and should add to 1 in normal cases.



The availability of the **Effective Electrical Conductivity**, **Effective Relative Permittivity**, and **Effective Relative Permeability** sections depend on the material properties used in the physics interface. In addition, these sections are only active if **Effective medium** is selected in the corresponding material property for the parent feature node.

---

## EFFECTIVE ELECTRICAL CONDUCTIVITY, EFFECTIVE RELATIVE PERMITTIVITY, OR EFFECTIVE RELATIVE PERMEABILITY

Select the averaging method to use in the mixture model between the **Volume average** of the material property (for example, **conductivity** or **permittivity**), the volume average of its inverse (for example, the **resistivity**), or the **Power law**. For each material, specify either **From material**, to take the value from the corresponding material specified in the **Effective Medium** section, or **User defined** to manually input a value.





[Effective Conductivity in Effective Media and Mixtures](#)

---



# The Electromagnetic Waves, Transient Interface

The **Electromagnetic Waves, Transient (temw)** interface () , found under the **Radio Frequency** branch () when adding a physics interface, is used to solve a time-domain wave equation for the magnetic vector potential. The sources can be in the form of point dipoles, line currents, or incident fields on boundaries or domains. It is primarily used to model electromagnetic wave propagation in different media and structures when a time-domain solution is required — for example, for non-sinusoidal waveforms or for nonlinear media. Typical applications involve the propagation of electromagnetic pulses.

When this physics interface is added, these default nodes are also added to the **Model Builder** — **Wave Equation, Electric, Perfect Electric Conductor**, and **Initial Values**. Then, from the **Physics** toolbar, add other nodes that implement, for example, boundary conditions and mass sources. You can also right-click **Electromagnetic Waves, Transient** to select physics features from the context menu.

Except where indicated, most of the settings are the same as for [The Electromagnetic Waves, Frequency Domain Interface](#).

## SETTINGS

The **Label** is the default physics interface name.

The **Name** is used primarily as a scope prefix for variables defined by the physics interface. Refer to such physics interface variables in expressions using the pattern `<name>.<variable_name>`. In order to distinguish between variables belonging to different physics interfaces, the `name` string must be unique. Only letters, numbers, and underscores (`_`) are permitted in the **Name** field. The first character must be a letter.

The default **Name** (for the first physics interface in the model) is `temw`.

## COMPONENTS

This section is available for 2D and 2D axisymmetric components.

Select the **Electric field components solved for**. Select:

- **Three-component vector** (the default) to solve using a full three-component vector for the electric field  $\mathbf{E}$ .

- **Out-of-plane vector** to solve for the electric field vector component perpendicular to the modeling plane, assuming that there is no electric field in the plane.
- **In-plane vector** to solve for the electric field vector components in the modeling plane assuming that there is no electric field perpendicular to the plane.

#### DEPENDENT VARIABLES

The dependent variable (field variable) is for the **Magnetic vector potential  $A$** . The name can be changed but the names of fields and dependent variables must be unique within a model.

#### DISCRETIZATION

Select the shape order for the **Magnetic vector potential** dependent variable — **Linear**, **Quadratic** (the default), or **Cubic**. For more information about the **Discretization** section, see [Settings for the Discretization Sections](#) in the *COMSOL Multiphysics Reference Manual*.



- [Domain, Boundary, Edge, Point, and Pair Nodes for the Electromagnetic Waves, Transient Interface](#)
  - [Theory for the Electromagnetic Waves Interfaces](#)
- 



*Transient Modeling of a Coaxial Cable*: Application Library path  
**RF\_Module/Verification\_Examples/coaxial\_cable\_transient**

---

### *Domain, Boundary, Edge, Point, and Pair Nodes for the Electromagnetic Waves, Transient Interface*

---

The [Electromagnetic Waves, Transient Interface](#) shares most of its nodes with [The Electromagnetic Waves, Frequency Domain Interface](#).

The domain, boundary, edge, point, and pair nodes are available from the **Physics** ribbon toolbar (Windows users), **Physics** context menu (Mac or Linux users), or right-click to access the context menu (all users).



In general, to add a node, go to the **Physics** toolbar, no matter what operating system you are using. Subnodes are available by clicking the parent node and selecting it from the **Attributes** menu.

---

## DOMAIN

These nodes are unique for this physics interface and described in this section:

- [Wave Equation, Electric](#)
- [Initial Values](#)
- [Drude–Lorentz Polarization](#)
- [Far-Field Domain](#)
- [Far-Field Calculation](#)

## BOUNDARY CONDITIONS

With no surface currents present the boundary conditions

$$\mathbf{n}_2 \times (\mathbf{E}_1 - \mathbf{E}_2) = \mathbf{0}$$

$$\mathbf{n}_2 \times (\mathbf{H}_1 - \mathbf{H}_2) = \mathbf{0}$$

need to be fulfilled. Depending on the field being solved for, it is necessary to analyze these conditions differently. When solving for  $\mathbf{A}$ , the first condition can be formulated in the following way.

$$\mathbf{n}_2 \times (\mathbf{E}_1 - \mathbf{E}_2) = \mathbf{n}_2 \times \left( \frac{\partial \mathbf{A}_2}{\partial t} - \frac{\partial \mathbf{A}_1}{\partial t} \right) = \frac{\partial}{\partial t} (\mathbf{n}_2 \times (\mathbf{A}_2 - \mathbf{A}_1))$$

The tangential component of the magnetic vector potential is always continuous and thus the first condition is fulfilled. The second condition is equivalent to the natural boundary condition.

$$-\mathbf{n} \times (\mu_r^{-1} \nabla \times \mathbf{A}_1 - \mu_r^{-1} \nabla \times \mathbf{A}_2) = -\mathbf{n} \times \mu_r^{-1} (\mathbf{H}_1 - \mathbf{H}_2) = \mathbf{0}$$

and is therefore also fulfilled.

These nodes and subnodes are available and described for the Electromagnetic Waves, Frequency Domain interface (listed in alphabetical order):

- [Archie's Law](#)
- [Lumped Port](#)
- [Magnetic Field](#)
- [Perfect Electric Conductor](#)
- [Perfect Magnetic Conductor](#)
- [Periodic Condition](#)
- [Effective Medium](#)
- [Scattering Boundary Condition](#)
- [Surface Current Density](#)

## EDGE, POINT, AND PAIR

These edge, point, and pair nodes are available and described for the Electromagnetic Waves, Frequency Domain interface (listed in alphabetical order):

- [Edge Current](#)
- [Electric Point Dipole](#) (2D and 3D components)
- [Line Current \(Out-of-Plane\)](#) (2D and 2D axisymmetric components)
- [Magnetic Point Dipole](#) (2D and 3D components)
- [Perfect Electric Conductor](#)
- [Perfect Magnetic Conductor](#)
- [Surface Current Density](#)



For axisymmetric components, COMSOL Multiphysics takes the axial symmetry boundaries (at  $r = 0$ ) into account and automatically adds an **Axial Symmetry** node to the component that is valid on the axial symmetry boundaries only.



In the *COMSOL Multiphysics Reference Manual* see [Table 2-4](#) for links to common sections and [Table 2-5](#) to common feature nodes. You can also search for information: press F1 to open the **Help** window or Ctrl+F1 to open the **Documentation** window.

## *Wave Equation, Electric*

The **Wave Equation, Electric** node is the main node for the Electromagnetic Waves, Transient interface. The governing equation can be written in the form

$$\mu_0 \sigma \frac{\partial \mathbf{A}}{\partial t} + \mu_0 \epsilon_0 \frac{\partial}{\partial t} \left( \epsilon_r \frac{\partial \mathbf{A}}{\partial t} \right) + \nabla \times (\mu_r^{-1} \nabla \times \mathbf{A}) = 0$$

for transient problems with the constitutive relations  $\mathbf{B} = \mu_0 \mu_r \mathbf{H}$  and  $\mathbf{D} = \epsilon_0 \epsilon_r \mathbf{E}$ . Other constitutive relations can also be handled for transient problems. The **Divergence Constraint** subnode is available from the context menu (right-click the parent node) or from the **Physics** toolbar, **Attributes** menu.

## ELECTRIC DISPLACEMENT FIELD

Select an **Electric displacement field model** — **Relative permittivity** (the default), **Refractive index**, **Polarization**, **Remanent electric displacement**, or **Drude-Lorentz dispersion model**.

### *Relative Permittivity*

When **Relative permittivity** is selected, the default **Relative permittivity**  $\epsilon_r$  (dimensionless) takes values **From material**. For **User defined** select **Isotropic**, **Diagonal**, **Symmetric**, or **Full** and enter values or expressions in the field or matrix. If **Effective medium** is selected, the **Effective medium** subnode is available from the context menu (right-click the parent node) or from the **Physics** toolbar, **Attributes** menu.

### *Refractive Index*

When **Refractive index** is selected, the default **Refractive index**  $n$  (dimensionless) takes the value **From material**. To specify the refractive index and assume a relative permeability of unity and zero conductivity, for one or both of the options, select **User defined** then choose **Isotropic**, **Diagonal**, **Symmetric**, or **Full**. Enter values or expressions in the field or matrix.



Notice that only the real part of the refractive index is used for the transient formulation.

---

### *Polarization*

For **Polarization** enter coordinates for the **Polarization**  $\mathbf{P}$  (SI unit:  $C/m^2$ ).

### *Remanent Electric Displacement*

For **Remanent electric displacement** enter coordinates for the **Remanent electric displacement**  $\mathbf{D}_r$  (SI unit:  $C/m^2$ ). Then select **User defined** or **From Material** as above for the **Relative permittivity**  $\epsilon_r$ .

### *Drude-Lorentz Dispersion Model*

For **Drude-Lorentz dispersion model** select **User defined** or **From material** for the **Relative permittivity**, **high-frequency**  $\epsilon_\infty$  and enter a value for the **Plasma frequency**  $\omega_p$  (SI unit: rad/s).

When **Drude-Lorentz dispersion model** is selected, the **Drude-Lorentz Polarization** subnode is available from the context menu (right-click the parent node) or from the **Physics** toolbar, **Attributes** menu. Each **Drude-Lorentz Polarization** subnode adds another polarization term  $\mathbf{P}_n$  to the electric displacement field  $\mathbf{D}$ , defined by

$$\mathbf{D} = \varepsilon_0 \varepsilon_\infty \mathbf{E} + \sum_{n=1}^N \mathbf{P}_n,$$

where the polarization is the solution to the ordinary differential equation

$$\left( \frac{\partial^2}{\partial t^2} + \Gamma_n \frac{\partial}{\partial t} + \omega_n^2 \right) \mathbf{P}_n = \varepsilon_0 f_n \omega_p^2 \mathbf{E}.$$

For more information, see the [Drude–Lorentz Polarization](#) feature.

### MAGNETIC FIELD

This section is available if **Relative permittivity**, **Polarization**, or **Remanent electric displacement** are chosen as the **Electric displacement field model**.

Select the **Constitutive relation** — **Relative permeability** (the default), **Remanent flux density**, or **Magnetization**.

#### *Relative Permeability*

For **Relative permeability** the relative permeability  $\mu_r$  uses values **From material**. For **User defined** select **Isotropic**, **Diagonal**, **Symmetric**, or **Full** based on the characteristics of the magnetic field, and then enter values or expressions in the field or matrix. If **Effective medium** is selected, the **Effective medium** subnode is available from the context menu (right-click the parent node) or from the **Physics** toolbar, **Attributes** menu.

#### *Remanent Flux Density*

For **Remanent flux density** the relative permeability  $\mu_r$  uses values **From material**. For **User defined** select **Isotropic**, **Diagonal**, **Symmetric**, or **Full** based on the characteristics of the magnetic field, and then enter values or expressions in the field or matrix. Then enter coordinates for the **Remanent flux density**  $\mathbf{B}_r$  (SI unit: T).

#### *Magnetization*

For **Magnetization** enter coordinates for  $\mathbf{M}$  (SI unit: A/m).

#### *B-H Curve*

Select **B-H curve**  $|\mathbf{B}|$  (SI unit: T) to use a curve that relates magnetic field  $\mathbf{H}$  and the magnetic flux density  $\mathbf{B}$  as  $|\mathbf{B}| = f(|\mathbf{H}|) \mathbf{H} / |\mathbf{H}|$ . The **Magnetic field norm** setting can take the values **From material** or **User defined**.

Material properties from [Nonlinear Magnetic Materials Library](#) can be used for **B-H curve** that are generally provided as interpolation functions for the magnetization curve without hysteresis effects.



Nonlinear simulations with the **B-H curve** magnetic field constitutive relation may require customized time-stepping settings in the **Time-Dependent Solver** for stability. The **BDF** method, with constant maximum step constraint, user-defined maximum step, and low maximum BDF order such as 2, would provide better convergence.

## CONDUCTION CURRENT

This section is available if **Relative permittivity**, **Polarization**, or **Remanent electric displacement** are chosen as the **Electric displacement field model**.

By default, the **Electrical conductivity**  $\sigma$  (SI unit: S/m) uses values **From material**.

- For **User defined** select **Isotropic**, **Diagonal**, **Symmetric**, or **Full** based on the characteristics of the current and enter values or expressions in the field or matrix.
- For **Linearized resistivity** the default values for the **Reference temperature**  $T_{\text{ref}}$  (SI unit: K), **Resistivity temperature coefficient**  $\alpha$  (SI unit: 1/K), and **Reference resistivity**  $\rho_0$  (SI unit:  $\Omega\text{m}$ ) use values **From material**. For **User defined** enter other values or expressions for any of these variables.
- If **Effective medium** is selected, the **Effective medium** subnode is available from the context menu (right-click the parent node) or from the **Physics** toolbar, **Attributes** menu.
- If **Archie's Law** is selected, the **Archie's Law** subnode is available from the context menu (right-click the parent node) or from the **Physics** toolbar, **Attributes** menu.

## *Initial Values*

The **Initial Values** node adds an initial value for the magnetic vector potential and its time derivative that serves as initial conditions for the transient simulation.

## INITIAL VALUES

Enter values or expressions for the initial values of the components of the magnetic vector potential  $\mathbf{A}$  (SI unit: Wb/m) and its time derivative  $\partial\mathbf{A}/\partial t$  (SI unit: V/m). The default values are 0 Wb/m and 0 V/m, respectively.

## Drude–Lorentz Polarization

---

This subfeature is available only when **Drude-Lorentz Dispersion Model** is selected as the **Electric displacement field model** in the **Wave Equation, Electric** feature node. Then the subnodes are made available from the context menu (right-click the parent node) as well as from the **Physics** toolbar, **Attributes** menu.

Each **Drude-Lorentz Polarization** subnode adds another polarization term  $\mathbf{P}_n$  to the electric displacement field  $\mathbf{D}$ , defined by

$$\mathbf{D} = \varepsilon_0 \varepsilon_\infty \mathbf{E} + \sum_{n=1}^N \mathbf{P}_n,$$

where the polarization is the solution to the ordinary differential equation

$$\left( \frac{\partial^2}{\partial t^2} + \Gamma_n \frac{\partial}{\partial t} + \omega_n^2 \right) \mathbf{P}_n = \varepsilon_0 f_n \omega_p^2 \mathbf{E}.$$

Here  $\Gamma_n$  is a damping coefficient,  $\omega_n$  is a resonance frequency,  $f_n$  is an oscillator strength, and  $\omega_p$  is the plasma frequency.

Enter values or expressions for the **Oscillator strength**  $f_n$  (SI unit: 1), the **Resonance frequency**  $\omega_n$  (SI unit: rad/s), and the **Damping in time** coefficient  $\Gamma_n$  (SI unit: rad/s).

### INITIAL VALUES

Enter values or expressions for the initial values of the components of the Drude–Lorentz polarization  $\mathbf{P}_n$  (SI unit: C/m<sup>2</sup>) and its time derivative  $\partial \mathbf{P}_n / \partial t$  (SI unit: A/m<sup>2</sup>).

### DISCRETIZATION

To display this section, click the **Show More Options** button (  ) and select **Discretization** from the **Show More Options** dialog box. Select the element order from the list box for the Drude-Lorentz polarization  $\mathbf{P}_n$ .





*Time-Domain Modeling of Dispersive Drude–Lorentz Media:*  
Application Library path **RF\_Module/Tutorials/drude\_lorentz\_media**

---



# The Transmission Line Interface

The **Transmission Line (tl)** interface ()<sup>1</sup>, found under the **Radio Frequency** branch () when adding a physics interface, is used to study propagation of waves along one-dimensional transmission lines. The physics interface solves the time-harmonic transmission line equation for the electric potential.

The physics interface is used when solving for electromagnetic wave propagation along one-dimensional transmission lines and is available in 1D, 2D, and 3D. The physics interface has Eigenfrequency and Frequency Domain study types available. The Frequency Domain study is used for source driven simulations for a single frequency or a sequence of frequencies.

When this physics interface is added, these default nodes are also added to the **Model Builder** — **Transmission Line Equation**, **Absorbing Boundary**, and **Initial Values**. Then, from the **Physics** toolbar, add other nodes that implement, for example, boundary conditions. You can also right-click **Transmission Line** to select physics features from the context menu.

## SETTINGS

The **Label** is the default physics interface name.

The **Name** is used primarily as a scope prefix for variables defined by the physics interface. Refer to such physics interface variables in expressions using the pattern `<name>.<variable_name>`. In order to distinguish between variables belonging to different physics interfaces, the `name` string must be unique. Only letters, numbers, and underscores (`_`) are permitted in the **Name** field. The first character must be a letter.

The default **Name** (for the first physics interface in the model) is `tl`.

## PORT SWEEP SETTINGS

Select the **Activate port sweep** check box to switch on the port sweep. When selected, this invokes a parametric sweep over the lumped ports in addition to the automatically generated frequency sweep. The generated lumped parameters are in the form of an S-parameter matrix. For **Activate port sweep** enter a **Sweep parameter name** (the default is `PortName`) to assign a specific name to the variable that controls the port number solved for during the sweep.

For this physics interface, the S-parameters are subject to **Touchstone file export**. Click **Browse** to locate the file, or enter a file name and path. Select an **Output format** — **Magnitude angle**, **Magnitude (dB) angle**, or **Real imaginary**.

#### DEPENDENT VARIABLES

The dependent variable (field variable) is the **Electric potential V** (SI unit: V). The name can be changed but the names of fields and dependent variables must be unique within a model.

#### DISCRETIZATION

Select the shape order for the **Electric potential** dependent variable — **Linear**, **Quadratic** (the default), or **Cubic**. For more information about the **Discretization** section, see [Settings for the Discretization Sections](#) in the *COMSOL Multiphysics Reference Manual*.



- [Domain, Boundary, Edge, Point, and Pair Nodes for the Transmission Line Equation Interface](#)
- [Theory for the Transmission Line Interface](#)
- [Visualization and Selection Tools](#) in the *COMSOL Multiphysics Reference Manual*



*Quarter-Wave Transformer*: Application Library path **RF\_Module/Transmission\_Lines\_and\_Waveguides/quarter\_wave\_transformer**

---

#### *Domain, Boundary, Edge, Point, and Pair Nodes for the Transmission Line Equation Interface*

The [Transmission Line Interface](#) has these domain, boundary, edge, point, and pair nodes available from the **Physics** ribbon toolbar (Windows users), **Physics** context menu (Mac or Linux users), or right-click to access the context menu (all users).



In general, to add a node, go to the **Physics** toolbar, no matter what operating system you are using. Subnodes are available by clicking the parent node and selecting it from the **Attributes** menu.

---



Select **Edges** for 3D models, **Boundaries** for 2D models, and **Domains** for 1D models. **Points** are available for all space dimensions (3D, 2D, and 1D).

For all space dimensions, select **Points** for the boundary condition.

- Absorbing Boundary
- Incoming Wave
- Initial Values
- Open Circuit
- Terminating Impedance
- Transmission Line Equation
- Short Circuit
- Lumped Port



## Theory for the Transmission Line Boundary Conditions

### *Transmission Line Equation*

The **Transmission Line Equation** node is the main feature of the Transmission Line interface. It defines the 1D wave equation for the electric potential. The wave equation is written in the form

$$\frac{\partial}{\partial x} \left( \frac{1}{R + i\omega L} \frac{\partial V}{\partial x} \right) - (G + i\omega C)V = 0$$

where  $R$ ,  $L$ ,  $G$ , and  $C$  are the distributed resistance, inductance, conductance, and capacitance, respectively.

#### **TRANSMISSION LINE EQUATION**

Enter the values for the following:

- **Distributed resistance**  $R$  (SI unit:  $\text{m}\cdot\text{kg}/(\text{s}^3\cdot\text{A}^2)$ ). The default is  $0 \text{ m}\cdot\text{kg}/(\text{s}^3\cdot\text{A}^2)$ .
- **Distributed inductance**  $L$  (SI unit:  $\text{H}/\text{m}$ ). The default is  $2.5\text{e-}6 \text{ H}/\text{m}$ .
- **Distributed conductance**  $G$  (SI unit:  $\text{S}/\text{m}$ ). The default is  $0 \text{ S}/\text{m}$ .
- **Distributed capacitance**  $C$  (SI unit:  $\text{F}/\text{m}$ ). The default is  $1\text{e-}9 \text{ F}/\text{m}$ .

The default values give a characteristic impedance for the transmission line of  $50 \Omega$ .

### *Initial Values*

---

The **Initial Values** node adds an initial value for the electric potential that can serve as an initial guess for a nonlinear solver.

#### **INITIAL VALUES**

Enter values or expressions for the initial values of the **Electric potential**  $V$  (SI unit: V).

### *Absorbing Boundary*

---

The **Absorbing Boundary** condition is stated as

$$\frac{\mathbf{n} \cdot \nabla V}{R + j\omega L} + \frac{V}{Z_0} = 0$$

where  $\gamma$  is the complex propagation constant defined by

$$\gamma = \sqrt{(R + i\omega L)(G + i\omega C)}$$

and  $\mathbf{n}$  is the normal pointing out of the domain. The *absorbing boundary* condition prescribes that propagating waves are absorbed at the boundary and, thus, that there is no reflection at the boundary. The Absorbing Boundary condition is only available on external boundaries.



[Theory for the Transmission Line Boundary Conditions](#)

---

### *Incoming Wave*

---

The **Incoming Wave** boundary condition

$$\frac{\mathbf{n} \cdot \nabla V}{R + j\omega L} + \frac{V - 2V_0}{Z_0} = 0$$

lets a wave of complex amplitude  $V_{in}$  enter the domain. The complex propagation constant  $\gamma$  and the outward-pointing normal  $\mathbf{n}$  are defined in the section describing the [Absorbing Boundary](#) node. The Incoming Wave boundary condition is only available on external boundaries.

## VOLTAGE

Enter the value or expression for the input **Electric potential**  $V_0$  (SI unit: V). The default is 1 V.



### Theory for the Transmission Line Boundary Conditions

#### *Open Circuit*

The **Open Circuit** boundary condition is a special case of the [Terminating Impedance](#) boundary condition, assuming an infinite impedance, and, thus, zero current at the boundary. The condition is thus

$$\mathbf{n} \cdot \nabla V = 0$$

The Open Circuit boundary condition is only available on external boundaries.



### Theory for the Transmission Line Boundary Conditions

#### *Terminating Impedance*

The **Terminating Impedance** boundary condition

$$\frac{\mathbf{n} \cdot \nabla V}{R + j\omega L} + \frac{V}{Z_L} = 0$$

specifies the terminating impedance to be  $Z_L$ . Notice that the [Absorbing Boundary](#) condition is a special case of this boundary condition for the case when

$$Z_L = Z_0 = \sqrt{\frac{R + j\omega L}{G + j\omega C}}$$

The [Open Circuit](#) and [Short Circuit](#) boundary conditions are also special cases of this condition. The Terminating Impedance boundary condition is only available on external boundaries.

## IMPEDANCE

Enter the value or expression for the **Impedance**  $Z_L$  (SI unit:  $\Omega$ ). The default is 50  $\Omega$ .



Theory for the Transmission Line Boundary Conditions

---

### *Short Circuit*

---

The **Short Circuit** node is a special case of the **Terminating Impedance** boundary condition, assuming that impedance is zero and, thus, the electric potential is zero. The constraint at this boundary is, thus,  $V = 0$ .

## CONSTRAINT SETTINGS

To display this section, click the **Show More Options** button (  ) and select **Advanced Physics Options** in the **Show More Options** dialog box.



Theory for the Transmission Line Boundary Conditions

---

### *Lumped Port*

---

Use the **Lumped Port** node to apply a voltage or current excitation of a model or to connect to a circuit. The **Lumped Port** node also defines S-parameters (reflection and transmission coefficients) that can be used in later postprocessing steps.

## PORT PROPERTIES

Enter a unique **Port Name**. It is recommended to use a numeric name as it is used to define the elements of the S-parameter matrix and numeric port names are also required for port sweeps and Touchstone file export.

Select a **Type of Port** — **Cable** (the default), **Current**, or **Circuit**.

## SETTINGS



If a **Circuit** port type is selected under **Port Properties**, this section does not require any selection.

---

- If a **Cable** port type is selected under **Port Properties**, enter the **Characteristic impedance**  $Z_{\text{ref}}$  (SI unit:  $\Omega$ ). The default is 50  $\Omega$ .
- If a **Current** terminal type is selected under **Port Properties**, enter a **Terminal current**  $I_0$  (SI unit: A). The default is 1 A.



If **Cable** is selected as the port type, select the **Wave excitation at this port** check box to enter values or expressions for the:

- **Electric potential**  $V_0$  (SI unit: V). The default is 1 V.
- **Port phase**  $\theta_{\text{in}}$  (SI unit: rad). The default is 0 radians.



- [S-Parameters and Ports](#)
  - [Lumped Ports with Voltage Input](#)
  - [Theory for the Transmission Line Boundary Conditions](#)
-

# The Electromagnetic Waves, Time Explicit Interface

The **Electromagnetic Waves, Time Explicit (ewte)** interface () , found under the **Radio Frequency** branch () when adding a physics interface, is used to model time-dependent electromagnetic wave propagation in linear media. The sources can be in the form of volumetric electric or magnetic currents, or electric surface currents or fields on boundaries.

This physics interface solves two first-order partial differential equations (Faraday's law and Maxwell–Ampère's law) for the electric and magnetic fields using the time explicit discontinuous Galerkin method.

When this physics interface is added, these default nodes are also added to the **Model Builder** — **Wave Equations**, **Perfect Electric Conductor**, and **Initial Values**. Then, from the **Physics** toolbar, add other nodes that implement, for example, boundary conditions. You can also right-click **Electromagnetic Waves, Time Explicit** to select physics features from the context menu.

The interface includes absorbing layers that are used to set up effective nonreflecting like boundary conditions. These features are added from the **Definitions** toolbar, by clicking **Absorbing Layer**. If COMSOL Multiphysics is not running in full-screen mode nor in a large window, **Absorbing Layer** is accessible on the **Definitions** toolbar by first clicking **Coordinate Systems** and then **Absorbing Layer**. You can also right-click **Definitions** in the **Model Builder** and select **Absorbing Layer** from the context menu.

## SETTINGS

The **Label** is the default physics interface name.

The **Name** is used primarily as a scope prefix for variables defined by the physics interface. Refer to such physics interface variables in expressions using the pattern `<name>.<variable_name>`. In order to distinguish between variables belonging to different physics interfaces, the `name` string must be unique. Only letters, numbers, and underscores (`_`) are permitted in the **Name** field. The first character must be a letter.

The default **Name** (for the first physics interface in the model) is `ewte`.

## COMPONENTS

This section is available for 2D and 2D axisymmetric components.



Select the **Field components solved for**:

- **Full wave** (the default) to solve using a full three-component vector for the electric field **E** and the magnetic field **H**.
- **E in plane (TM wave)** to solve for the electric field vector components in the modeling plane and one magnetic field vector component perpendicular to the plane, assuming that there is no electric field perpendicular to the plane and no magnetic field components in the plane.
- **H in plane (TE wave)** to solve for the magnetic field vector components in the modeling plane and one electric field vector component perpendicular to the plane.

#### DEPENDENT VARIABLES

The dependent variables (field variables) are for the **Electric field vector E** and for the **Magnetic field vector H**. The name can be changed but the names of fields and dependent variables must be unique within a model.

#### DISCRETIZATION

Select the shape order for the **Electric and magnetic fields** dependent variables (the same order for both fields) — **Linear**, **Quadratic**, or **Cubic** (the default). For more information about the **Discretization** section, see [Settings for the Discretization Sections](#) in the *COMSOL Multiphysics Reference Manual*.



- [Domain, Boundary, and Pair Nodes for the Electromagnetic Waves, Time Explicit Interface](#)
  - [Theory for the Electromagnetic Waves, Time Explicit Interface](#)
- 

#### *Domain, Boundary, and Pair Nodes for the Electromagnetic Waves, Time Explicit Interface*

---

The [Electromagnetic Waves, Time Explicit Interface](#) has these domain and boundary nodes, listed in alphabetical order, available from the **Physics** ribbon toolbar (Windows users), **Physics** context menu (Mac or Linux users), or right-click to access the context menu (all users).



In general, to add a node, go to the **Physics** toolbar, no matter what operating system you are using. Subnodes are available by clicking the parent node and selecting it from the **Attributes** menu.

---



In the *COMSOL Multiphysics Reference Manual* see [Table 2-4](#) for links to common sections and [Table 2-5](#) to common feature nodes. You can also search for information: press F1 to open the **Help** window or Ctrl+F1 to open the **Documentation** window.



For axisymmetric components, COMSOL Multiphysics takes the axial symmetry boundaries (at  $r = 0$ ) into account and automatically adds an **Axial Symmetry** node to the component that is valid on the axial symmetry boundaries only.

- Background Field
- Electric Field
- Electric Current Density
- Far-Field Calculation
- Far-Field Domain
- Flux/Source
- Initial Values
- Lumped Port
- Magnetic Current Density
- Magnetic Field
- Perfect Electric Conductor
- Perfect Magnetic Conductor
- Scattering Boundary Condition
- Surface Current Density
- Wave Equations

### Wave Equations

The **Wave Equations** node is the main node for the Electromagnetic Waves, Time Explicit interface. The governing transient equations can be written in the form

$$\begin{aligned}\nabla \times \mathbf{H} &= \sigma \mathbf{E} + \frac{\partial \mathbf{D}}{\partial t} \\ \nabla \times \mathbf{E} &= -\frac{\partial \mathbf{B}}{\partial t}\end{aligned}$$

with the constitutive relations  $\mathbf{B} = \mu_0 \mu_r \mathbf{H}$  and  $\mathbf{D} = \epsilon_0 \epsilon_r \mathbf{E}$ , which reads

$$\begin{aligned}\epsilon_0 \epsilon_r \frac{\partial \mathbf{E}}{\partial t} - \nabla \times \mathbf{H} + \sigma \mathbf{E} &= 0 \\ \mu_0 \mu_r \frac{\partial \mathbf{H}}{\partial t} + \nabla \times \mathbf{E} &= 0\end{aligned}$$

## MATERIAL PROPERTIES

The default **Relative permittivity**  $\epsilon_r$  (dimensionless), **Relative permeability**  $\mu_r$  (dimensionless), and **Electrical conductivity**  $\sigma$  (SI unit: S/m) take values **From material**. For **User defined** select **Isotropic**, **Diagonal**, **Symmetric**, or **Full** and enter values or expressions in the field or matrix.

## NUMERICAL PARAMETERS

- Enter a value or an expression for **Estimate of maximum wave speed**  $c_{\max}$  (SI unit: m/s), the default is taken from the speed of light in a vacuum  $c_{\text{const}}$ .

Select the **Flux type** — **Lax-Friedrichs** or **Upwind flux**.

### *Lax-Friedrichs*

- Enter an expression for **Lax-Friedrichs flux parameter for E field**  $\tau_E$  (SI unit: S), the default is  $0.5/Z$  for Ampere's law.
- Enter an expression for **Lax-Friedrichs flux parameter for H field**  $\tau_H$  (SI unit:  $\Omega$ ), the default is  $0.5 Z$  for Faraday's law, where  $Z$  is the impedance of vacuum.

### *Upwind flux*

Enter a **Scaling factor**  $\alpha_{\text{upwind}}$ , the default is 1 (dimensionless). When it is set to 0, the flux type becomes the central flux.

## FILTER PARAMETERS

The filter provides higher-order smoothing of nodal discontinuous Galerkin formulations and is intended to be used for absorbing layers, but you can also use it to stabilize linear wave problems with highly varying coefficients. The filter is constructed by transforming the solution (in each global time step) to an orthogonal polynomial representation, multiplying with a damping factor and then transforming back to the (Lagrange) nodal basis. Select the **Activate** check box to use this filter.

The exponential filter can be described by the matrix formula

$$V \Lambda V^{-1}$$

where  $V$  is a Vandermonde matrix induced by the node points, and  $\Lambda$  is a diagonal matrix with the exponential damping factors on the diagonal:

$$\Lambda_{mm} = \sigma(\eta) = \begin{cases} 1, & 0 \leq \eta \leq \eta_c \\ e^{-\alpha \left( \frac{\eta - \eta_c}{1 - \eta_c} \right)^{2s}}, & \eta_c \leq \eta \leq 1 \end{cases}$$

where

$$\eta = \eta(m) = \frac{i_m}{N_p}$$

and  $N_p$  is the basis function and  $i_m$  the polynomial order for coefficient  $m$ .  $\alpha$  (default value: 36),  $\eta_c$  (default value: 1), and  $s$  (default value: 3) are the filter parameters that you specify in the corresponding text fields. The damping is derived from a spatial dissipation operator of order  $2s$ . For  $s = 1$ , you obtain a damping that is related to the classical 2nd-order Laplacian. Higher order (larger  $s$ ) gives less damping for the lower-order polynomial coefficients (a more pronounced low-pass filter), while keeping the damping property for the highest values of  $\eta$ , which is controlled by  $\alpha$ . The default values 36 for  $\alpha$  correspond to maximal damping for  $\eta = 1$ . It is important to realize that the effect of the filter is influenced by how much of the solution (energy) is represented by the higher-order polynomial coefficients. For a well resolved solution this is a smaller part than for a poorly resolved solution. The effect is stronger for poorly resolved solutions than for well resolved ones. This is one of the reasons why this filter is useful in an absorbing layer where the energy is transferred to the higher-order coefficients through a coordinate transformation. See [Ref. 1](#) (Chapter 5) for more information.

$\alpha$  must be positive;  $\alpha = 0$  means no dissipation, and the maximum value is related to the machine precision,  $-\log(\varepsilon)$ , which is approximately 36.  $\eta_c$  should be between 0 and 1, where  $\eta_c = 0$  means maximum filtering, and  $\eta_c = 1$  means no filtering, even if filtering is active.

When using **Absorbing Layer** features, add an additional **Wave Equations** feature for the corresponding domain selection. Select the **Activate** check box and add filter parameters. An example of a filter parameter combination that can be used for a **Wave Equations** feature active on an **Absorbing Layer** domain selection is  $\alpha = 0.1$ ,  $\eta_c = 0.01$ ,

and  $s = 2$ . However, other combinations could work better, depending on the particular application.



## Absorbing Layers

---

### Reference

1. J.S. Hesthaven and T. Warburton, *Nodal Discontinuous Galerkin Methods — Algorithms, Analysis, and Applications*, Springer, 2008.

### Initial Values

---

The **Initial Values** node adds the initial values for the **Electric field** and **Magnetic field** variables that serve as an initial condition for the transient simulation.

### DOMAIN SELECTION

If there is more than one type of domain, each with different initial values defined, it might be necessary to remove these domains from the selection. These are then defined in an additional **Initial Values** node.

### INITIAL VALUES

Enter values or expressions for the initial values of the components of the **Electric field**  $\mathbf{E}$  (SI unit: V/m) and **Magnetic field**  $\mathbf{H}$  (SI unit: A/m). The default values are 0 for all vector components.

### Electric Current Density

---

The **Electric Current Density** node adds an external current density to the specified domains, which appears on the right-hand side of Ampere's law

$$\epsilon_0 \epsilon_r \frac{\partial \mathbf{E}}{\partial t} - \nabla \times \mathbf{H} + \sigma \mathbf{E} = -\mathbf{J}_e$$

### ELECTRIC CURRENT DENSITY

Based on space dimension, enter the coordinates ( $\mathbf{x}$ ,  $\mathbf{y}$ , and  $\mathbf{z}$  for 3D components for example) of the **Electric current density**  $\mathbf{J}_e$  (SI unit: A/m<sup>2</sup>).

### *Magnetic Current Density*

---

The **Magnetic Current Density** node adds an external current density to the specified domains, which appears on the right-hand side of Faraday's law

$$\mu_0\mu_r \frac{\partial \mathbf{H}}{\partial t} + \nabla \times \mathbf{E} = -\mathbf{J}_m$$

#### **MAGNETIC CURRENT DENSITY**

Based on space dimension, enter the coordinates (**x**, **y**, and **z** for 3D components for example) of the **Magnetic current density**  $\mathbf{J}_m$  (SI unit: V/m<sup>2</sup>).

### *Electric Field*

---

The **Electric Field** boundary condition

$$\mathbf{n} \times \mathbf{E} = \mathbf{n} \times \mathbf{E}_0$$

specifies the tangential component of the electric field. The commonly used special case of zero tangential electric field (perfect electric conductor) is described in the next section.

#### **ELECTRIC FIELD**

Enter values or expressions for the components of the **Electric field**  $\mathbf{E}_0$  (SI unit: V/m).

### *Perfect Electric Conductor*

---

The **Perfect Electric Conductor** boundary condition

$$\mathbf{n} \times \mathbf{E} = \mathbf{0}$$

is a special case of the electric field boundary condition that sets the tangential component of the electric field to zero. It is used for the modeling of a lossless metallic surface, for example, a ground plane or as a symmetry type boundary condition.

It imposes symmetry for magnetic fields and antisymmetry for electric fields and electric currents. It supports induced electric surface currents and thus any prescribed or induced electric currents (volume, surface, or edge currents) flowing into a perfect electric conductor boundary is automatically balanced by induced surface currents.

## *Magnetic Field*

---

The **Magnetic Field** node adds a boundary condition for specifying the tangential component of the magnetic field at the boundary:

$$\mathbf{n} \times \mathbf{H} = \mathbf{n} \times \mathbf{H}_0$$

### **MAGNETIC FIELD**

Enter values or expressions for the components of the **Magnetic field**  $\mathbf{H}_0$  (SI unit: A/m).

## *Perfect Magnetic Conductor*

---

The **Perfect Magnetic Conductor** boundary condition

$$\mathbf{n} \times \mathbf{H} = \mathbf{0}$$

is a special case of the surface current density boundary condition that sets the tangential component of the magnetic field and thus also the surface current density to zero. On external boundaries, this can be interpreted as a “high surface impedance” boundary condition or used as a symmetry type boundary condition. It imposes symmetry for electric fields and electric currents. Electric currents (volume, surface, or edge currents) are not allowed to flow into a perfect magnetic conductor boundary as that would violate current conservation. On interior boundaries, the perfect magnetic conductor boundary condition literally sets the tangential magnetic field to zero which in addition to setting the surface current density to zero also makes the tangential electric field discontinuous.

## *Surface Current Density*

---

The **Surface Current Density** boundary condition

$$\begin{aligned} -\mathbf{n} \times \mathbf{H} &= \mathbf{J}_s \\ \mathbf{n} \times (\mathbf{H}_1 - \mathbf{H}_2) &= \mathbf{J}_s \end{aligned}$$

specifies a surface current density at both exterior and interior boundaries. The current density is specified as a three-dimensional vector, but because it needs to flow along the boundary surface, COMSOL Multiphysics projects it onto the boundary surface and neglects its normal component. This makes it easier to specify the current density

and avoids unexpected results when a current density with a component normal to the surface is given.

#### **SURFACE CURRENT DENSITY**

Enter values or expressions for the components of the **Surface current density**  $\mathbf{J}_{s0}$  (SI unit: A/m). The defaults are 0 A/m for all vector components.

#### *Scattering Boundary Condition*

---

The **Scattering Boundary Condition**

$$\mathbf{n} \times \mathbf{E} = Z_0 \mathbf{H}$$

specifies the tangential component of both electric and magnetic fields.

#### **SCATTERING BOUNDARY CONDITION**

Enter the expressions for the components for the **Incident electric field**  $\mathbf{E}_0$  (SI unit: V/m), if there is an incoming wave from the boundary.

Enter the value or expression for the medium **Impedance**  $Z_0$  (SI unit:  $\Omega$ ). By default, the  $Z_0$  uses the value of the vacuum's impedance. Then select **Isotropic**, **Diagonal**, **Symmetric**, or **Full** based on the material characteristics and enter values or expressions in the field or matrix.

#### *Flux/Source*

---

The **Flux/Source** boundary condition

$$\mathbf{n} \times \mathbf{E} = \mathbf{E}_0$$

$$\mathbf{n} \times \mathbf{H} = \mathbf{H}_0$$

specifies the tangential component of both electric and magnetic fields. This boundary condition is available when **Advanced Physics Options** is selected in the **Show More Options** dialog box on the **Model Builder** toolbar.

#### **BOUNDARY FLUX/SOURCE**

Enter values or expressions for the components of the tangential **Electric field**  $\mathbf{E}_0$  (SI unit: V/m) and the tangential **Magnetic field**  $\mathbf{H}_0$  (SI unit: A/m).



## Background Field

---

The **Background Field** feature triggers the scattered field formulation, where the dependent variable is the relative field. The same wave equations are used as in the full field formulation, but the total field that enters the equations are written as the sum of the relative field and the background field,  $\mathbf{E} = \mathbf{E}_{\text{relative}} + \mathbf{E}_{\text{background}}$ , and it is the dependent variable  $\mathbf{E}_{\text{relative}}$  that is solved for. When the background field is a solution of the wave equation, the relative field is the scattered field.

### SETTINGS

Select a **Background wave type** — **User defined** (the default), or **Modulated Gaussian pulse**.

#### User Defined

Enter the component expressions for the **Background electric field**  $\mathbf{E}_b$  (SI unit: V/m) and **Background magnetic field**  $\mathbf{H}_b$  (SI unit: A/m). The entered expressions must be differentiable in time domain since the derivative of the background field is used in the governing equations.

#### Modulated Gaussian pulse

Select a **Direction of propagation** — **+x** (the default), **-x**, **+y**, **-y**, or for 3D components, **Along the +z** or **-z**.

Select a **Polarization direction** — **y** (the default), **z**, or **x**. The list of available polarization varies based on the selection of **Direction of propagation**.

- Enter a **Center frequency**  $f_0$  (SI unit: Hz). The default is 1 GHz.
- Enter a **Phase velocity**  $v_p$  (SI unit: m/s). The default is  $c_{\text{const}}$ .
- Enter a **Wave impedance**  $Z$  (SI unit:  $\Omega$ ). The default is  $Z0_{\text{const}}$ .
- Enter a **Distance from origin to wave launching plane**  $d_{\text{offset}}$  (SI unit: m). The default is 0 m.

For a modulated Gaussian pulse propagating in the positive  $x$  direction, the electric field is expressed as

$$E(x, t) = \frac{1}{\tau\sqrt{2\pi}} \exp\left(-\frac{\left(t - \mu - \frac{x + d_{\text{offset}}}{v_p}\right)^2}{2\tau^2}\right) \sin\left(2\pi f_0\left(t - \frac{x}{v_p}\right)\right)$$

where  $\tau$  is the pulse duration, defined as  $1/2f_0$ ,  $\mu$  is a time delay set to  $2/f_0$ , and  $v_p$  is the phase velocity. The time delay  $\mu$  is used to excite a modulated Gaussian pulse whose initial magnitude is very small when it is launched and gradually increases as it propagates.



*Wideband RCS Calculation Using Time-Domain Simulation and FFT:* Application Library path **RF\_Module/Scattering\_and\_RCS/rcs\_time\_explicit** demonstrates how to set up a background field.

### *Far-Field Domain*

To set up a far-field calculation, add a **Far-Field Domain** node and specify the far-field domains in its Settings window. Use Far-Field Calculation subnodes (one is added by default) to specify all other settings needed to define the far-field calculation. By default, all of the domains are selected. The selection can be modified. In that case, select only a homogeneous domain or domain group that is outside of all radiating and scattering objects and which has the material settings of the far-field medium.

### *Far-Field Calculation*

A **Far-Field Calculation** subnode is added by default to the **Far-Field Domain** node and is used to select boundaries corresponding to a single closed surface surrounding all radiating and scattering objects. By default, all exterior boundaries of the **Far-Field Domain** are selected. Symmetry reduction of the geometry makes it relevant to select boundaries defining a nonclosed surface. Also use this feature to indicate symmetry planes and symmetry cuts applied to the geometry, and whether the selected boundaries are defining the inside or outside of the far field domain; that is, to say whether they are facing away from infinity or toward infinity.

#### **FAR-FIELD CALCULATION**

Enter a **Far-field variable name**. The default is  $E_{far}$ .

Select as needed the **Symmetry in the x=0 plane**, **Symmetry in the y=0 plane**, or **Symmetry in the z=0 plane** check boxes to use in your model when calculating the far-field variable. The symmetry planes have to coincide with one of the Cartesian coordinate planes.

When a check box is selected, also choose the type of symmetry to use from the **Symmetry type** list that appears — **Symmetry in E (PMC)** or **Symmetry in H (PEC)**. The

selection should match the boundary condition used for the symmetry boundary. Using these settings, include the parts of the geometry that are not in the model for symmetry reasons in the far-field analysis.



From the **Boundary relative to domain** list, select **Inside** or **Outside** (the default) to define if the selected boundaries are defining the inside or outside of the far-field domain (that is, whether facing away from infinity or toward infinity).



A **Time to Frequency FFT** study step must be added after the **Time Dependent** study step to generate the necessary frequency-domain data, used in the far-field analysis.

---

# The Electromagnetic Waves, Asymptotic Scattering Interface

The **Electromagnetic Waves, Asymptotic Scattering (ewas)** interface (  ), found under the **Radio Frequency** branch (  ) when adding a physics interface, is used for quick studies of the far-field response of a 3D or 2D object to a given background field. The physics interface sets up a surface electric background field for the far-field transformation, using the Stratton–Chu formula, performed in the postprocessing.

Use this physics interface in 2D and 3D when approximating the scattered far-field of an object configured only by a perfect electric conductor boundary condition. The physics interface supports the Frequency Domain study type. The Frequency Domain study can also be used for sweeping the background field by a sequence of frequencies.

When this physics interface is added, these default nodes are also added to the **Model Builder: Asymptotic Scattering, Far-Field Calculation**, and **Initial Values**. No additional boundary feature is needed in general. However, from the **Physics** toolbar, a new **Far-Field Calculation** can be added to process the far-field calculation on user-defined boundary selections. You can also right-click **Electromagnetic Waves, Asymptotic Scattering** to select physics features from the context menu.

## SETTINGS

The **Label** is the default physics interface name.

The **Name** is used primarily as a scope prefix for variables defined by the physics interface. Refer to such physics interface variables in expressions using the pattern `<name>.<variable_name>`. In order to distinguish between variables belonging to different physics interfaces, the `name` string must be unique. Only letters, numbers, and underscores (`_`) are permitted in the **Name** field. The first character must be a letter.

The default **Name** (for the first physics interface in the model) is `ewas`.

### *Physics-Controlled Mesh*

The physics-controlled mesh is controlled from the **Mesh** node's **Settings** window (if the **Sequence type** is **Physics-controlled mesh**). In the table in the **Physics-Controlled Mesh** section, find the physics interface in the **Contributor** column and select or clear the check box in the **Use** column on the same row for enabling (the default) or disabling contributions from the physics interface to the physics-controlled mesh.

When the **Use** check box for the physics interface is selected, this invokes a parameter for the maximum mesh element size in free space. The physics-controlled mesh automatically scales the maximum mesh element size as the wavelength changes.

When the **Use** check box is selected for the physics interface in the section for the physics interface below the table, choose one of the four options for the **Maximum mesh element size control parameter** — **From study** (the default), **User defined**, **Frequency**, or **Wavelength**. When **From study** is selected, 1/5 of the vacuum wavelength from the highest frequency defined in study step is used for the maximum mesh element size. For the option **User defined**, enter a suitable **Maximum element size in free space**. For example, 1/5 of the vacuum wavelength or smaller. When **Frequency** is selected, enter the highest frequency intended to be used during the simulation. The maximum mesh element size in free space is 1/5 of the vacuum wavelength for the entered frequency. For the **Wavelength** option, enter the smallest vacuum wavelength intended to be used during the simulation. The maximum mesh element size in free space is 1/5 of the entered wavelength.

#### FORMULATION

For **Scattered field** select a **Background wave type** according to the following table:

TABLE 4-2: BACKGROUND WAVE TYPE BASED ON COMPONENT DIMENSION

COMPONENT	BACKGROUND WAVE TYPE
2D	User defined (default)
3D	User defined (default), Linearly polarized plane wave

#### *User Defined*

Enter the component expressions for the **Background electric field**  $\mathbf{E}_b$  (SI unit: V/m). The entered expressions must be differentiable.



Notice that expressions including coupling operators are not differentiable and cannot be used as background fields.

#### *Linearly Polarized Plane Wave*

The initial background wave is predefined as  $\mathbf{E}_0 = \exp(-jk_x x)\mathbf{z}$ . This field is transformed by three successive rotations along the roll, pitch, and yaw angles, in that order. For a graphic representation of the initial background field and the definition of the three rotations; compare with [Figure 4-1](#) below.

- Enter an **Electric field amplitude**  $E_0$  (SI unit: V/m). The default is 1 V/m.

- Enter a **Roll angle** (SI unit: rad), which is a right-handed rotation with respect to the  $+x$  direction. The default is 0 rad, corresponding to polarization along the  $+z$  direction.
- Enter a **Pitch angle** (SI unit: rad), which is a right-handed rotation with respect to the  $+y$  direction. The default is 0 rad, corresponding to the initial direction of propagation pointing in the  $+x$  direction.
- Enter a **Yaw angle** (SI unit: rad), which is a right-handed rotation with respect to the  $+z$  direction.
- Enter a **Wave number  $k$**  (SI unit: rad/m). The default is  $\epsilon_{\text{was}} k_0$  rad/m. The wave number must evaluate to a value that is the same for the domains the scattered field is applied to.

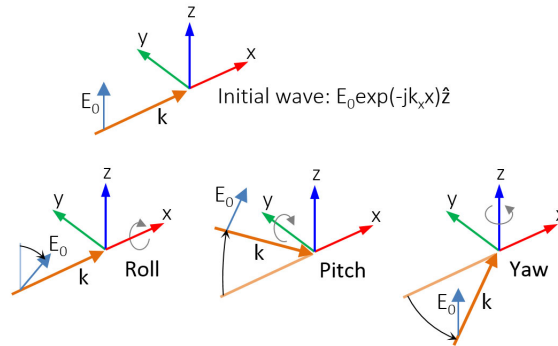

Figure 4-7: Schematic of the directions for the wave vector  $\mathbf{k}$ , the electric field  $\mathbf{E}_0$ , and the roll, pitch and yaw rotations. The top image represents an initial wave propagating in the  $x$  direction with a polarization along the  $z$  direction.

#### DEPENDENT VARIABLES

The dependent variables (field variables) are for the **Electric field  $\mathbf{E}$**  and its components (in the **Electric field components** fields). The name can be changed but the names of fields and dependent variables must be unique within a model.

#### DISCRETIZATION

Select the shape order for the **Electric field** dependent variable — **Linear**, **Quadratic** (the default), or **Cubic**. For more information about the **Discretization** section, see [Settings for the Discretization Sections](#) in the *COMSOL Multiphysics Reference Manual*.

## *Asymptotic Scattering*

---

Asymptotic scattering domain assigns a user-defined background field to the dependent variable on adjacent boundaries.

## *Far-Field Calculation*

---

Use a **Far-Field Calculation** to select boundaries corresponding to a single closed surface surrounding all radiating and scattering objects. By default, all exterior boundaries of the simulation domain are selected.

### **FAR-FIELD CALCULATION**

Enter a **Far-field variable name**. The default is  $E_{far}$ .

### **ADVANCED SETTINGS**

To display this section, click the **Show More Options** button (  ) and select **Advanced Physics Options** in the **Show More Options** dialog box.

For a discussion about the settings in this section, see [Advanced Settings](#) in the documentation for [The Electromagnetic Waves, Frequency Domain Interface](#).

## *Initial Values*



---

The **Initial Values** node adds an initial value for the electric field that can be used to perform the far-field transformation for a single frequency case without running the complete computation.

### **INITIAL VALUES**

Enter values or expressions for the initial values of the components of the **Electric field**  $E$  (SI unit: V/m). The default values are set by the background field.

# The Electromagnetic Waves, Boundary Elements Interface

The **Electromagnetic Waves, Boundary Elements (embe)** interface () is used to solve for time-harmonic electromagnetic field distributions. This interface is found under the **Radio Frequency** branch () when adding a physics interface. The formulation is based on the boundary element method (BEM) and is available in 2D and 3D. The physics interface solves the vector Helmholtz equation for piecewise-constant material properties and uses the electric field as dependent variable.

The interface is fully multiphysics enabled and can be coupled seamlessly with the physics interfaces that are based on the finite element method (FEM). This approach allows modeling in a FEM-BEM framework, exploiting the strength of both formulations to the fullest. The BEM-based interface is especially well suited for radiation and scattering problems.

The advantage of the boundary element method is that only boundaries need to be meshed and the degrees of freedom (DOFs) solved for are restricted to the boundaries. This introduces some clear ease-of-use for handling complex geometries. However, the BEM technique results in fully populated or dense matrices that need dedicated numerical methods. The BEM method is so to speak more expensive per DOF than the FEM method, but has fewer DOFs. Assembling and solving these can be very demanding. This means that when solving models of small and medium size, [The Electromagnetic Waves, Frequency Domain Interface](#) will often be faster, than solving the same problem with the BEM interface. The challenge for the FEM interface is to set up open boundaries, for example, using Perfectly Matched Layers (PMLs) in an efficient way. When the geometries are complex or two structures are far apart, large air domains need to be meshed. This costs a lot on the computational side as the frequency is increased.

For large models (problems that contain many wavelengths, at high frequency or for large domains) the stabilized formulation option (see [Stabilization](#)) ensures efficient convergence at the cost of some additional degrees of freedom. For low to medium frequencies (small to medium models), running without stabilization is more efficient. The stabilized formulation only gives a benefit in computing time for the large models.

For this physics interface, the maximum mesh element size should well resolve the complex electric field on the boundaries. Thus, if the wave propagates tangentially to



the boundary, the maximum mesh size should be a fraction of the wavelength. However, if the wave propagates essentially in the normal direction to the boundary, the maximum mesh element size can be larger. The physics interface supports the Frequency Domain study types. The Frequency Domain study type is used for source driven simulations for a single frequency or a sequence of frequencies.



In the *COMSOL Multiphysics Reference Manual* see the [Theory for the Boundary Elements PDE](#) section for more information about the Boundary Element Method.

When this physics interface is added, these default nodes are also added to the **Model Builder** — **Wave Equation**, **Electric**, **Perfect Electric Conductor**, and **Initial Values**. Then, from the **Physics** toolbar, add other nodes that implement, for example, boundary conditions. You can also right-click **Electromagnetic Waves**, **Boundary Elements** to select physics features from the context menu.



If both [The Electromagnetic Waves, Frequency Domain Interface](#) and [The Electromagnetic Waves, Boundary Elements Interface](#) are available, the [Electric Field Coupling](#) node is available from the **Multiphysics** menu in the **Physics** toolbar or by right-clicking the **Multiphysics Couplings** node in **Model Builder**.



[The Electromagnetic Waves, Frequency Domain Interface](#) and [The Electromagnetic Waves, Boundary Elements Interface](#) can also be coupled by using the same name for the dependent variable for both interfaces. Then [Electric Field Coupling](#) is not needed. How to set the name for the dependent variable is described in the [Dependent Variables](#) section.

#### *Physics-Controlled Mesh*

The physics-controlled mesh only defines mesh settings for the boundaries. It is controlled from the **Settings** window for the **Mesh** node (if the **Sequence type** is **Physics-controlled mesh**). In the table in the **Physics-Controlled Mesh** section, find the physics interface in the **Contributor** column and select or clear the check box in the **Use** column on the same row for enabling (the default) or disabling contributions from the physics interface to the physics-controlled mesh.

When the **Use** check box for the physics interface is selected, this invokes a parameter for the maximum mesh element size in free space. The physics-controlled mesh

automatically scales the maximum mesh element size as the wavelength changes in different dielectric and magnetic regions.

When the **Use** check box is selected for the physics interface, in the section for the physics interface below the table, choose one of the four options for the **Maximum mesh element size control parameter** — **From study** (the default), **User defined**, **Frequency**, or **Wavelength**. When **From study** is selected,  $1/5$  of the vacuum wavelength from the highest frequency defined in the study step is used for the maximum mesh element size. For the option **User defined**, enter a suitable **Maximum element size in free space**. For example,  $1/5$  of the vacuum wavelength or smaller. When **Frequency** is selected, enter the highest frequency intended to be used during the simulation. The maximum mesh element size in free space is  $1/5$  of the vacuum wavelength for the entered frequency. For the **Wavelength** option, enter the smallest vacuum wavelength intended to be used during the simulation. The maximum mesh element size in free space is  $1/5$  of the entered wavelength.

The maximum mesh element size in dielectric media is equal to the maximum mesh element size in vacuum divided by the square root of the product of the relative permittivity and permeability.



In the *COMSOL Multiphysics Reference Manual* see the [Physics-Controlled Mesh](#) section for more information about how to define the physics-controlled mesh.

---

## SETTINGS

The **Label** is the default physics interface name.

The **Name** is used primarily as a scope prefix for variables defined by the physics interface. Refer to such physics interface variables in expressions using the pattern `<name>.<variable_name>`. In order to distinguish between variables belonging to different physics interfaces, the `name` string must be unique. Only letters, numbers, and underscores (`_`) are permitted in the **Name** field. The first character must be a letter.

The default **Name** (for the first physics interface in the model) is `embe`.

## DOMAIN SELECTION

From the **Selection** list, select any of the options — **Manual**, **All domains**, **All voids**, or **All domains and voids** (the default). The geometric entity list displays the selected domain entity numbers. Edit the list of selected domain entity numbers using the selection toolbar buttons to the right of the list or by selecting the geometric entities in the

**Graphics** window. Entity numbers for voids can be entered by clicking the Paste () button in the selection toolbar and supplying the entity numbers in the dialog box. The entity number for the infinite void is 0, and finite voids have negative entity numbers.

Selections can also be entered using the **Selection List** window, available from the **Windows** menu on the **Home** toolbar.



For more information about making selections, see [Working with Geometric Entities](#) in the *COMSOL Multiphysics Reference Manual*.

---

## COMPONENTS

This section is available for 2D components.

Select the **Electric field components solved for** — **Three-component vector**, **Out-of-plane vector**, or **In-plane vector**. Select:

- **Three-component vector** (the default) to solve using a full three-component vector for the electric field  $\mathbf{E}$ .
- **Out-of-plane vector** to solve for the electric field vector component perpendicular to the modeling plane, assuming that there is no electric field in the plane.
- **In-plane vector** to solve for the electric field vector components in the modeling plane assuming that there is no electric field perpendicular to the plane.

## FORMULATION

From the **Formulation** list, select whether to solve for the **Full field** (the default) or the **Scattered field**.

For **Scattered field** select a **Background wave type** according to the following table:

TABLE 4-3: BACKGROUND WAVE TYPE BASED ON COMPONENT DIMENSION

COMPONENT	BACKGROUND WAVE TYPE
2D	User defined (default), Gaussian beam
3D	User defined (default), Gaussian beam, Linearly polarized plane wave



The scattered field formulation supports both metallic PEC scatterers and dielectric scatterers. Notice that a [Wave Equation, Electric](#) can be active on multiple domains provided that each material parameter (**Relative permittivity**, **Relative permeability**, and **Electrical conductivity**) has the same constant value in all the selected domains. In brief, there needs to be a [Wave Equation, Electric](#) node for each dielectric material.

When multiple [Wave Equation, Electric](#) nodes exist, the Infinite void selection needs to correspond to the first [Wave Equation, Electric](#) node and cannot coexist with other domain selections.

#### *User Defined*

Enter the component expressions for the **Background electric field**  $\mathbf{E}_b$  (SI unit: V/m). The entered expressions must be differentiable.



Notice that expressions including coupling operators are not differentiable and cannot be used as background fields.

#### *Gaussian Beam*

For **Gaussian beam** select the **Gaussian beam type** — **Paraxial approximation** (the default) or **Plane wave expansion**.

When selecting **Paraxial approximation**, the Gaussian beam background field is a solution to the paraxial wave equation, which is an approximation to the Helmholtz equation solved for by the **Electromagnetic Waves, Boundary Elements (embe)** interface. The approximation is valid for Gaussian beams that have a beam radius that is much larger than the wavelength. Since the paraxial Gaussian beam background field is an approximation to the Helmholtz equation, for tightly focused beams, you can get a nonzero scattered field solution, even if you do not have any scatterers. The option **Plane wave expansion** means that the electric field for the Gaussian beam is approximated by an expansion of the electric field into a number of plane waves. Since each plane wave is a solution to the Helmholtz equation, the plane wave expansion of

the electric field is also a solution to the Helmholtz equation. Thus, this option can be used also for tightly focused Gaussian beams.

If the beam spot radius is smaller than the wavelength, evanescent plane waves need to be included in the expansion. The evanescent waves decay exponentially in the propagation direction, why it only makes sense to model such tightly focused beams if the focal plane coincides with the input boundary. If the focal plane is located inside the modeled domain, the field can be dominated by the exponentially decaying evanescent waves. Those waves can have a very high field strength before the focal plane even though they only provide a small contribution to the field at the focal plane.

For **Plane wave expansion** select **Wave vector distribution type** — **Automatic** (the default) or **User defined**. For **Automatic** also check **Allow evanescent waves**, to include evanescent waves in the plane wave expansion. For **User defined** also enter values for the **Wave vector count**  $N_{\mathbf{k}}$  (the default value is 13) and **Maximum transverse wave number**  $k_{t,\max}$  (SI unit: rad/m, default value is  $(2 \cdot \sqrt{2 \cdot \log(10)}) / \text{embe.w0}$ ). Use an odd number for the **Wave vector count**  $N_{\mathbf{k}}$  to make sure that a wave vector pointing in the main propagation direction is included in the plane-wave expansion. The **Wave vector count**  $N_{\mathbf{k}}$  specifies the number of wave vectors that will be included per transverse dimension. So for 3D the total number of wave vectors will be  $N_{\mathbf{k}} \cdot N_{\mathbf{k}} \cdot N_{\mathbf{k}}$ .



Evanescent waves are included in the plane wave expansion if the **Maximum transverse wave number**  $k_{t,\max}$  is larger than the specified **Wave number**  $k$ . When the **Wave vector distribution type** is set to **Automatic**, evanescent waves are included in the expansion if the **Allow evanescent waves** check box is selected.

A plane wave expansion with a finite number of plane waves included will make the field periodic in the plane orthogonal to the main propagation direction. If the separation between the transverse wave vector components, given by  $2k_{t,\max} / (N_{\mathbf{k}} - 1)$ , is too small, replicas of the Gaussian beam background field can appear. To avoid that, increase the value for the **Wave vector count**  $N_{\mathbf{k}}$ .

The number of plane waves included in the expansion can be quite large, especially for 3D. For instance, using the default settings,  $2 \cdot 13 \cdot 13 = 338$  plane waves will be included (the factor 2 accounts for the two possible polarizations for each wave vector). Thus, initializing the plane-wave expansion for the Gaussian beam background field can take some time in 3D.

For more information about the Gaussian beam theory, see [Gaussian Beams as Background Fields and Input Fields](#).

Define the Gaussian beam background field using the parameters below:

- Select a **Beam orientation**: **Along the x-axis** (the default), **Along the y-axis**, or for 3D components, **Along the z-axis**.
- Enter a **Beam radius**  $w_0$  (SI unit: m). The default is  $20\pi/\text{embe.k}_0$  m (10 vacuum wavelengths).
- Enter a **Focal plane along the axis**  $p_0$  (SI unit: m). The default is 0 m.
- Select an **Input quantity**: **Electric field amplitude** (the default) or **Power**.
- Enter the component expressions for the **Transverse background electric field amplitude, Gaussian beam**  $\mathbf{E}_{Tbg0}$  (SI unit: V/m) if the **Input quantity** is **Electric field amplitude**. Notice that this is the transverse Gaussian beam amplitude in the focal plane. When the **Gaussian beam type** is set to **Paraxial approximation** the background field is always orthogonal (transverse) to **Beam orientation**. However, when the **Gaussian beam type** is set to **Plane wave expansion**, the background field amplitude can also have a component in the propagation direction. Specify here only the field amplitude components that are orthogonal to the propagation direction. COMSOL computes automatically the component in the propagation direction, if needed.
- If the **Input quantity** is set to **Power**, enter the **Input power** (SI unit: W in 2D axisymmetry and 3D and W/m in 2D) and the component expressions for the **Non-normalized transverse electric field amplitude, Gaussian beam**  $\mathbf{E}_{Tbg0}$  (SI unit: V/m).
- Enter a **Wave number**  $k$  (SI unit: rad/m). The default is  $\text{embe.k}_0$  rad/m. The wave number must evaluate to a value that is the same for all the domains the scattered field is applied to. Setting the **Wave number**  $k$  to a positive value, means that the wave is propagating in the positive  $x$ -,  $y$ -, or  $z$ -axis direction, whereas setting the **Wave number**  $k$  to a negative value means that the wave is propagating in the negative  $x$ -,  $y$ -, or  $z$ -axis direction.

#### *Linearly Polarized Plane Wave*

The initial background wave is predefined as  $\mathbf{E}_0 = \exp(-jk_x x)\mathbf{z}$ . This field is transformed by three successive rotations along the roll, pitch, and yaw angles, in that order. For a graphic representation of the initial background field and the definition of the three rotations compare with [Figure 4-1](#) below.

- Enter an **Electric field amplitude**  $E_0$  (SI unit: V/m). The default is 1 V/m.

- Enter a **Roll angle** (SI unit: rad), which is a right-handed rotation with respect to the  $+x$  direction. The default is 0 rad, corresponding to polarization along the  $+z$  direction.
- Enter a **Pitch angle** (SI unit: rad), which is a right-handed rotation with respect to the  $+y$  direction. The default is 0 rad, corresponding to the initial direction of propagation pointing in the  $+x$  direction.
- Enter a **Yaw angle** (SI unit: rad), which is a right-handed rotation with respect to the  $+z$  direction.
- Enter a **Wave number  $k$**  (SI unit: rad/m). The default is `embe.k0` rad/m. The wave number must evaluate to a value that is the same for the domains the scattered field is applied to.

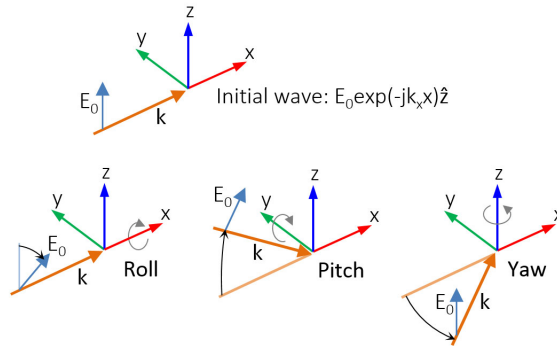

*Figure 4-8: Schematic of the directions for the wave vector  $\mathbf{k}$ , the electric field  $\mathbf{E}_0$ , and the roll, pitch and yaw rotations. The top image represents an initial wave propagating in the  $x$  direction with a polarization along the  $z$  direction.*

## STABILIZATION

To display this section, click the **Show More Options** button (  ) and select **Stabilization** in the **Show More Options** dialog box.

For large models (problems that contain many wavelengths, at high frequency or for large domains) enable the **Use stabilization** option (enable by default) to ensure efficient convergence at the cost of some additional degrees of freedom.

When **Use stabilization** is selected, a text field for the **Stabilization parameter** is enabled with the default value `sqrt(abs(embe.k[m]))`. This is a parameter that should scale inversely with the wavelength. The default gives good performance in most cases.

## FAR-FIELD APPROXIMATION

To display this section, click the **Show More Options** button (  ) and select **Advanced Physics Options** in the **Show More Options** dialog box.



For more information about the **Far Field Approximation** settings, see [Far-Field Approximation Settings](#) in the *COMSOL Multiphysics Reference Manual*.

When **Use far-field approximation for matrix assembly** is selected, a text field for the **Minimum near field range in vacuum for preconditioning** is enabled with the default value  $((2 \cdot \pi) / \text{embe.k0}) / 10$  (one tenth of a wavelength). For problems having a wide distribution of mesh element sizes, including mesh elements that are much smaller than the wavelength, a smaller value for this parameter may make the iterative solver convergence faster.

Using a smaller value for this parameter, may make problems having a large distribution of mesh element sizes, including mesh elements that are much smaller than the wavelength, converge faster with the iterative solver. However, a smaller value use more memory.

## QUADRATURE

To display this section, click the **Show More Options** button (  ) and select **Advanced Physics Options** in the **Show More Options** dialog box.



For more information about the **Quadrature** settings, see [Quadrature](#) in the *COMSOL Multiphysics Reference Manual*.

## DISCRETIZATION

From the **Electric field/Flux field** list, choose from predefined options for the boundary element discretization order for the electric field variable and the flux field (magnetic field) variable, respectively. The predefined options represent the suitable combinations of element orders such as **Quadratic/Linear** (the default). For more information about the **Discretization** section, see [Settings for the Discretization Sections](#) in the *COMSOL Multiphysics Reference Manual*.



## DEPENDENT VARIABLES

The dependent variables (field variables) are for the **Electric field  $\mathbf{E}$**  and its components (in the **Electric field components** fields). The name can be changed but the names of fields and dependent variables must be unique within a model.

### *Domain, Boundary, Edge, Point, and Pair Nodes for the Electromagnetic Waves, Boundary Elements Interface*

---

The [Electromagnetic Waves, Frequency Domain Interface](#) has these domain, boundary, edge, point, and pair nodes and subnodes. The nodes are listed in alphabetical order and are available from the **Physics** ribbon toolbar (Windows users), **Physics** context menu (Mac or Linux users), or by right-clicking to access the context menu (all users).



In general, to add a node, go to the **Physics** toolbar, no matter what operating system you are using. Subnodes are available by clicking the parent node and selecting it from the **Attributes** menu.

---

## DOMAIN

- [Initial Values](#)
- [Wave Equation, Electric](#)

## BOUNDARY CONDITIONS

With no surface currents present, the boundary conditions

$$\mathbf{n}_2 \times (\mathbf{E}_1 - \mathbf{E}_2) = \mathbf{0}$$

$$\mathbf{n}_2 \times (\mathbf{H}_1 - \mathbf{H}_2) = \mathbf{0}$$

need to be fulfilled. Because  $\mathbf{E}$  is being solved for, the tangential component of the electric field is always continuous, and thus the first condition is automatically fulfilled. The second condition is equivalent to the natural boundary condition

$$-\mathbf{n} \times [(\mu_r^{-1} \nabla \times \mathbf{E})_1 - (\mu_r^{-1} \nabla \times \mathbf{E})_2] = \mathbf{n} \times j\omega\mu_0(\mathbf{H}_1 - \mathbf{H}_2) = \mathbf{0}$$

and is therefore also fulfilled. The [Far-Field Calculation](#) condition is described in this section.

The following features are also available and described for [The Electromagnetic Waves, Frequency Domain Interface](#):

- [Electric Field](#)
- [Perfect Electric Conductor](#)
- [Lumped Port](#)
- [Perfect Magnetic Conductor](#)
- [Surface Current Density](#)



In the *COMSOL Multiphysics Reference Manual* see [Table 2-4](#) for links to common sections and [Table 2-5](#) to common feature nodes. You can also search for information: press F1 to open the **Help** window or Ctrl+F1 to open the **Documentation** window.

### *Wave Equation, Electric*

**Wave Equation, Electric** is the main feature node for this physics interface. The governing equation can be written in the form

$$\mu_r^{-1} \nabla \times (\nabla \times \mathbf{E}) - k_0^2 \epsilon_r \mathbf{E} = \mathbf{0}$$

for the time-harmonic and eigenfrequency problems. The wave number of free space  $k_0$  is defined as

$$k_0 = \omega \sqrt{\epsilon_0 \mu_0} = \frac{\omega}{c_0}$$

where  $c_0$  is the speed of light in vacuum.

#### **MATERIAL PROPERTIES**

The default **Relative permittivity**  $\epsilon_r$ , **Relative permeability**  $\mu_r$ , and **Electrical conductivity**  $\sigma$  take values **From material**. For **User defined** enter a value or expression in the field.



Notice that the boundary element method is based on the availability of an analytic Green's function for the domain. Thus, the **Relative permittivity**, the **Relative permeability**, and the **Electrical conductivity** must all evaluate to constant values for each **Wave Equation, Electric** node.

## *Initial Values*

---

The **Initial Values** node adds an initial value for the electric field that can serve as an initial guess for a nonlinear solver. Add additional **Initial Values** nodes from the **Physics** toolbar.

### **INITIAL VALUES**

Enter values or expressions for the initial values of the components of the **Electric field**  $E$  (SI unit: V/m). The default values are 0 V/m.

## *Far-Field Calculation*

---

Use a **Far-Field Calculation** to select boundaries corresponding to a single closed surface surrounding all radiating and scattering objects. By default, all exterior boundaries of the simulation domain are selected.

### **FAR-FIELD CALCULATION**

Enter a **Far-field variable name**. The default is  $E_{far}$ .

### **ADVANCED SETTINGS**

To display this section, click the **Show More Options** button (  ) and select **Advanced Physics Options** in the **Show More Options** dialog box.

For a discussion about the settings in this section, see [Advanced Settings](#) in the documentation for [The Electromagnetic Waves, Frequency Domain Interface](#).

## *Electric Field Coupling*

---

The **Electric Field Coupling** multiphysics node assures continuity of the electric potential across boundaries between [The Electromagnetic Waves, Frequency Domain Interface](#) and [The Electromagnetic Waves, Boundary Elements Interface](#). The **Electric Field Coupling** node is available from the **Multiphysics** menu in the **Physics** toolbar or by right-clicking the **Multiphysics Couplings** node in **Model Builder**, if both [The Electromagnetic Waves, Frequency Domain Interface](#) and [The Electromagnetic Waves, Boundary Elements Interface](#) are available.

### **BOUNDARY SELECTION**

Select **Manual** or **All boundaries** from the **Selection** list. Make additional edits to the list of boundary entity numbers using the **Selection** toolbar buttons. When **All boundaries** is selected from the **Selection** list, the boundaries exterior to the Electromagnetic

Waves, Frequency Domain interface that intersect the exterior boundaries to the Electromagnetic Waves, Boundary Elements interface are available in the boundary entity number list.

### COUPLED INTERFACES

Select **Electromagnetic Waves, Frequency Domain** as **Primary interface** and **Electromagnetic Waves, Boundary Elements** as **Secondary interface**.



*FEM-BEM Coupling of a Microstrip Patch Antenna:* Application Library path **RF\_Module/Antennas/microstrip\_patch\_antenna\_fem\_bem** demonstrates how to use the [Electric Field Coupling](#) node to couple [The Electromagnetic Waves, Frequency Domain Interface](#) and [The Electromagnetic Waves, Boundary Elements Interface](#).

### *Lumped Port*

Use the **Lumped Port** node to apply a voltage or current excitation of a model or to connect to a circuit. A lumped port is a simplification of the port boundary condition.

#### LUMPED PORT PROPERTIES

Enter a unique **Lumped port name**. It is recommended to use a numeric name as it is used to define the elements of the S-parameter matrix and numeric port names are also required for port sweeps and Touchstone file export.

#### *Type of Lumped Port*

Select a **Type of lumped port** — **Coaxial**, **User defined**, or **Via**.

Select **User defined** for nonuniform ports, for example, a curved port and enter values or expressions in the fields — **Height of lumped port**  $h_{\text{port}}$  (SI unit: m), **Width of lumped port**  $w_{\text{port}}$  (SI unit: m), and **Direction between lumped port terminals**  $\mathbf{a}_h$ .

Select **Via** for excitation or termination of a cylindrical shape of a structure used in a metalized via that is a plated through hole.

#### *Terminal Type*

For the **Terminal type** — a **Cable** port is available for a voltage driven transmission line and S-parameter calculation.

For **Cable**, select **On** or **Off** from the **Wave excitation at this port** list to set whether it is an inport (excitation) or a listener port (observation).

## SETTINGS

### *Source Type*

If **On** is selected for the **Wave excitation at this port**, select **Voltage** or **Power** from the **Source type**. For the **Voltage** source type, enter a **Voltage**  $V_0$  (SI unit: V), and **Port phase**  $\theta_{in}$  (SI unit: rad). For the **Power** source type, enter a **Power**  $P_0$  (SI unit: W) that is the average input power to the lumped port.

Note it is only possible to excite one **Cable** port at a time if the purpose is to compute S-parameters. In other cases, for example, when more than one inport might be wanted, but the S-parameter variables cannot be correctly computed so if several ports are excited, the S-parameter output is turned off.

The [Port Sweep Settings](#) cycle through the ports, computes the entire S-matrix, and exports it to a Touchstone file. When using port sweeps, the local setting for **Wave excitation at this port** is overridden by the solver so only one port at a time is excited.

Enter the **Characteristic impedance**  $Z_{ref}$  (SI unit:  $\Omega$ ).

# The Electromagnetic Waves, FEM-BEM Interface

The **Electromagnetic Waves, FEM-BEM** interface () allows to build hybrid FEM-BEM models, where the boundary element method (BEM) is used to compute the electric fields outside the finite element method (FEM) domains. This multiphysics interface adds an **Electromagnetic Waves, Frequency Domain** interface and an **Electromagnetic Waves, Boundary Elements** interface. The multiphysics coupling assures continuity of the tangential electric fields across boundaries between the two interfaces.

Frequency-domain modeling is supported in 2D and 3D.

When a predefined **Electromagnetic Waves, FEM-BEM** interface is added from the **Radio Frequency** branch () of the **Model Wizard** or **Add Physics** window, the **Electromagnetic Waves, Frequency Domain** and **Electromagnetic Waves, Boundary Elements** interfaces are added to the Model Builder.

In addition, a **Multiphysics** node is added, which automatically includes the multiphysics coupling feature **Electric Field Coupling**.

## *On the Constituent Physics Interfaces*

The **Electromagnetic Waves, Frequency Domain** interface computes time-harmonic electromagnetic field distributions. To use this physics interface, the maximum mesh element size should be limited to a fraction of the wavelength. Thus, the domain size that can be simulated scales with the amount of available computer memory and the wavelength. The physics interface solves the time-harmonic wave equation for the electric field.

The **Electromagnetic Waves, Boundary Elements** interface is used to solve for time-harmonic electromagnetic field distributions. This interface is especially well suited for radiation and scattering problems since only boundaries need to be meshed and the degrees of freedom (DOFs) solved for are restricted to the boundaries. To use this physics interface, the maximum mesh element size should well resolve the complex electric field on the boundaries. The physics interface solves the vector Helmholtz equation for piecewise-constant material properties and uses the electric field as dependent variable.

## SETTINGS FOR PHYSICS INTERFACES AND COUPLING FEATURE

When physics interfaces are added using the predefined couplings, for example **Electromagnetic Waves, FEM-BEM**, specific settings are included with the physics interfaces and the coupling features.

However, if physics interfaces are added one at a time, followed by the coupling features, these modified settings are not automatically included.

For example, if single **Electromagnetic Waves, Frequency Domain** and **Electromagnetic Waves, Boundary Elements** interfaces are added, COMSOL Multiphysics adds an empty **Multiphysics** node. You can add the **Electromagnetic Waves, FEM-BEM** coupling feature, but no modified settings are included.



Coupling features are available from the context menu (right-click the **Multiphysics** node) or from the **Physics** toolbar, **Multiphysics** menu.

TABLE 4-4: MODIFIED SETTINGS FOR A ELECTROMAGNETIC WAVES, FEM-BEM INTERFACE

PHYSICS INTERFACE OR COUPLING FEATURE	MODIFIED SETTINGS (IF ANY)
Electromagnetic Waves, Frequency Domain	No changes.
Electromagnetic Waves, Boundary Elements	No changes.
Electromagnetic Waves, FEM-BEM	The <b>Domain Selection</b> is the same as that of the participating physics interfaces. The <b>Boundary Selection</b> is the same as the exterior and interior boundaries of the <b>Domain Selection</b> of the participating physics interfaces. The corresponding <b>Electromagnetic Waves, Frequency Domain</b> and <b>Electromagnetic Waves, Boundary Elements</b> interfaces are preselected in the <a href="#">Coupled Interfaces</a> section (described in the <i>COMSOL Multiphysics Reference Manual</i> ).

## PHYSICS INTERFACES AND COUPLING FEATURE



Use the online help in COMSOL Multiphysics to locate and search all the documentation. All these links also work directly in COMSOL Multiphysics when using the Help system.

### *Coupling Feature*

The [Electric Field Coupling](#) feature is described in the documentation for [The Electromagnetic Waves, Boundary Elements Interface](#).

### *Physics Interface Features*

Physics nodes are available from the **Physics** ribbon toolbar (Windows users), **Physics** context menu (Mac or Linux users), or right-click to access the context menu (all users).



In general, to add a node, go to the **Physics** toolbar, no matter what operating system you are using. Subnodes are available by clicking the parent node and selecting it from the **Attributes** menu.

---

- The available physics features for [The Electromagnetic Waves, Frequency Domain Interface](#) are listed in the section [Domain, Boundary, Edge, Point, and Pair Nodes for the Electromagnetic Waves, Frequency Domain Interface](#).
- The available physics features for [The Electromagnetic Waves, Boundary Elements Interface](#) are listed in the section [Domain, Boundary, Edge, Point, and Pair Nodes for the Electromagnetic Waves, Boundary Elements Interface](#).



# Theory for the Electromagnetic Waves Interfaces

The Electromagnetic Waves, Frequency Domain Interface and The Electromagnetic Waves, Transient Interface theory is described in this section:

- [Introduction to the Physics Interface Equations](#)
- [Frequency Domain Equation](#)
- [Time Domain Equation](#)
- [Curl Elements](#)
- [Eigenfrequency Calculations](#)
- [Gaussian Beams as Background Fields and Input Fields](#)
- [Linearly Polarized Plane Wave as Background Field in 2D Axisymmetry](#)
- [Periodic Port Mode Fields](#)
- [Effective Material Properties in Effective Media and Mixtures](#)
- [Effective Conductivity in Effective Media and Mixtures](#)
- [Effective Relative Permittivity in Effective Media and Mixtures](#)
- [Effective Relative Permeability in Effective Media and Mixtures](#)
- [Archie's Law Theory](#)

## *Introduction to the Physics Interface Equations*

---

Formulations for high-frequency waves can be derived from Maxwell–Ampère’s and Faraday’s laws,

$$\begin{aligned}\nabla \times \mathbf{H} &= \mathbf{J} + \frac{\partial \mathbf{D}}{\partial t} \\ \nabla \times \mathbf{E} &= -\frac{\partial \mathbf{B}}{\partial t}\end{aligned}$$

Using the constitutive relations for linear materials  $\mathbf{D} = \epsilon \mathbf{E}$  and  $\mathbf{B} = \mu \mathbf{H}$  as well as a current  $\mathbf{J} = \sigma \mathbf{E}$ , these two equations become

$$\begin{aligned}\nabla \times \mathbf{H} &= \sigma \mathbf{E} + \frac{\partial \epsilon \mathbf{E}}{\partial t} \\ \nabla \times \mathbf{E} &= -\mu \frac{\partial \mathbf{H}}{\partial t}\end{aligned}$$

### *Frequency Domain Equation*

---

Writing the fields on a time-harmonic form, assuming a sinusoidal excitation and linear media,

$$\begin{aligned}\mathbf{E}(x, y, z, t) &= \mathbf{E}(x, y, z) e^{j\omega t} \\ \mathbf{H}(x, y, z, t) &= \mathbf{H}(x, y, z) e^{j\omega t}\end{aligned}$$

the two laws can be combined into a time-harmonic equation for the electric field or a similar equation for the magnetic field

$$\begin{aligned}\nabla \times (\mu^{-1} \nabla \times \mathbf{E}) - \omega^2 \epsilon \mathbf{E} &= \mathbf{0} \\ \nabla \times (\epsilon^{-1} \nabla \times \mathbf{H}) - \omega^2 \mu \mathbf{H} &= \mathbf{0}\end{aligned}$$

The first of these is based on the electric field is used in [The Electromagnetic Waves, Frequency Domain Interface](#).

Using the relation  $\epsilon_r = n^2$ , where  $n$  is the refractive index, the equation can alternatively be written

$$\nabla \times (\nabla \times \mathbf{E}) - k_0^2 n^2 \mathbf{E} = \mathbf{0}$$

The wave number in vacuum  $k_0$  is defined by

$$k_0 = \omega \sqrt{\epsilon_0 \mu_0} = \frac{\omega}{c_0}$$

where  $c_0$  is the speed of light in vacuum.

When the equation is written using the refractive index, the assumption is that  $\mu_r = 1$  and  $\sigma = 0$  and only the constitutive relations for linear materials are available. When solving for the scattered field the same equations are used but  $\mathbf{E} = \mathbf{E}_{sc} + \mathbf{E}_i$  and  $\mathbf{E}_{sc}$  is the dependent variable.

## EIGENFREQUENCY ANALYSIS

When solving the frequency domain equation as an eigenfrequency problem the eigenvalue is the complex eigenfrequency  $\lambda = j\omega + \delta$ , where  $\delta$  is the damping of the solution. The *Q factor* is given from the eigenvalue by the formula

$$Q_{\text{fact}} = \frac{\omega}{2|\delta|}$$

## MODE ANALYSIS AND BOUNDARY MODE ANALYSIS

In mode analysis and boundary mode analysis, the COMSOL Multiphysics software solves for the propagation constant. The time-harmonic representation is almost the same as for the eigenfrequency analysis, but with a known propagation in the out-of-plane direction

$$\mathbf{E}(\mathbf{r}, t) = \text{Re}(\tilde{\mathbf{E}}(\mathbf{r}_T)e^{j\omega t - j\beta z}) = \text{Re}(\tilde{\mathbf{E}}(\mathbf{r})e^{j\omega t - \alpha z})$$

The spatial parameter,  $\alpha = \delta_z + j\beta = -\lambda$ , can have a real part and an imaginary part. The propagation constant is equal to the imaginary part, and the real part,  $\delta_z$ , represents the damping along the propagation direction. When solving for all three electric field components the allowed anisotropy of the optionally complex relative permittivity and relative permeability is limited to:

$$\epsilon_{rc} = \begin{bmatrix} \epsilon_{rxx} & \epsilon_{rxy} & 0 \\ \epsilon_{ryx} & \epsilon_{ryy} & 0 \\ 0 & 0 & \epsilon_{rzz} \end{bmatrix} \quad \mu_r = \begin{bmatrix} \mu_{rxx} & \mu_{rxy} & 0 \\ \mu_{ryx} & \mu_{ryy} & 0 \\ 0 & 0 & \mu_{rzz} \end{bmatrix}$$



Limiting the electric field component solved for to the out-of-plane component for TE modes requires that the medium is homogeneous; that is,  $\mu$  and  $\epsilon$  are constant. When solving for the in-plane electric field components for TM modes,  $\mu$  can vary but  $\epsilon$  must be constant. It is strongly recommended to use the most general approach, that is solving for all three components which is sometimes referred to as “perpendicular hybrid-mode waves”.

### Variables Influenced by Mode Analysis

The following table lists the variables that are influenced by the mode analysis:

NAME	EXPRESSION	CAN BE COMPLEX	DESCRIPTION
beta	imag(-lambda)	No	Propagation constant
dampz	real(-lambda)	No	Attenuation constant
dampzdB	20*log10(exp(1))*dampz	No	Attenuation per meter in dB
neff	j*lambda/k0	Yes	Effective mode index

### PROPAGATING WAVES IN 2D

In 2D, different polarizations can be chosen by selecting to solve for a subset of the 3D vector components. When selecting all three components, the 3D equation applies with the addition that out-of-plane spatial derivatives are evaluated for the prescribed out-of-plane wave vector dependence of the electric field.

In 2D, the electric field varies with the out-of-plane wave number  $k_z$  as

$$\mathbf{E}(x, y, z) = \tilde{\mathbf{E}}(x, y) \exp(-ik_z z).$$

The wave equation is thereby rewritten as

$$(\nabla - ik_z \mathbf{z}) \times [\mu_r^{-1} (\nabla - ik_z \mathbf{z}) \times \tilde{\mathbf{E}}] - k_0^2 \epsilon_{rc} \tilde{\mathbf{E}} = \mathbf{0},$$

where  $\mathbf{z}$  is the unit vector in the out-of-plane  $z$  direction.

Similarly, in 2D axisymmetry, the electric field varies with the azimuthal mode number  $m$  as

$$\mathbf{E}(r, \varphi, z) = \tilde{\mathbf{E}}(r, z) \exp(-im\varphi)$$

and the wave equation is expressed as

$$\left( \nabla - i \frac{m}{r} \boldsymbol{\varphi} \right) \times \left[ \mu_r^{-1} \left( \nabla - i \frac{m}{r} \boldsymbol{\varphi} \right) \times \tilde{\mathbf{E}} \right] - k_0^2 \epsilon_{rc} \tilde{\mathbf{E}} = \mathbf{0},$$

where  $\boldsymbol{\varphi}$  is the unit vector in the out-of-plane  $\varphi$ -direction.

#### Covariant formulation

In the 2D axisymmetric formulation, it is beneficial to formulate the out-of-plane dependent variable as

$$\Psi = r\mathbf{E}_\varphi,$$

referred to as the covariant formulation. Here,  $\Psi$  is the dependent variable and the out-of-plane electric field component is calculated as

$$\mathbf{E}_\varphi = \Psi/r.$$

The covariant formulation has better performance in terms of numerical stability and accuracy. For eigenfrequency simulations, it also removes spurious solutions.

This formulation is used for all study types, except Mode Analysis and Boundary Mode Analysis.

#### *In-plane Hybrid-Mode Waves*

Solving for all three components in 2D is referred to as “hybrid-mode waves”. The equation is formally the same as in 3D with the addition that out-of-plane spatial derivatives are evaluated for the prescribed out-of-plane wave vector dependence of the electric field

#### *In-plane TM Waves*

The TM waves polarization has only one magnetic field component in the  $z$  direction, and the electric field lies in the modeling plane. Thus the time-harmonic fields can be obtained by solving for the in-plane electric field components only. The equation is formally the same as in 3D, the only difference being that the out-of-plane electric field component is zero everywhere and that out-of-plane spatial derivatives are evaluated for the prescribed out-of-plane wave vector dependence of the electric field.

#### *In-plane TE Waves*

As the field propagates in the modeling  $xy$ -plane a TE wave has only one nonzero electric field component, namely in the  $z$  direction. The magnetic field lies in the modeling plane. Thus the time-harmonic fields can be simplified to a scalar equation for  $\mathbf{E}_z$ ,

$$-\nabla \cdot (\tilde{\mu}_r \nabla \mathbf{E}_z) - \varepsilon_{rzz} k_0^2 \mathbf{E}_z = 0$$

where

$$\tilde{\mu}_r = \frac{\mu_r^T}{\det(\mu_r)}$$

To be able to write the fields in this form, it is also required that  $\epsilon_r$ ,  $\sigma$ , and  $\mu_r$  are nondiagonal only in the  $xy$ -plane.  $\mu_r$  denotes a 2-by-2 tensor, and  $\epsilon_{rzz}$  and  $\sigma_{zz}$  are the relative permittivity and conductivity in the  $z$  direction.

#### Axisymmetric Hybrid-Mode Waves

Solving for all three components in 2D is referred to as “hybrid-mode waves”. The equation is formally the same as in 3D with the addition that spatial derivatives with respect to  $\phi$  are evaluated for the prescribed azimuthal mode number dependence of the electric field.

#### Axisymmetric TM Waves

A TM wave has a magnetic field with only a  $\phi$  component and thus an electric field with components in the  $rz$ -plane only. The equation is formally the same as in 3D, the only difference being that the  $\phi$  component is zero everywhere and that spatial derivatives with respect to  $\phi$  are evaluated for the prescribed azimuthal mode number dependence of the electric field.

#### Axisymmetric TE Waves

A TE wave has only an electric field component in the  $\phi$  direction, and the magnetic field lies in the modeling plane. Given these constraints, the 3D equation can be simplified to a scalar equation for  $E_\phi$ . To write the fields in this form, it is also required that  $\epsilon_r$  and  $\mu_r$  are nondiagonal only in the  $rz$ -plane.  $\mu_r$  denotes a 2-by-2 tensor, while  $\epsilon_{r\phi\phi}$  and  $\sigma_{\phi\phi}$  are the relative permittivity and conductivity in the  $\phi$  direction.

## INTRODUCING LOSSES IN THE FREQUENCY DOMAIN

#### Electric Losses

The frequency domain equations allow for several ways of introducing electric losses. Finite conductivity results in a *complex permittivity*,

$$\epsilon_c = \epsilon - j\frac{\sigma}{\omega}$$

The conductivity gives rise to ohmic losses in the medium.

A more general approach is to use a complex permittivity,

$$\epsilon_c = \epsilon_0(\epsilon' - j\epsilon'')$$

where  $\epsilon'$  is the real part of  $\epsilon_r$ , and all losses (dielectric and conduction losses) are given by  $\epsilon''$ . The dielectric loss model can also single out the losses from finite conductivity (so that  $\epsilon''$  only represents dielectric losses) resulting in:

$$\epsilon_c = \epsilon_0 \left( \epsilon' - j \left( \frac{\sigma}{\omega \epsilon_0} + \epsilon'' \right) \right)$$

The complex permittivity can also be introduced as a loss tangent:

$$\epsilon_c = \epsilon_0 \epsilon' (1 - j \tan \delta)$$



When specifying losses through a loss tangent, conductivity is not allowed as an input.

In optics and photonics applications, the refractive index is often used instead of the permittivity. In materials where  $\mu_r$  is 1, the relation between the complex refractive index

$$\bar{n} = n - j\kappa$$

and the complex relative permittivity is

$$\epsilon_{rc} = \bar{n}^2$$

that is

$$\begin{aligned} \epsilon'_r &= n^2 - \kappa^2 \\ \epsilon''_r &= 2n\kappa \end{aligned}$$

The inverse relations are

$$\begin{aligned} n^2 &= \frac{1}{2} (\epsilon'_r + \sqrt{\epsilon_r'^2 + \epsilon_r''^2}) \\ \kappa^2 &= \frac{1}{2} (-\epsilon'_r + \sqrt{\epsilon_r'^2 + \epsilon_r''^2}) \end{aligned}$$

The parameter  $\kappa$  represents a damping of the electromagnetic wave. When specifying the refractive index, conductivity is not allowed as an input.

In the physics and optics literature, the time harmonic form is often written with a minus sign (and “ $i$ ” instead of “ $j$ ”):

$$\mathbf{E}(x, y, z, t) = \mathbf{E}(x, y, z) e^{-i\omega t}$$

This makes an important difference in how loss is represented by complex material coefficients like permittivity and refractive index, that is, by having a positive imaginary part rather than a negative one. Therefore, material data taken from the literature might have to be conjugated before using it in a model.

#### *Magnetic Losses*

The frequency domain equations allow for magnetic losses to be introduced as a *complex relative permeability*.

$$\mu_r = (\mu' - j\mu'')$$

The complex relative permeability can be combined with any electric loss model except refractive index.

#### *Time Domain Equation*

---

The relations  $\mu\mathbf{H} = \nabla \times \mathbf{A}$  and  $\mathbf{E} = -\partial\mathbf{A}/\partial t$  (using the gauge for which the scalar electric potential vanishes) make it possible to rewrite Maxwell-Ampère's law using the magnetic potential.

$$\mu_0\sigma\frac{\partial\mathbf{A}}{\partial t} + \mu_0\frac{\partial}{\partial t}\varepsilon\frac{\partial\mathbf{A}}{\partial t} + \nabla \times (\mu_r^{-1}\nabla \times \mathbf{A}) = 0$$

This is the equation used by [The Electromagnetic Waves, Transient Interface](#). It is suitable for the simulation of nonsinusoidal waveforms or nonlinear media.

Using the relation  $\varepsilon_r = n^2$ , where  $n$  is the refractive index, the equations can alternatively be written

$$\mu_0\varepsilon_0\frac{\partial}{\partial t}\left(n\frac{\partial\mathbf{A}}{\partial t}\right) + \nabla \times (\nabla \times \mathbf{A}) = 0$$

### **WAVES IN 2D**

In 2D, different polarizations can be chosen by selecting to solve for a subset of the 3D vector components. When selecting all three components, the 3D equation applies with the addition that out-of-plane spatial derivatives are set to zero.

#### *In-plane Hybrid-Mode Waves*

Solving for all three components in 2D is referred to as “hybrid-mode waves”. The equation form is formally the same as in 3D with the addition that out-of-plane spatial derivatives are set to zero.



### *In-plane TM Waves*

The TM waves polarization has only one magnetic field component in the  $z$  direction, and thus the electric field and vector potential lie in the modeling plane. Hence it is obtained by solving only for the in-plane vector potential components. The equation is formally the same as in 3D, the only difference being that the out-of-plane vector potential component is zero everywhere and that out-of-plane spatial derivatives are set to zero.

### *In-plane TE Waves*

As the field propagates in the modeling  $xy$ -plane a TE wave has only one nonzero vector potential component, namely in the  $z$  direction. The magnetic field lies in the modeling plane. Thus the equation in the time domain can be simplified to a scalar equation for  $A_z$ :

$$\mu_0 \sigma \frac{\partial A_z}{\partial t} + \mu_0 \epsilon_0 \frac{\partial}{\partial t} \left( \epsilon_r \frac{\partial A_z}{\partial t} \right) + \nabla \cdot (\mu_r^{-1} (\nabla A_z)) = 0$$

Using the relation  $\epsilon_r = n^2$ , where  $n$  is the refractive index, the equation can alternatively be written

$$\mu_0 \epsilon_0 \frac{\partial}{\partial t} \left( n^2 \frac{\partial A_z}{\partial t} \right) + \nabla \cdot (\nabla A_z) = 0$$

When using the refractive index, the assumption is that  $\mu_r = 1$  and  $\sigma = 0$  and only the constitutive relations for linear materials can be used.

### *Axisymmetric Hybrid-Mode Waves*

Solving for all three components in 2D is referred to as “hybrid-mode waves”. The equation form is formally the same as in 3D with the addition that spatial derivatives with respect to  $\phi$  are set to zero.

### *Axisymmetric TM Waves*

TM waves have a magnetic field with only a  $\phi$  component and thus an electric field and a magnetic vector potential with components in the  $rz$ -plane only. The equation is formally the same as in 3D, the only difference being that the  $\phi$  component is zero everywhere and that spatial derivatives with respect to  $\phi$  are set to zero.

### *Axisymmetric TE Waves*

A TE wave has only a vector potential component in the  $\phi$  direction, and the magnetic field lies in the modeling plane. Given these constraints, the 3D equation can be simplified to a scalar equation for  $A_\phi$ . To write the fields in this form, it is also required

that  $\epsilon_r$  and  $\mu_r$  are nondiagonal only in the  $rz$ -plane.  $\mu_r$  denotes a 2-by-2 tensor, while  $\epsilon_{r\phi\phi}$  and  $\sigma_{\phi\phi}$  are the relative permittivity and conductivity in the  $\phi$  direction.

### *Curl Elements*

---

Whenever solving for more than a single vector component, it is not possible to use Lagrange elements for electromagnetic wave modeling. The reason is that they force the fields to be continuous everywhere. This implies that the physics interface conditions, which specify that the normal components of the electric fields and the tangential components of the magnetic fields are discontinuous across interior boundaries between media with different permittivity and permeability, cannot be fulfilled. To overcome this problem, the Electromagnetic Waves, Frequency Domain interface uses *curl elements*, which do not have this limitation. The curl element is also named as vector element or edge element.

The solution obtained when using curl elements also better fulfills the divergence conditions  $\nabla \cdot \mathbf{D} = 0$  and  $\nabla \cdot \mathbf{B} = 0$  than when using Lagrange elements.



For more information about the curl element, read the blog post:  
[www.comsol.com/blogs/what-is-the-curl-element-and-why-is-it-used/](http://www.comsol.com/blogs/what-is-the-curl-element-and-why-is-it-used/)

---

### *Eigenfrequency Calculations*

---

When making eigenfrequency calculations, there are a few important things to note:

- Nonlinear eigenvalue problems appear for impedance boundary conditions with nonzero conductivity and for *scattering boundary conditions* adjacent to domains with nonzero conductivity. Such problems have to be treated specially.
- Some of the boundary conditions, such as the surface current density condition and the electric field condition, can specify a source in the eigenvalue problem. These conditions are available as a general tool to specify arbitrary expressions between the  $\mathbf{H}$  field and the  $\mathbf{E}$  field. Avoid specifying solution-independent sources for these conditions because the eigenvalue solver ignores them anyway.

Using the default parameters for the eigenfrequency study, it might find a large number of false eigenfrequencies, which are almost zero. This is a known consequence of using vector elements. To avoid these eigenfrequencies, change the parameters for the eigenvalue solver in the **Study Settings**. Adjust the settings so that the solver searches for eigenfrequencies closer to the lowest eigenfrequency than to zero.

## Gaussian Beams as Background Fields and Input Fields

---

When solving for the scattered field, the background wave type can be set to a predefined Gaussian beam from within the **Settings** of [The Electromagnetic Waves, Frequency Domain Interface](#). Additionally, Gaussian beams can be specified as the input field for the [Scattering Boundary Condition](#).

In the paraxial approximation, the field for a Gaussian beam propagating along the  $z$ -axis is

$$\mathbf{E}_G(x, y, z) = \mathbf{E}_{G0} \frac{w_0}{w(z)} \exp \left[ -\frac{\rho^2}{w^2(z)} - jkz - jk \frac{\rho^2}{2R(z)} + j\eta(z) \right],$$

where  $w_0$  is the beam radius,  $p_0$  is the focal plane on the  $z$ -axis,  $\mathbf{E}_{G0}$  is the Gaussian beam electric field amplitude, and the spot radius for different positions along the propagation axis is given by

$$w(z) = w_0 \sqrt{1 + \left( \frac{z - p_0}{z_0} \right)^2}.$$

$$R(z) = (z - p_0) \left[ 1 + \left( \frac{z_0}{z - p_0} \right)^2 \right]$$

defines the radius of curvature for the phase of the field and the so-called Gouy phase shift is given by

$$\eta(z) = \text{atan} \left( \frac{z - p_0}{z_0} \right).$$

The equations above are expressed using the Rayleigh range  $z_0$  and the transverse coordinate  $\rho$ , defined by

$$z_0 = \frac{kw_0^2}{2}, \rho^2 = x^2 + y^2.$$

Note that the time-harmonic ansatz in COMSOL Multiphysics is  $e^{j\omega t}$ , and with this convention, the beam above propagates in the  $+z$  direction. The equations are modified accordingly for beams propagating along the other coordinate axes.

The field for a Gaussian beam is defined in a similar way for 2D components. In the particular case where the beam propagates along the  $x$ -axis, the field is defined as

$$\mathbf{E}_G(x, y) = \mathbf{E}_{G0} \sqrt{\frac{w_0}{w(x)}} \exp \left[ -\frac{y^2}{w^2(x)} - jkx - jk \frac{y^2}{2R(x)} + j \frac{\eta(x)}{2} \right].$$

For a beam propagating along the  $y$ -axis, the coordinates  $x$  and  $y$  are interchanged.

Notice that the expressions above for Gaussian beams are not solutions to the Helmholtz equation, but to the so called paraxial approximation of the Helmholtz equation. This means that these equations become less accurate the smaller the spot radius is and should not be used when the spot radius is of the same size as or smaller than the wavelength.

To circumvent the problem that the paraxial approximation formula is not a solution to the Helmholtz equation, a plane wave expansion can be used to approximate a Gaussian beam *background field*. Since each plane wave is a solution to Helmholtz equation, also the expansion is a solution to Helmholtz equation.

The plane wave expansion approximates the Gaussian distribution in the focal plane

$$\begin{aligned} \mathbf{E}_{b, \text{Gauss}}(\mathbf{r}) &= E_0 \exp \left( -\frac{x^2 + y^2}{w_0^2} \right) \mathbf{e} = \\ &= \sum_{l=-L}^L \sum_{m=-M}^M \sum_{n=1}^1 a_{lmn} \mathbf{u}_n(\mathbf{k}_{lm}) \exp(-i\mathbf{k}_{lm} \cdot \mathbf{r}), \end{aligned}$$

where the beam is assumed to be propagating in the  $z$  direction, the focal plane is spanned by the  $x$ - and  $y$ -coordinates,  $\mathbf{e}$  is the unit magnitude transverse polarization in the focal plane,  $l$  and  $m$  denote the indices for the wave vectors, the index  $n$  accounts for the two polarizations per wave vector  $\mathbf{k}_{lm}$ ,  $a_{lmn}$  is the amplitude,  $\mathbf{u}_n(\mathbf{k}_{lm})$  is the unit magnitude polarization, and  $\mathbf{r}$  is the position vector.

Multiplying with the conjugate of the exponential factor above and the polarization factor  $\mathbf{u}_n(\mathbf{k}_{lm})$  and applying a surface integral over the entire focal plane allows us to extract the amplitudes as

$$a_{lmn} = \frac{E_0 w_0^2 (\mathbf{e} \cdot \mathbf{u}_n(\mathbf{k}_{lm}))}{4\pi} \exp \left( -\frac{k_{t,lm}^2 w_0^2}{4} \right),$$

where  $k_{t,lm}$  is the magnitude of the transverse wave vector component.

## *Linearly Polarized Plane Wave as Background Field in 2D Axisymmetry*

---

When solving for the scattered field in 2D axisymmetry, the background wave type can be set to a linearly polarized plane wave propagating in arbitrary direction in the **Settings** of [The Electromagnetic Waves, Frequency Domain Interface](#). The linearly polarized plane wave is of the form  $\mathbf{E}_b = \mathbf{E}_0 e^{j(\omega t - (\mathbf{k} \cdot \mathbf{r}))}$ . In Cartesian coordinates,  $\mathbf{E}_0 = (E_x, E_y, E_z)$ ,  $\mathbf{k} = (k_x, k_y, k_z)$ , and  $\mathbf{r} = (x, y, z)$ . To express a linearly polarized plane wave with arbitrary incident angle and polarization angle in cylindrical coordinates for a 2D axisymmetric simulation, use the following expansions:

$$e^{-jkr \sin \theta \cos \phi} = \sum_{m=-\infty}^{\infty} (-j)^m J_m(kr \sin \theta) e^{-jm\phi},$$

where  $\theta$  is the angle with respect to the positive  $z$ -axis,  $\phi$  is the azimuthal angle,  $m$  is the azimuthal mode number, and  $J_m$  is the Bessel function of the first kind of order  $m$ . Furthermore, the basis vectors  $\hat{\mathbf{x}}$  and  $\hat{\mathbf{y}}$  in Cartesian coordinates can be expressed with basis vectors  $\hat{\mathbf{r}}$  and  $\hat{\phi}$  as

$$\hat{\mathbf{x}} = \frac{1}{2} [e^{j\phi}(\hat{\mathbf{r}} + j\hat{\phi}) + e^{-j\phi}(\hat{\mathbf{r}} - j\hat{\phi})]$$

and

$$\hat{\mathbf{y}} = \frac{1}{2} [e^{j\phi}(\hat{\phi} - j\hat{\mathbf{r}}) + e^{-j\phi}(\hat{\phi} + j\hat{\mathbf{r}})].$$

Consequently, a plane wave background field with amplitude  $E_0$ , incident angle  $\theta$ , and polarization angle  $\alpha$  can be written as  $(E_r, E_\phi, E_z)$ , where

$$\begin{aligned} E_r = & \frac{E_0}{2} e^{jkz \cos \theta} \sum_{m=-\infty}^{\infty} [(\cos \alpha \cos \theta - j \sin \alpha)(-j)^{m+1} J_{m+1}(kr \sin \theta) \\ & + (\cos \alpha \cos \theta + j \sin \alpha)(-j)^{m-1} J_{m-1}(kr \sin \theta)] e^{-jm\phi}, \end{aligned}$$

$$E_\phi = \frac{E_0}{2} e^{jkz \cos \theta} \sum_{m=-\infty}^{\infty} [(\sin \alpha + j \cos \alpha \cos \theta)(-j)^{m+1} J_{m+1}(kr \sin \theta) + (\sin \alpha - j \cos \alpha \cos \theta)(-j)^{m-1} J_{m-1}(kr \sin \theta)] e^{-jm\phi},$$

and

$$E_z = E_0 \cos \alpha \sin \theta e^{jkz \cos \theta} \sum_{m=-\infty}^{\infty} (-j)^m J_m(kr \sin \theta) e^{-jm\phi}.$$

Here,  $\theta$  and  $\alpha$  are defined as the schematic shown in [Figure 4-2](#). Once the linearly polarized plane wave is used as the background field, an auxiliary sweep over the azimuthal mode number will be added. After the simulation, the total scattered field is given by the sum of all the azimuthal modes. The  $z$ -components of the scattered field and the background field will be plotted by default. Other components of the field can be computed in a similar way with the help of the `sum` and `withsol` operators.

### *Periodic Port Mode Fields*

---

[Periodic](#), [Diffraction Order](#), and [Orthogonal Polarization Port](#) features, all use plane-wave electric mode fields of the form

$$\mathbf{E} = \mathbf{E}_m \exp(-j\mathbf{k}_m \cdot \mathbf{r}),$$

where  $\mathbf{E}_m$ ,  $\mathbf{k}_m$ , and  $\mathbf{r}$  are the amplitude, the wave vector, and the position vector, respectively. Here,  $m$  is the mode index. Since, this field represents a plane wave, the amplitude must be orthogonal to the wave vector,

$$\mathbf{E}_m \cdot \mathbf{k}_m = 0.$$

As plane-wave mode fields are assumed, the material properties in the domain adjacent to the port boundary must be homogeneous and isotropic.

For the [Periodic Port](#), the amplitude  $\mathbf{E}_0$  is provided by the user (we set  $m = 0$  here, as the [Periodic Port](#) represents the lowest diffraction order). The amplitude for the [Orthogonal Polarization Port](#) is orthogonal to the amplitude of the [Periodic Port](#). That is,

$$\mathbf{E}_{\text{orth}} \cdot \text{conj}(\mathbf{E}_0) = 0.$$

For **Diffraction Order** ports, the amplitude for out-of-plane modes is calculated as

$$\mathbf{E}_{m,oop} = \mathbf{k}_m \times \mathbf{n},$$

where  $\mathbf{n}$  is the port normal.

For normal incidence,  $\mathbf{k}_m$  is parallel to  $\mathbf{n}$ . Then the amplitude is defined by a tangent vector to the port boundary.

For in-plane modes, the amplitude is defined by

$$\mathbf{E}_{m,ip} = \mathbf{E}_{m,oop} \times \mathbf{k}_m.$$

From the amplitude definitions above, it is clear that in-plane modes are polarized in the plane spanned by the port normal  $\mathbf{n}$  and the mode wave vector  $\mathbf{k}_m$ , whereas out-of-plane modes have a polarization that is orthogonal to this plane.

The mode fields described above are the unnormalized mode fields. The normalized mode fields are scaled to produce a mode power that equals the specified port input power (for excited ports) or 1 W for listener ports.

### *Effective Material Properties in Effective Media and Mixtures*

---

One way of dealing with effective media or mixtures of solids in electromagnetic models is to replace them with an homogenized medium. The electric and magnetic properties of this medium are computed from the properties of each phase by means of an averaging formula.

There are several possible approaches to compute an average material property starting from the material properties and the volume fraction of each material.

The following sections illustrate the different formulas available to compute the *effective electrical conductivity*, the *effective relative permittivity*, and the *effective relative permeability* of a homogenized medium. In the following, volume fractions of the materials are indicated with  $\theta_i$ , where  $i$  is the material index, and they are assumed to be fractional (between 0 and 1). Up to five different materials can be specified as phases of the mixture. Typically, their volume fractions should add up to 1.

### *Effective Conductivity in Effective Media and Mixtures*

---

Three methods are available to compute the averaged electrical conductivity of the mixture.

### VOLUME AVERAGE, CONDUCTIVITY

If the electric conductivities of the two materials are not so different from each other, a simple form of averaging can be used, such as a volume average:

$$\sigma = \sum_{i=1}^n \theta_i \sigma_i = \theta_1 \sigma_1 + \theta_2 \sigma_2 + \dots$$

where  $\sigma_i$  is the conductivity of the material  $i$ . This is equivalent to a “parallel” system of resistivities.

If the conductivities are defined by second order tensors (such as for anisotropic materials), the volume average is applied element by element.

### VOLUME AVERAGE, RESISTIVITY

A similar expression for the effective conductivity can be used, which mimics a “series” connection of resistivities. Equivalently, the effective conductivity is obtained from

$$\frac{1}{\sigma} = \sum_{i=0}^n \frac{\theta_i}{\sigma_i} = \frac{\theta_1}{\sigma_1} + \frac{\theta_2}{\sigma_2} + \dots$$

If the conductivities are defined by second order tensors, the inverse of the tensors are used.

### POWER LAW

A power law gives the following expression for the equivalent conductivity:

$$\sigma = \prod_{i=0}^n \sigma_i^{\theta_i} = \sigma_1^{\theta_1} \sigma_2^{\theta_2} \dots$$

The effective conductivity calculated by [Volume Average, Conductivity](#) is the upper bound, the effective conductivity calculated by [Volume Average, Resistivity](#) is the lower bound, and the [Power Law](#) average is somewhere between these two.

---

### *Effective Relative Permittivity in Effective Media and Mixtures*

Three methods are available to compute the averaged electrical conductivity of the mixture.



### VOLUME AVERAGE, PERMITTIVITY

If the relative permittivity of the two materials is not so different from each other, the effective relative permittivity  $\varepsilon_r$  is calculated by simple volume average:

$$\varepsilon = \sum_{i=1}^n \theta_i \varepsilon_i = \theta_1 \varepsilon_1 + \theta_2 \varepsilon_2 + \dots$$

where  $\varepsilon_i$  is the relative permeability of the material  $i$ .

If the permittivity is defined by second-order tensors (such as for anisotropic materials), the volume average is applied element by element.

### VOLUME AVERAGE, RECIPROCAL PERMITTIVITY

The second method is the volume average of the inverse of the permittivities:

$$\frac{1}{\varepsilon} = \sum_{i=0}^n \frac{\theta_i}{\varepsilon_i} = \frac{\theta_1}{\varepsilon_1} + \frac{\theta_2}{\varepsilon_2} + \dots$$

If the permittivity is defined by a second-order tensor, the inverse of the tensor is used.

### POWER LAW

A power law gives the following expression for the equivalent permittivity:

$$\varepsilon = \prod_{i=0}^n \varepsilon_i^{\theta_i} = \varepsilon_1^{\theta_1} \varepsilon_2^{\theta_2} \dots$$

The effective permeability calculated by [Volume Average, Permittivity](#) is the upper bound, the effective permeability calculated by [Volume Average, Reciprocal Permittivity](#) is the lower bound, and the [Power Law](#) average gives a value somewhere between these two.

### *Effective Relative Permeability in Effective Media and Mixtures*

---

Three methods are available to compute the averaged electrical conductivity of the mixture.

### VOLUME AVERAGE, PERMEABILITY

If the relative permeability of the two materials is not so different from each other, the effective relative permeability  $\mu_r$  is calculated by simple volume average:

$$\mu = \sum_{i=1}^n \theta_i \mu_i = \theta_1 \mu_1 + \theta_2 \mu_2 + \dots$$

where  $\mu_i$  is the relative permeability of the material  $i$ .

If the permeability is defined by second-order tensors (such as for anisotropic materials), the volume average is applied element by element.

### VOLUME AVERAGE, RECIPROCAL PERMEABILITY

The second method is the volume average of the inverse of the permeabilities:

$$\frac{1}{\mu} = \sum_{i=0}^n \frac{\theta_i}{\mu_i} = \frac{\theta_1}{\mu_1} + \frac{\theta_2}{\mu_2} + \dots$$

If the permeability is defined by a second-order tensor, the inverse of the tensor is used.

### POWER LAW

A power law gives the following expression for the equivalent permeability:

$$\mu = \prod_{i=0}^n \mu_i^{\theta_i} = \mu_1^{\theta_1} \mu_2^{\theta_2} \dots$$

The effective permeability calculated by [Volume Average, Permeability](#) is the upper bound, the effective permeability calculated by [Volume Average, Reciprocal Permeability](#) is the lower bound, and the [Power Law](#) average gives a value somewhere between these two.

### *Archie's Law Theory*

---

The electrical conductivity of the materials composing saturated rocks and soils can vary over many orders of magnitude. For instance, in the petroleum reservoirs, normal sea water (or brine) has a typical conductivity of around 3 S/m, whereas hydrocarbons are typically much more resistive and have conductivities in the range 0.1–0.01 S/m.

The porous rocks and sediments can have even lower conductivities. In variably saturated soils, the conductivity of air is roughly ten orders of magnitude lower than the ground water. A simple volume average (of either conductivity or resistivity) in rocks or soils might give different results compared to experimental data.

Since most crustal rocks, sedimentary rocks, and soils are formed by nonconducting materials, Archie (Ref. 1) assumed that electric current are mainly caused by ion fluxes through the pore network. Originally, Archie's law is an empirical law for the effective conductivity of a fully saturated rock or soil, but it can be extended to variably saturated porous media.

Archie's law relates the effective conductivity to the fluid conductivity  $\sigma_L$ , fluid saturation  $s_L$ , and porosity  $\epsilon_p$ :

$$\sigma = s_L^n \epsilon_p^m \sigma_L$$

here,  $m$  is the cementation exponent, a parameter that describes the connectivity of the pores. The cementation exponent normally varies between 1.3 and 2.5 for most sedimentary rocks and is close to 2 for sandstones. The lower limit  $m = 1$  represents a volume average of the conductivities of a fully saturated, insulating (zero conductivity) porous matrix, and a conducting fluid. The saturation coefficient  $n$  is normally close to 2. The ratio  $F = \sigma_L/\sigma$  is called the *formation factor*.

Archie's law does not take care of the relative permittivity of either fluids or solids, so the effective relative permittivity of the porous medium is normally consider as  $\epsilon_r = 1$ .

### *Reference for Archie's Law*

---

1. G.E. Archie, "The Electric Resistivity as an Aid in Determining Some Reservoir Characteristics," *Trans. Am. Inst. Metal. Eng.*, vol. 146, pp. 54–62, 1942.

# Theory for the Transmission Line Interface

The [Transmission Line Interface](#) theory is described in this section.

- [Introduction to Transmission Line Theory](#)
- [Theory for the Transmission Line Boundary Conditions](#)

## *Introduction to Transmission Line Theory*

---

[Figure 4-9](#) is an illustration of a transmission line of length  $L$ . The distributed resistance  $R$ , inductance  $L$ , conductance  $G$ , and capacitance  $C$ , characterize the properties of the transmission line.

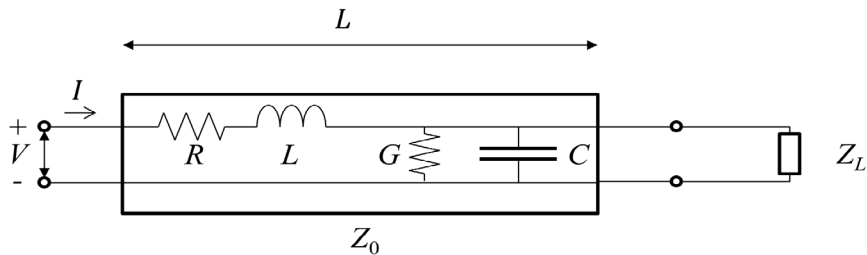

*Figure 4-9: Schematic of a transmission line with a load impedance.*

The distribution of the electric potential  $V$  and the current  $I$  describes the propagation of the signal wave along the line. The following equations relate the current and the electric potential

$$\frac{\partial V}{\partial x} = -(R + j\omega L)I \quad (4-1)$$

$$\frac{\partial I}{\partial x} = -(G + j\omega C)V \quad (4-2)$$

[Equation 4-1](#) and [Equation 4-2](#) can be combined to the second-order partial differential equation

$$\frac{\partial^2 V}{\partial x^2} = \gamma^2 V \quad (4-3)$$

where

$$\gamma = \sqrt{(R + j\omega L)(G + j\omega C)} = \alpha + j\beta$$

Here  $\gamma$ ,  $\alpha$ , and  $\beta$  are called the complex propagation constant, the attenuation constant, and the (real) propagation constant, respectively.



The attenuation constant,  $\alpha$ , is zero if  $R$  and  $G$  are zero.

The solution to [Equation 4-3](#) represents a forward- and a backward-propagating wave

$$V(x) = V_+ e^{-\gamma x} + V_- e^{\gamma x} \quad (4-4)$$

By inserting [Equation 4-4](#) in [Equation 4-1](#) the current distribution is obtained.

$$I(x) = \frac{\gamma}{R + j\omega L} (V_+ e^{-\gamma x} - V_- e^{\gamma x})$$

If only a forward-propagating wave is present in the transmission line (no reflections), dividing the voltage by the current gives the characteristic impedance of the transmission line

$$Z_0 = \frac{V}{I} = \frac{R + j\omega L}{\gamma} = \sqrt{\frac{R + j\omega L}{G + j\omega C}}$$

To make sure that the current is conserved across interior boundaries, COMSOL Multiphysics solves the following wave equation (instead of [Equation 4-3](#))

$$\frac{\partial}{\partial x} \left( \frac{1}{R + j\omega L} \frac{\partial V}{\partial x} \right) - (G + j\omega C)V = 0 \quad (4-5)$$

### *Theory for the Transmission Line Boundary Conditions*

The [Transmission Line Interface](#) has these boundary conditions:

$$V_1 = V_2 \quad (4-6)$$

and

$$I_1 = I_2 \quad (4-7)$$

In Equation 4-6 and Equation 4-7, the indices 1 and 2 denote the domains on the two sides of the boundary. The currents flowing out of a boundary are given by

$$I_i = -\frac{\mathbf{n}_i \cdot \nabla V_i}{R_i + j\omega L_i}, \quad i = 1, 2$$

where  $\mathbf{n}_i$  are the normals pointing out of the domain.

Because  $V$  is solved for, the electric potential is always continuous, and thus Equation 4-6 is automatically fulfilled. Equation 4-7 is equivalent to the natural boundary condition

$$\frac{1}{R_2 + j\omega L_2} \frac{\partial V}{\partial x} \Big|_2 - \frac{1}{R_1 + j\omega L_1} \frac{\partial V}{\partial x} \Big|_1 = 0$$

which is fulfilled with the wave-equation formulation in Equation 4-5.

When the transmission line is terminated by a load impedance, as Figure 4-9 shows, the current through the load impedance is given by

$$I(L) = \frac{V(L)}{Z_L} \quad (4-8)$$

Inserting Equation 4-1 into Equation 4-8, results in the Terminating Impedance boundary condition

$$\frac{1}{R + j\omega L} \frac{\partial V}{\partial x} + \frac{V}{Z_L} = 0 \quad (4-9)$$

If the arbitrary load impedance  $Z_L$  is replaced by the characteristic impedance of the transmission line  $Z_0$  you get the Absorbing Boundary condition. By inserting the voltage, defined in Equation 4-4, in Equation 4-9 you can verify that the boundary condition does not allow any reflected wave (that is,  $V$  is zero).

The Open Circuit boundary condition is obtained by letting the load impedance become infinitely large, that is, no current flows through the load impedance.

On the other hand, the Short Circuit boundary condition specifies that the voltage at the load is zero. In COMSOL Multiphysics this is implemented as a constraint on the electric potential.

To excite the transmission line, use the [Incoming Wave](#) boundary condition. Referring to the left (input) end of the transmission line in [Figure 4-9](#), the forward propagating wave has a voltage amplitude of  $V_0$ . Thus, the total voltage at this boundary is given by

$$V(0) = V = V_0 + V_+$$

Thereby, the current can be written as

$$I(0) = -\frac{1}{R + j\omega L} \frac{\partial V}{\partial x} \Big|_{x=0} = \frac{1}{Z_0} (V_0 - V_+) = \frac{2V_0 - V}{Z_0}$$

resulting in the boundary condition

$$-\frac{1}{R + j\omega L} \frac{\partial V}{\partial x} + \frac{V - 2V_0}{Z_0} = 0$$

For the [Lumped Port](#) boundary condition, the port current (positive when entering the transmission line) defines the boundary condition as

$$-\frac{1}{R + j\omega L} \frac{\partial V}{\partial x} - I_{\text{port}} = 0$$

where the port current  $I_{\text{port}}$  is given by

$$I_{\text{port}} = \frac{2V_0 - V}{Z_0}$$

for a Cable lumped port (see the [Lumped Port](#) section for a description of the lumped port settings).

For a Current-controlled lumped port, you provide  $I_{\text{port}}$  as an input parameter, whereas it is part of an electrical circuit equation for a Circuit-based lumped port.

# Theory for the Electromagnetic Waves, Time Explicit Interface

The Electromagnetic Waves, Time Explicit Interface theory is described in this section:

- [The Equations](#)
- [In-Plane E Field or In-Plane H Field](#)
- [Fluxes as Dirichlet Boundary Conditions](#)
- [Absorbing Layers](#)

## *The Equations*

---

Maxwell's equations are a set of equations, written in differential or integral form, stating the relationships between the fundamental electromagnetic quantities. These quantities are the:

- Electric field intensity  $\mathbf{E}$
- Electric displacement or electric flux density  $\mathbf{D}$
- Magnetic field intensity  $\mathbf{H}$
- Magnetic flux density  $\mathbf{B}$
- Current density  $\mathbf{J}$
- Electric charge density  $\rho$

For general time-varying fields, the differential form of Maxwell's equations can be written as

$$\begin{aligned}\nabla \times \mathbf{H} &= \mathbf{J} + \frac{\partial \mathbf{D}}{\partial t} \\ \nabla \times \mathbf{E} &= -\frac{\partial \mathbf{B}}{\partial t} \\ \nabla \cdot \mathbf{D} &= \rho \\ \nabla \cdot \mathbf{B} &= 0\end{aligned}\tag{4-10}$$

The first two equations are also called Maxwell-Ampère's law and Faraday's law, respectively. Equation three and four are two forms of Gauss' law, the electric and magnetic form, respectively.



## CONSTITUTIVE RELATIONS

To obtain a closed system of equations, the constitutive relations describing the macroscopic properties of the medium are included. These are given as

$$\begin{aligned}\mathbf{D} &= \varepsilon_0 \mathbf{E} + \mathbf{P} \\ \mathbf{B} &= \mu_0 (\mathbf{H} + \mathbf{M}) \\ \mathbf{J} &= \sigma \mathbf{E}\end{aligned}\tag{4-11}$$

Here  $\varepsilon_0$  is the permittivity of a vacuum,  $\mu_0$  is the permeability of a vacuum, and  $\sigma$  the electric conductivity of the medium. In the SI system, the permeability of a vacuum is chosen to be  $4\pi \cdot 10^{-7}$  H/m. The velocity of an electromagnetic wave in a vacuum is given as  $c_0$  and the permittivity of a vacuum is derived from the relation

$$\varepsilon_0 = \frac{1}{c_0^2 \mu_0} = 8.854 \cdot 10^{-12} \text{ F/m} \approx \frac{1}{36\pi} \cdot 10^{-9} \text{ F/m}$$

The electric polarization vector  $\mathbf{P}$  describes how the material is polarized when an electric field  $\mathbf{E}$  is present. It can be interpreted as the volume density of electric dipole moments.  $\mathbf{P}$  is generally a function of  $\mathbf{E}$ . Some materials might have a nonzero  $\mathbf{P}$  also when there is no electric field present.

The magnetization vector  $\mathbf{M}$  similarly describes how the material is magnetized when a magnetic field  $\mathbf{H}$  is present. It can be interpreted as the volume density of magnetic dipole moments.  $\mathbf{M}$  is generally a function of  $\mathbf{H}$ . Permanent magnets, for example, have a nonzero  $\mathbf{M}$  also when there is no magnetic field present.

To get a wave equation for the  $\mathbf{E}$  field, for example, take the curl of the second equation in [Equation 4-10](#) (previously divided by  $\mu_0$ ), and insert it into the time derivative of the first row in [Equation 4-10](#)

$$-\nabla \times \left( \frac{1}{\mu_0} \nabla \times \mathbf{E} + \frac{\partial \mathbf{M}}{\partial t} \right) = \sigma \frac{\partial \mathbf{E}}{\partial t} + \varepsilon_0 \frac{\partial^2 \mathbf{E}}{\partial t^2} + \frac{\partial^2 \mathbf{P}}{\partial t^2}$$

this is referred as curl-curl formulation in the literature (second order time derivatives and second order space derivatives).

## LINEAR MATERIALS

In the simplest case linear materials, the polarization is directly proportional to the electric field, that is

$$\partial \mathbf{P} / \partial \mathbf{E} = \varepsilon_0 \chi_e \quad \text{and} \quad \mathbf{P} = \varepsilon_0 \chi_e \mathbf{E}$$

where  $\chi_e$  is the electric susceptibility (which can be a scalar or a second-rank tensor). Similarly, the magnetization is directly proportional to the magnetic field, or

$$\partial \mathbf{M} / \partial \mathbf{H} = \chi_m \text{ and } \mathbf{M} = \chi_m \mathbf{H}$$

where  $\chi_m$  is the magnetic susceptibility.

As a consequence, for linear materials, the constitutive relations in Equation 4-11 can be written as

$$\begin{aligned} \mathbf{D} &= \epsilon_0 \mathbf{E} + \mathbf{P} = \epsilon_0(1 + \chi_e) \mathbf{E} = \epsilon_0 \epsilon_r \mathbf{E} \\ \mathbf{B} &= \mu_0(\mathbf{H} + \mathbf{M}) = \mu_0(1 + \chi_m) \mathbf{H} = \mu_0 \mu_r \mathbf{H} \end{aligned}$$

Here,  $\epsilon = \epsilon_0 \epsilon_r$  and  $\mu = \mu_0 \mu_r$  are the permittivity and permeability of the material. The relative permittivity  $\epsilon_r$  and the relative permeability  $\mu_r$  are usually scalar properties but these can be second-rank symmetric (Hermitian) tensors for a general anisotropic material.

For general time-varying fields, Maxwell's equations in linear materials described in Equation 4-10 can be simplified to Maxwell-Ampère's law and Faraday's law:

$$\begin{aligned} \nabla \times \mathbf{H} &= \sigma \mathbf{E} + \epsilon_0 \epsilon_r \frac{\partial \mathbf{E}}{\partial t} \\ \nabla \times \mathbf{E} &= -\mu_0 \mu_r \frac{\partial \mathbf{H}}{\partial t} \end{aligned} \quad (4-12)$$

The electric conductivity  $\sigma$  can also be a scalar or a second-rank tensor. Another important assumption is that the relative permittivity  $\epsilon_r$ , the relative permeability  $\mu_r$  and the electric conductivity  $\sigma$  might change with position and orientation (inhomogeneous or anisotropic materials) but not with time.

#### FIRST-ORDER IMPLEMENTATION OF MAXWELL'S EQUATIONS

In order to accommodate Maxwell's equations in the coefficients for the Wave Form PDE interface in the form

$$d_a \frac{\partial \mathbf{u}}{\partial t} + \nabla \cdot \Gamma(\mathbf{u}) = \mathbf{f}$$

the curl of a vector is written in divergence form as

$$\nabla \times \mathbf{u} = \nabla \cdot \begin{bmatrix} 0 & u_3 & -u_2 \\ -u_3 & 0 & u_1 \\ u_2 & -u_1 & 0 \end{bmatrix} \quad (4-13)$$

where the divergence is applied on each row of the flux  $\Gamma(\mathbf{u})$ .

Maxwell's equations in 3D

$$\begin{aligned} \epsilon_0 \epsilon_r \frac{\partial \mathbf{E}}{\partial t} - \nabla \times \mathbf{H} &= -\sigma \mathbf{E} \\ \mu_0 \mu_r \frac{\partial \mathbf{H}}{\partial t} + \nabla \times \mathbf{E} &= \mathbf{0} \end{aligned}$$

are then accommodated to the Wave Form PDE as

$$\begin{aligned} d_E \frac{\partial \mathbf{E}}{\partial t} + \nabla \cdot \Gamma_E(\mathbf{H}) &= \mathbf{f} \\ d_H \frac{\partial \mathbf{H}}{\partial t} + \nabla \cdot \Gamma_H(\mathbf{E}) &= \mathbf{0} \end{aligned}$$

with the “mass” coefficients

$$d_E = \epsilon_0 \epsilon_r \quad \text{and} \quad d_H = \mu_0 \mu_r$$

the “flux” terms

$$\Gamma_E(\mathbf{H}) = - \begin{bmatrix} 0 & h_3 & -h_2 \\ -h_3 & 0 & h_1 \\ h_2 & -h_1 & 0 \end{bmatrix} \quad \text{and} \quad \Gamma_H(\mathbf{E}) = \begin{bmatrix} 0 & e_3 & -e_2 \\ -e_3 & 0 & e_1 \\ e_2 & -e_1 & 0 \end{bmatrix}$$

and the “source” term  $\mathbf{f} = -\sigma \mathbf{E}$ .

#### THE LAX-FRIEDRICHS FLUX PARAMETERS



When using SI units (or other) for the electromagnetic fields and material properties, the Lax-Friedrichs flux parameter is not dimensionless and must have units of  $\tau_E = 1/(2Z)$  for Ampère's law and  $\tau_H = Z/2$  for Faraday's law, where  $Z$  is the impedance of the medium.

### *In-Plane E Field or In-Plane H Field*

---

In the general case, in 2D and 2D axisymmetric, solving for three variables for each field is still required. The “in-plane H” or “in-plane E” assumption simplifies the problem to only three dependent variables.

#### **TM WAVES IN 2D**

For TM waves in 2D, solve for an in-plane electric field vector and one out-of-plane variable for the magnetic field. Maxwell’s equations then read

$$\begin{aligned}\varepsilon_0 \varepsilon_r \frac{\partial \mathbf{E}}{\partial t} + \nabla \cdot \Gamma_E(\mathbf{H}) &= -\sigma \cdot \mathbf{E} \\ \mu_0 \mu_r \frac{\partial \mathbf{H}}{\partial t} + \nabla \cdot \Gamma_H(\mathbf{E}) &= 0\end{aligned}\tag{4-14}$$

with the flux terms

$$\Gamma_E(\mathbf{H}) = \begin{bmatrix} 0 & -h_3 \\ h_3 & 0 \end{bmatrix} \text{ and } \Gamma_H(\mathbf{E}) = \begin{bmatrix} e_2 & -e_1 \end{bmatrix}\tag{4-15}$$

The divergence on  $\Gamma_E(\mathbf{H})$  is applied row-wise. The conductivity and permittivity tensors  $\sigma$  and  $\varepsilon_r$  represent in-plane material properties, while the relative permeability  $\mu_r$  is an out-of-plane scalar property.

The default Lax-Friedrichs flux parameters are  $\tau_E = 1/(2Z)$  for Ampère’s law, and the scalar  $\tau_H = Z/2$  for Faraday’s law, where  $Z$  is the impedance of a vacuum.

#### **TE WAVES IN 2D**

For TE waves in 2D, solve for an in-plane magnetic field vector and one out-of-plane variable for the electric field. Maxwell’s equations then read

$$\begin{aligned}\varepsilon_0 \varepsilon_r \frac{\partial \mathbf{E}}{\partial t} + \nabla \cdot \Gamma_E(\mathbf{H}) &= -\sigma \mathbf{E} \\ \mu_0 \mu_r \frac{\partial \mathbf{H}}{\partial t} + \nabla \cdot \Gamma_H(\mathbf{E}) &= 0\end{aligned}\tag{4-16}$$

with the flux terms

$$\Gamma_E(\mathbf{H}) = \begin{bmatrix} -h_2 & h_1 \end{bmatrix} \text{ and } \Gamma_H(\mathbf{E}) = \begin{bmatrix} 0 & e_3 \\ -e_3 & 0 \end{bmatrix}\tag{4-17}$$

The divergence of  $\Gamma_H(\mathbf{E})$  is applied row-wise. The tensor of relative permeability  $\mu_r$  represents in-plane material properties, while the relative permittivity  $\epsilon_r$  and conductivity  $\sigma$  are out-of-plane scalar properties.

The default Lax-Friedrichs flux parameters are  $\tau_E = 1/(2Z)$  for Ampère's law, and two scalar  $\tau_H = Z/2$  for Faraday's law, where  $Z$  is the impedance of a vacuum.

### *Fluxes as Dirichlet Boundary Conditions*

---

Consider Maxwell's equations in 3D

$$\epsilon_0 \epsilon_r \frac{\partial \mathbf{E}}{\partial t} + \nabla \cdot \Gamma_E(\mathbf{H}) = -\sigma \mathbf{E}$$

$$\mu_0 \mu_r \frac{\partial \mathbf{H}}{\partial t} + \nabla \cdot \Gamma_H(\mathbf{E}) = \mathbf{0}$$

with the flux terms

$$\Gamma_E(\mathbf{H}) = \begin{bmatrix} 0 & -h_3 & h_2 \\ h_3 & 0 & -h_1 \\ -h_2 & h_1 & 0 \end{bmatrix} \text{ and } \Gamma_H(\mathbf{E}) = \begin{bmatrix} 0 & e_3 & -e_2 \\ -e_3 & 0 & e_1 \\ e_2 & -e_1 & 0 \end{bmatrix}$$

and the divergence on  $\Gamma_E(\mathbf{H})$  and  $\Gamma_H(\mathbf{E})$  applied row-wise.

For Ampère's law, the normal to the flux term on exterior boundaries reads

$$\mathbf{n} \cdot \Gamma_E(\mathbf{H}) = -\mathbf{n} \times \mathbf{H}$$

and for Faraday's law

$$\mathbf{n} \cdot \Gamma_H(\mathbf{E}) = \mathbf{n} \times \mathbf{E}$$

which means that normal fluxes on external boundaries can only prescribe tangential components for the fields.

#### **BOUNDARY CONDITIONS**

The boundary conditions for outer boundaries are computed from the normal fluxes  $\mathbf{n} \cdot \Gamma_H(\mathbf{E})$  and  $\mathbf{n} \cdot \Gamma_E(\mathbf{H})$ .

- Perfect electric conductor  $\mathbf{n} \times \mathbf{E} = \mathbf{0}$ , or zero tangential components for  $\mathbf{E}$ , is obtained by setting  $\mathbf{n} \cdot \Gamma_H(\mathbf{E}) = \mathbf{0}$ .

- Perfect magnetic conductor  $\mathbf{n} \times \mathbf{H} = \mathbf{0}$ , or zero tangential components for  $\mathbf{H}$ , is obtained by prescribing  $\mathbf{n} \cdot \Gamma_E(\mathbf{H}) = \mathbf{0}$ .
- Electric field  $\mathbf{n} \times \mathbf{E} = \mathbf{n} \times \mathbf{E}_0$ , or  $\mathbf{n} \cdot \Gamma_H(\mathbf{E}) = \mathbf{n} \times \mathbf{E}_0$ .
- Magnetic field  $\mathbf{n} \times \mathbf{H} = \mathbf{n} \times \mathbf{H}_0$ , or  $-\mathbf{n} \cdot \Gamma_E(\mathbf{H}) = \mathbf{n} \times \mathbf{H}_0$ .
- For external boundaries, the surface currents BC means  $\mathbf{n} \times \mathbf{H} = \mathbf{J}_s$ , or  $-\mathbf{n} \cdot \Gamma_E(\mathbf{H}) = \mathbf{J}_s$ .

#### ABSORBING BOUNDARY CONDITION

A simple absorbing boundary can be implemented by setting  $\mathbf{n} \times \mathbf{E} = Z\mathbf{H}$ .

#### *Absorbing Layers*

---

The [Electromagnetic Waves, Time Explicit Interface](#) includes so-called *absorbing layers*, also often referred to as *sponge layers*. The layers work by combining three techniques: a scaling system, filtering, and simple nonreflecting conditions. For a review of the method see, for example, [Ref. 1](#).

The layers are set up by adding the **Absorbing Layer** under the **Definitions** node. This adds a special scaled system. The scaling effectively slows down the propagating waves and ensures that they hit the outer boundary in the normal direction. For the Absorbing Layer domain selection, add an additional [Wave Equations](#) feature, mark the **Activate** check box under the [Filter Parameters](#) section, and enter filter parameters. Filtering attenuates and filters out high-frequency components of the wave. Finally, at the outer boundary of the layer add a simple [Scattering Boundary Condition](#) condition, which will work well to remove all remaining waves as normal incidence has been ensured.



For more detailed information about the filter see the [Filter Parameters](#) section under [Wave Form PDE](#) in the *COMSOL Multiphysics Reference Manual*.

---

For the **Absorbing Layers** select the **Type** (Cartesian, cylindrical, spherical, or user defined) under the **Geometry** section. Enter values for the **Physical Width** and **Pole Distance** under the **Scaling** section.



For more detailed on the **Geometry** and **Scaling** see the [Infinite Elements, Perfectly Matched Layers, and Absorbing Layers](#) in the *COMSOL Multiphysics Reference Manual*.

---

For the layers to work optimally the filter should not be too aggressive. Moreover, the scaled coordinates in the layer domain should also vary smoothly. To inspect the scaled system you can plot the coordinate variables  $x_{\text{absorb\_ab1}}$ ,  $y_{\text{absorb\_ab1}}$ , and  $z_{\text{absorb\_ab1}}$ . Using the absorbing layers with the three combined techniques will enable the reduction of spurious reflections by a factor between 100 and 1000 compared to the incident amplitude.



For an example of a filter parameter combination that can be used for a [Wave Equations](#) feature on an **Absorbing Layer** domain selection see the [Filter Parameters](#) section for the [Wave Equations](#) feature.

---

#### Reference

1. P.G. Petropoulos, L. Zhao, and A.C. Cangellaris, “A Reflectionless Sponge Layer Absorbing Boundary Condition for the Solution of Maxwell’s Equations with High-Order Staggered Finite Difference Schemes,” *J. Comp. Phys.*, vol. 139, pp. 184–208, 1998.





## AC/DC Interfaces



This chapter summarizes the functionality of the electrical circuit interface found under the **AC/DC** branch (  ) when adding a physics interface.

In this chapter:

- [The Electrical Circuit Interface](#)
- [Theory for the Electrical Circuit Interface](#)

See [The Electromagnetics Interfaces](#) in the *COMSOL Multiphysics Reference Manual* for other AC/DC interface and feature node settings.

# The Electrical Circuit Interface

The **Electrical Circuit (cir)** interface () , found under the **AC/DC** branch () when adding a physics interface, is used to model currents and voltages in circuits including voltage and current sources, resistors, capacitors, inductors, and semiconductor devices. Models created with the Electrical Circuit interface can include connections to distributed field models. The physics interface supports stationary, frequency-domain and time-domain modeling and solves Kirchhoff's conservation laws for the voltages, currents and charges associated with the circuit elements.

When this physics interface is added, it adds a default **Ground Node** feature and associates that with node zero in the electrical circuit.



Circuit nodes are nodes in the electrical circuit (electrical nodes) and should not be confused with nodes in the Model Builder tree of the COMSOL Multiphysics software. Circuit node names are not restricted to numerical values but can contain alphanumeric characters.

## SETTINGS

The **Label** is the default physics interface name.

The **Name** is used primarily as a scope prefix for variables defined by the physics interface. Refer to such physics interface variables in expressions using the pattern `<name>.<variable_name>`. In order to distinguish between variables belonging to different physics interfaces, the `name` string must be unique. Only letters, numbers, and underscores (`_`) are permitted in the **Name** field. The first character must be a letter.

The default **Name** (for the first physics interface in the model) is `cir`.

## RESISTANCE IN PARALLEL TO PN JUNCTIONS

For numerical stability, a large resistance is added automatically in parallel to the pn junctions in diodes and BJT devices. Enter a default value for the **Resistance in parallel to pn junctions**  $R_j$ ; (SI unit:  $\Omega$ ). The default value is  $1 \cdot 10^{12} \Omega$ .

## CREATE UNIQUE NODES FOR NEW DEVICES

When this setting is selected (the default), newly added devices will be assigned unused node names. The devices will be disconnected from the rest of the circuit and the nodes should be updated to reflect the actual circuit connections. When this setting is

deselected, new devices will be connected to the lowest-numbered nodes starting from 0.



- [Theory for the Electrical Circuit Interface](#)
- [Connecting to Electrical Circuits](#)

## ELECTRICAL CIRCUIT TOOLBAR

The following nodes are available from the **Electrical Circuit** ribbon toolbar (Windows users), **Electrical Circuit** context menu (Mac or Linux users), or right-click to access the context menu (all users):



For step-by-step instructions and general documentation descriptions, this is the **Electrical Circuit** toolbar.

- [Ground Node](#)
- [Voltmeter](#)
- [Ampère Meter](#)
- [Resistor](#)
- [Capacitor](#)
- [Inductor](#)
- [Voltage Source](#)
- [Current Source](#)
- [Diode](#)
- [Switch](#)
- [Voltage-Controlled Voltage Source<sup>1</sup>](#)
- [Voltage-Controlled Current Source<sup>1</sup>](#)
- [Current-Controlled Voltage Source<sup>1</sup>](#)
- [Current-Controlled Current Source<sup>1</sup>](#)
- [Subcircuit Definition](#)
- [Subcircuit Instance](#)
- [Mutual Inductance](#)
- [Transformer](#)
- [NPN BJT and PNP BJT<sup>2</sup>](#)
- [n-Channel MOSFET and p-Channel MOSFET<sup>2</sup>](#)
- [External I vs. U<sup>3</sup>](#)
- [External U vs. I<sup>3</sup>](#)
- [External I-Terminal<sup>3</sup>](#)
- [SPICE Circuit Import](#)
- [SPICE Circuit Export](#)

<sup>1</sup> Selected from the **Dependent Sources** submenu when you right-click main node.

<sup>2</sup> Selected from the **Transistors** submenu when you right-click main node.

<sup>3</sup> Selected from the **External Couplings** submenu when you right-click main node.

## *Ground Node*

---

The **Ground Node** () feature adds a ground node with the default node number zero to the electrical circuit. This is the default node in the Electrical Circuit interface. More ground nodes can be added but those must have unique node numbers and are by default given higher node numbers.

### **GROUND CONNECTION**

Set the **Node name** for the ground node in the circuit. The convention is to use 0 (zero) for the ground node. If adding more ground nodes, each must have a unique node name (number).

## *Voltmeter*

---

The **Voltmeter** () feature connects a voltmeter (voltage measurement device) between two nodes in the electrical circuit. A voltmeter behaves electrically as an open circuit. The voltmeter node adds a Probe sampling the voltage across it.

### **NODE CONNECTIONS**

Set the two **Node names** for the connecting nodes for the resistor.

## *Ampère Meter*

---

The **Ammeter** () feature connects an ammeter (current measurement device) between two nodes in the electrical circuit. An ammeter behaves electrically as a short circuit. The ammeter node adds a Probe sampling the current through it.

### **NODE CONNECTIONS**

Set the two **Node names** for the connecting nodes for the resistor.

### **DEVICE PARAMETERS**

Enter the **Resistance** of the resistor.

## *Resistor*

---

The **Resistor** () feature connects a resistor between two nodes in the electrical circuit.

### **NODE CONNECTIONS**

Set the two **Node names** for the connecting nodes for the resistor.

### DEVICE PARAMETERS

Enter the **Resistance** of the resistor.

### *Capacitor*

---

The **Capacitor** () feature connects a capacitor between two nodes in the electrical circuit.

### NODE CONNECTIONS

Set the two **Node names** for the connecting nodes for the capacitor.

### DEVICE PARAMETERS

Enter the **Capacitance** of the capacitor.

### *Inductor*

---

The **Inductor** () feature connects an inductor between two nodes in the electrical circuit.

### NODE CONNECTIONS

Set the two **Node names** for the connecting nodes for the inductor.

### DEVICE PARAMETERS

Enter the **Inductance** of the inductor.

### *Voltage Source*

---

The **Voltage Source** () feature connects a voltage source between two nodes in the electrical circuit.

### NODE CONNECTIONS

Set the two **Node names** for the connecting nodes for the voltage source. The first node represents the positive reference terminal.

## DEVICE PARAMETERS

Enter the **Source type** that should be adapted to the selected study type. It can be **General source**, **AC-source**, or a time-dependent **Sine source** or **Pulse source**. Depending on the choice of source, also specify the following parameters:

- For a General source, the **Voltage  $V_{src}$**  (default value: 1 V). General sources are active in Stationary, Time-Dependent and Frequency Domain studies.
- For an AC-source: the **Voltage  $V_{src}$**  (default value: 1 V) and the **Phase  $\Theta$**  (default value: 0 rad). AC-sources are active in Frequency Domain studies only.
- For a sine source: the **Voltage  $V_{src}$**  (default value: 1 V), the **Offset  $V_{off}$**  (default value: 0 V), the **Frequency** (default value: 1 kHz), and the **Phase  $\Theta$**  (default value: 0 rad). The sine sources are active in Time-Dependent studies and also in Stationary studies, providing that a value for  $t$  has been provided as a model parameter or global variable.
- For a pulse source: the **Voltage  $V_{src}$**  (default value: 1 V), the **Offset  $V_{off}$**  (default value: 0 V), the **Delay  $t_d$**  (default value: 0s), the **Rise time  $t_r$**  and **Fall time  $t_f$**  (default values: 0 s), the **Pulse width  $p_w$**  (default value: 1  $\mu$ s), and the **Period  $T_{per}$**  (default value: 2  $\mu$ s). The pulse sources are active in Time-Dependent studies and also in Stationary studies, providing that a value for  $t$  has been provided as a model parameter or global variable.

All values are peak values rather than RMS.



For the AC source, the frequency is a global input set by the solver. AC sources should be used in Frequency-domain studies only. Do not use the **Sine source** unless the model is time dependent.

---

## *Current Source*

The **Current Source** () feature connects a current source between two nodes in the electrical circuit.

## NODE CONNECTIONS

Set the two **Node names** for the connecting nodes for the current source. The first node represents the positive reference terminal from where the current flows through the source to the second node.

## DEVICE PARAMETERS

Enter the **Source type** that should be adapted to the selected study type. It can be **General source**, **AC-source**, or a time-dependent **Sine source** or **Pulse source**. Depending on the choice of source, also specify the following parameters:

- For a General source, the **Current  $i_{src}$**  (default value: 1 A). General sources are active in Stationary, Time-Dependent and Frequency Domain studies.
- For an AC-source: the **Current  $i_{src}$**  (default value: 1 A) and the **Phase  $\Theta$**  (default value: 0 rad). AC-sources are active in Frequency Domain studies only.
- For a sine source: the **Current  $i_{src}$**  (default value: 1 A), the **Offset  $i_{off}$**  (default value: 0 A), the **Frequency** (default value: 1 kHz), and the **Phase  $\Theta$**  (default value: 0 rad). The sine sources are active in Time-Dependent studies and also in Stationary studies, providing that a value for t has been provided as a model parameter or global variable.
- For a pulse source: the **Current  $i_{src}$**  (default value: 1 A), the **Offset  $i_{off}$**  (default value: 0 A), the **Delay  $t_d$**  (default value: 0 s), the **Rise time  $t_r$**  and **Fall time  $t_f$**  (default values: 0 s), the **Pulse width  $p_w$**  (default value: 1  $\mu$ s), and the **Period  $T_{per}$**  (default value: 2  $\mu$ s). The pulse sources are active in Time-Dependent studies and also in Stationary studies, providing that a value for t has been provided as a model parameter or global variable.

All values are peak values rather than RMS.



For the AC source, the frequency is a global input set by the solver. AC sources should be used in frequency-domain studies only. Do not use the **Sine source** unless the model is time dependent.

## *Voltage-Controlled Voltage Source*

The **Voltage-Controlled Voltage Source** () feature connects a voltage-controlled voltage source between two nodes in the electrical circuit. A second pair of nodes define the input control voltage.

## NODE CONNECTIONS

Specify four **Node names**: the first pair for the connection nodes for the voltage source and the second pair defining the input control voltage. The first node in a pair represents the positive reference terminal.

### DEVICE PARAMETERS

There are two options to define the relationship between the control voltage and resulting voltage. The **Use gain** method defines the resulting voltage to be the control voltage multiplied by the gain. The **Custom expression** method can define the relationship with an arbitrary expression.

#### *Voltage-Controlled Current Source*

---

The **Voltage-Controlled Current Source** () feature connects a voltage-controlled current source between two nodes in the electrical circuit. A second pair of nodes define the input control voltage.

### NODE CONNECTIONS

Specify four **Node names**: the first pair for the connection nodes for the current source and the second pair defining the input control voltage. The first node in a pair represents the positive voltage reference terminal or the one from where the current flows through the source to the second node.

### DEVICE PARAMETERS

There are two options to define the relationship between the control voltage and resulting current. The **Use gain** method defines the resulting current to be the control voltage multiplied by the gain (SI units: S). The **Custom expression** method can define the relationship with an arbitrary expression.

#### *Current-Controlled Voltage Source*

---

The **Current-Controlled Voltage Source** () feature connects a current-controlled voltage source between two nodes in the electrical circuit. The input control current is the one flowing through a two-pin device.

### NODE CONNECTIONS

Set two **Node names** for the connection nodes for the voltage source. The first node in a pair represents the positive reference terminal.

### DEVICE PARAMETERS

There are two options to define the relationship between the control current and resulting voltage. The **Use gain** method defines the resulting voltage to be the control current multiplied by the gain (SI units:  $\Omega$ ). The **Custom expression** method can define the relationship with an arbitrary expression.



## *Current-Controlled Current Source*

---

The **Current-Controlled Current Source** () feature connects a current-controlled current source between two nodes in the electrical circuit. The input control current is the one flowing through a named device that must be a two-pin device.

### **NODE CONNECTIONS**

Specify two **Node names** for the connection nodes for the current source. The first node in a pair represents the positive reference terminal from where the current flows through the source to the second node.

### **DEVICE PARAMETERS**

There are two options to define the relationship between the control current and resulting current. The **Use gain** method defines the resulting current to be the control current multiplied by the gain. The **Custom expression** method can define the relationship with an arbitrary expression.

## *Switch*

---

The **Switch** () feature is used to connect or disconnect the conducting path in a circuit under specific conditions.

### **NODE CONNECTIONS**

Specify two **Node names** for the connection nodes for the current source. The first node in a pair represents the positive reference terminal from where the current flows through the source to the second node.

### **SWITCH CONDITIONS**

There are three types of conditions, **Voltage controlled**, **Current controlled**, and **Custom expressions**. For each type of condition there are two conditions, one for turn on and one for turn off. The on condition is true if the **On condition** expression is larger than zero, while the off condition is true if the **Off condition** is less than zero.

The **Initial state** list has three options, **Use on condition**, **Use off condition**, and **Boolean expression**. The two former options mean that the switch will have an initial state matching to the on or off condition. The third option makes the switch's initial state match a custom Boolean expression. Separating on, off, and initial states makes the switch more flexible and can support Schmitt-trigger style switches and various latches.

For the **Voltage controlled** switch, it is necessary to specify two nodes that defines the voltage `sens.v` that the switch state depends on. The conditions must be written as a function of this variable. Similarly, for the **Current controlled** switch it is necessary to specify a two-pin device that defines the current `sens.i` that the switch state depends on.

### SWITCH PARAMETERS

When the switch is in the on state it has a non-zero resistance specified by the **On resistance** expression. For the off state no current flows through the switch (infinite resistance). There is also a transition time for the switch to turn on and off set by the **Switching time** expression. The switch triggers an implicit event that updates a discrete state variable (with suffix `_state`).

### *Subcircuit Definition*

---

The **Subcircuit Definition** () feature is used to define subcircuits, which can be inserted as devices into the main circuit using **Subcircuit Instance** nodes. Create the subcircuit by adding subnodes to the **Subcircuit Definition** node, either by using the **Physics** toolbar, or by right-clicking the **Subcircuit Definition**.

### SUBCIRCUIT PINS

Define the **Pin names** at which the subcircuit connects to the main circuit or to other subcircuits when referenced by a **Subcircuit Instance** node. The **Pin names** refer to circuit nodes in the subcircuit. The order in which the **Pin names** are defined is the order in which they are referenced by a Subcircuit Instance node. The devices constituting the subcircuit should be connected only to the subcircuit's pins and to themselves.

### INPUT PARAMETERS

To display this section, click the **Show More Options** button () and select **Advanced Physics Options**. Specify input parameters to a subcircuit that can be changed from a subcircuit instance. These input parameters can be used in all expression-style edit fields that affect the parameters of a device, for example, resistance, capacitance, and current gain. In this way, a subcircuit can represent a parameterized custom device model.

## Subcircuit Instance

---

The **Subcircuit Instance** () feature represents an instance of a subcircuits defined by a **Subcircuit Definition** feature.

### NODE CONNECTIONS



Select the **Name of subcircuit link** from the list of defined subcircuits in the circuit model and the circuit **Node names** at which the subcircuit instance connects to the main circuit or to another subcircuit if used therein.

### INPUT PARAMETERS

To display this section, click the **Show More Options** button () and select **Advanced Physics Options**. Specify input parameters to a subcircuit that can be changed from a subcircuit instance. These input parameters can be used in all expression-style edit fields that affect the parameters of a device, for example, resistance, capacitance, and current gain. In this way, a subcircuit can represent a parameterized custom device model.

## NPN BJT and PNP BJT

---

The **NPN BJT** () and the **PNP BJT** () device models are large-signal models for bipolar junction transistors (BJT). It is an advanced device model and no thorough description and motivation of the many input parameters are attempted here. Many device manufacturers provide model input parameters for this BJT model. For any particular make of BJT, the device manufacturer should be the primary source of information.

### NODE CONNECTIONS

Specify three **Node names** for the connection nodes for the **BJT** device. These represent the *collector*, *base*, and *emitter* nodes for the **NPN** transistor, and the *emitter*, *base*, and *collector* nodes for the **PNP** transistor.

## MODEL PARAMETERS



Specify the **Model Parameters**. Reasonable defaults are provided but for any particular BJT, the device manufacturer should be the primary source of information.



The interested reader is referred to [Ref. 1](#) for more details on semiconductor modeling within circuits.

For an explanation of the **Model Parameters** see [Bipolar Transistors](#).

## *n-Channel MOSFET and p-Channel MOSFET*

The **n-Channel MOSFET** () and the **p-Channel MOSFET** () device models are large-signal models for, respectively, an n-Channel MOS field-effect transistor (MOSFET) and p-Channel MOSFET. These are advanced device models and no thorough description and motivation of the many input parameters are attempted here. Many device manufacturers provide model parameters for the MOSFET models. For any particular make of MOSFET, the device manufacturer should be the primary source of information.

## NODE CONNECTIONS

Specify four **Node names** for the connection nodes for the **n-Channel MOSFET** or **p-Channel MOSFET** device. These represent the *drain*, *gate*, *source*, and *bulk* nodes, respectively.

## MODEL PARAMETERS

Specify the **Model Parameters**. Reasonable defaults are provided but for any particular MOSFET, the device manufacturer should be the primary source of information.



The interested reader is referred to [Ref. 1](#) for more details on semiconductor modeling within circuits.

For an explanation of the **Model Parameters** see [MOSFET Transistors](#).

## *Mutual Inductance*

The **Mutual Inductance** allows specifying a coupling between two existing [Inductor](#) features in the circuit. The mutual inductance of the coupling is

$$M = k\sqrt{L_1L_2}$$

where  $k$  is the coupling factor and  $L_1$  and  $L_2$  are the inductances of the inductors.

#### DEVICE PARAMETERS

Enter values or expressions for the:

- **Coupling factor**  $k$  (dimensionless). The value must be between 0 and 1, and the default is 0.98.
- **First inductance**  $L_1$  (SI unit: H) and **Second inductance**  $L_2$  (SI unit: H). These must be set to two different [Inductor](#) features in the circuit.

### *Transformer*

---

The **Transformer** feature represents either a combination of two [Inductor](#) and a [Mutual Inductance](#) features, or an ideal transformer.

#### NODE CONNECTIONS

Enter or edit the table in the **Node names** column for the **primary** and **secondary** node connections.

#### DEVICE PARAMETERS

Choose a **Transformer model** — **Specify inductors** (the default) or **Ideal transformer**.

For **Specify inductors** enter values or expressions for the:

- **Coupling factor**  $k$  (dimensionless). The default is 0.98.
- **First inductance**  $L_1$  (SI unit: H). The default is 1 mH.
- **Second inductance**  $L_2$  (SI unit: H). The default is 1 mH.

For **Ideal transformer** enter values or expressions for the **Winding ratio**  $N_1/N_2$  (dimensionless). The default is 10.

### *Diode*

---

The **Diode** device model () is a large-signal model for a diode. It is an advanced device model and no thorough description and motivation of the many input parameters are attempted here. The interested reader is referred to [Ref. 1](#) for more details on semiconductor modeling within circuits. Many device manufacturers

provide model parameters for this diode model. For any particular make of diode, the device manufacturer should be the primary source of information.

#### NODE CONNECTIONS

Specify two **Node names** for the positive and negative nodes for the **Diode** device.

#### MODEL PARAMETERS

Specify the **Model Parameters**. Reasonable defaults are provided but for any particular diode, the device manufacturer should be the primary source of information.



For an explanation of the **Model Parameters** see [Diode](#).

---

### *External I vs. U*

The **External I vs. U** () feature connects an arbitrary voltage measurement (for example, a circuit terminal or circuit port boundary or a coil domain from another physics interface) as a voltage source between two nodes in the electrical circuit. The resulting circuit current from the first node to the second node is typically coupled back as a prescribed current source in the context of the voltage measurement.

#### NODE CONNECTIONS

Specify the two **Node names** for the connecting nodes for the voltage source. The first node represents the positive reference terminal.

#### EXTERNAL DEVICE

Enter the source of the **Voltage**. If circuit or current excited terminals or circuit ports are defined on boundaries or domains or a multiturn coil domains is defined in other physics interfaces, these display as options in the **Voltage** list. Also select the **User defined** option and enter your own voltage variable, for example, using a suitable coupling operator. For inductive or electromagnetic wave propagation models, the voltage measurement must be performed as an integral of the electric field because the electric

potential only does not capture induced EMF. Also the integration must be performed over a distance that is short compared to the local wavelength.



Except when coupling to a circuit terminal, circuit port, or coil, the current flow variable must be manually coupled back in the electrical circuit to the context of the voltage measurement. This applies also when coupling to a current excited terminal. The name of this current variable follows the convention `cirn.IvsUm_i`, where `cirn` is the tag of the Electrical Circuit interface node and `IvsUm` is the tag of the **External I vs. U** node. The tags are typically displayed within curly brackets `{ }` in the Model Builder.



[Nonlocal Couplings and Coupling Operators](#) in the *COMSOL Multiphysics Reference Manual*

### *External U vs. I*

The **External U vs. I** () feature connects an arbitrary current measurement (for example, a coil domain from another physics interface) as a current source between two nodes in the electrical circuit. The resulting circuit voltage between the first node and the second node is typically coupled back as a prescribed voltage source in the context of the current measurement.

#### **NODE CONNECTIONS**

Specify the two **Node names** for the connecting nodes for the current source. The current flows from the first node to the second node.

#### **EXTERNAL DEVICE**

Enter the source of the **Current**. Voltage excited terminals or lumped ports defined on boundaries in other physics interfaces are natural candidates but do not appear as options in the **Voltage** list because those do not have an accurate built-in current

measurement variable. A **User defined** option must be selected and a current variable entered, for example, using a suitable coupling operator.



The voltage variable must be manually coupled back in the electrical circuit to the context of the current measurement. This applies also when coupling to a voltage excited terminal or lumped port. The name of this voltage variable follows the convention `cirn.UvsIm_v`, where `cirn` is the tag of the Electrical Circuit interface node and `UvsIm` is the tag of the **External U vs. I** node. The tags are typically displayed within curly brackets `{}` in the Model Builder.



[Nonlocal Couplings and Coupling Operators](#) in the *COMSOL Multiphysics Reference Manual*

### *External I-Terminal*

The **External I-Terminal** () feature connects an arbitrary voltage-to-ground measurement (for example, a circuit terminal from another physics interface) as a voltage-to-ground assignment to a node in the electrical circuit. The resulting circuit current from the node is typically coupled back as a prescribed current source in the context of the voltage measurement. This node does not apply when coupling to inductive or electromagnetic wave propagation models because then voltage must be defined as a line integral between two points rather than a single point measurement of electric potential. For such couplings, use the [External I vs. U](#) node instead.

#### **NODE CONNECTIONS**

Set the **Node name** for the connecting node for the voltage assignment.

#### **EXTERNAL TERMINAL**

Enter the source of the **Voltage**. If circuit- or current-excited terminals are defined on boundaries in other physics interfaces, these display as options in the **Voltage** list. Also



select the **User defined** option and enter a voltage variable, for example, using a suitable coupling operator.



- Except when coupling to a circuit terminal, the current flow variable must be manually coupled back in the electrical circuit to the context of the voltage measurement. This applies also when coupling to a current excited terminal. The name of this current variable follows the convention `cirn.termIm_i`, where `cirn` is the tag of the Electrical Circuit interface node and `termIm` is the tag of the **External I-Terminal** node. The tags are typically displayed within curly brackets `{}` in the Model Builder.
- When connecting the finite element model between two circuit nodes that both are not grounded, the **External I-Terminal** node cannot be used. In this case, use [External I vs. U](#) or [External U vs. I](#) instead.



[Nonlocal Couplings and Coupling Operators](#) in the *COMSOL Multiphysics Reference Manual*.



### *SPICE Circuit Import*

Right-click the **Electrical Circuit** () feature node to import an existing SPICE netlist (select **Import Spice Netlist**). A window opens — enter a file location or browse your directories to find one. The default file extension for a SPICE netlist is `.cir`. The SPICE circuit import translates the imported netlist into Electrical Circuit interface nodes so these define the subset of SPICE features that can be imported.



See [SPICE Import and Export](#) about the supported SPICE commands.

### *SPICE Circuit Export*

Right-click the **Electrical Circuit** () feature node to export the current circuit to the SPICE netlist file format (select **Export Spice Netlist** ). A window opens — enter a

file location or browse your directories to find one. The default file extension for a SPICE netlist is `.cir`. The compatible circuit nodes are exported as SPICE devices



See [SPICE Export](#) for more details on the supported SPICE commands.

---

# Theory for the Electrical Circuit Interface

The [Electrical Circuit Interface](#) theory is discussed in this section:

- [Electric Circuit Modeling and the Semiconductor Device Models](#)
- [Bipolar Transistors](#)
- [MOSFET Transistors](#)
- [Diode](#)
- [Reference for the Electrical Circuit Interface](#)



[Connecting to Electrical Circuits](#)

---

## *Electric Circuit Modeling and the Semiconductor Device Models*

---

Electrical circuit modeling capabilities are useful when simulating all sorts of electrical and electromechanical devices ranging from heaters and motors to advanced plasma reactors in the semiconductor industry. There are two fundamental ways that an electrical circuit model relates to a physical field model.

- The field model is used to get a better, more accurate description of a single device in the electrical circuit model.
- The electrical circuit is used to drive or terminate the device in the field model in such a way that it makes more sense to simulate both as a tightly coupled system.

The Electrical Circuit interface makes it possible to add nodes representing circuit elements directly to the Model Builder tree in a COMSOL Multiphysics model. The circuit variables can then be connected to a physical device model to perform co-simulations of circuits and multiphysics. The model acts as a device connected to the circuit so that its behavior is analyzed in larger systems.

The fundamental equations solved by the Electrical Circuit interface are Kirchhoff's circuit laws, which in turn can be deduced from Maxwell's equations. The supported study types are Stationary, Frequency Domain, and Time Dependent.

There are three more advanced large-signal semiconductor device features available in the Electrical Circuit interface. The equivalent circuits and the equations defining their non-ideal circuit elements are described in this section. For a more complete treatise on semiconductor device modeling see [Ref. 1](#).

### Bipolar Transistors

Figure 5-1 illustrates the equivalent circuit for the npn bipolar junction transistor.

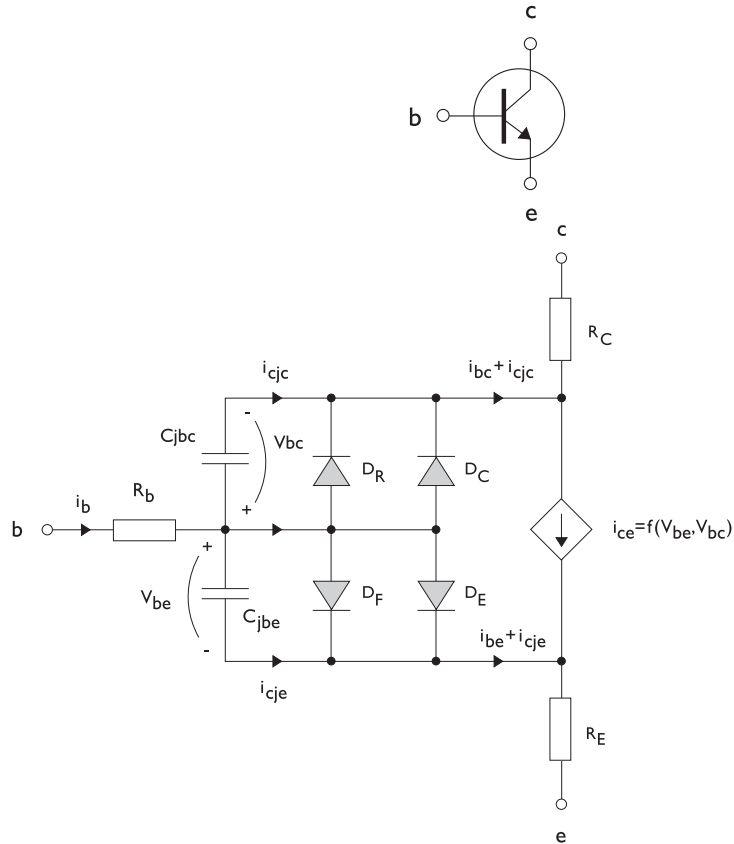

Figure 5-1: A circuit for the bipolar transistor.

The pnp transistor model is similar in all regards to the npn transistor, with the difference that the polarities of the currents and voltages involved are reversed. The following equations are used to compute the relations between currents and voltages in the circuit.

$$v_{rb} = \frac{1}{A} \left( R_{BM} - \frac{R_B - R_{BM}}{f_{bq}} \right) i_b$$

$$f_{bq} = \frac{1}{2 \left( 1 - \frac{v_{bc}}{V_{AF}} - \frac{v_{be}}{V_{AR}} \right)} \left( 1 + \sqrt{1 + 4I_S \left( \frac{e^{\frac{v_{be}}{N_F V_T}} - 1}{I_{KF} A} + \frac{e^{\frac{v_{bc}}{N_R V_T}} - 1}{I_{KR} A} \right)} \right)$$

$$i_{be} = A \left( \frac{I_S}{B_F} \left( e^{\frac{v_{be}}{N_F V_T}} - 1 \right) + I_{SE} \left( e^{\frac{v_{be}}{N_E V_T}} - 1 \right) \right)$$

$$i_{bc} = A \left( \frac{I_S}{B_R} \left( e^{\frac{v_{bc}}{N_R V_T}} - 1 \right) + I_{SC} \left( e^{\frac{v_{bc}}{N_C V_T}} - 1 \right) \right)$$

$$i_{ce} = A \left( \frac{I_S}{f_{bq}} \left( e^{\frac{v_{be}}{N_F V_T}} + e^{\frac{v_{bc}}{N_C V_T}} \right) \right)$$

$$V_T = \frac{k_B T_{NOM}}{q}$$

There are also two capacitances that use the same formula as the junction capacitance of the diode model. In the parameter names below, replace  $x$  with  $C$  for the base-collector capacitance and  $E$  for the base-emitter capacitance.

$$C_{jbx} = AC_{Jx} \times \begin{cases} \left( 1 - \frac{v_{bx}}{V_{Jx}} \right)^{-M_{Jx}} & v_{bx} < F_C V_{Jx} \\ (1 - F_C)^{-1 - M_{Jx}} \left( 1 - F_C (1 + M_{Jx}) + M_{Jx} \frac{v_{bx}}{V_{Jx}} \right) & v_{bx} \geq F_C V_{Jx} \end{cases}$$

The model parameters are listed in the table below.

TABLE 5-1: BIPOLAR TRANSISTOR MODEL PARAMETERS.

PARAMETER	DEFAULT	DESCRIPTION
$B_F$	100	Ideal forward current gain
$B_R$	1	Ideal reverse current gain
$C_{JC}$	0 F/m <sup>2</sup>	Base-collector zero-bias depletion capacitance
$C_{JE}$	0 F/m <sup>2</sup>	Base-emitter zero-bias depletion capacitance
$F_C$	0.5	Breakdown current
$I_{KF}$	Inf (A/m <sup>2</sup> )	Corner for forward high-current roll-off

TABLE 5-1: BIPOLAR TRANSISTOR MODEL PARAMETERS.

PARAMETER	DEFAULT	DESCRIPTION
$I_{KR}$	Inf ( $A/m^2$ )	Corner for reverse high-current roll-off
$I_S$	$10^{-15} A/m^2$	Saturation current
$I_{SC}$	$0 A/m^2$	Base-collector leakage saturation current
$I_{SE}$	$0 A/m^2$	Base-emitter leakage saturation current
$M_{JC}$	1/3	Base-collector grading coefficient
$M_{JE}$	1/3	Base-emitter grading coefficient
$N_C$	2	Base-collector ideality factor
$N_E$	1.4	Base-emitter ideality factor
$N_F$	1	Forward ideality factor
$N_R$	1	Reverse ideality factor
$R_B$	$0 \Omega \cdot m^2$	Base resistance
$R_{BM}$	$0 \Omega \cdot m^2$	Minimum base resistance
$R_C$	$0 \Omega \cdot m^2$	Collector resistance
$R_E$	$0 \Omega \cdot m^2$	Emitter resistance
$T_{NOM}$	298.15 K	Device temperature
$V_{AF}$	Inf (V)	Forward Early voltage
$V_{AR}$	Inf (V)	Reverse Early voltage
$V_{JC}$	0.71 V	Base-collector built-in potential
$V_{JE}$	0.71 V	Base-emitter built-in potential

## MOSFET Transistors

Figure 5-2 illustrates an equivalent circuit for the n-channel MOSFET transistor. The p-channel MOSFET transistor is treated similarly, but the polarities of the involved voltages are reversed.

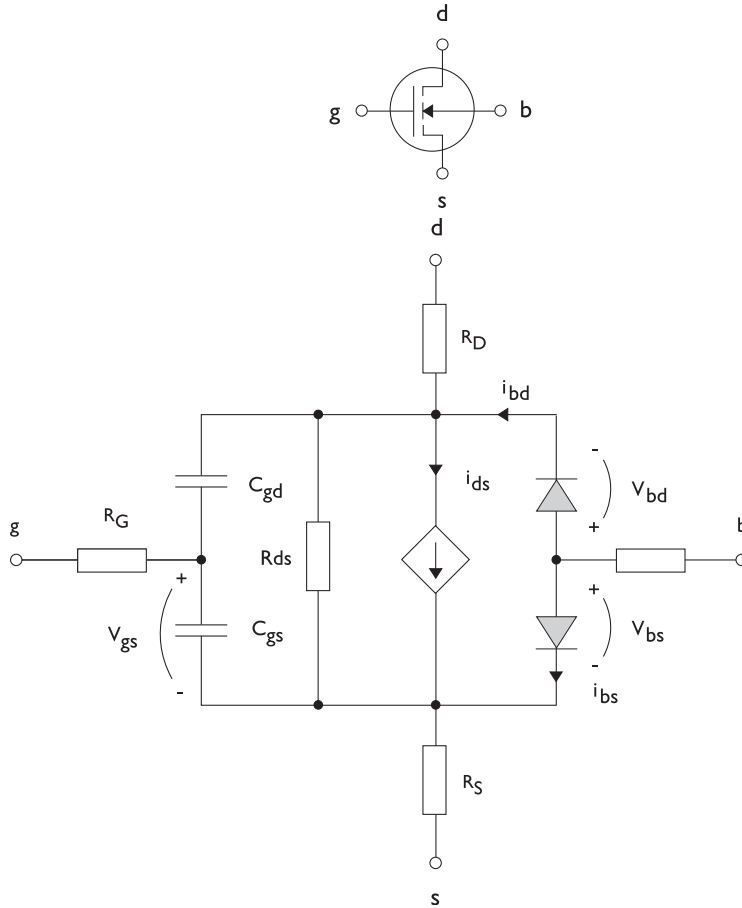

Figure 5-2: A circuit for the MOSFET transistor.

The following equations are used to compute the relations between currents and voltages in the circuit.

$$i_{ds} = \begin{cases} \frac{WK_P}{L} \frac{1}{2} (1 + \Lambda v_{ds}) v_{ds} (2v_{th} - v_{ds}) & v_{ds} < v_{th} \\ \frac{WK_P}{L} \frac{1}{2} (1 + \Lambda v_{ds}) v_{th}^2 & v_{ds} \geq v_{th} \\ 0 & v_{ds} < v_{th} \leq 0 \end{cases}$$

$$v_{th} = v_{gs} - (V_{TO} + \Gamma(\sqrt{\Phi} - v_{bs} - \sqrt{\Phi}))$$

$$i_{bd} = I_S \left( e^{\frac{v_{bd}}{NV_T}} - 1 \right)$$

$$i_{bs} = I_S \left( e^{\frac{v_{bs}}{NV_T}} - 1 \right)$$

$$V_T = \frac{k_B T_{NOM}}{q}$$

There are also several capacitances between the terminals

$$C_{gd} = C_{gd0} W$$

$$C_{gs} = C_{gs0} W$$

$$C_{jbd} = C_{BD} \times \begin{cases} \left(1 - \frac{v_{bd}}{P_B}\right)^{-M_J} & v_{bx} < F_C P_B \\ (1 - F_C)^{-1 - M_J} \left(1 - F_C(1 + M_J) + M_J \frac{v_{bx}}{P_B}\right) & v_{bx} \geq F_C P_B \end{cases}$$

The model parameters are as follows:

TABLE 5-2: MOSFET TRANSISTOR MODEL PARAMETERS.

PARAMETER	DEFAULT	DESCRIPTION
$C_{BD}$	0 F/m	Bulk-drain zero-bias capacitance
$C_{GDO}$	0 F/m	Gate-drain overlap capacitance
$C_{GSO}$	0 F/m	Gate-source overlap capacitance
$F_C$	0.5	Capacitance factor
$I_S$	1e-13 A	Bulk junction saturation current
$K_P$	2e-5 A/V <sup>2</sup>	Transconductance parameter
$L$	50e-6 m	Gate length
$M_J$	0.5	Bulk junction grading coefficient



TABLE 5-2: MOSFET TRANSISTOR MODEL PARAMETERS.

PARAMETER	DEFAULT	DESCRIPTION
$N$	1	Bulk junction ideality factor
$P_B$	0.75 V	Bulk junction potential
$R_B$	0 $\Omega$	Bulk resistance
$R_D$	0 $\Omega$	Drain resistance
$R_{DS}$	Inf ( $\Omega$ )	Drain-source resistance
$R_G$	0 $\Omega$	Gate resistance
$R_S$	0 $\Omega$	Source resistance
$T_{NOM}$	298.15 K	Device temperature
$V_{TO}$	0 V	Zero-bias threshold voltage
$W$	50e-6 m	Gate width
$\Gamma$ (GAMMA)	1 $\text{V}^{0.5}$	Bulk threshold parameter
$\Phi$ (PHI)	0.5 V	Surface potential
$\Lambda$ (LAMBDA)	0 1/V	Channel-length modulation

## Diode

Figure 5-3 illustrates equivalent circuit for the diode.

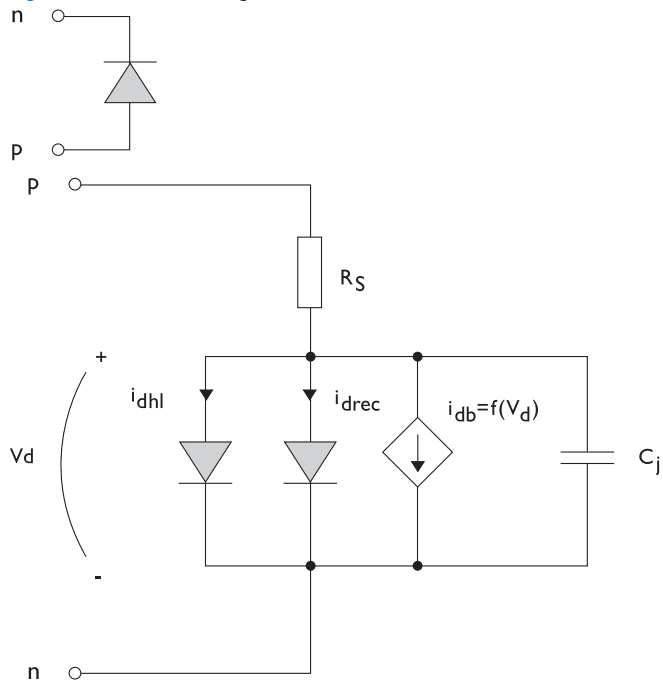

Figure 5-3: A circuit for the diode.

The following equations are used to compute the relations between currents and voltages in the circuit.

$$i_d = i_{dhl} + i_{drec} + i_{db} + i_c$$

$$i_{dhl} = I_S \left( e^{\frac{v_d}{NV_T}} - 1 \right) \frac{1}{\sqrt{1 + \frac{I_S}{I_{KF}} \left( e^{\frac{v_d}{NV_T}} - 1 \right)}}$$

$$i_{drec} = I_{SR} \left( e^{\frac{v_d}{N_R V_T}} - 1 \right)$$

$$i_{db} = I_{BV} e^{\frac{v_d + B_V}{N_{BV} V_T}}$$

$$C_j = C_{J0} \times \begin{cases} \left( 1 - \frac{v_d}{V_J} \right)^{-M} & v_d < F_C V_J \\ (1 - F_C)^{-1-M} \left( 1 - F_C (1 + M) + M \frac{v_d}{V_J} \right) & v_d \geq F_C V_J \end{cases}$$

$$V_T = \frac{k_B T_{NOM}}{q}$$

where the following model parameters are required.

TABLE 5-3: DIODE TRANSISTOR MODEL PARAMETERS.

PARAMETER	DEFAULT	DESCRIPTION
$B_V$	Inf (V)	Reverse breakdown voltage
$C_{J0}$	0 F	Zero-bias junction capacitance
$F_C$	0.5	Forward-bias capacitance coefficient
$I_{BV}$	1 e-09 A	Current at breakdown voltage
$I_{KF}$	Inf (A)	Corner for high-current roll-off
$I_S$	1 e-13 A	Saturation current
$M$	0.5	Grading coefficient
$N$	1	Ideality factor
$N_{BV}$	1	Breakdown ideality factor
$N_R$	2	Recombination ideality factor
$R_S$	0 $\Omega$	Series resistance
$T_{NOM}$	298.15 K	Device temperature
$V_J$	1.0 V	Junction potential

*Reference for the Electrical Circuit Interface*

---

I. P. Antognetti and G. Massobrio, *Semiconductor Device Modeling with Spice*, 2nd ed., McGraw-Hill, 1993.

## Heat Transfer Interfaces

This chapter describes [The Microwave Heating Interface](#) found under the **Heat Transfer>Electromagnetic Heating** branch () when adding a physics interface.

See [The Heat Transfer Interfaces](#) and [The Joule Heating Interface](#) in the *COMSOL Multiphysics Reference Manual* for other Heat Transfer interface and feature node settings.

# The Microwave Heating Interface

The **Microwave Heating** interface () is used to model electromagnetic heating for systems and devices that are on a scale ranging from 1/10 of a wavelength up to, depending on available computer memory, about 10 wavelengths. This multiphysics interface adds an Electromagnetic Waves, Frequency Domain interface and a Heat Transfer in Solids interface. The multiphysics couplings add the electromagnetic losses from the electromagnetic waves as a heat source, and the electromagnetic material properties can depend on the temperature. The modeling approach is based on the assumption that the electromagnetic cycle time is short compared to the thermal time scale.

The following table shows what study step combinations of Electromagnetic Waves, Frequency Domain interface and Heat Transfer in Solids interface are supported from the Microwave Heating interface.

TABLE 6-1: STUDY STEP COMBINATIONS OF ELECTROMAGNETIC WAVES, FREQUENCY DOMAIN INTERFACE AND HEAT TRANSFER IN SOLIDS INTERFACE

PRESET STUDIES	ELECTROMAGNETIC WAVES, FREQUENCY DOMAIN INTERFACE	HEAT TRANSFER IN SOLIDS INTERFACE
Frequency-Stationary	Frequency Domain	Stationary
Frequency-Transient	Frequency Domain	Transient
Frequency-Stationary, One-Way Electromagnetic Heating	Frequency Domain	Stationary
Frequency-Transient, One-Way Electromagnetic Heating	Frequency Domain	Transient

When a predefined **Microwave Heating** interface is added from the **Heat Transfer>Electromagnetic Heating** branch () of the **Model Wizard** or **Add Physics** windows, **Electromagnetic Waves, Frequency Domain** and **Heat Transfer in Solids** interfaces are added to the Model Builder.

In addition, a **Multiphysics** node is added, which automatically includes the multiphysics coupling feature **Electromagnetic Heating**.

## *On the Constituent Physics Interfaces*

The Electromagnetic Waves, Frequency Domain interface computes time-harmonic electromagnetic field distributions. To use this physics interface, the maximum mesh element size should be limited to a fraction of the wavelength. Thus, the domain size that can be simulated scales with the amount of available computer memory and the

wavelength. The physics interface solves the time-harmonic wave equation for the electric field.

The Heat Transfer in Solids interface provides features for modeling heat transfer by conduction, convection, and radiation. A Heat Transfer in Solids model is active by default on all domains. All functionality for including other domain types, such as a fluid domain, is also available. The temperature equation defined in solid domains corresponds to the differential form of Fourier's law that may contain additional contributions like heat sources.



In previous versions of COMSOL Multiphysics, a specific physics interface called Microwave Heating was added to the Model Builder. Now, a predefined multiphysics coupling approach is used, improving the flexibility and design options for your modeling. For specific details, see [Multiphysics Modeling Workflow](#) in the *COMSOL Multiphysics Reference Manual*.

#### SETTINGS FOR PHYSICS INTERFACES AND COUPLING FEATURE

When physics interfaces are added using the predefined couplings, for example **Microwave Heating**, specific settings are included with the physics interfaces and the coupling feature.

However, if physics interfaces are added one at a time, followed by the coupling features, these modified settings are not automatically included.

For example, if single **Electromagnetic Waves, Frequency Domain** and **Heat Transfer in Solids** interfaces are added, the COMSOL adds an empty **Multiphysics** node. You can choose **Electromagnetic Heating** from the available coupling features, but the modified settings are not included.



Coupling features are available from the context menu (right-click the **Multiphysics** node) or from the **Physics** toolbar, **Multiphysics** menu.

TABLE 6-2: MODIFIED SETTINGS FOR A MICROWAVE HEATING INTERFACE

PHYSICS INTERFACE OR COUPLING FEATURE	MODIFIED SETTINGS (IF ANY)
Electromagnetic Waves, Frequency Domain	No changes.

TABLE 6-2: MODIFIED SETTINGS FOR A MICROWAVE HEATING INTERFACE

PHYSICS INTERFACE OR COUPLING FEATURE	MODIFIED SETTINGS (IF ANY)
Heat Transfer in Solids	No changes.
Electromagnetic Heating	<p>The <b>Domain Selection</b> is the same as that of the participating physics interfaces.</p> <p>The <b>Boundary Selection</b> is the same as the exterior and interior boundaries of the <b>Domain Selection</b> of the participating physics interfaces.</p> <p>The corresponding <b>Electromagnetic Waves, Frequency Domain</b> and <b>Heat Transfer in Solids</b> interfaces are preselected in the <a href="#">Coupled Interfaces</a> section (described in the <i>COMSOL Multiphysics Reference Manual</i>).</p>



A side effect of adding physics interfaces one at a time is that four study types — Frequency-Stationary; Frequency-Transient; Frequency-Stationary, One-Way Electromagnetic Heating; and Frequency-Transient, One-Way Electromagnetic Heating — are not available for selection until *after* at least one coupling feature is added. In this case, it is better to initially not add any study at all, then add the coupling features to the **Multiphysics** node, and lastly, open the **Add Study** window and add a study sequence below the **Preset Studies for Selected Multiphysics** heading.

## PHYSICS INTERFACES AND COUPLING FEATURE



Use the online help in COMSOL Multiphysics to locate and search all the documentation. All these links also work directly in COMSOL Multiphysics when using the Help system.

### *Coupling Feature*

The [Electromagnetic Heating](#) coupling feature node is described in this section.



### Physics Interface Features

Physics nodes are available from the **Physics** ribbon toolbar (Windows users), **Physics** context menu (Mac or Linux users), or right-click to access the context menu (all users).



In general, to add a node, go to the **Physics** toolbar, no matter what operating system you are using. Subnodes are available by clicking the parent node and selecting it from the **Attributes** menu.

- The available physics features for [The Electromagnetic Waves, Frequency Domain Interface](#) are listed in the section [Domain, Boundary, Edge, Point, and Pair Nodes for the Electromagnetic Waves, Frequency Domain Interface](#).
- See [The Heat Transfer Interfaces](#) in the *COMSOL Multiphysics Reference Manual* for information about the available physics features for heat transfer.



If you have an add-on module, such as the Heat Transfer Module, there are additional specialized physics nodes available and described in the individual module documentation.



*Microwave Oven*: Application Library path **RF\_Module/  
Microwave\_Heating/microwave\_oven**

### Electromagnetic Heating

The **Electromagnetic Heating** node represents the electromagnetic losses,  $Q_e$  (SI unit:  $W/m^3$ ), as a heat source in the heat transfer part of the model. It is given by

$$Q_e = Q_{rh} + Q_{ml}$$

where the resistive losses are

$$Q_{rh} = \frac{1}{2} \text{Re}(\mathbf{J} \cdot \mathbf{E}^*)$$

and the magnetic losses are

$$Q_{ml} = \frac{1}{2} \text{Re}(i\omega \mathbf{B} \cdot \mathbf{H}^*)$$

In addition, it maps the electromagnetic surface losses as a heat source on the boundary (SI unit:  $\text{W}/\text{m}^2$ ) in the heat transfer part of the model.

### SETTINGS

The **Label** is the default multiphysics coupling feature name.

The **Name** is used primarily as a scope prefix for variables defined by the coupling node. Refer to such variables in expressions using the pattern `<name>.<variable_name>`. In order to distinguish between variables belonging to different coupling nodes or physics interfaces, the name string must be unique. Only letters, numbers and underscores (`_`) are permitted in the **Name** field. The first character must be a letter.

The default **Name** (for the first multiphysics coupling feature in the model) is `emh`.

### DOMAIN SELECTION

When nodes are added from the context menu, you can select **Manual** (the default) from the **Selection** list to choose specific domains to define the electromagnetic heat source or select **All domains** as needed.

When **Electromagnetic Heating** is added as an effect of adding a **Microwave Heating** interface, the selection is the same as for the participating interfaces.

Only domains that are active in the physics interfaces selected in the **Coupled Interfaces** section can be selected.

### BOUNDARY SELECTION

When nodes are added from the context menu, you can select **Manual** (the default) from the **Selection** list to choose specific boundaries to define the electromagnetic boundary heat source or select **All boundaries** as needed.

When **Electromagnetic Heating** is added as an effect of adding a **Microwave Heating** interface, the selection is the same as the exterior and interior boundaries of the **Domain Selection** of the participating physics interfaces.

Only boundaries that are active in the physics interfaces selected in the **Coupled Interfaces** section can be selected.

### COUPLED INTERFACES

This section defines the physics involved in the **Electromagnetic Heating** multiphysics coupling. By default, the applicable physics interface is selected in the **Electromagnetic** list to apply the **Heat transfer** to its physics interface to establish the coupling.

You can also select **None** from either list to uncouple the **Electromagnetic Heating** node from a physics interface. If the physics interface is removed from the **Model Builder**, for example **Heat Transfer in Solids** is deleted, then the **Heat transfer** list defaults to **None** as there is nothing to couple to.



If a physics interface is deleted and then added to the model again, and in order to re-establish the coupling, you need to choose the physics interface again from the **Heat transfer** or **Electromagnetic** lists. This is applicable to all multiphysics coupling nodes that would normally default to the once present physics interface. See [Multiphysics Modeling Workflow](#) in the *COMSOL Multiphysics Reference Manual*.

---



## Glossary

This [Glossary of Terms](#) contains finite element modeling terms in an electromagnetic waves context. For mathematical terms as well as geometry and CAD terms specific to the COMSOL Multiphysics<sup>®</sup> software and documentation, see the glossary in the *COMSOL Multiphysics Reference Manual*. For references to more information about a term, see the index.

# Glossary of Terms

**absorbing boundary** A boundary that lets an electromagnetic wave propagate through the boundary without reflections.

**anisotropy** Variation of material properties with direction.

**constitutive relation** The relation between the **D** and **E** fields and between the **B** and **H** fields. These relations depend on the material properties.

**cutoff frequency** The lowest frequency for which a given mode can propagate through, for example, a waveguide or optical fiber.

**edge element** See *vector element*.

**eigenmode** A possible propagating mode of, for example, a waveguide or optical fiber.

**electric dipole** Two equal and opposite charges  $+q$  and  $-q$  separated a short distance  $d$ . The electric dipole moment is given by  $\mathbf{p} = q\mathbf{d}$ , where  $\mathbf{d}$  is a vector going from  $-q$  to  $+q$ .

**gauge transformation** A variable transformation of the electric and magnetic potentials that leaves Maxwell's equations invariant.

**lumped port** A type of port feature. Use the lumped port to excite the model with a voltage, current, or circuit input. The lumped port must be applied between two metallic objects, separated by much less than a wavelength.

**magnetic dipole** A small circular loop carrying a current. The magnetic dipole moment is  $\mathbf{m} = IA\mathbf{e}$ , where  $I$  is the current carried by the loop,  $A$  its area, and  $\mathbf{e}$  a unit vector along the central axis of the loop.

**Maxwell's equations** A set of equations, written in differential or integral form, stating the relationships between the fundamental electromagnetic quantities.

**Nedelec's edge element** See *vector element*.

**perfect electric conductor (PEC)** A material with high electrical conductivity, modeled as a boundary where the electric field is zero.

**perfect magnetic conductor** A material with high permeability, modeled as a boundary where the magnetic field is zero.

**phasor** A complex function of space representing a sinusoidally varying quantity.

**quasistatic approximation** The electromagnetic fields are assumed to vary slowly, so that the retardation effects can be neglected. This approximation is valid when the geometry under study is considerably smaller than the wavelength.

**surface current density** Current density defined on the surface. The component normal to the surface is zero. The unit is A/m.

**vector element** A finite element often used for electromagnetic vector fields. The tangential component of the vector field at the mesh edges is used as a degree of freedom. Also called *Nedelec's edge element* or just *edge element*.





# I n d e x

- 2D
  - wave equations 105
- 2D axisymmetry
  - wave equations 105
- 2D axisymmetry, covariant formulation
  - 220
- 2D modeling techniques 28, 30
- 3D modeling techniques 30
- A**
  - absorbing boundary (node) 180
  - AC/DC Module 13
  - ammeter (node) 252
  - anisotropic materials 79
  - antiperiodicity, periodic boundaries and
    - 34
  - application libraries examples
    - polarization plot 54
    - S-parameter calculations 47
  - Application Libraries window 21
  - application library examples
    - analyze as a tem field 119
    - axial symmetry 29
    - background field 194
    - Cartesian coordinates 29
    - connecting electrical circuits to physics interfaces 61
    - diffraction order 129
    - Drude-Lorentz polarization 176
    - electrical circuits 61
    - electromagnetic waves, frequency domain interface 101, 212
    - electromagnetic waves, transient 170
    - far field plots 42
    - far-field calculation 113
    - far-field calculations 38
    - far-field domain and far-field calculation 111

- hexagonal periodic port 123
- impedance boundary condition 148
- Linearly polarized plane wave background field (2D axisymmetry) 97
- lossy eigenvalue calculations 56
- lumped element 139, 154, 160, 163
- lumped port 52, 137
- microwave heating 281
- perfect electric conductor 114
- perfect magnetic conductor 115
- periodic boundary condition 159
- periodic boundary conditions 34
- periodic port reference point 132
- port 126
- port sweeps 48
- reduced order modeling 69–70
- scattered fields 37
- scattering boundary condition 143
- symmetry plane 164
- transmission line 178
- applying electromagnetic sources 31
- Archie's law (node) 167
- attenuation constant 237
- axisymmetric models 29
- axisymmetric waves theory
  - frequency domain 222
  - time domain 225
- B**
  - background field (node) 193
  - backward-propagating wave 237
  - base node 259
  - bipolar junction transistor 259
  - Bloch-Floquet periodicity 158
  - boundary conditions
    - electromagnetics theory 76
    - nonlinear eigenfrequency problems and 57

- perfect electric conductor 114
- perfect magnetic conductor 115
- periodic 34
- using efficiently 31
- boundary mode analysis 58
- boundary nodes
  - electromagnetic waves, boundary elements interface 209
  - electromagnetic waves, frequency domain interface 101
  - electromagnetic waves, time explicit 185
  - electromagnetic waves, transient 171
  - transmission line 178
- bulk node 260

**C**

- calculating
  - S-parameters 47
- capacitor (node) 253
- Cartesian coordinates 28
- cementation exponent 167, 235
- circuit import, SPICE 265
- circular port reference axis (node) 127
- collector node 259
- common settings 16
- complex permittivity, electric losses and 222
- complex propagation constant 237
- complex relative permeability, magnetic losses and 224
- constitutive relations 241
- constitutive relations theory 75–76
- continuity, periodic boundaries and 34
- coupling, to the electrical circuits interface 62
- Covariant formulation, 2D axisymmetry 220
- curl-curl formulation 241
- current source (node) 254

- current-controlled current source (node) 257
- current-controlled voltage source (node) 256
- cutoff frequency 83
- cylindrical coordinates 29
- cylindrical waves 141

**D**

- Debye dispersion model 108
- device models, electrical circuits 268
- dielectrics and perfect conductors 77
- diffraction order (node) 128
- diode (node) 261
- diode transistor model 274
- dispersive materials 80
- divergence constraint (node) 110
- documentation 19
- domain nodes
  - electromagnetic waves, boundary elements interface 209
  - electromagnetic waves, frequency domain interface 101
  - electromagnetic waves, time explicit 185
- drain node 260
- Drude-Lorentz dispersion model 108
- Drude-Lorentz polarization (node) 176

**E**

- E (PMC) symmetry 38
- edge current (node) 165
- effective medium (node) 167
- eigenfrequency analysis 56
- eigenfrequency calculations theory 226
- eigenfrequency study 219
- eigenmode analysis 82
- eigenvalue (node) 58
- electric current density (node) 189
- electric field (node) 139, 190
- electric field coupling (node) 211
- electric losses theory 222

- electric point dipole (node) 165
  - electric potential (node) 127
  - electric susceptibility 242
  - electrical circuit interface 250
    - theory 267
  - electrical circuits
    - modeling techniques 61
  - electrical conductivity, porous media 234
  - electrical size, modeling 13
  - electromagnetic energy, theory 78
  - electromagnetic heating (node) 281
  - electromagnetic quantities 87
  - electromagnetic sources, applying 31
  - electromagnetic waves asymptotic scattering interface 196
  - electromagnetic waves, boundary elements interface 200, 204
  - electromagnetic waves, frequency domain interface 90, 93
    - theory 217
  - electromagnetic waves, time explicit interface 184
    - theory 240
  - electromagnetic waves, transient interface 169
    - theory 217
  - emailing COMSOL 21
  - emitter node 259
  - error message, electrical circuits 62
  - exponential filter, for wave problems 187
  - exporting
    - SPICE netlists 66
  - external current density (node) 110
  - external I vs. U (node) 262
  - external I-terminal (node) 264
  - external U vs. I (node) 263
- F**
- far field variables 40
  - Faraday's law 240
  - far-field calculation (node) 111, 194, 199, 211
  - far-field calculations 85
  - far-field domain (node) 111, 113, 194
  - far-field variables 38
  - file, Touchstone 99, 178
  - Floquet periodicity 34, 158
  - fluid saturation 167
  - flux/source (node) 192
  - formation factor 235
  - forward-propagating wave 237
  - four-port network (node) 162
  - four-port network port (node) 163
  - free-space variables 104, 210
  - frequency domain equation 218
  - Frequency-Domain Modal Method 69
- G**
- gate node 260
  - Gauss' law 240
  - geometry, simplifying 28
  - ground (node) 126
  - ground node (node) 252
- H**
- H (PEC) symmetry 38
  - high-frequency modeling 13
  - hybrid-mode waves
    - axisymmetric, frequency domain 222
    - axisymmetric, time domain 225
    - in-plane, frequency domain 221
    - in-plane, time domain 224
    - perpendicular 219
- I**
- impedance boundary condition (node) 146
  - importing
    - SPICE netlists 65, 265
  - incoming wave (node) 180
  - inductor (node) 253
  - inhomogeneous materials 79
  - initial values (node) 199

- electromagnetic waves, boundary elements interface 211
- electromagnetic waves, frequency domain interface 110
- electromagnetic waves, time explicit interface 189
- electromagnetic waves, transient 175
- transmission line 180
- in-plane TE waves theory
  - frequency domain 221
  - time domain 225
- in-plane TM waves theory
  - frequency domain 221
  - time domain 225
- inports 117
- integration line for current (node) 126
- integration line for voltage (node) 126
- internet resources 19
- K** Kirchhoff's circuit laws 267
- knowledge base, COMSOL 22
- L** layered impedance boundary condition (node) 155
- layered transition boundary condition (node) 152
- line current (out-of-plane) (node) 166
- linearization point 58
- listener ports 117
- losses, electric 222
- losses, magnetic 224
- lossy eigenvalue calculations 56
- lumped element (node) 137
- lumped port (node) 132, 182, 212
- lumped ports 49–50
- M** magnetic current (node) 159
- magnetic current density (node) 190
- magnetic field (node) 140, 191
- magnetic losses theory 224
- magnetic point dipole (node) 166
- magnetic susceptibility 242
- material properties
  - electromagnetics 79
- materials 80
- Maxwell's equations
  - dielectrics 77
  - electrical circuits and 267
  - theory 74
- Maxwell-Ampere's law 240
- mesh resolution 32
- microwave heating interface 278
- mode analysis 58, 219
- mode phase
  - for Port and Diffraction Order 119
- modeling tips 27
- MPH-files 21
- multiphysics couplings
  - microwave heating 278
- mutual inductance (node) 260
- N** n-Channel MOS transistor 260, 271
- n-Channel MOSFET (node) 260
- netlists, SPICE 65, 265
- nodes, common settings 16
- nonlinear materials 80
- NPN bipolar junction transistor 268
- NPN BJT (node) 259
- numeric modes 116
- O** open circuit (node) 181
- orthogonal polarization (node) 130
- P** p-Channel MOS transistor 260
- p-Channel MOSFET (node) 260
- PEC. see perfect electric conductor
- perfect conductors and dielectrics 77
- perfect electric conductor (node) 190
  - boundaries 113
- perfect magnetic conductor (node) 114,

- 191
- periodic boundary conditions 34
- periodic condition (node) 157
- periodic port reference point (node) 131
- permeability
  - anisotropic 219
- permittivity
  - anisotropic 219
- phasors 81
- physics interfaces, common settings 16
- PMC. *see* perfect magnetic conductor
- PNP BJT (node) 259
- polarization, 2D and 2D axisymmetry 30
- port (node) 115
- port boundary conditions 47
- ports, lumped 49–50
- potentials, scalar and magnetic 77
- power law, porous media
  - conductivity 232
  - permeability 234
  - permittivity 233
- Poynting's theorem 78
- predefined couplings, electrical circuits
  - 62
- propagating waves 237
- propagation constant 237
- Q** quality factor (Q factor) 56, 219
- quasistatic modeling 13
- R** reciprocal permeability, volume average
  - 234
- reciprocal permittivity, volume average
  - 233
- reference point (node) 145
- refractive index 106
- refractive index theory 223
- relative electric field 37
- resistor (node) 252
- S** saturation coefficient 235
- saturation exponent 167
- scattered fields, definition 36
- scattering boundary condition (node)
  - 140, 192
- scattering parameters. *see* S-parameters
- selecting
  - mesh resolution 32
  - solver sequences 32
  - study types 13, 17
- semiconductor device models 268
- short circuit (node) 182
- SI units 87
- simplifying geometries 28
- skin effect, meshes and 32
- solver sequences, selecting 32
- source node 260
- space dimensions 14, 28
- S-parameter calculations
  - electric field, and 46
  - port node and 115
  - theory 82
- spherical waves 141
- SPICE
  - exporting 66
- SPICE netlists 65, 265
- standard settings 16
- study types 13
  - boundary mode analysis 58, 116
  - eigenfrequency 56, 219
  - frequency domain 218
  - mode analysis 58, 219
- subcircuit definition (node) 258
- subcircuit instance (node) 259
- surface current density (node) 148, 191
- surface magnetic current density (node)
  - 148
- surface roughness (node) 149

- switch (node) 257
- symbols for electromagnetic quantities 87
- symmetry axis reference point (node) 145
- symmetry in E (PMC) or H (PEC) 38
- symmetry planes, far-field calculations 38
- symmetry, axial 29
- T**
  - TE axisymmetric waves theory
    - frequency domain 222
    - time domain 225
  - TE waves theory 84
  - technical support, COMSOL 21
  - TEM waves theory 84
  - terminating impedance (node) 181
  - theory
    - constitutive relations 75–76
    - electrical circuit interface 267
    - electromagnetic waves 217
    - electromagnetic waves, time explicit
      - interface 240
    - electromagnetics 74
    - far-field calculations 85
    - lumped ports 50
    - S-parameters 82
    - transmission line 236
  - three-port network (node) 161
  - three-port network port (node) 162
  - time domain equation, theory 224
  - TM waves
    - axisymmetric 218
  - TM waves theory 84
  - Touchstone file 99, 178
  - transformer (node) 261
  - transition boundary condition (node) 150
  - transmission line equation (node) 179
  - transmission line interface 177
    - theory 236
  - TW axisymmetric waves theory
    - frequency domain 222
    - time domain 225
  - two-port network (node) 159
  - two-port network port (node) 160
- U**
  - uniform element (node) 139
  - units, SI 87
- V**
  - variables
    - boundary mode analysis 59
    - eigenfrequency analysis and 57
    - far-field 38
    - for far fields 40
    - Jones vectors 54
    - lumped ports 52
    - mode analysis 59, 220
    - S-parameters 47
  - vector elements theory 226
  - voltage input, ports 49
  - voltage source (node) 253
  - voltage-controlled current source (node) 256
  - voltage-controlled voltage source (node) 255
  - voltmeter (node) 252
  - volume average, permeability 234
  - volume average, permittivity 233
  - volume averages, porous media 232
- W**
  - wave equation, electric (node) 104, 172, 210
    - wave equations (node) 186
  - wave excitation 117
  - wave impedance theory 84
  - wave number, free-space 104, 210
  - wavelength, meshes and 32
  - websites, COMSOL 22