

Self-Focusing

Introduction

For low intensities, the refractive index is independent of the intensity of the light in the material. However, when the intensity is large, so large that the electric field of the light field actually start to perturb the electron clouds around the nuclei, the refractive index start to depend on the intensity. Thus, for dielectrics, like glass, the refractive index increases with the intensity.

When a Gaussian beam propagates through a medium with an intensity-dependent refractive index, the index is highest at the center of the beam. Thus, the induced refractive index profile acts as a lens or a waveguide that counteracts the spreading of the beam due to diffraction. The effect that the beam itself induces this positive, focusing, lens in the material is called self-focusing.

Self-focusing manifests itself both in terms of whole-beam focusing, where the beam's properties are changed by the induced index profile, and by small-scale focusing, where noise across the beam's cross-sectional intensity distribution is amplified and the beam can break up into several self-focused filaments.

The nonlinear refractive index is written as

$$n = n_0 + \gamma I$$

where n_0 is the constant (linear) part of the refractive index, γ is the nonlinear refractive index coefficient and I is the intensity. The nonlinearity is due to the optical Kerr effect, which is a nonlinear distortion of the electron clouds around the nuclei in the material. For the standard optical glass BK-7, the nonlinear coefficient is $4 \cdot 10^{-16} \text{ cm}^2/\text{W}$. Thus, for an intensity of $2.5 \text{ GW}/\text{cm}^2$, the induced refractive index change is 10^{-6} . This is a small change, but it has a significant effect on the beam parameters.

Self-focusing is important from a laser engineering perspective, as the modification of the beam must be incorporated in the design. Furthermore, if the threshold for self-focusing is exceeded, the material is damaged. Thus, it is important to know the self-focusing threshold values for the materials used in the design. Self-focusing occurs in dielectrics, like optical glasses and laser rod materials, such as Nd:YAG.

A first estimate of the threshold power for self-focusing is obtain by assuming that the beam has a circular cross-section with a uniform intensity. Within this beam, the refractive index is higher than outside the beam. Thus, the beam itself induces a waveguide structure. You can equal the acceptance angle of the waveguide with the diffraction angle from the circularly confined light. From this equality, you get the critical power to be

$$P_{cr} = (1.22\pi)^2 \frac{\lambda_0^2}{8\pi n_0 \gamma} \quad (1)$$

Model Definition

The geometry for the model is simple — just a cylinder.

The incident beam is approximated by a Gaussian beam¹, polarized in the z direction. The electric field is given by

$$\mathbf{E}(x, y, z) = E_0 \frac{w_0}{w(x)} \exp\left(-\frac{y^2 + z^2}{w^2(x)}\right) \exp\left(-jk \frac{y^2 + z^2}{2R(x)}\right) \exp(-j(kx - \eta(x))) \mathbf{z}$$

where E_0 is the electric field amplitude, w_0 is the spot radius at the waist, k is the wave number, defined by $k = 2\pi n_0/\lambda$, and \mathbf{z} is the unit vector in the z direction. The function $w(x)$ defines the spot size variation as a function of the distance from the beam waist,

$$w(x) = w_0 \sqrt{1 + \frac{x^2}{x_0^2}} \quad (2)$$

where $x_0 = \pi n_0 w_0^2/\lambda$ is the Rayleigh range. The radius of curvature is defined by

$$R(x) = x \left(1 + \frac{x_0^2}{x^2}\right)$$

and the phase change close to the beam waist, the so-called Gouy shift, is defined by

$$\eta(x) = \text{atan}\left(\frac{x}{x_0}\right)$$

1. Notice that the Gaussian beam expression used here is not a solution to Maxwell's equations, but to the approximate paraxial wave equation. Thus, it should not be used for beams with spot radii of the same size as or smaller than the wavelength.

Results and Discussion

Figure 1 shows the Gaussian beam for a low input intensity. As expected, the beam is symmetric around the beam waist location.

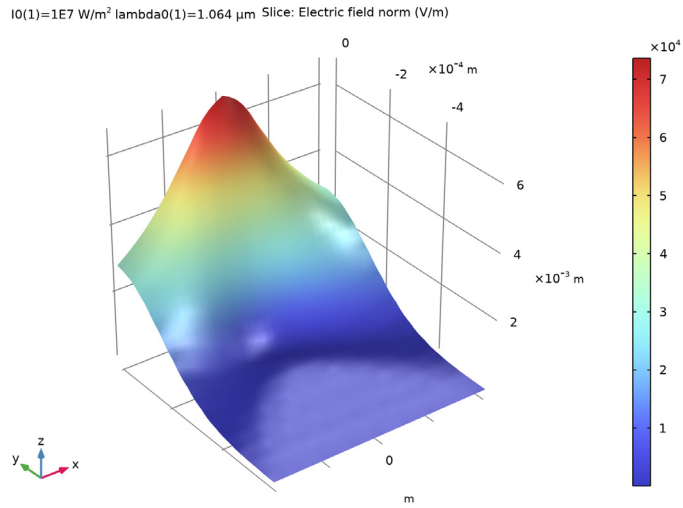

Figure 1: The Gaussian beam for a low peak intensity, $I_0 = 1 \text{ kW/cm}^2$.

Figure 2 shows the beam for a high input intensity, $I_0 = 14 \text{ GW/cm}^2$. The nominal induced refractive index, γI_0 , is 5.6×10^{-6} . As noted from Figure 3 the actual induced

refractive index is much larger than the nominal value. This is of course an effect of the self-focusing of the beam.

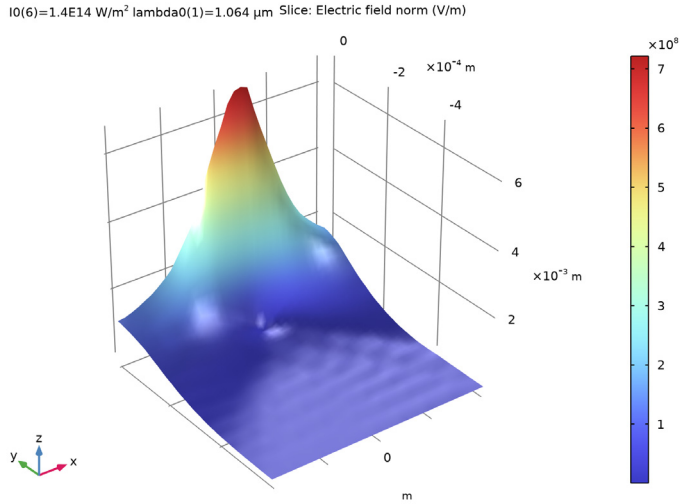

Figure 2: The Gaussian beam for a high peak intensity, $I_0 = 14 \text{ GW/cm}^2$.

To demonstrate the effect of self-focusing, Figure 4 shows the calculated spot radius at the boundary between the propagation domain and the PML domain. The spot radius is defined by

$$w = \sqrt{\frac{2 \int_A I(y, z)(y^2 + z^2) dy dz}{\int_A I(y, z) dy dz}} \quad (3)$$

where A is the integration area and $I(y, z)$ is the cross-sectional intensity distribution of the beam. For low peak intensities, the calculated spot radius, using Equation 3, give similar results as the Gaussian beam expression in Equation 2. However, with increasing

intensities, the beam start to deviate from a Gaussian beam and the spot radius is reduced linearly with intensity.

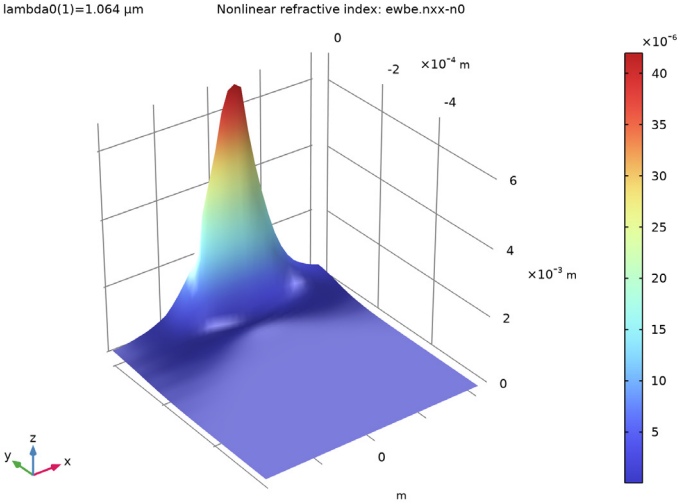

Figure 3: The induced refractive index change, γI , for a high peak intensity, $I_0 = 14 \text{ GW/cm}^2$.

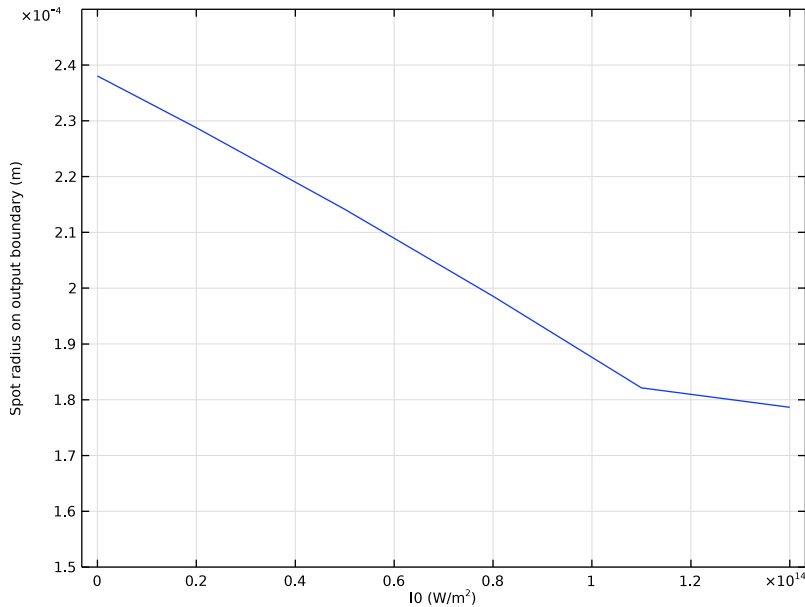

Figure 4: The spot radius at the end of the propagation domain versus the peak intensity.

The final intensity used in the parametric sweep is 14 GW/cm^2 . This corresponds to a power that is 23% of the critical power, provided in Equation 1. As discussed in Ref. 1, it is expected that the critical power for a Gaussian beam is reduced by a factor of approximately $4/(1.22\pi)^2 = 0.27$. Thus, the power corresponding to the last peak intensity in the sweep is approximately a factor $0.23/0.27 = 0.85$ from the critical power for self-focusing for a Gaussian beam, where the induced refractive index profile completely balances the diffractive spreading of the beam.

To compute the field for even higher intensities, a much finer mesh would be needed, as the beam can break up into filaments. For a nonlinear problem like this, it is important to verify the results by, for instance, repeating the simulation with a finer mesh.

Reference

-
1. W. Koechner, *Solid-State Laser Engineering*, Springer, chap. 4.6, 2010.

Application Library path: Wave_Optics_Module/Nonlinear_Optics/
self_focusing



Modeling Instructions

From the **File** menu, choose **New**.

NEW

In the **New** window, click  **Model Wizard**.

MODEL WIZARD

- 1 In the **Model Wizard** window, click .
- 2 In the **Select Physics** tree, select **Optics>Wave Optics>Electromagnetic Waves, Beam Envelopes (ewbe)**.
- 3 Click **Add**.
- 4 Click  **Study**.
- 5 In the **Select Study** tree, select **Preset Studies for Selected Physics Interfaces>Wavelength Domain**.
- 6 Click  **Done**.

GLOBAL DEFINITIONS

Start by adding some global model parameters.

Parameters 1

- 1 In the **Model Builder** window, under **Global Definitions** click **Parameters 1**.
- 2 In the **Settings** window for **Parameters**, locate the **Parameters** section.
- 3 In the table, enter the following settings:

Name	Expression	Value	Description
lda0	1.064 [um]	1.064E-6 m	Wavelength
w0	100*lda0	1.064E-4 m	Nominal spot radius
n0	1.52	1.52	Refractive index of BK-7 glass
x0	$\pi \cdot n0 \cdot w0^2 / lda0$	0.050808 m	Rayleigh range
k	$2 \cdot \pi \cdot n0 / lda0$	8.976E6 1/m	Propagation constant

Name	Expression	Value	Description
I0	2.5[GW/cm ²]	2.5E13 W/m ²	Nominal peak intensity
E0	$\sqrt{2 \cdot I_0 / n_0} \cdot \sqrt{\mu_0 \cdot \text{const} / \epsilon_0 \cdot \text{const}}$	1.1132E8 V/m	Nominal peak electric field
length	4*x0	0.20323 m	Length of computation domain
radius	$2.5 \cdot w_0 \cdot \sqrt{1 + (\text{length} / (2 \cdot x_0))^2}$	5.9479E-4 m	Radius of computation domain
gamma	4e-16[cm ² /W]	4E-20 s ³ /kg	Nonlinear refractive index coefficient
delta_n	gamma*I0	1E-6	Nominal refractive index change
P_cr	$(1.22 \cdot \pi)^2 \cdot \text{lda}^0^2 / (8 \cdot \pi \cdot n_0 \cdot \text{gamma})$	1.0883E7 W	Critical power

GEOMETRY I

Cylinder 1 (cyl1)



- 1 In the **Geometry** toolbar, click  **Cylinder**.
- 2 In the **Settings** window for **Cylinder**, locate the **Size and Shape** section.
- 3 In the **Radius** text field, type radius.
- 4 In the **Height** text field, type length.
- 5 Locate the **Position** section. In the **x** text field, type -length/2.
- 6 Locate the **Axis** section. From the **Axis type** list, choose **x-axis**.

Block 1 (blk1)

Since the planes $y = 0$ and $z = 0$ should be symmetry planes for the beam, we only need to model one fourth of the beam. Thus, add a block that intersect one quadrant of the cylinder.

- 1 In the **Geometry** toolbar, click  **Block**.
- 2 In the **Settings** window for **Block**, locate the **Size and Shape** section.
- 3 In the **Width** text field, type length.
- 4 In the **Depth** text field, type radius.
- 5 In the **Height** text field, type radius.
- 6 Locate the **Position** section. In the **x** text field, type -length/2.
- 7 In the **y** text field, type -radius.

Intersection 1 (int1)

- 1 In the **Geometry** toolbar, click  **Booleans and Partitions** and choose **Intersection**.
- 2 Click in the **Graphics** window and then press Ctrl+A to select both objects.
- 3 In the **Geometry** toolbar, click  **Build All**.



GLOBAL DEFINITIONS

Since the geometry is so long and thin, modify the view settings to not preserve the aspect ratio.

DEFINITIONS

In the **Model Builder** window, expand the **Component 1 (comp1)>Definitions** node.

Camera

- 1 In the **Model Builder** window, expand the **Component 1 (comp1)>Definitions>View 1** node, then click **Camera**.
- 2 In the **Settings** window for **Camera**, locate the **Camera** section.
- 3 From the **View scale** list, choose **Automatic**.
- 4 From the **Automatic** list, choose **Anisotropic**.
- 5 Select the **Automatic update** check box.
- 6 Click  **Update**.
- 7 Click the  **Zoom Extents** button in the **Graphics** toolbar.

MATERIALS

Now add the BK-7 glass used in the model.

BK-7 glass

- 1 In the **Model Builder** window, under **Component 1 (comp1)** right-click **Materials** and choose **Blank Material**.
- 2 In the **Settings** window for **Material**, type BK-7 glass in the **Label** text field.
- 3 Locate the **Material Contents** section. In the table, enter the following settings:

Property	Variable	Value	Unit	Property group
Refractive index, real part	n_iso ; nij = n_iso, nij = 0	n0+gamma* ewbe.Poavx	1	Refractive index

The variable `ewbe.Poavx` represents the intensity in the propagation direction.

DEFINITIONS

Setup a boundary integration operator, for calculation of the output power and the output spot radius.

Integration 1 (intop1)

- 1 In the **Definitions** toolbar, click  **Nonlocal Couplings** and choose **Integration**.
- 2 In the **Settings** window for **Integration**, type intop_output_boundary in the **Operator name** text field.
- 3 Locate the **Source Selection** section. From the **Geometric entity level** list, choose **Boundary**.
- 4 Select Boundary 5 only.

Variables 1

Add the expressions for the output power and the output spot radius.

- 1 In the **Definitions** toolbar, click  **Local Variables**.
- 2 In the **Settings** window for **Variables**, locate the **Variables** section.
- 3 In the table, enter the following settings:

Name	Expression	Unit	Description
P	intop_output_boundary(ewbe.nPoav)	W	Output power
w_t	$\sqrt{2 * \text{intop_output_boundary}(ewbe.nPoav * (y^2 + z^2)) / P}$	m	Spot radius on output boundary

ELECTROMAGNETIC WAVES, BEAM ENVELOPES (EWBE)

Set the interface to use unidirectional propagation and define the wave vector component in the x direction.

- 1 In the **Model Builder** window, under **Component 1 (comp1)** click **Electromagnetic Waves, Beam Envelopes (ewbe)**.
- 2 In the **Settings** window for **Electromagnetic Waves, Beam Envelopes**, locate the **Wave Vectors** section.
- 3 From the **Number of directions** list, choose **Unidirectional**.
- 4 Specify the \mathbf{k}_1 vector as

\mathbf{k}_1	x
----------------	-----

0	y
0	z

Use a matched boundary condition to launch an incident Gaussian beam polarized in the z direction.

Matched Boundary Condition 1

- 1 In the **Physics** toolbar, click  **Boundaries** and choose **Matched Boundary Condition**.
- 2 Select Boundary 1 only.
- 3 In the **Settings** window for **Matched Boundary Condition**, locate the **Matched Boundary Condition** section.
- 4 From the **Incident field** list, choose **Gaussian beam**.
- 5 In the w_0 text field, type w_0 .
- 6 In the p_0 text field, type $\text{length}/2$.
- 7 From the **Input quantity** list, choose **Power**.
- 8 In the P text field, type $\pi \cdot w_0^2 / 2 \cdot I_0$.
- 9 Specify the \mathbf{E}_{g0} vector as

0	x
0	y
1 [V/m]	z

Add a reference point that together with the propagation direction defines the optical axis.

Reference Point 1

- 1 In the **Physics** toolbar, click  **Attributes** and choose **Reference Point**.
- 2 Select Point 2 only, that is the point on the optical axis (where $y = 0$ and $z = 0$). The focal point is located the distance p_0 from this reference point in the propagation direction, defined by $\text{ewbe} \cdot k_1$.

Matched Boundary Condition 2

- 1 In the **Physics** toolbar, click  **Boundaries** and choose **Matched Boundary Condition**.
- 2 Select Boundary 5 only.

Symmetry Plane 1

Add a perfect magnetic conductor symmetry plane on the plane $y = 0$ and a perfect electric conductor symmetry plane on the plane $z = 0$.

- 1 In the **Physics** toolbar, click  **Boundaries** and choose **Symmetry Plane**.

2 Select Boundary 4 only.

Symmetry Plane 2

1 In the **Physics** toolbar, click  **Boundaries** and choose **Symmetry Plane**.

2 Select Boundary 2 only.

3 In the **Settings** window for **Symmetry Plane**, locate the **Symmetry Plane** section.

4 From the **Symmetry type** list, choose **Zero tangential electric field (PEC)**.

MESH 1

The physics-controlled meshing cannot handle the nonlinear refractive index defined for the BK-7 material. Thus, create a custom mesh. First create a triangular mesh on the input boundary and then a swept mesh for the domain.

Free Triangular 1

In the **Mesh** toolbar, click  **Boundary** and choose **Free Triangular**.

Size

Set the main **Size** settings to represent the discretization along the propagation direction. Since the beam is expected to behave as a slightly distorted Gaussian beam, it is sufficient to set the maximum mesh element size to half the Rayleigh range.

1 In the **Model Builder** window, click **Size**.

2 In the **Settings** window for **Size**, locate the **Element Size** section.

3 Click the **Custom** button.

4 Locate the **Element Size Parameters** section. In the **Maximum element size** text field, type $x0/2$.

Free Triangular 1

1 In the **Model Builder** window, click **Free Triangular 1**.

2 Select Boundary 1 only.

Size 1

1 Right-click **Free Triangular 1** and choose **Size**.

The triangular mesh should resolve the beam cross-sectional distribution.

2 In the **Settings** window for **Size**, locate the **Element Size** section.

3 Click the **Custom** button.

4 Locate the **Element Size Parameters** section.

5 Select the **Maximum element size** check box. In the associated text field, type $w0/2$.

- 6 Select the **Minimum element size** check box. In the associated text field, type $w0/4$.
Create a swept mesh in the propagation direction.

Swept 1

- 1 In the **Mesh** toolbar, click  **Swept**.
- 2 In the **Model Builder** window, right-click **Mesh 1** and choose **Build All**.

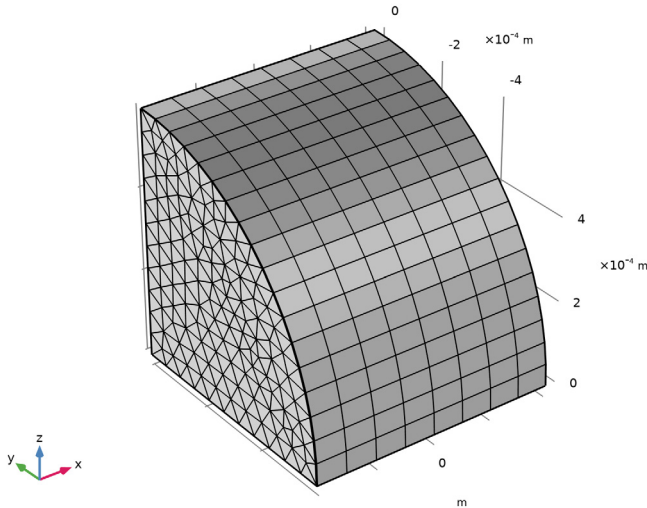

STUDY 1

Do not generate the default plots.



- 1 In the **Model Builder** window, click **Study 1**.
- 2 In the **Settings** window for **Study**, locate the **Study Settings** section.
- 3 Clear the **Generate default plots** check box.

Step 1: Wavelength Domain

- 1 In the **Model Builder** window, under **Study 1** click **Step 1: Wavelength Domain**.
- 2 In the **Settings** window for **Wavelength Domain**, locate the **Study Settings** section.
- 3 In the **Wavelengths** text field, type $1\text{da}0$.

Parametric Sweep

Set up a parametric sweep of the nominal peak intensity, from 1 kW/cm^2 (corresponding to linear propagation) to 14 GW/cm^2 that will show a significant self-focusing effect.



- 1 In the **Study** toolbar, click  **Parametric Sweep**.
- 2 In the **Settings** window for **Parametric Sweep**, locate the **Study Settings** section.
- 3 Click  **Add**.
- 4 In the table, enter the following settings:

Parameter name	Parameter value list	Parameter unit
10 (Nominal peak intensity)	1e7, 2e13, 5e13, 8e13, 11e13, 14e13	W/m ²

- 5 Click to expand the **Advanced Settings** section. From the **Use parametric solver** list, choose **Off**, to turn off the parametric solver that otherwise would perform calculations also for intermediate intensities.

Solution 1 (sol1)

Since this is a nonlinear problem, it is better to split the complex electric field variable into its real and imaginary parts. This will produce a more accurate Jacobian for the problem, leading to a faster convergence.

- 1 In the **Study** toolbar, click  **Show Default Solver**.
- 2 In the **Model Builder** window, expand the **Solution 1 (sol1)** node, then click **Compile Equations: Wavelength Domain**.
- 3 In the **Settings** window for **Compile Equations**, locate the **Study and Step** section.
- 4 Select the **Split complex variables in real and imaginary parts** check box.
- 5 In the **Study** toolbar, click  **Compute**.

RESULTS

3D Plot Group 1

- 1 In the **Home** toolbar, click  **Add Plot Group** and choose **3D Plot Group**.
- 2 In the **Settings** window for **3D Plot Group**, locate the **Data** section.
- 3 From the **Dataset** list, choose **Study 1/Parametric Solutions 1 (sol2)**.



Slice 1

- 1 Right-click **3D Plot Group 1** and choose **Slice**.
- 2 In the **Settings** window for **Slice**, locate the **Plane Data** section.
- 3 From the **Plane** list, choose **XY-planes**.
- 4 From the **Entry method** list, choose **Coordinates**.

Deformation 1

- 1 Right-click **Slice 1** and choose **Deformation**.
- 2 In the **Settings** window for **Deformation**, locate the **Expression** section.
- 3 In the **Z-component** text field, type `ewbe.normE`.







3D Plot Group 1

- 1 In the **Model Builder** window, under **Results** click **3D Plot Group 1**.
- 2 In the **Settings** window for **3D Plot Group**, locate the **Plot Settings** section.
- 3 Clear the **Plot dataset edges** check box.
- 4 Click the  **Go to Default View** button in the **Graphics** toolbar.
Take a look at the field distributions for the different intensities.
- 5 Locate the **Data** section. From the **Parameter value (10 (W/m²))** list, choose **1E7**.
- 6 In the **3D Plot Group 1** toolbar, click  **Plot**.

Slice 1

Click the  **Zoom Extents** button in the **Graphics** toolbar. Compare the graph with that in [Figure 1](#).

3D Plot Group 1

- 1 In the **Model Builder** window, click **3D Plot Group 1**.
- 2 In the **Settings** window for **3D Plot Group**, locate the **Data** section.
- 3 From the **Parameter value (10 (W/m²))** list, choose **2E13**.
- 4 In the **3D Plot Group 1** toolbar, click  **Plot**.
- 5 From the **Parameter value (10 (W/m²))** list, choose **5E13**.
- 6 In the **3D Plot Group 1** toolbar, click  **Plot**.
- 7 From the **Parameter value (10 (W/m²))** list, choose **8E13**.
- 8 In the **3D Plot Group 1** toolbar, click  **Plot**.
- 9 From the **Parameter value (10 (W/m²))** list, choose **1.1E14**.
- 10 In the **3D Plot Group 1** toolbar, click  **Plot**.
- 11 From the **Parameter value (10 (W/m²))** list, choose **1.4E14**.
- 12 In the **3D Plot Group 1** toolbar, click  **Plot**.
- 13 Click the  **Zoom Extents** button in the **Graphics** toolbar. Compare the graph with that in [Figure 2](#).

Slice 1

To really see how the beam changes with intensity, you can also visualize this by running the 3D plots in the Player.



The first step would be to normalize the field solution with the nominal peak electric field.

- 1 In the **Model Builder** window, click **Slice 1**.
- 2 In the **Settings** window for **Slice**, locate the **Expression** section.
- 3 In the **Expression** text field, type `ewbe.normE/E0`.

Deformation 1

- 1 In the **Model Builder** window, click **Deformation 1**.
- 2 In the **Settings** window for **Deformation**, locate the **Expression** section.
- 3 In the **Z-component** text field, type `ewbe.normE/E0`.

Animation 1

- 1 In the **Results** toolbar, click  **Animation** and choose **File**.
- 2 In the **Settings** window for **Animation**, locate the **Target** section.
- 3 From the **Target** list, choose **Player**.
- 4 Locate the **Animation Editing** section. From the **Loop over** list, choose **I0**.
- 5 Locate the **Playing** section. In the **Display each frame for** text field, type 1.
- 6 Click the  **Play** button in the **Graphics** toolbar.

If you check the **Repeat** box in the **Playing** settings, you can have the Player repeat the sequence.

3D Plot Group 2

Now create a new plot of the refractive index change induced by the beam.

In the **Results** toolbar, click  **3D Plot Group**.

Slice 1





- 1 Right-click **3D Plot Group 2** and choose **Slice**.
- 2 In the **Settings** window for **Slice**, locate the **Plane Data** section.
- 3 From the **Plane** list, choose **XY-planes**.
- 4 From the **Entry method** list, choose **Coordinates**.
- 5 Locate the **Expression** section. In the **Expression** text field, type `ewbe.nxx-n0`.

Deformation 1

- 1 Right-click **Slice 1** and choose **Deformation**.

- 2 In the **Settings** window for **Deformation**, locate the **Expression** section.
- 3 In the **Z-component** text field, type `ewbe.nxx-n0`.

3D Plot Group 2

- 1 In the **Model Builder** window, under **Results** click **3D Plot Group 2**.
- 2 In the **Settings** window for **3D Plot Group**, locate the **Plot Settings** section.
- 3 Clear the **Plot dataset edges** check box.
- 4 Click to expand the **Title** section. From the **Title type** list, choose **Manual**.
- 5 In the **Title** text area, type `Nonlinear refractive index: ewbe.nxx-n0`.
- 6 In the **3D Plot Group 2** toolbar, click  **Plot**.
- 7 In the **Graphics** window toolbar, click  next to  **Go to Default View**, then choose **Go to View 1**.
- 8 Click the  **Go to Default View** button in the **Graphics** toolbar. Compare your graph with [Figure 3](#).

Global Evaluation 1

Now, visualize how the spot radius decreases with intensity, using a table and a table plot.

- 1 In the **Results** toolbar, click  **Global Evaluation**.
- 2 In the **Settings** window for **Global Evaluation**, locate the **Expressions** section.
- 3 In the table, enter the following settings:

Expression	Unit	Description
w_t	m	Spot radius on output boundary

- 4 Locate the **Data** section. From the **Dataset** list, choose **Study 1/ Parametric Solutions 1 (sol2)**.
- 5 Click  **Evaluate**.

TABLE

- 1 Go to the **Table** window.
- 2 Click **Table Graph** in the window toolbar.

RESULTS

Table Graph 1

- 1 In the **Model Builder** window, under **Results>ID Plot Group 3** click **Table Graph 1**.
- 2 In the **Settings** window for **Table Graph**, locate the **Data** section.

- 3 From the **x-axis data** list, choose **IO (W/m²)**.
- 4 From the **Plot columns** list, choose **Manual**.
- 5 In the **Columns** list, select **Spot radius on output boundary (m)**.

ID Plot Group 3

- 1 In the **Model Builder** window, click **ID Plot Group 3**.
- 2 In the **Settings** window for **ID Plot Group**, locate the **Axis** section.
- 3 Select the **Manual axis limits** check box.
- 4 In the **y minimum** text field, type 1.5e-4.
- 5 In the **y maximum** text field, type 2.5e-4.
- 6 In the **ID Plot Group 3** toolbar, click  **Plot**. Your result should look similar to that in [Figure 4](#).

Global Evaluation 2

Now, compare the result with the output spot radius of the ideal Gaussian beam.

- 1 In the **Results** toolbar, click  **Global Evaluation**.
- 2 In the **Settings** window for **Global Evaluation**, locate the **Expressions** section.
- 3 In the table, enter the following settings:, which is the expression representing the spot

Expression	Unit	Description
$w0 * \sqrt{1 + (\text{length}/2/x0)^2}$	m	

radius at the output boundary for a Gaussian beam within the paraxial approximation.

- 4 Click  **Evaluate**.

TABLE

- 1 Go to the **Table** window.

You should find that the spot radius for the low intensity cases are close to that of the nominal beam.

RESULTS

Finally, compare the total power in the beam with the critical power for self-focusing, as defined in [Figure 4](#).

Global Evaluation 3

- 1 In the **Results** toolbar, click  **Global Evaluation**.
- 2 In the **Settings** window for **Global Evaluation**, locate the **Expressions** section.

3 In the table, enter the following settings:

Expression	Unit	Description
$4*P/P_{cr}$	1	

Here we multiplied the power ratio with 4 since we integrated the power over only a fourth of the beam.

4 Locate the **Data** section. From the **Dataset** list, choose **Study 1/ Parametric Solutions 1 (sol2)**.

5 Click  **Evaluate**.

TABLE

1 Go to the **Table** window.

You should find that the power ratio is approximately 23%.