



# Thermo-Mechanical Analysis of a Surface-Mounted Resistor

## *Introduction*

---

The drive for miniaturizing electronic devices has resulted in today's extensive use of surface-mount electronic components. An important aspect in electronics design and the choice of materials is a product's durability and lifetime. For surface-mount resistors and other components producing heat it is a well-known problem that temperature cycling can lead to cracks propagating through the solder joints, resulting in premature failure ([Ref. 1](#)). For electronics in general there is a strong interest in changing the soldering material from lead- or tin-based solder alloys to other mixtures.

The following multiphysics example models the heat transport and structural stresses and deformations resulting from the temperature distribution using the Heat Transfer in Solids and Solid Mechanics interfaces.

---

**Note:** This application requires either the Structural Mechanics Module or the MEMS Module.

---

## Model Definition

Figure 1 shows a photograph of a surface-mount resistor together with a diagram of it on a printed circuit board (PCB).

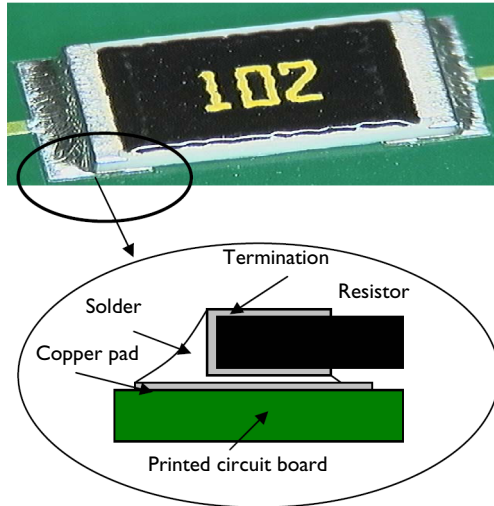

Figure 1: A photo and diagram of a typical surface-mounted resistor soldered to a PCB.

Table 1 shows the dimensions of the resistor and other key components in the model including the PCB.

TABLE 1: COMPONENT DIMENSIONS.

COMPONENT	LENGTH	WIDTH	HEIGHT
Resistor (Alumina)	6 mm	3 mm	0.5 mm
PCB (FR4)	16 mm	8 mm	1.6 mm
Cu pad	2 mm	3 mm	35 $\mu\text{m}$
Termination (Silver)	0.5 mm	3 mm	25 $\mu\text{m}$
Stand-off (gap to PCB)	-	-	105 $\mu\text{m}$

The simulation makes use of the symmetry so that it needs to include only half of the component (Figure 2). The modeling of the PCB is terminated a distance away from the resistor, in order to reduce effects of the boundary conditions.

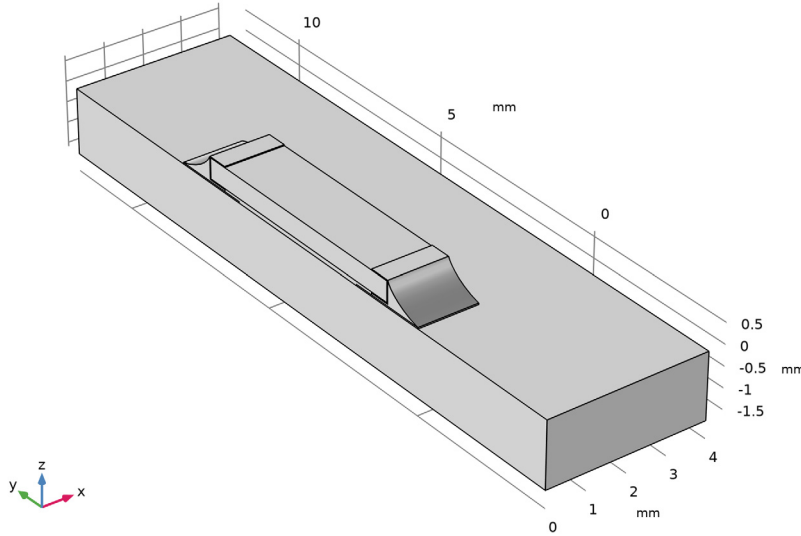

Figure 2: The simulation models only one half of the resistor.

In operation, the resistor dissipates 0.2 W of power as heat. Conduction to the PCB and convection to the surrounding air provide cooling. In this model, the heat transfer occurs through conduction in the subdomains. The model simplifies the surface cooling and describes it using a heat transfer coefficient,  $h$ , in this case set to  $10 \text{ W}/(\text{m}^2 \cdot \text{K})$ ; the surrounding air temperature,  $T_{\text{inf}}$ , is at 300 K. The resulting heat transfer equation and boundary condition (included in the model using the Heat Transfer interface) are

$$\nabla \cdot (-k \nabla T) = Q$$

$$-\mathbf{n} \cdot (-k \nabla T) = h(T_{\text{inf}} - T)$$

where  $k$  is the thermal conductivity, and  $Q$  is the heating power per unit volume of the resistor (equal to  $22.2 \text{ MW}/\text{m}^3$  corresponding to 0.2 W in total).

The model handles thermal expansion using a static structural analysis using the Structural Mechanics interface (a description of the corresponding equations is available in the *Structural Mechanics Module User's Guide*). The thermal and mechanical material

properties in this model are taken from the material library. The data for the solid materials are temperature independent, and the reference values are shown in the table below.

TABLE 2: MATERIAL PROPERTIES.

<b>MATERIAL</b>	$E$ (GPa)	$\nu$	$\alpha$ (ppm)	$k$ (W/(m·K))	$\rho$ (kg/m <sup>3</sup> )	$C_p$ (J/(kg·K))
Silver	83	0.37	18.9	420	10500	230
Alumina	300	0.222	8.0	27	3900	900
Cu	110	0.35	17	400	8700	385
Fr4	22	0.28	18	0.3	1900	1369
60Sn-40Pb	10	0.4	21	50	9000	150

Air has temperature-dependent and pressure-dependent properties in the built-in material library. Because the temperature is a variable of the problem, it is automatically used. The pressure is by default set to 1 atm.

The stresses are zero at room temperature, 293 K. The boundary condition for the Solid Mechanics interface is that the cuts in the PCB do not rotate and have no net force normal to the cut.

## Results and Discussion

The isosurfaces in [Figure 3](#) show the temperature distribution at steady state. The highest temperature occurs in the center of the resistor. The circuit board also heats up significantly.

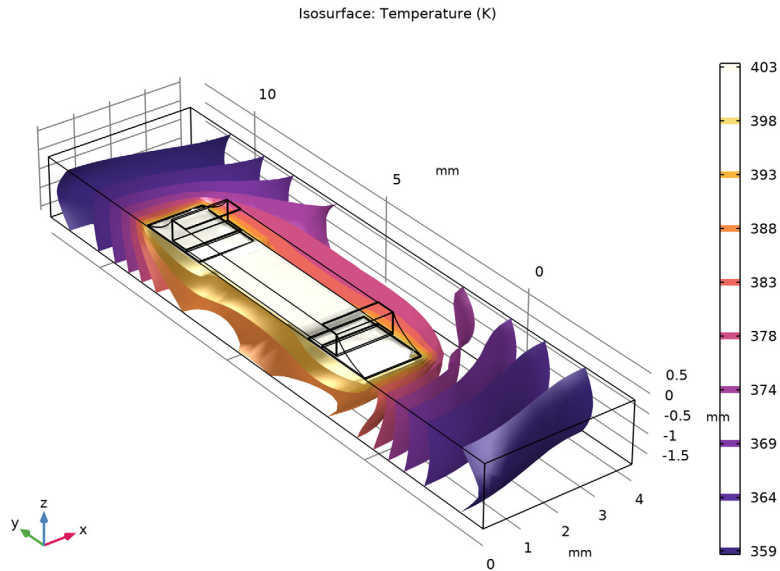

*Figure 3: Temperature distribution in the resistor and the circuit board at steady state.*

Thermal stresses appear as a result of the temperature increase; they arise from the materials' different expansion coefficients and from the bending of the PCB. [Figure 4](#) plots the equivalent stress (von Mises) together with the resulting deformation of the assembly.

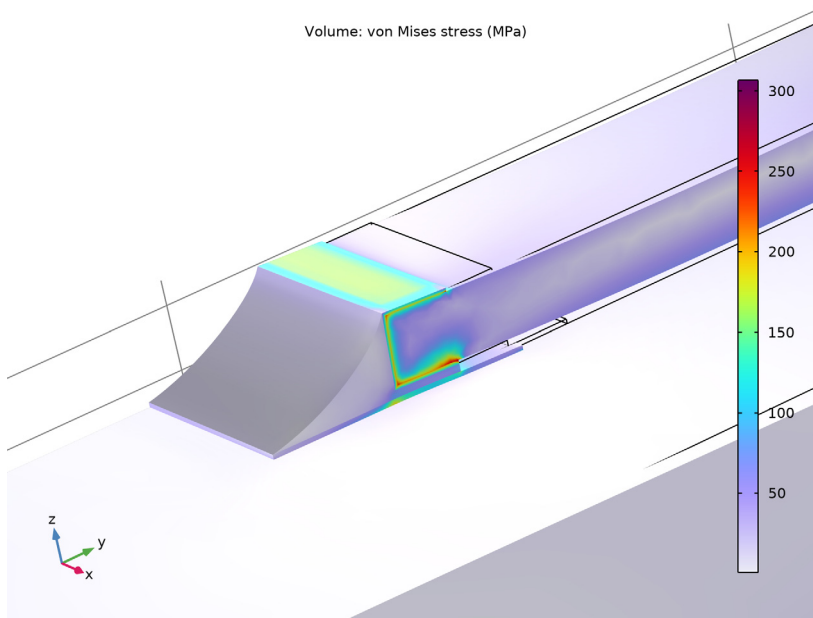

*Figure 4: The thermally induced distribution of von Mises stress together with the deformation (magnified).*

The highest stresses seem to occur in the termination material. It is interesting to compare these equivalent stresses to the yield stress and thereby investigate whether or not the material is irreversibly deformed. In that case the solder is the weak point. [Figure 5](#) the stress in the solder alone.

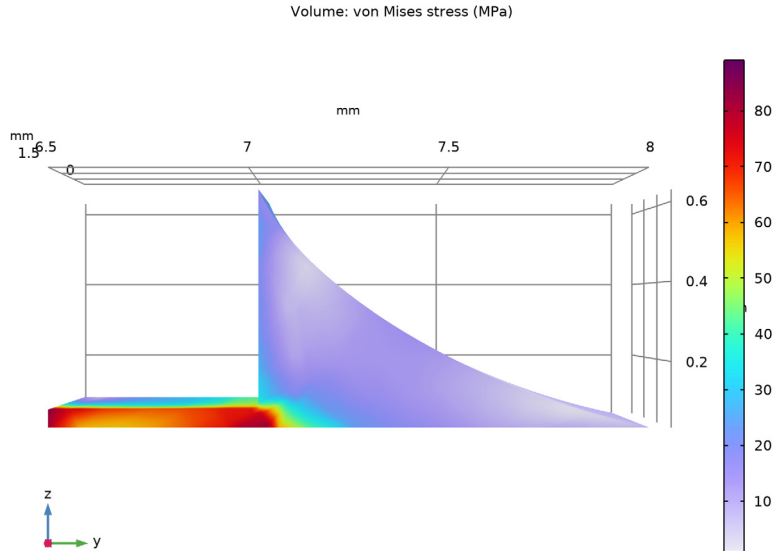

*Figure 5: Close-up of the von Mises stress in the solder joints.*

The yield stress for solder is approximately 220 MPa. The highest equivalent stress appears to be about 40 percent of this value. The structure does not get permanently deformed directly when heated. However, it is possible that the solder displays creep strains over time because of the combination of fairly high stress levels and elevated temperatures.

### *Notes About the COMSOL Implementation*

In this example, the Thermal Stress interface automatically adds and couples the Solid Mechanics interface and the Heat Transfer interface. This is done by the predefined multiphysics feature **Thermal Expansion**.

Build the geometry as an assembly of the bottom plate and the resistor to make it possible to mesh the parts independently. Use continuity conditions for the temperature and the displacements to connect the top and bottom parts of the geometry.

It is assumed that the temperature gradient in the normal direction on the cuts in the PCB is zero. The mechanical boundary conditions on the cuts must not impose a general state of compressive stress due to thermal expansion. At the same time, the restraint from the part of the PCB that is not modeled means that there is no rotation of the cross section.



To obtain this effect, the entire cut must have the same (but unknown) displacement in the direction normal to the cut. This can be achieved by using a special setting in the **Symmetry** condition which allows a translation normal to the symmetry plane.

You solve the problem sequentially using two stationary study steps. The heat transfer problem is nonlinear because the air has temperature-dependent properties. The structural problem, on the other hand, is linear. For the structural analysis, use a memory-efficient iterative solver to make it possible to solve the problem also on computers with limited memory.

### *References*

---

1. H. Lu, C. Bailey, M. Dusek, C. Hunt, and J. Nottay, “Modeling the Fatigue Life of Solder Joints of Surface Mount Resistors,” EMAP, 2000.
2. J.M. Coulson and J.F. Richardson, *Chemical Engineering*, vol. 1, Pergamon Press, appendix, 1990.

---

**Application Library path:** Structural\_Mechanics\_Module/Thermal-Structure\_Interaction/surface\_resistor

---

### *Modeling Instructions*



---

From the **File** menu, choose **New**.

#### **NEW**

In the **New** window, click  **Model Wizard**.

#### **MODEL WIZARD**

- 1 In the **Model Wizard** window, click  **3D**.
- 2 In the **Select Physics** tree, select **Structural Mechanics>Thermal-Structure Interaction>Thermal Stress, Solid**.
- 3 Click **Add**.
- 4 Click  **Study**.
- 5 In the **Select Study** tree, select **General Studies>Stationary**.
- 6 Click  **Done**.

## GLOBAL DEFINITIONS

### Parameters 1

- 1 In the **Model Builder** window, under **Global Definitions** click **Parameters 1**.
- 2 In the **Settings** window for **Parameters**, locate the **Parameters** section.
- 3 In the table, enter the following settings:

Name	Expression	Value	Description
T_air	300[K]	300 K	Air temperature
h_air	10[W/(m <sup>2</sup> *K)]	10 W/(m <sup>2</sup> *K)	Heat transfer coefficient
Psource	0.2[W]/2	0.1 W	Heat dissipated by the resistor on the half geometry
p0	1[atm]	1.0133E5 Pa	Air pressure
T0	80[degC]	353.15 K	Initial temperature guess

## GEOMETRY 1

- 1 In the **Model Builder** window, under **Component 1 (comp1)** click **Geometry 1**.
- 2 In the **Settings** window for **Geometry**, locate the **Units** section.
- 3 From the **Length unit** list, choose **mm**.

Create the geometry. To simplify this step, insert a prepared 2D geometry sequence. On the **Geometry** toolbar, click **Insert Sequence**. Browse to the model's Application Library folder and double-click the file `surface_resistor.mph`.

*Work Plane 1 (wp1)>Plane Geometry*

- 1 In the **Model Builder** window, under **Component 1 (comp1)>Geometry 1>Work Plane 1 (wp1)** click **Plane Geometry**.

The 2D geometry should now look as in the figure below.

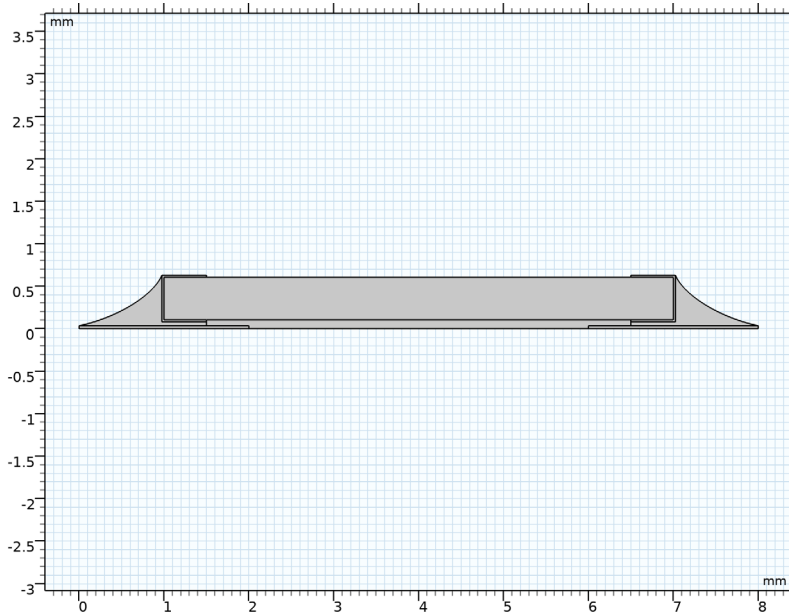

*Extrude 1 (ext1)*



- 1 In the **Model Builder** window, under **Component 1 (comp1)>Geometry 1** right-click **Work Plane 1 (wp1)** and choose **Extrude**.
- 2 Select the object **wp1** only.
- 3 In the **Settings** window for **Extrude**, locate the **Distances** section.
- 4 In the table, enter the following settings:

Distances (mm)
1.5

- 5 Click  **Build All Objects**.

*Block 1 (blk1)*

- 1 In the **Geometry** toolbar, click  **Block**.
- 2 In the **Settings** window for **Block**, locate the **Size and Shape** section.

- 3 In the **Width** text field, type 4.
- 4 In the **Depth** text field, type 16.
- 5 In the **Height** text field, type 1.6.
- 6 Locate the **Position** section. In the **y** text field, type -4.
- 7 In the **z** text field, type -1.6.
- 8 Click  **Build All Objects**.
- 9 Click the  **Zoom Extents** button in the **Graphics** toolbar.

Now, create an imprint of the resistor's bottom boundary on the printed circuit board to make a pair with matching parts.

#### *Form Union (fin)*

- 1 In the **Model Builder** window, under **Component 1 (comp1)>Geometry 1** click **Form Union (fin)**.
- 2 In the **Settings** window for **Form Union/Assembly**, locate the **Form Union/Assembly** section.
- 3 From the **Action** list, choose **Form an assembly**.
- 4 Select the **Create imprints** check box.
- 5 In the **Geometry** toolbar, click  **Build All**.

The completed geometry is shown in [Figure 2](#).

#### **ADD MATERIAL**

- 1 In the **Home** toolbar, click  **Add Material** to open the **Add Material** window.
- 2 Go to the **Add Material** window.
- 3 In the tree, select **Built-in>FR4 (Circuit Board)**.
- 4 Click **Add to Component** in the window toolbar.
- 5 In the tree, select **Built-in>Alumina**.
- 6 Click **Add to Component** in the window toolbar.
- 7 In the tree, select **Built-in>Copper**.
- 8 Click **Add to Component** in the window toolbar.
- 9 In the tree, select **Material Library>Elements>Silver>Silver [solid]>Silver [solid,annealed]**.
- 10 Click **Add to Component** in the window toolbar.
- 11 In the tree, select **Built-in>Solder, 60Sn-40Pb**.
- 12 Click **Add to Component** in the window toolbar.
- 13 In the tree, select **Built-in>Air**.

14 Click **Add to Component** in the window toolbar.

15 In the **Home** toolbar, click  **Add Material** to close the **Add Material** window.

## MATERIALS

*FR4 (Circuit Board) (mat1)*

1 In the **Model Builder** window, under **Component 1 (comp1)>Materials** click **FR4 (Circuit Board) (mat1)**.

2 In the **Settings** window for **Material**, locate the **Geometric Entity Selection** section.

3 From the **Selection** list, choose **Manual**.

4 Click  **Clear Selection**.

5 Select Domain 1 only.

*Alumina (mat2)*

1 In the **Model Builder** window, click **Alumina (mat2)**.

2 Select Domain 5 only.

*Copper (mat3)*

1 In the **Model Builder** window, click **Copper (mat3)**.

2 Select Domains 2 and 7 only.

*Silver [solid,annealed] (mat4)*

1 In the **Model Builder** window, click **Silver [solid,annealed] (mat4)**.

2 Select Domains 4 and 9 only.

*Solder, 60Sn-40Pb (mat5)*

1 In the **Model Builder** window, click **Solder, 60Sn-40Pb (mat5)**.

2 Select Domains 3 and 8 only.

*Air (mat6)*

1 In the **Model Builder** window, click **Air (mat6)**.

2 Select Domain 6 only.

## DEFINITIONS

*Symmetry Plane*

1 In the **Definitions** toolbar, click  **Box**.

2 In the **Settings** window for **Box**, type **Symmetry Plane** in the **Label** text field.

3 Locate the **Geometric Entity Level** section. From the **Level** list, choose **Boundary**.

- 4 Locate the **Box Limits** section. In the **x maximum** text field, type 0.1.
- 5 Locate the **Output Entities** section. From the **Include entity if** list, choose **Entity inside box**.

### **SOLID MECHANICS (SOLID)**

- 1 In the **Model Builder** window, under **Component 1 (comp1)** click **Solid Mechanics (solid)**.
- 2 Select Domains 1–5 and 7–9 only.

#### *Symmetry 1*

- 1 In the **Physics** toolbar, click  **Boundaries** and choose **Symmetry**.
- 2 In the **Settings** window for **Symmetry**, locate the **Boundary Selection** section.
- 3 From the **Selection** list, choose **Symmetry Plane**.

#### *Roller 1*

- 1 In the **Physics** toolbar, click  **Boundaries** and choose **Roller**.
- 2 Select Boundary 8 only.

#### *Symmetry 2*

- 1 In the **Physics** toolbar, click  **Boundaries** and choose **Symmetry**.
- 2 Select Boundary 2 only.
- 3 In the **Settings** window for **Symmetry**, click to expand the **Normal Direction Condition** section.
- 4 From the list, choose **Free displacement**.

#### *Symmetry 3*

- 1 In the **Physics** toolbar, click  **Boundaries** and choose **Symmetry**.
- 2 Select Boundary 9 only.
- 3 In the **Settings** window for **Symmetry**, locate the **Normal Direction Condition** section.
- 4 From the list, choose **Free displacement**.

#### *Prescribed Displacement 1*

- 1 In the **Physics** toolbar, click  **Points** and choose **Prescribed Displacement**.
- 2 Select Point 1 only.
- 3 In the **Settings** window for **Prescribed Displacement**, locate the **Prescribed Displacement** section.
- 4 Select the **Prescribed in z direction** check box.

## HEAT TRANSFER IN SOLIDS (HT)

In the **Model Builder** window, under **Component 1 (comp1)** click **Heat Transfer in Solids (ht)**.

### *Fluid 1*

- 1 In the **Physics** toolbar, click  **Domains** and choose **Fluid**.
- 2 Select Domain 6 only.

### *Heat Source 1*

- 1 In the **Physics** toolbar, click  **Domains** and choose **Heat Source**.
- 2 Select Domain 5 only.
- 3 In the **Settings** window for **Heat Source**, locate the **Heat Source** section.
- 4 From the **Heat source** list, choose **Heat rate**.
- 5 In the  $P_0$  text field, type Psource.

### *Heat Flux 1*

- 1 In the **Physics** toolbar, click  **Boundaries** and choose **Heat Flux**.
- 2 Select Boundaries 3, 4, 11, 14, 19, 29, 30, 44, 46, and 49–58 only.
- 3 In the **Settings** window for **Heat Flux**, locate the **Heat Flux** section.
- 4 From the **Flux type** list, choose **Convective heat flux**.
- 5 In the  $h$  text field, type h\_air.
- 6 In the  $T_{\text{ext}}$  text field, type T\_air.

Because the material properties are temperature dependent, the solution converges better if you supply an initial guess of the temperature.

### *Initial Values 1*

- 1 In the **Model Builder** window, click **Initial Values 1**.
- 2 In the **Settings** window for **Initial Values**, locate the **Initial Values** section.
- 3 In the  $T$  text field, type T0.

## MESH 1

### *Free Triangular 1*

- 1 In the **Mesh** toolbar, click  **Boundary** and choose **Free Triangular**.
- 2 Select Boundaries 10, 13, 16, 20, 24, 33, 37, and 40 only.

### *Size 1*

- 1 Right-click **Free Triangular 1** and choose **Size**.

- 2 In the **Settings** window for **Size**, locate the **Element Size** section.
- 3 From the **Predefined** list, choose **Fine**.
- 4 Click the **Custom** button.
- 5 Locate the **Element Size Parameters** section.
- 6 Select the **Minimum element size** check box. In the associated text field, type 0.1.
- 7 Click  **Build Selected**.

#### *Swept I*

- 1 In the **Mesh** toolbar, click  **Swept**.
- 2 In the **Settings** window for **Swept**, locate the **Domain Selection** section.
- 3 From the **Geometric entity level** list, choose **Domain**.
- 4 Select Domains 2–9 only.

#### *Distribution I*

- 1 Right-click **Swept I** and choose **Distribution**.
- 2 In the **Settings** window for **Distribution**, locate the **Distribution** section.
- 3 In the **Number of elements** text field, type 10.
- 4 Click  **Build All**.

#### *Free Tetrahedral I*

In the **Mesh** toolbar, click  **Free Tetrahedral**.

#### *Size I*

- 1 Right-click **Free Tetrahedral I** and choose **Size**.
- 2 In the **Settings** window for **Size**, locate the **Geometric Entity Selection** section.
- 3 From the **Geometric entity level** list, choose **Boundary**.
- 4 Select Boundaries 5–7 only.
- 5 Locate the **Element Size** section. From the **Predefined** list, choose **Extra fine**.



6 Click  **Build All**.

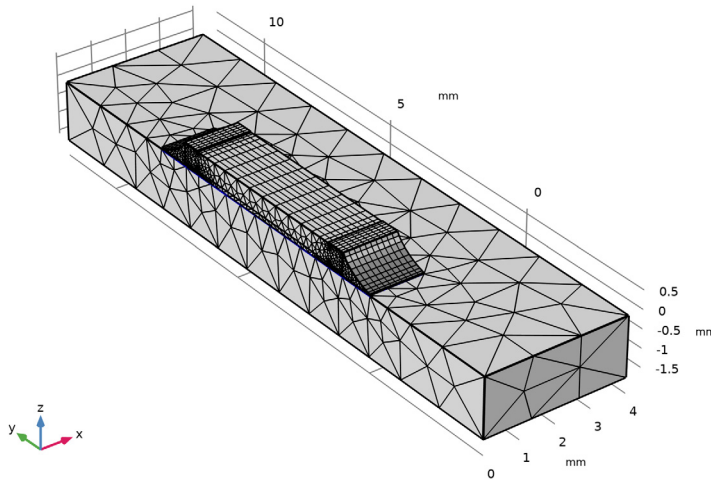



Because the heat transfer problem is independent of the displacements, use the first stationary study step to find the temperature distribution and the second stationary step to solve for the displacements.

## STUDY 1

### *Step 1: Stationary*

- 1 In the **Model Builder** window, under **Study 1** click **Step 1: Stationary**.
- 2 In the **Settings** window for **Stationary**, locate the **Physics and Variables Selection** section.
- 3 In the table, clear the **Solve for** check box for **Solid Mechanics (solid)**.

### *Stationary 2*

- 1 In the **Study** toolbar, click  **Study Steps** and choose **Stationary>Stationary**.
- 2 In the **Settings** window for **Stationary**, locate the **Physics and Variables Selection** section.
- 3 In the table, clear the **Solve for** check box for **Heat Transfer in Solids (ht)**.
- 4 In the **Study** toolbar, click  **Compute**.

## RESULTS

### *Volume 1*

- 1 In the **Model Builder** window, expand the **Stress (solid)** node, then click **Volume 1**.

**2** In the **Settings** window for **Volume**, locate the **Expression** section.

**3** From the **Unit** list, choose **MPa**.

Hold down the left mouse button and drag in the **Graphics** window to rotate the geometry so that you see the opposite side of the resistor, which is where the largest stresses occur, as shown in [Figure 4](#). Similarly, use the right mouse button to translate the geometry and the middle button to zoom.

Now, study the stresses in the solder.

#### *Stress in Solder Joint*

**1** In the **Home** toolbar, click  **Add Plot Group** and choose **3D Plot Group**.

**2** In the **Settings** window for **3D Plot Group**, type *Stress in Solder Joint* in the **Label** text field.

**3** Locate the **Plot Settings** section. Clear the **Plot dataset edges** check box.

#### *Volume 1*

**1** Right-click **Stress in Solder Joint** and choose **Volume**.

**2** In the **Settings** window for **Volume**, click **Replace Expression** in the upper-right corner of the **Expression** section. From the menu, choose **Component 1 (comp1)>Solid Mechanics>Stress>solid.mises - von Mises stress - N/m<sup>2</sup>**.

**3** Locate the **Expression** section. From the **Unit** list, choose **MPa**.

**4** Locate the **Coloring and Style** section. Click  **Change Color Table**.

**5** In the **Color Table** dialog box, select **Rainbow>Prism** in the tree.

**6** Click **OK**.

#### *Selection 1*

**1** Right-click **Volume 1** and choose **Selection**.

**2** Select Domain 8 only.

**3** In the **Stress in Solder Joint** toolbar, click  **Plot**.

**4** Click the  **Go to YZ View** button in the **Graphics** toolbar.

Compare the resulting plot with that in [Figure 5](#).

#### *Temperature (ht)*

The second default plot group shows the temperature on the modeled geometry's surface.

I Click the  **Go to Default View** button in the **Graphics** toolbar.

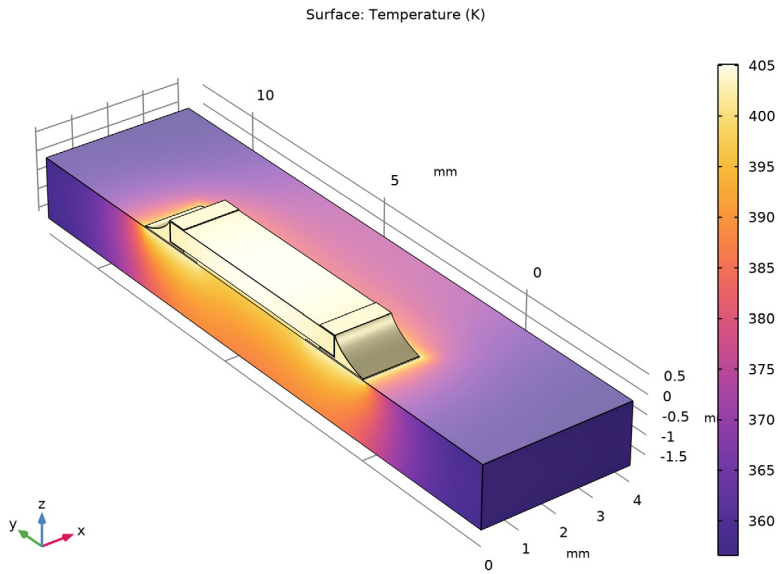

*Isothermal Contours (ht)*

The third default plot shows the isosurfaces ([Figure 3](#)).

