



Schmidt-Cassegrain Telescope

Introduction

The Cassegrain form of this telescope is an evolution of the camera designed by Bernhard Schmidt in 1929. The original Schmidt camera featured a thin aspheric plate placed at the center of curvature of the spherical primary mirror, which was able to eliminate spherical aberration. The Schmidt-Cassegrain telescope featured in this tutorial has a spherical secondary mirror that is intended to be mounted on the inside of the aspheric corrector plate. Although this results in some residual off-axis coma and focal plane curvature, the overall form is extremely compact. Telescopes based on this design are widely used in the amateur astronomical community.

The Schmidt-Cassegrain telescope demonstrated in this tutorial uses an aspheric corrector lens and two spherical mirrors. The aspheric corrector is created using the *Aspheric Even Lens 3D* part from the Ray Optics Module Part Library. The spherical parts use the *Spherical Mirror 3D* part. An overview of the telescope can be seen in [Figure 1](#).

Another closely related catadioptric telescope model, the [Gregory-Maksutov Telescope](#), can also be found in the COMSOL Ray Optics Module Application Library.

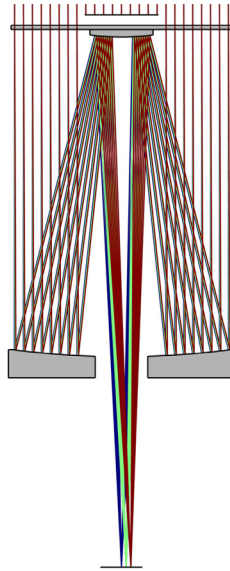

Figure 1: Overview of the Schmidt-Cassegrain telescope.

Model Definition

Details of the Schmidt-Cassegrain telescope used in this example can be found in [Ref. 1](#). The chosen design has a 203.2 mm diameter entrance pupil and an $f/10$ focal ratio. The nominal optical prescription is given in [Table 1](#).

TABLE 1: SCHMIDT-CASSEGRAIN TELESCOPE OPTICAL PRESCRIPTION.

Identity	Details	Material	Radius (mm)	Thickness (mm)	Diameter (mm)
Object		—	—	Infinity	0
1	Reference surface	—	—	50.0000	0
2	Central obstruction	—	—	10.0000	70.0
Stop	Corrector lens, entr.	N-BK7	—	4.0000	203.2000
4	Corrector lens, exit ^a	—	-56,118.2800	7.0000	203.2458
5	Secondary mirror ref.	—	—	303.8701	0
6	Primary mirror ^b	Mirror	-812.8000	-303.8701	206.1674
7	Secondary mirror	Mirror	-252.6581	303.8701	53.9204
8	Primary mirror ref.	—	—	200.0000	0
Image	Image surface	—	—	—	17.8789

a. Even asphere. Coefficients are: $A_4 = 6.431003e-10$, $A_6 = 3.11397e-16$. Units are mm.

b. Primary mirror central hole diameter: $d_{\text{hole}} = 50.0000$ mm.

The telescope geometry is constructed using parts from the Ray Optics Module Part Library. The Schmidt corrector is created using an instance of the *Aspheric Even Lens 3D* part, whereas the *Spherical Mirror 3D* part is used to create the primary and secondary mirrors. Note that the optical prescription has been reformatted to allow these parts to be defined in a somewhat arbitrary sequence; that is, the order in which optical elements are placed in a COMSOL geometry sequence does not affect the ray trace. However, the optical elements can be placed relative to one another by making use of built-in work-planes in each of the Part Instances.

The resulting Schmidt-Cassegrain telescope geometry sequence is shown in [Figure 2](#). Detailed instructions for creating the geometry can be found in [Appendix — Geometry Instructions](#).

The default Physics-controlled mesh should be slightly refined in order to reduce the effects of discretization. The mesh used in this simulation can be seen in [Figure 3](#).

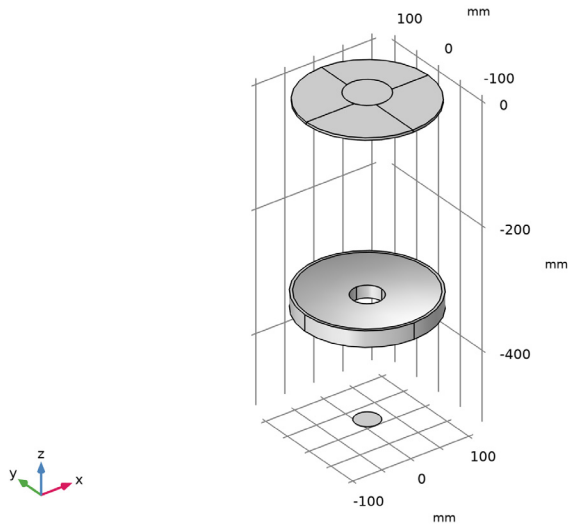

Figure 2: The Schmidt-Cassegrain telescope geometry sequence.

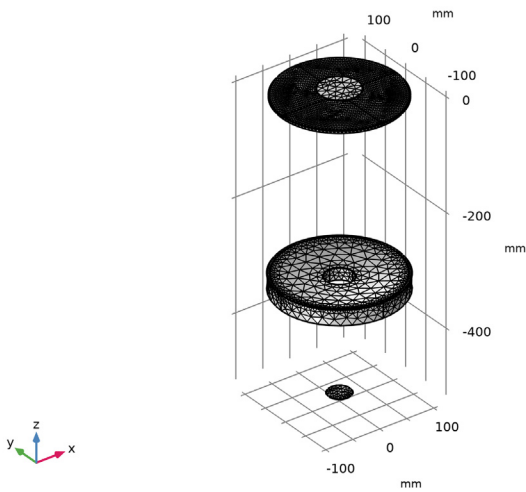

Figure 3: The Schmidt-Cassegrain telescope mesh.

Results and Discussion

A ray trace has been performed using three wavelengths (486 nm, 546 nm, and 656 nm) at three field angles (0, 0.125, and 0.25 degrees). Figure 4 shows the resulting ray trajectories; the **Color Expression** represents the ray positions on the image surface.

In Figure 5 the intersection of the rays with the image surface is shown. This spot diagram shows each of the three field angles, where the **Color Expression** is the wavelength.

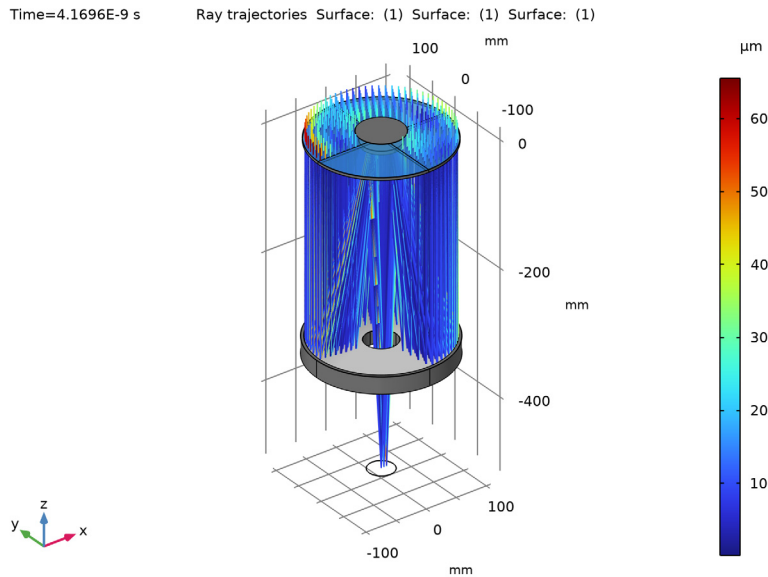

Figure 4: Ray diagram for the Schmidt-Cassegrain telescope colored by radial distance from the centroid.

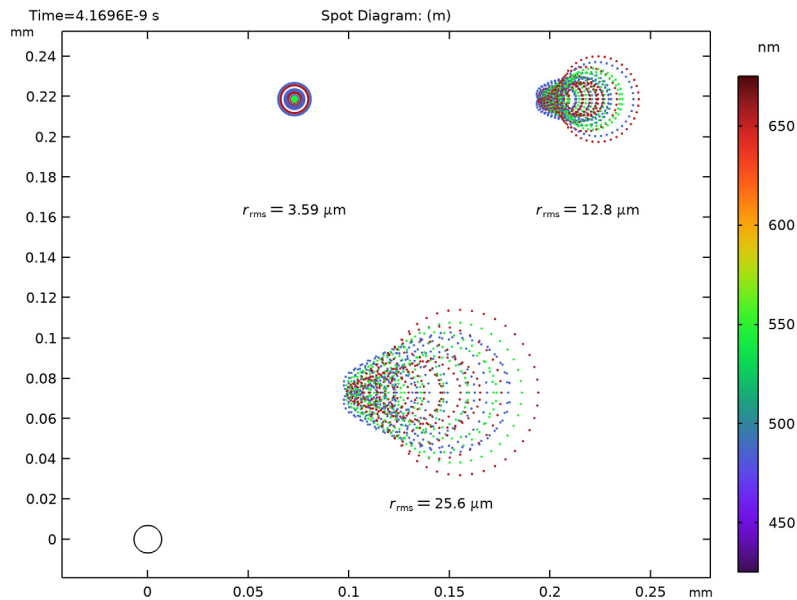

Figure 5: Spot diagram for the Schmidt-Cassegrain telescope colored by wavelength. The Airy disc is shown for reference in the lower-left corner.

References

1. G.H. Smith, R. Ceragioli, and R. Berry, *Telescopes, Eyepieces, and Astrographs: Design, Analysis, and Performance of Modern Astronomical Optics*, Willmann-Bell, 2012.

Application Library path: Ray_Optics_Module/Lenses_Cameras_and_Telescopes/
schmidt_cassegrain_telescope



Modeling Instructions

From the **File** menu, choose **New**.

NEW

In the **New** window, click  **Model Wizard**.

MODEL WIZARD

- 1 In the **Model Wizard** window, click  **3D**.
- 2 In the **Select Physics** tree, select **Optics>Ray Optics>Geometrical Optics (gop)**.
- 3 Click **Add**.
- 4 Click  **Study**.
- 5 In the **Select Study** tree, select **Preset Studies for Selected Physics Interfaces>Ray Tracing**.
- 6 Click  **Done**.



GLOBAL DEFINITIONS

Parameters 1: Lens Prescription

- 1 In the **Model Builder** window, under **Global Definitions** click **Parameters 1**.
- 2 In the **Settings** window for **Parameters**, type Parameters 1: Lens Prescription in the **Label** text field. The lens prescription will be added when the geometry sequence is inserted in the following section.

Parameters 2: General



The simulation parameters can be loaded from a text file.

- 1 In the **Home** toolbar, click  **Parameters** and choose **Add>Parameters**.
- 2 In the **Settings** window for **Parameters**, type Parameters 2: General in the **Label** text field.
- 3 Locate the **Parameters** section. Click  **Load from File**.
- 4 Browse to the model's Application Libraries folder and double-click the file schmidt_cassegrain_telescope_parameters.txt.



SCHMIDT-CASSEGRAIN TELESCOPE

Insert the prepared geometry sequence from file. You can read the instructions for creating the geometry in the appendix. Following insertion, the lens definitions will be available in the **Parameters** node.

- 1 In the **Model Builder** window, under **Component 1 (comp1)** click **Geometry 1**.
- 2 In the **Settings** window for **Geometry**, locate the **Units** section.
- 3 From the **Length unit** list, choose **mm**.
- 4 In the **Label** text field, type Schmidt-Cassegrain Telescope.
- 5 In the **Geometry** toolbar, click **Insert Sequence** and choose **Insert Sequence**.

- 6 Browse to the model's Application Libraries folder and double-click the file `schmidt_cassegrain_telescope_geom_sequence.mph`.
- 7 In the **Geometry** toolbar, click  **Build All**.
- 8 Click the  **Orthographic Projection** button in the **Graphics** toolbar. Compare the resulting geometry to [Figure 2](#).

ADD MATERIAL

- 1 In the **Home** toolbar, click  **Add Material** to open the **Add Material** window.
- 2 Go to the **Add Material** window.
- 3 In the tree, select **Optical>Schott Glass>Schott N-BK7 Glass**.
- 4 Click **Add to Component** in the window toolbar.
- 5 In the **Home** toolbar, click  **Add Material** to close the **Add Material** window.

MATERIALS

Schott N-BK7 Glass (mat1)

- 1 In the **Settings** window for **Material**, locate the **Geometric Entity Selection** section.
- 2 From the **Selection** list, choose **All (Corrector)**.

GEOMETRICAL OPTICS (GOP)

- 1 In the **Model Builder** window, under **Component 1 (comp1)** click **Geometrical Optics (gop)**.
- 2 Select Domain 2 only.
- 3 In the **Settings** window for **Geometrical Optics**, locate the **Ray Release and Propagation** section.
- 4 From the **Wavelength distribution of released rays** list, choose **Polychromatic, specify vacuum wavelength**.
- 5 In the **Maximum number of secondary rays** text field, type 0. In this simulation stray light is not being traced, so reflected rays will not be produced at the lens surfaces.

Medium Properties 1

- 1 In the **Model Builder** window, under **Component 1 (comp1)>Geometrical Optics (gop)** click **Medium Properties 1**.
- 2 In the **Settings** window for **Medium Properties**, locate the **Medium Properties** section.
- 3 From the **Refractive index of domains** list, choose **Get dispersion model from material**.
The material added above contains the optical dispersion coefficients which can be used to compute the refractive index as a function of wavelength.

Material Discontinuity 1

- 1 In the **Model Builder** window, click **Material Discontinuity 1**.
- 2 In the **Settings** window for **Material Discontinuity**, locate the **Rays to Release** section.
- 3 From the **Release reflected rays** list, choose **Never**.

Mirrors

- 1 In the **Physics** toolbar, click  **Boundaries** and choose **Mirror**.
- 2 In the **Settings** window for **Mirror**, type **Mirrors** in the **Label** text field.
- 3 Locate the **Boundary Selection** section. From the **Selection** list, choose **Mirrors**.

Obstructions

- 1 In the **Physics** toolbar, click  **Boundaries** and choose **Wall**.
- 2 In the **Settings** window for **Wall**, type **Obstructions** in the **Label** text field.
- 3 Locate the **Boundary Selection** section. From the **Selection** list, choose **Obstructions**.
- 4 Locate the **Wall Condition** section. From the **Wall condition** list, choose **Disappear**.

Image

- 1 In the **Physics** toolbar, click  **Boundaries** and choose **Wall**.
- 2 In the **Settings** window for **Wall**, type **Image** in the **Label** text field.
- 3 Locate the **Boundary Selection** section. From the **Selection** list, choose **All (Image plane)**.

Release from Grid 1

Release rays from a set of hexapolar grids using quantities defined in the **Parameters 2: General** node.

- 1 In the **Physics** toolbar, click  **Global** and choose **Release from Grid**.
- 2 In the **Settings** window for **Release from Grid**, locate the **Initial Coordinates** section.
- 3 From the **Grid type** list, choose **Hexapolar**.
- 4 Specify the \mathbf{q}_c vector as

dx1	x
dy1	y
dz	z

- 5 Specify the \mathbf{r}_c vector as

0	x
---	---

0	y
1	z

6 In the R_c text field, type $P_{nom}/2$.

7 In the N_c text field, type N_{ring} .

8 Locate the **Ray Direction Vector** section. Specify the L_0 vector as

vx1	x
vy1	y
vz	z

9 Locate the **Vacuum Wavelength** section. From the **Distribution function** list, choose **List of values**.

10 In the **Values** text field, type $1\lambda_1 \ 1\lambda_2 \ 1\lambda_3$. These wavelengths were defined in the **Parameters 2: General** node.

Release from Grid 2

1 Right-click **Release from Grid 1** and choose **Duplicate**.

2 In the **Settings** window for **Release from Grid**, locate the **Initial Coordinates** section.

3 Specify the q_c vector as

dx2	x
dy2	y

4 Locate the **Ray Direction Vector** section. Specify the L_0 vector as

vx2	x
vy2	y

Release from Grid 3

1 Right-click **Release from Grid 2** and choose **Duplicate**.

2 In the **Settings** window for **Release from Grid**, locate the **Initial Coordinates** section.

3 Specify the q_c vector as

dx3	x
dy3	y

4 Locate the **Ray Direction Vector** section. Specify the \mathbf{L}_0 vector as

v_{x3}	x
v_{y3}	y

MESH I

- 1 In the **Model Builder** window, under **Component 1 (comp1)** click **Mesh 1**.
- 2 In the **Settings** window for **Mesh**, locate the **Physics-Controlled Mesh** section.
- 3 From the **Element size** list, choose **Finer**. Slightly refine the mesh to improve the ray tracing accuracy.
- 4 Click  **Build All**. The mesh should look like [Figure 3](#).

STUDY I

Step 1: Ray Tracing

- 1 In the **Model Builder** window, under **Study 1** click **Step 1: Ray Tracing**.
- 2 In the **Settings** window for **Ray Tracing**, locate the **Study Settings** section.
- 3 From the **Time-step specification** list, choose **Specify maximum path length**.
- 4 From the **Length unit** list, choose **mm**.
- 5 In the **Lengths** text field, type 0 1250.
- 6 In the **Home** toolbar, click  **Compute**.

RESULTS

Ray Diagram

Now, make some modifications to the default Ray Trajectories plot.

- 1 In the **Settings** window for **3D Plot Group**, type Ray Diagram in the **Label** text field.
- 2 Locate the **Color Legend** section. Select the **Show units** check box.

Ray Trajectories 1

In the **Model Builder** window, expand the **Ray Diagram** node.

Color Expression 1

- 1 In the **Model Builder** window, expand the **Ray Trajectories 1** node, then click **Color Expression 1**.
- 2 In the **Settings** window for **Color Expression**, locate the **Expression** section.

- 3 In the **Expression** text field, type at ('last',gop.rrel). This expression gives the radial distance from the centroid of the spot on the image plane generated by each release feature.
- 4 From the **Unit** list, choose **µm**.

Filter 1

- 1 In the **Model Builder** window, click **Filter 1**.
- 2 In the **Settings** window for **Filter**, locate the **Ray Selection** section.
- 3 From the **Rays to include** list, choose **Logical expression**.
- 4 In the **Logical expression for inclusion** text field, type at $(0, \text{atan2}(qy, qx) > -\pi/2)$. This filter removes 1/4 of the rays so that the optical geometry is visible.

Ray Diagram

In the following we add and color surface plots to show the various telescope optical elements.

Surface 1

- 1 In the **Model Builder** window, right-click **Ray Diagram** and choose **Surface**.
- 2 In the **Settings** window for **Surface**, locate the **Coloring and Style** section.
- 3 From the **Coloring** list, choose **Uniform**.
- 4 From the **Color** list, choose **Gray**.

Selection 1

- 1 Right-click **Surface 1** and choose **Selection**.
- 2 In the **Settings** window for **Selection**, locate the **Selection** section.
- 3 From the **Selection** list, choose **Mirrors**.

Surface 2

In the **Model Builder** window, under **Results>Ray Diagram** right-click **Surface 1** and choose **Duplicate**.

Selection 1

- 1 In the **Model Builder** window, expand the **Surface 2** node, then click **Selection 1**.
- 2 In the **Settings** window for **Selection**, locate the **Selection** section.
- 3 From the **Selection** list, choose **Obstructions**.

Surface 2

- 1 In the **Model Builder** window, click **Surface 2**.
- 2 In the **Settings** window for **Surface**, locate the **Coloring and Style** section.

- 3 From the **Color** list, choose **Custom**.
- 4 On Windows, click the colored bar underneath, or — if you are running the cross-platform desktop — the **Color** button.
- 5 Click **Define custom colors**.
- 6 Set the RGB values to 105, 105, and 105, respectively.
- 7 Click **Add to custom colors**.
- 8 Click **Show color palette only** or **OK** on the cross-platform desktop.

Surface 3

Right-click **Results>Ray Diagram>Surface 2** and choose **Duplicate**.



Selection 1

- 1 In the **Model Builder** window, expand the **Surface 3** node, then click **Selection 1**.
- 2 In the **Settings** window for **Selection**, locate the **Selection** section.
- 3 From the **Selection** list, choose **Clear Apertures**.

Surface 3

- 1 In the **Model Builder** window, click **Surface 3**.
- 2 In the **Settings** window for **Surface**, locate the **Coloring and Style** section.
- 3 Click **Define custom colors**.
- 4 Set the RGB values to 54, 140, and 203, respectively.
- 5 Click **Add to custom colors**.
- 6 Click **Show color palette only** or **OK** on the cross-platform desktop.

Transparency 1

- 1 Right-click **Surface 3** and choose **Transparency**.
- 2 In the **Ray Diagram** toolbar, click  **Plot**.
- 3 Click the  **Zoom Extents** button in the **Graphics** toolbar. Compare the resulting image to [Figure 4](#).

Spot Diagram



- 1 In the **Home** toolbar, click  **Add Plot Group** and choose **2D Plot Group**.
- 2 In the **Settings** window for **2D Plot Group**, type Spot Diagram in the **Label** text field.
- 3 Locate the **Color Legend** section. Select the **Show units** check box.

Spot Diagram 1

- 1 In the **Spot Diagram** toolbar, click  **More Plots** and choose **Spot Diagram**.

- 2 In the **Settings** window for **Spot Diagram**, locate the **Layout** section.
- 3 From the **Origin location** list, choose **Average over area**. This option centers each spot on the midpoint of all rays.
- 4 Click to expand the **Annotations** section. Select the **Show circle** check box.
- 5 In the **Radius** text field, type `r_Airy`.

Color Expression I

- 1 Right-click **Spot Diagram I** and choose **Color Expression**.
- 2 In the **Settings** window for **Color Expression**, locate the **Expression** section.
- 3 In the **Expression** text field, type `gop.lamda0`.
- 4 From the **Unit** list, choose **nm**.
- 5 Click to expand the **Range** section. Select the **Manual color range** check box.
- 6 In the **Minimum** text field, type 425.
- 7 In the **Maximum** text field, type 675.
- 8 Locate the **Coloring and Style** section. Click  **Change Color Table**.
- 9 In the **Color Table** dialog box, select **Rainbow>Spectrum** in the tree.
- 10 Click **OK**.
- 11 In the **Spot Diagram** toolbar, click  **Plot**.
- 12 Click the  **Zoom Extents** button in the **Graphics** toolbar. Compare the resulting image to [Figure 5](#).



Appendix — Geometry Instructions

From the **File** menu, choose **New**.

NEW

In the **New** window, click  **Model Wizard**.

MODEL WIZARD

- 1 In the **Model Wizard** window, click  **3D**.
- 2 Click  **Done**.

SCHMIDT-CASSEGRAIN TELESCOPE GEOMETRY SEQUENCE

- 1 In the **Model Builder** window, under **Component 1 (comp1)** click **Geometry 1**.
- 2 In the **Settings** window for **Geometry**, type Schmidt-Cassegrain Telescope Geometry Sequence in the **Label** text field.

- 3 Locate the **Units** section. From the **Length unit** list, choose **mm**.



GLOBAL DEFINITIONS

Parameters 1

- 1 In the **Model Builder** window, under **Global Definitions** click **Parameters 1**.
- 2 In the **Settings** window for **Parameters**, locate the **Parameters** section.
- 3 Click  **Load from File**.
- 4 Browse to the model's Application Libraries folder and double-click the file `schmidt_cassegrain_telescope_geom_sequence_parameters.txt`. This file contains details of the telescope optical prescription.

We now insert parts from the Ray Optics Parts Libraries which can be used to create each of the telescope optical elements. Begin by inserting the corrector lens.

PART LIBRARIES

- 1 In the **Home** toolbar, click  **Windows** and choose **Part Libraries**.
- 2 In the **Model Builder** window, under **Component 1 (comp1)** click **Schmidt-Cassegrain Telescope Geometry Sequence**.
- 3 In the **Part Libraries** window, select **Ray Optics Module>3D>Aspheric Lenses>aspheric_even_lens_3d** in the tree.
- 4 Click  **Add to Geometry**.
- 5 In the **Select Part Variant** dialog box, select **Specify clear aperture diameter** in the **Select part variant** list.
- 6 Click **OK**.

SCHMIDT-CASSEGRAIN TELESCOPE GEOMETRY SEQUENCE

Corrector

- 1 In the **Model Builder** window, under **Component 1 (comp1)>Schmidt-Cassegrain Telescope Geometry Sequence** click **Aspheric Even Lens 3D 1 (pi1)**.
- 2 In the **Settings** window for **Part Instance**, type **Corrector** in the **Label** text field.



3 Locate the **Input Parameters** section. In the table, enter the following settings:

Name	Expression	Value	Description
R1	R1_corr	0 m	Radius of curvature, surface 1 (+convex/-concave)
R2	R2_corr	-56118 mm	Radius of curvature, surface 2 (-convex/+concave)
k1	0	0	Conic constant, surface 1
k2	0	0	Conic constant, surface 2
A_norm	1 [mm]	1 mm	Aspheric normalization unit
A02_1	0	0	2nd order aspheric term, surface 1
A04_1	0	0	4th order aspheric term, surface 1
A06_1	0	0	6th order aspheric term, surface 1
A08_1	0	0	8th order aspheric term, surface 1
A10_1	0	0	10th order aspheric term, surface 1
A12_1	0	0	12th order aspheric term, surface 1
A14_1	0	0	14th order aspheric term, surface 1
A16_1	0	0	16th order aspheric term, surface 1
A18_1	0	0	18th order aspheric term, surface 1
A20_1	0	0	20th order aspheric term, surface 1
A22_1	0	0	22nd order aspheric term, surface 1
A02_2	0	0	2nd order aspheric term, surface 2
A04_2	A04_corr	6.431E-10	4th order aspheric term, surface 2
A06_2	A06_corr	3.114E-16	6th order aspheric term, surface 2
A08_2	0	0	8th order aspheric term, surface 2
A10_2	0	0	10th order aspheric term, surface 2
A12_2	0	0	12th order aspheric term, surface 2
A14_2	0	0	14th order aspheric term, surface 2
A16_2	0	0	16th order aspheric term, surface 2
A18_2	0	0	18th order aspheric term, surface 2
A20_2	0	0	20th order aspheric term, surface 2
A22_2	0	0	22nd order aspheric term, surface 2
Tc	Tc_corr	4 mm	Center thickness
d0	d0_corr	210 mm	Lens full diameter

Name	Expression	Value	Description
d1	0	0 m	Diameter, surface 1
d2	0	0 m	Diameter, surface 2
d1_clear	0	0 m	Clear aperture diameter, surface 1
d2_clear	0	0 m	Clear aperture diameter, surface 2
nix	nix	0	Local optical axis, x-component
niy	niy	0	Local optical axis, y-component
niz	niz	-1	Local optical axis, z-component

Next, create the primary and secondary mirrors.

PART LIBRARIES

- 1 In the **Home** toolbar, click  **Windows** and choose **Part Libraries**.
- 2 In the **Model Builder** window, click **Schmidt-Cassegrain Telescope Geometry Sequence**.
- 3 In the **Part Libraries** window, select **Ray Optics Module>3D>Mirrors>spherical_mirror_3d** in the tree.
- 4 Click  **Add to Geometry**.
- 5 In the **Select Part Variant** dialog box, select **Specify clear aperture diameter** in the **Select part variant** list.
- 6 Click **OK**.

SCHMIDT-CASSEGRAIN TELESCOPE GEOMETRY SEQUENCE

Secondary mirror

- 1 In the **Model Builder** window, under **Component 1 (comp1)>Schmidt-Cassegrain Telescope Geometry Sequence** click **Spherical Mirror 3D 1 (pi2)**.
- 2 In the **Settings** window for **Part Instance**, type **Secondary mirror** in the **Label** text field.
- 3 Locate the **Input Parameters** section. In the table, enter the following settings:

Name	Expression	Value	Description
R	R_sec	252.66 mm	Radius of curvature (+convex/-concave)
Tc	Tc_sec	7 mm	Center thickness
d0	d0_sec	60 mm	Mirror full diameter
d1	0	0 m	Mirror surface diameter
d_clear	0	0 m	Clear aperture diameter

Name	Expression	Value	Description
d_hole	0	0 m	Center hole diameter
niz	-1	-1	Local optical axis, z-component

- 4 Locate the **Position and Orientation of Output** section. Find the **Coordinate system to match** subsection. From the **Take work plane from** list, choose **Corrector (pi1)**.
- 5 From the **Work plane** list, choose **Surface 2 vertex intersection (wp2)**.
- 6 Find the **Displacement** subsection. In the **zw** text field, type **z_sec**.

Primary mirror

- 1 In the **Geometry** toolbar, click  **Parts** and choose **Spherical Mirror 3D**.
- 2 In the **Settings** window for **Part Instance**, type **Primary mirror** in the **Label** text field.
- 3 Locate the **Input Parameters** section. In the table, enter the following settings:

Name	Expression	Value	Description
R	R_prim	-812.8 mm	Radius of curvature (+convex/-concave)
Tc	Tc_prim	20 mm	Center thickness
d0	d0_prim	215 mm	Mirror full diameter
d1	d1_prim	206.17 mm	Mirror surface diameter
d_clear	0	0 m	Clear aperture diameter
d_hole	dh_prim	50 mm	Center hole diameter
niz	-1	-1	Local optical axis, z-component

- 4 Locate the **Position and Orientation of Output** section. Find the **Coordinate system to match** subsection. From the **Take work plane from** list, choose **Secondary mirror (pi2)**.
- 5 From the **Work plane** list, choose **Mirror vertex intersection (wp1)**.
- 6 Find the **Displacement** subsection. In the **zw** text field, type **z_prim**.

Finally, create the image plane and central obstruction.

PART LIBRARIES

- 1 In the **Geometry** toolbar, click  **Parts** and choose **Part Libraries**.
- 2 In the **Model Builder** window, click **Schmidt-Cassegrain Telescope Geometry Sequence**.

3 In the **Part Libraries** window, select **Ray Optics Module>3D>Apertures and Obstructions>circular_planar_annulus** in the tree.

4 Click  **Add to Geometry**.

SCHMIDT-CASSEGRAIN TELESCOPE GEOMETRY SEQUENCE

Image plane

1 In the **Model Builder** window, under **Component 1 (comp1)>Schmidt-**

Cassegrain Telescope Geometry Sequence click **Circular Planar Annulus 1 (pi4)**.

2 In the **Settings** window for **Part Instance**, type **Image plane** in the **Label** text field.

3 Locate the **Input Parameters** section. In the table, enter the following settings:

Name	Expression	Value	Description
d0	d_img	40 mm	Diameter, outer
d1	0	0 m	Diameter, inner

4 Locate the **Position and Orientation of Output** section. Find the **Coordinate system to match** subsection. From the **Take work plane from** list, choose **Primary mirror (pi3)**.

5 From the **Work plane** list, choose **Mirror vertex intersection (wp1)**.

6 Find the **Displacement** subsection. In the **zw** text field, type **z_img**.

Central obstruction

1 In the **Geometry** toolbar, click  **Parts** and choose **Circular Planar Annulus**.

2 In the **Settings** window for **Part Instance**, type **Central obstruction** in the **Label** text field.

3 Locate the **Input Parameters** section. In the table, enter the following settings:

Name	Expression	Value	Description
d0	d_obs	70 mm	Diameter, outer
d1	0	0 m	Diameter, inner

4 Locate the **Position and Orientation of Output** section. Find the **Coordinate system to match** subsection. From the **Take work plane from** list, choose **Corrector (pi1)**.

5 From the **Work plane** list, choose **Surface 1 vertex intersection (wp1)**.

6 Find the **Displacement** subsection. In the **zw** text field, type **z_obs**.

7 Click  **Build All Objects**.

8 Click the  **Orthographic Projection** button in the **Graphics** toolbar.

9 Click the  **Zoom Extents** button in the **Graphics** toolbar.

In the following sections we create selections that can be used to define the physics and during postprocessing.

Corrector (pi1)

- 1 In the **Model Builder** window, click **Corrector (pi1)**.
- 2 In the **Settings** window for **Part Instance**, click to expand the **Domain Selections** section.
- 3 In the table, select the **Keep** check box for **All**.
- 4 Click to expand the **Boundary Selections** section. Click to select row number 2 in the table.
- 5 Click **New Cumulative Selection**.
- 6 In the **New Cumulative Selection** dialog box, type Clear Apertures in the **Name** text field.
- 7 Click **OK**.
- 8 In the **Settings** window for **Part Instance**, locate the **Boundary Selections** section.
- 9 In the table, enter the following settings:

Name	Keep	Physics	Contribute to
Surface 1		√	Clear Apertures
Surface 2		√	Clear Apertures

- 10 Click to select row number 4 in the table.
- 11 Click **New Cumulative Selection**.
- 12 In the **New Cumulative Selection** dialog box, type Obstructions in the **Name** text field.
- 13 Click **OK**.
- 14 In the **Settings** window for **Part Instance**, locate the **Boundary Selections** section.
- 15 In the table, enter the following settings:

Name	Keep	Physics	Contribute to
Surface 1 obstruction		√	Obstructions
Surface 2 obstruction		√	Obstructions
Edges		√	Obstructions

Secondary mirror (pi2)

- 1 In the **Model Builder** window, click **Secondary mirror (pi2)**.

- 2 In the **Settings** window for **Part Instance**, locate the **Boundary Selections** section.
- 3 Click to select row number 2 in the table.
- 4 Click **New Cumulative Selection**.
- 5 In the **New Cumulative Selection** dialog box, type **Mirrors** in the **Name** text field.
- 6 Click **OK**.
- 7 In the **Settings** window for **Part Instance**, locate the **Boundary Selections** section.
- 8 In the table, enter the following settings:

Name	Keep	Physics	Contribute to
Mirror surface		√	Mirrors
Mirror rear surface		√	Obstructions
Mirror edges		√	Obstructions

Primary mirror (pi3)

- 1 In the **Model Builder** window, click **Primary mirror (pi3)**.
- 2 In the **Settings** window for **Part Instance**, locate the **Boundary Selections** section.
- 3 In the table, enter the following settings:

Name	Keep	Physics	Contribute to
Mirror surface		√	Mirrors
Mirror rear surface		√	Obstructions
Mirror edges		√	Obstructions

Image plane (pi4)

- 1 In the **Model Builder** window, click **Image plane (pi4)**.
- 2 In the **Settings** window for **Part Instance**, locate the **Boundary Selections** section.
- 3 In the table, select the **Keep** check box for **All**.

Central obstruction (pi5)

- 1 In the **Model Builder** window, click **Central obstruction (pi5)**.
- 2 In the **Settings** window for **Part Instance**, locate the **Boundary Selections** section.
- 3 In the table, enter the following settings:

Name	Keep	Physics	Contribute to
All		√	Obstructions

