



# Gregory-Maksutov Telescope

## *Introduction*

---

The Gregory-Maksutov telescope is a simple catadioptric telescope comprising a spherical corrector lens and a spherical primary mirror. In this example, the corrector lens and mirror are formed using the ‘Spherical Lens 3D’ and ‘Spherical Mirror 3D’ parts, respectively, from the Ray Optics Module Part Library. A cross-section of the optical design is shown in [Figure 1](#).

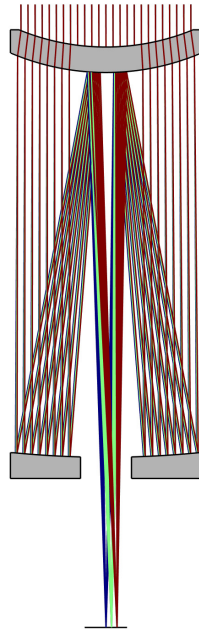

*Figure 1: Overview of the Gregory-Maksutov telescope.*

The origin of the Gregory-Maksutov telescope was a desire to avoid the aspheric corrector used in the Schmidt family of telescopes. An example of this type of telescope, the [Schmidt-Cassegrain Telescope](#), can also be found in the Ray Optics Module Application Library. At least four optical designers, including Dmitri Maksutov, found a solution involving a meniscus corrector lens in the early 1940s, and it was John Gregory who, in 1957, popularized the design used in this tutorial.

## Model Definition

Details of the Gregory-Maksutov telescope used in this tutorial can be found in [Ref. 1](#). This telescope has a 200 mm entrance aperture and an  $f/15$  focal ratio. The detailed optical prescription is given in [Table 1](#).

TABLE 1: GREGORY-MAKSUTOV TELESCOPE OPTICAL PRESCRIPTION.

Details	Material	Radius (mm)	Thickness (mm)	Diameter (mm)	
Object	—	—	Infinity	0	
1	Reference surface	—	75.0000	0	
2	Central obstruction	—	20.0000	70.0000	
Stop	Corrector, surface 1	N-BK7	-268.6151	30.0000	200.1688
4	Corrector, surface 2	—	-286.1193	453.0476	208.0594
5	Primary mirror <sup>a</sup>	Mirror	-1111.6100	-453.0476	217.0732
6	Secondary mirror <sup>b</sup>	Mirror	-286.1193	453.0476	48.2704
7	Primary mirror vertex	—	—	200.0000	0
Image	Image surface	—	—	—	26.0556

a. The primary mirror central hole diameter is  $d = 60.0$  mm.

b. The secondary mirror surface is on surface 2 of the corrector.

The telescope geometry is constructed using parts from the Ray Optics Module Part Library. The meniscus corrector is created using an instance of the Spherical Lens 3D part, whereas the Spherical Mirror 3D part is used to create the primary mirror. The secondary mirror is defined by an aperture on surface 2 of the meniscus corrector. That is, the surface is intended to be reflective within this aperture. Other predefined selections on this part are used to define the corrector clear apertures as well as the central obstruction.

When constructing a geometry in COMSOL to be used in a Geometrical Optics ray trace, it is important to appreciate that the order in which optical elements are placed in a geometry sequence does not affect the results of the trace. However, it is convenient to place optical elements relative to one another. This can be achieved by taking one of the built-in work planes in a Part Instance as the reference for the placement of the next Part Instance. The resulting Gregory-Maksutov telescope geometry sequence is shown in [Figure 2](#). Detailed instructions for creating the geometry can be found in [Appendix — Geometry Instructions](#).

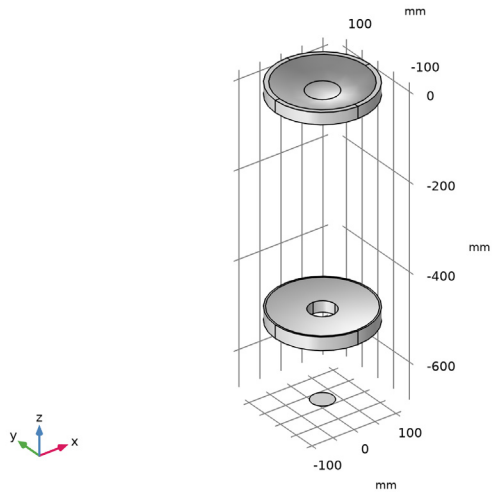

Figure 2: The Gregory-Maksutov telescope geometry sequence.

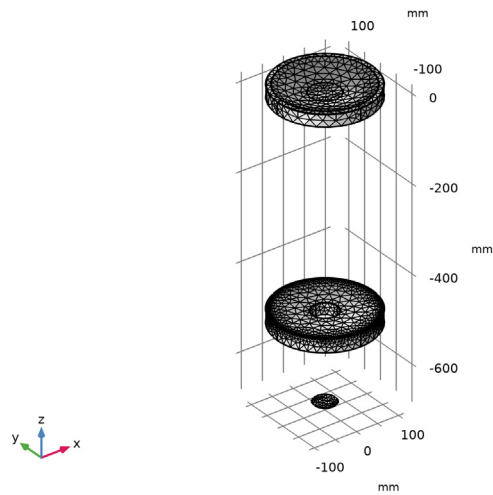

Figure 3: The mesh for the Gregory-Maksutov telescope. Note that the default Physics-based mesh should be slightly refined in order to improve the ray tracing accuracy.

## Results and Discussion

A ray trace has been performed using three wavelengths (486 nm, 546 nm, and 656 nm) at three field angles (0, 0.125, and 0.25 degrees). Figure 4 shows the resulting ray trajectories; the **Color Expression** represents the ray positions on the image surface.

In Figure 5, the intersection of the rays with the image surface is shown. This spot diagram shows each of the three field angles, where the **Color Expression** is the wavelength.

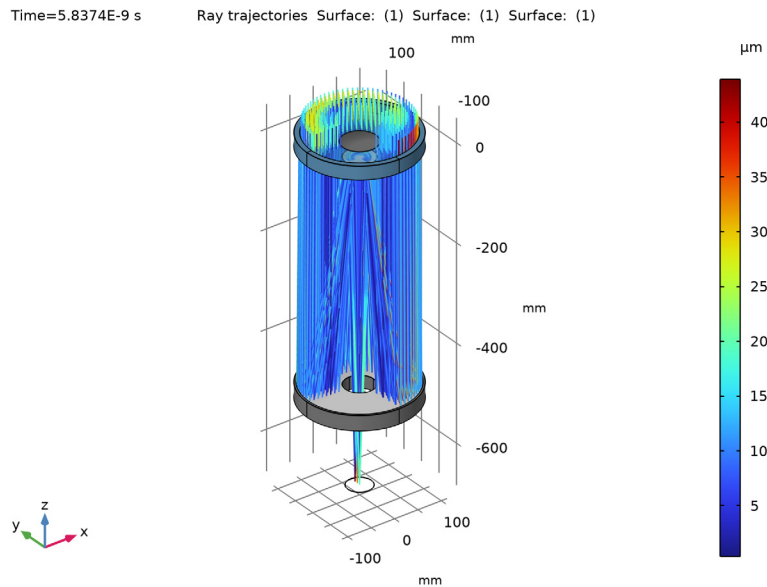

Figure 4: Ray diagram for the Gregory-Maksutov telescope colored by radial distance from the centroid.

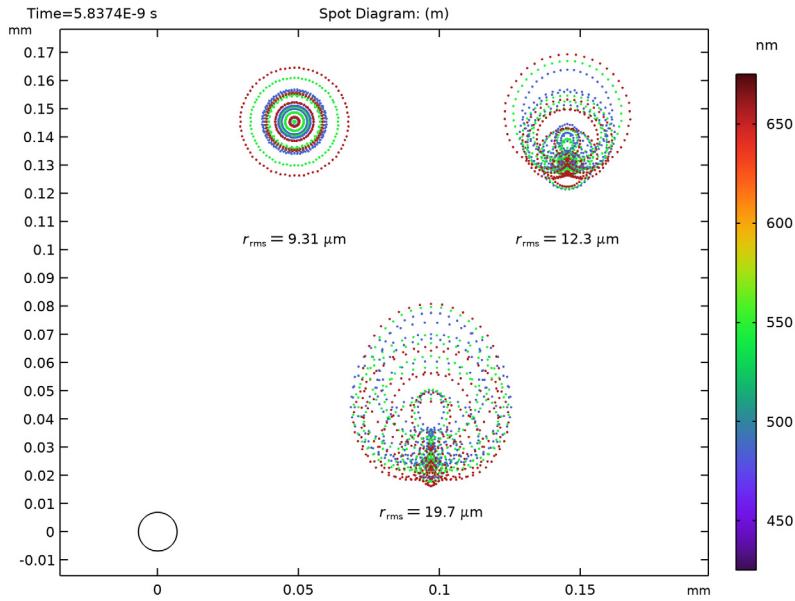

Figure 5: Spot diagram for the Gregory-Maksutov telescope colored by wavelength. For reference, the Airy disc is shown in the lower-left corner.

## Reference

1. G.H. Smith, R. Ceragioli, and R. Berry, *Telescopes, Eyepieces, and Astrographs: Design, Analysis, and Performance of Modern Astronomical Optics*, Willmann-Bell, 2012.

**Application Library path:** Ray\_Optics\_Module/Lenses\_Cameras\_and\_Telescopes/  
gregory\_maksutov\_telescope

## Modeling Instructions



---

From the **File** menu, choose **New**.

### NEW

In the **New** window, click  **Model Wizard**.

### MODEL WIZARD

- 1 In the **Model Wizard** window, click  **3D**.
- 2 In the **Select Physics** tree, select **Optics>Ray Optics>Geometrical Optics (gop)**.
- 3 Click **Add**.
- 4 Click  **Study**.
- 5 In the **Select Study** tree, select **Preset Studies for Selected Physics Interfaces>Ray Tracing**.
- 6 Click  **Done**.



### GLOBAL DEFINITIONS

#### *Parameters 1: Lens Prescription*

- 1 In the **Model Builder** window, under **Global Definitions** click **Parameters 1**.
- 2 In the **Settings** window for **Parameters**, type Parameters 1: Lens Prescription in the **Label** text field. The lens prescription will be added when the geometry sequence is inserted in the following section.

#### *Parameters 2: General*



The simulation parameters can be loaded from a text file.

- 1 In the **Home** toolbar, click  **Parameters** and choose **Add>Parameters**.
- 2 In the **Settings** window for **Parameters**, type Parameters 2: General in the **Label** text field.
- 3 Locate the **Parameters** section. Click  **Load from File**.
- 4 Browse to the model's Application Libraries folder and double-click the file `gregory_maksutov_telescope_parameters.txt`.



### GREGORY-MAKSUTOV TELESCOPE

Insert the prepared geometry sequence from file. You can read the instructions for creating the geometry in the appendix. Following insertion, the lens definitions will be available in the **Parameters** node.

- 1 In the **Model Builder** window, under **Component 1 (comp1)** click **Geometry 1**.

- 2 In the **Settings** window for **Geometry**, locate the **Units** section.
- 3 From the **Length unit** list, choose **mm**.
- 4 In the **Label** text field, type Gregory-Maksutov Telescope.
- 5 In the **Geometry** toolbar, click **Insert Sequence** and choose **Insert Sequence**.
- 6 Browse to the model's Application Libraries folder and double-click the file `gregory_maksutov_telescope_geom_sequence.mph`.
- 7 In the **Geometry** toolbar, click  **Build All**.
- 8 Click the  **Orthographic Projection** button in the **Graphics** toolbar. Compare the resulting geometry to [Figure 2](#).

#### ADD MATERIAL

- 1 In the **Home** toolbar, click  **Add Material** to open the **Add Material** window.
- 2 Go to the **Add Material** window.
- 3 In the tree, select **Optical>Schott Glass>Schott N-BK7 Glass**.
- 4 Click **Add to Component** in the window toolbar.
- 5 In the **Home** toolbar, click  **Add Material** to close the **Add Material** window.

#### MATERIALS

##### *Schott N-BK7 Glass (mat1)*

- 1 In the **Settings** window for **Material**, locate the **Geometric Entity Selection** section.
- 2 From the **Selection** list, choose **All (Corrector)**.

#### GEOMETRICAL OPTICS (GOP)

- 1 In the **Model Builder** window, under **Component 1 (comp1)** click **Geometrical Optics (gop)**.
- 2 Select Domain 2 only.
- 3 In the **Settings** window for **Geometrical Optics**, locate the **Ray Release and Propagation** section.
- 4 From the **Wavelength distribution of released rays** list, choose **Polychromatic, specify vacuum wavelength**.
- 5 In the **Maximum number of secondary rays** text field, type 0. In this simulation stray light is not being traced, so reflected rays will not be produced at the lens surfaces.

##### *Medium Properties 1*

- 1 In the **Model Builder** window, under **Component 1 (comp1)>Geometrical Optics (gop)** click **Medium Properties 1**.



- 2 In the **Settings** window for **Medium Properties**, locate the **Medium Properties** section.
- 3 From the **Refractive index of domains** list, choose **Get dispersion model from material**.  
The material added above contains the optical dispersion coefficients which can be used to compute the refractive index as a function of wavelength.

#### *Material Discontinuity I*

- 1 In the **Model Builder** window, click **Material Discontinuity I**.
- 2 In the **Settings** window for **Material Discontinuity**, locate the **Rays to Release** section.
- 3 From the **Release reflected rays** list, choose **Never**.

#### *Mirrors*

- 1 In the **Physics** toolbar, click  **Boundaries** and choose **Mirror**.
- 2 In the **Settings** window for **Mirror**, type Mirrors in the **Label** text field.
- 3 Locate the **Boundary Selection** section. From the **Selection** list, choose **Mirrors**.

#### *Obstructions*

- 1 In the **Physics** toolbar, click  **Boundaries** and choose **Wall**.
- 2 In the **Settings** window for **Wall**, type Obstructions in the **Label** text field.
- 3 Locate the **Boundary Selection** section. From the **Selection** list, choose **Obstructions**.
- 4 Locate the **Wall Condition** section. From the **Wall condition** list, choose **Disappear**.

#### *Image*

- 1 In the **Physics** toolbar, click  **Boundaries** and choose **Wall**.
- 2 In the **Settings** window for **Wall**, type Image in the **Label** text field.
- 3 Locate the **Boundary Selection** section. From the **Selection** list, choose **All (Image plane)**.

#### *Release from Grid I*

Release rays from a set of hexapolar grids using quantities defined in the **Parameters 2: General** node.

- 1 In the **Physics** toolbar, click  **Global** and choose **Release from Grid**.
- 2 In the **Settings** window for **Release from Grid**, locate the **Initial Coordinates** section.
- 3 From the **Grid type** list, choose **Hexapolar**.
- 4 Specify the  $\mathbf{q}_c$  vector as

dx1	x
dy1	y
dz	z

5 Specify the  $\mathbf{r}_c$  vector as

0	x
0	y
1	z

6 In the  $R_c$  text field, type P\_nom/2.

7 In the  $N_c$  text field, type N\_ring.

8 Locate the **Ray Direction Vector** section. Specify the  $\mathbf{L}_0$  vector as

vx1	x
vy1	y
vz	z

9 Locate the **Vacuum Wavelength** section. From the **Distribution function** list, choose **List of values**.

10 In the **Values** text field, type 1 $\lambda$ 1 1 $\lambda$ 2 1 $\lambda$ 3. These wavelengths were defined in the **Parameters 2: General** node.

*Release from Grid 2*

1 Right-click **Release from Grid 1** and choose **Duplicate**.

2 In the **Settings** window for **Release from Grid**, locate the **Initial Coordinates** section.

3 Specify the  $\mathbf{q}_c$  vector as

dx2	x
dy2	y

4 Locate the **Ray Direction Vector** section. Specify the  $\mathbf{L}_0$  vector as

vx2	x
vy2	y

*Release from Grid 3*

1 Right-click **Release from Grid 2** and choose **Duplicate**.

2 In the **Settings** window for **Release from Grid**, locate the **Initial Coordinates** section.

3 Specify the  $\mathbf{q}_c$  vector as

dx3	x
dy3	y

4 Locate the **Ray Direction Vector** section. Specify the  $\mathbf{L}_0$  vector as

$v_{x3}$	x
$v_{y3}$	y

### MESH I

Next, build the mesh. First, slightly refine the mesh to improve the ray tracing accuracy.

- 1 In the **Model Builder** window, under **Component 1 (comp1)** click **Mesh I**.
- 2 In the **Settings** window for **Mesh**, locate the **Physics-Controlled Mesh** section.
- 3 From the **Element size** list, choose **Finer**.
- 4 Click  **Build All**. The mesh should look like [Figure 3](#).

### STUDY I

#### *Step 1: Ray Tracing*

- 1 In the **Model Builder** window, under **Study I** click **Step 1: Ray Tracing**.
- 2 In the **Settings** window for **Ray Tracing**, locate the **Study Settings** section.
- 3 From the **Time-step specification** list, choose **Specify maximum path length**.
- 4 From the **Length unit** list, choose **mm**.
- 5 In the **Lengths** text field, type 0 1750.
- 6 In the **Home** toolbar, click  **Compute**.

### RESULTS

#### *Ray Diagram*

Now, make some modifications to the default Ray Trajectories plot.

- 1 In the **Settings** window for **3D Plot Group**, type Ray Diagram in the **Label** text field.
- 2 Locate the **Color Legend** section. Select the **Show units** check box.

#### *Ray Trajectories I*

In the **Model Builder** window, expand the **Ray Diagram** node.

#### *Color Expression I*

- 1 In the **Model Builder** window, expand the **Ray Trajectories I** node, then click **Color Expression I**.
- 2 In the **Settings** window for **Color Expression**, locate the **Expression** section.

- 3 In the **Expression** text field, type at ('last',gop.rrel). This expression gives the radial distance from the centroid of the spot on the image plane generated by each release feature.
- 4 From the **Unit** list, choose **µm**.

#### *Filter 1*

- 1 In the **Model Builder** window, click **Filter 1**.
- 2 In the **Settings** window for **Filter**, locate the **Ray Selection** section.
- 3 From the **Rays to include** list, choose **Logical expression**.
- 4 In the **Logical expression for inclusion** text field, type at  $(0, \text{atan2}(qy, qx) > -\pi/2)$ . This filter removes 1/4 of the rays so that the optical geometry is visible.

#### *Ray Diagram*

In the following we add and color surface plots to show the various telescope optical elements.

#### *Surface 1*

- 1 In the **Model Builder** window, right-click **Ray Diagram** and choose **Surface**.
- 2 In the **Settings** window for **Surface**, locate the **Coloring and Style** section.
- 3 From the **Coloring** list, choose **Uniform**.
- 4 From the **Color** list, choose **Custom**.
- 5 On Windows, click the colored bar underneath, or — if you are running the cross-platform desktop — the **Color** button.
- 6 Click **Define custom colors**.
- 7 Set the RGB values to 54, 140, and 203, respectively.
- 8 Click **Add to custom colors**.
- 9 Click **Show color palette only** or **OK** on the cross-platform desktop.

#### *Selection 1*

- 1 Right-click **Surface 1** and choose **Selection**.
- 2 In the **Settings** window for **Selection**, locate the **Selection** section.
- 3 From the **Selection** list, choose **Exterior (Corrector)**.
- 4 Select Boundaries 5–9, 11, 18, 19, 22, and 24 only. Remove the central obstruction and mirror surfaces from this selection.

#### *Transparency 1*

In the **Model Builder** window, right-click **Surface 1** and choose **Transparency**.

### Surface 2

- 1 In the **Model Builder** window, right-click **Ray Diagram** and choose **Surface**.
- 2 In the **Settings** window for **Surface**, locate the **Coloring and Style** section.
- 3 From the **Coloring** list, choose **Uniform**.
- 4 From the **Color** list, choose **Gray**.



### Selection 1

- 1 Right-click **Surface 2** and choose **Selection**.
- 2 In the **Settings** window for **Selection**, locate the **Selection** section.
- 3 From the **Selection** list, choose **Mirrors**.

### Surface 3

- 1 In the **Model Builder** window, right-click **Ray Diagram** and choose **Surface**.
- 2 In the **Settings** window for **Surface**, locate the **Coloring and Style** section.
- 3 From the **Coloring** list, choose **Uniform**.
- 4 From the **Color** list, choose **Custom**.
- 5 On Windows, click the colored bar underneath, or — if you are running the cross-platform desktop — the **Color** button.
- 6 Click **Define custom colors**.
- 7 Set the RGB values to 105, 105, and 105, respectively.
- 8 Click **Add to custom colors**.
- 9 Click **Show color palette only** or **OK** on the cross-platform desktop.

### Selection 1

- 1 Right-click **Surface 3** and choose **Selection**.
- 2 In the **Settings** window for **Selection**, locate the **Selection** section.
- 3 From the **Selection** list, choose **Obstructions**.
- 4 In the **Ray Diagram** toolbar, click  **Plot**.
- 5 Click the  **Zoom Extents** button in the **Graphics** toolbar. Compare the resulting image to [Figure 4](#).



### Spot Diagram

- 1 In the **Home** toolbar, click  **Add Plot Group** and choose **2D Plot Group**.
- 2 In the **Settings** window for **2D Plot Group**, type **Spot Diagram** in the **Label** text field.
- 3 Locate the **Color Legend** section. Select the **Show units** check box.

### *Spot Diagram 1*

- 1 In the **Spot Diagram** toolbar, click  **More Plots** and choose **Spot Diagram**.
- 2 In the **Settings** window for **Spot Diagram**, locate the **Layout** section.
- 3 From the **Origin location** list, choose **Average over area**. This option centers each spot on the midpoint of all rays.
- 4 Click to expand the **Annotations** section. Select the **Show circle** check box.
- 5 In the **Radius** text field, type `r_Airy`. The Airy disc radius was defined in the **Parameters** node.

### *Color Expression 1*

- 1 Right-click **Spot Diagram 1** and choose **Color Expression**.
- 2 In the **Settings** window for **Color Expression**, locate the **Expression** section.
- 3 In the **Expression** text field, type `gop.lamda0`.
- 4 From the **Unit** list, choose **nm**.
- 5 Click to expand the **Range** section. Select the **Manual color range** check box.
- 6 In the **Minimum** text field, type 425.
- 7 In the **Maximum** text field, type 675.
- 8 Locate the **Coloring and Style** section. Click  **Change Color Table**.
- 9 In the **Color Table** dialog box, select **Rainbow>Spectrum** in the tree.
- 10 Click **OK**.
- 11 In the **Spot Diagram** toolbar, click  **Plot**.
- 12 Click the  **Zoom Extents** button in the **Graphics** toolbar. Compare the resulting image to [Figure 5](#).

## *Appendix — Geometry Instructions*



---

From the **File** menu, choose **New**.

### **NEW**

In the **New** window, click  **Model Wizard**.

### **MODEL WIZARD**

- 1 In the **Model Wizard** window, click  **3D**.
- 2 Click  **Done**.

## GREGORY-MAKSUTOV TELESCOPE GEOMETRY SEQUENCE



- 1 In the **Model Builder** window, under **Component 1 (comp1)** click **Geometry 1**.
- 2 In the **Settings** window for **Geometry**, type Gregory-Maksutov Telescope Geometry Sequence in the **Label** text field.
- 3 Locate the **Units** section. From the **Length unit** list, choose **mm**.

## GLOBAL DEFINITIONS

### *Parameters 1*

- 1 In the **Model Builder** window, under **Global Definitions** click **Parameters 1**.
- 2 In the **Settings** window for **Parameters**, locate the **Parameters** section.
- 3 Click  **Load from File**.
- 4 Browse to the model's Application Libraries folder and double-click the file gregory\_maksutov\_telescope\_geom\_sequence\_parameters.txt. This file contains details of the telescope optical prescription.

## PART LIBRARIES

- 1 In the **Home** toolbar, click  **Windows** and choose **Part Libraries**.
- 2 In the **Model Builder** window, under **Component 1 (comp1)** click **Gregory-Maksutov Telescope Geometry Sequence**.
- 3 In the **Part Libraries** window, select **Ray Optics Module>3D>Spherical Lenses>spherical\_lens\_3d** in the tree.
- 4 Click  **Add to Geometry**.
- 5 In the **Select Part Variant** dialog box, select **Specify clear aperture diameter** in the **Select part variant** list.
- 6 Click **OK**.

## GREGORY-MAKSUTOV TELESCOPE GEOMETRY SEQUENCE



### *Corrector*

- 1 In the **Model Builder** window, under **Component 1 (comp1)>Gregory-Maksutov Telescope Geometry Sequence** click **Spherical Lens 3D 1 (pil)**.
- 2 In the **Settings** window for **Part Instance**, type Corrector in the **Label** text field. An aperture on the rear surface of the corrector is also used to define the secondary mirror.

3 Locate the **Input Parameters** section. In the table, enter the following settings:

Name	Expression	Value	Description
R1	R1_corr	-268.62 mm	Radius of curvature, surface 1 (+convex/-concave)
R2	R2_corr	-286.12 mm	Radius of curvature, surface 2 (-convex/+concave)
Tc	Tc_corr	30 mm	Center thickness
d0	d0_corr	225 mm	Lens full diameter
d1	d1_corr	205 mm	Diameter, surface 1
d2	d2_corr	0 m	Diameter, surface 2
d1_clear	d1c_corr	70 mm	Clear aperture diameter, surface 1
d2_clear	d2c_corr	60 mm	Clear aperture diameter, surface 2
nix	nix	0	Local optical axis, x-component
niy	niy	0	Local optical axis, y-component
niz	niz	-1	Local optical axis, z-component

## PART LIBRARIES

- 1 In the **Home** toolbar, click  **Windows** and choose **Part Libraries**.
- 2 In the **Model Builder** window, click **Gregory-Maksutov Telescope Geometry Sequence**.
- 3 In the **Part Libraries** window, select **Ray Optics Module>3D>Mirrors>spherical\_mirror\_3d** in the tree.
- 4 Click  **Add to Geometry**.
- 5 In the **Select Part Variant** dialog box, select **Specify clear aperture diameter** in the **Select part variant** list.
- 6 Click **OK**.

## GREGORY-MAKSUTOV TELESCOPE GEOMETRY SEQUENCE

### Primary mirror

- 1 In the **Model Builder** window, under **Component 1 (comp1)>Gregory-Maksutov Telescope Geometry Sequence** click **Spherical Mirror 3D 1 (pi2)**.
- 2 In the **Settings** window for **Part Instance**, type **Primary mirror** in the **Label** text field.



3 Locate the **Input Parameters** section. In the table, enter the following settings:

Name	Expression	Value	Description
R	R_prim	-1111.6 mm	Radius of curvature (+convex/-concave)
Tc	Tc_prim	25 mm	Center thickness
d0	d0_prim	225 mm	Mirror full diameter
d1	d1_prim	217.5 mm	Mirror surface diameter
d_clear	dc_prim	0 m	Clear aperture diameter
d_hole	dh_prim	60 mm	Center hole diameter
nix	0.0	0	Local optical axis, x-component
niy	0.0	0	Local optical axis, y-component
niz	1.0	1	Local optical axis, z-component

4 Locate the **Position and Orientation of Output** section. Find the **Coordinate system to match** subsection. From the **Take work plane from** list, choose **Corrector (pi1)**.

5 From the **Work plane** list, choose **Surface 2 vertex intersection (wp2)**.

6 Find the **Displacement** subsection. In the **zw** text field, type **z\_prim**.

## PART LIBRARIES

1 In the **Home** toolbar, click  **Windows** and choose **Part Libraries**.

2 In the **Model Builder** window, click **Gregory-Maksutov Telescope Geometry Sequence**.

3 In the **Part Libraries** window, select **Ray Optics Module>3D>Apertures and Obstructions>circular\_planar\_annulus** in the tree.

4 Click  **Add to Geometry**.

## GREGORY-MAKSUTOV TELESCOPE GEOMETRY SEQUENCE

### *Image plane*

1 In the **Model Builder** window, under **Component 1 (comp1)>Gregory-Maksutov Telescope Geometry Sequence** click **Circular Planar Annulus 1 (pi3)**.

2 In the **Settings** window for **Part Instance**, type **Image plane** in the **Label** text field.

3 Locate the **Input Parameters** section. In the table, enter the following settings:

Name	Expression	Value	Description
d0	d0_img	50 mm	Diameter, outer
d1	0.0	0 m	Diameter, inner

4 Locate the **Position and Orientation of Output** section. Find the

**Coordinate system to match** subsection. From the **Take work plane from** list, choose **Primary mirror (pi2)**.

5 From the **Work plane** list, choose **Mirror vertex intersection (wp1)**.

6 Find the **Displacement** subsection. In the **zw** text field, type  $z\_img + \text{delta}_z\_img$ . The image plane z-coordinate is offset to account for the fact that the ray trace is performed in a vacuum.

7 Click  **Build All Objects**.

8 Click the  **Orthographic Projection** button in the **Graphics** toolbar.

9 Click the  **Zoom Extents** button in the **Graphics** toolbar.

In the following sections we create selections that can be used to define the physics and during postprocessing. Note that the predefined Boundary Selections can be used to create custom definitions of clear apertures and obstructions.

*Corrector (pi1)*

1 In the **Model Builder** window, click **Corrector (pi1)**.

2 In the **Settings** window for **Part Instance**, click to expand the **Domain Selections** section.

3 In the table, select the **Keep** check box for **All**.

4 Click to expand the **Boundary Selections** section. In the table, select the **Keep** check boxes for **Exterior** and **Surface 1**.

5 Click to select row number 2 in the table.

6 Click **New Cumulative Selection**.

7 In the **New Cumulative Selection** dialog box, type **Obstructions** in the **Name** text field.

8 Click **OK**.

9 In the **Settings** window for **Part Instance**, locate the **Boundary Selections** section.

10 In the table, enter the following settings:

Name	Keep	Physics	Contribute to
Edges		√	Obstructions

- 11 Click to select row number 3 in the table.
- 12 Click **New Cumulative Selection**.
- 13 In the **New Cumulative Selection** dialog box, type Mirrors in the **Name** text field.
- 14 Click **OK**.
- 15 In the **Settings** window for **Part Instance**, locate the **Boundary Selections** section.
- 16 Click to select row number 4 in the table.
- 17 Click **New Cumulative Selection**.
- 18 In the **New Cumulative Selection** dialog box, type Clear Apertures in the **Name** text field.
- 19 Click **OK**.
- 20 In the **Settings** window for **Part Instance**, locate the **Boundary Selections** section.
- 21 In the table, enter the following settings:

Name	Keep	Physics	Contribute to
Surface 2 obstruction		√	Clear Apertures

*Primary mirror (pi2)*

- 1 In the **Model Builder** window, click **Primary mirror (pi2)**.
- 2 In the **Settings** window for **Part Instance**, locate the **Boundary Selections** section.
- 3 In the table, enter the following settings:

Name	Keep	Physics	Contribute to
Mirror surface		√	Mirrors
Mirror rear surface		√	Obstructions
Mirror edges	√	√	Obstructions

*Image plane (pi3)*

- 1 In the **Model Builder** window, click **Image plane (pi3)**.
- 2 In the **Settings** window for **Part Instance**, locate the **Boundary Selections** section.
- 3 In the table, select the **Keep** check box for **All**.

