

Waveguide Adapter

Introduction

This is a model of an adapter for microwave propagation in the transition between a rectangular and an elliptical waveguide. Such waveguide adapters are designed to keep energy losses due to reflections at a minimum for the operating frequencies. To investigate the characteristics of the adapter, the simulation includes a wave traveling from a rectangular waveguide through the adapter and into an elliptical waveguide. The S-parameters are calculated as functions of the frequency. The involved frequencies are all in the single-mode range of the waveguide, that is, the frequency range where only one mode is propagating in the waveguide.

Model Definition

The waveguide adapter consists of a rectangular part smoothly transcending into an elliptical part as seen in [Figure 1](#).

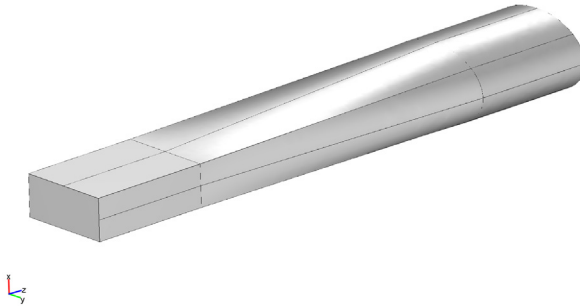

Figure 1: The geometry of the waveguide adapter.

The walls of manufactured waveguides are typically plated with a good conductor such as silver. The model approximates the walls by perfect conductors. This is represented by the boundary condition $\mathbf{n} \times \mathbf{E} = \mathbf{0}$.

The rectangular port is excited by a transverse electric (TE) wave, which is a wave that has no electric field component in the direction of propagation. This is what an incoming wave would look like after traveling through a straight rectangular waveguide with the same cross section as the rectangular part of the adapter. The excitation frequencies are selected

so that the TE₁₀ mode is the only propagating mode through the rectangular waveguide. The cutoff frequencies for the different modes can be achieved analytically from the relation

$$(v_c)_{mn} = \frac{c}{2} \sqrt{\left(\frac{m}{a}\right)^2 + \left(\frac{n}{b}\right)^2}$$

where m and n are the mode numbers, and c is the speed of light. For the TE₁₀ mode, $m = 1$ and $n = 0$. With the dimensions of the rectangular cross section ($a = 2.286$ cm and $b = 1.016$ cm), the TE₁₀ mode is the only propagating mode for frequencies between 6.6 GHz and 14.7 GHz.

Although the shape of the TE₁₀ mode is known analytically, this example lets you compute it using a numerical port. This technique is very general, in that it allows the port boundary to have any shape. The solved equation is

$$\nabla \times (n^{-2} \nabla \times H_n) + (n^{-2} \beta^2 - k_0^2) H_n = 0$$

Here H_n is the component of the magnetic field perpendicular to the boundary, n the refractive index, β the propagation constant in the direction perpendicular to the boundary, and k_0 the free space wave number. The eigenvalues are $\lambda = -j\beta$.

The same equation is solved separately at the elliptical end of the waveguide. The elliptical port is passive, but the eigenmode is still used in the boundary condition of the 3D propagating wave simulation. The dimensions of the elliptical end of the waveguide are such that the frequency range for the lowest propagating mode overlaps that of the rectangular port.

With the stipulated excitation at the rectangular port and the numerically established mode shapes as boundary conditions, the following equation is solved for the electric field vector \mathbf{E} inside the waveguide adapter:

$$\nabla \times (\mu_r^{-1} \nabla \times \mathbf{E}) - k_0^2 \left(\epsilon_r - \frac{j\sigma}{\omega \epsilon_0} \right) \mathbf{E} = 0$$

where μ_r denotes the relative permeability, j the imaginary unit, σ the conductivity, ω the angular frequency, ϵ_r the relative permittivity, and ϵ_0 the permittivity of free space. The model uses the following material properties for free space: $\sigma = 0$ and $\mu_r = \epsilon_r = 1$.

Results

Figure 2 shows a single-mode wave propagating through the waveguide.

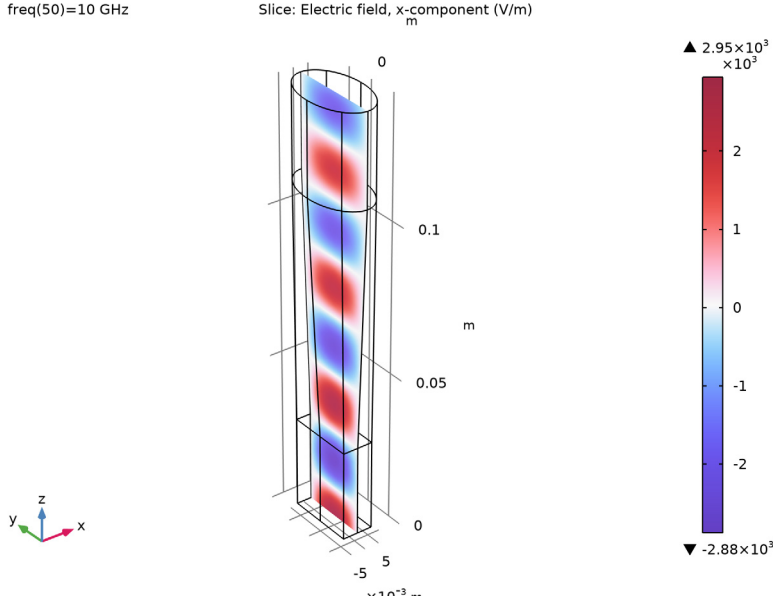

Figure 2: The x component of the propagating wave inside the waveguide adapter at the frequency 10 GHz.

Naming the rectangular port Port 1 and the elliptical port Port 2, the S-parameters describing the reflection and transmission of the wave are defined as follows:

$$S_{11} = \frac{\int_{\text{Port 1}} ((E_c - E_1) \cdot E_1^*) dA_1}{\int_{\text{Port 1}} (E_1 \cdot E_1^*) dA_1}$$

$$S_{21} = \frac{\int_{\text{Port 2}} (E_c \cdot E_2^*) dA_2}{\int_{\text{Port 2}} (E_2 \cdot E_2^*) dA_2}$$

Here E_c is the calculated total field. E_1 is the analytical field for the port excitation, and E_2 is the eigenmode calculated from the boundary mode analysis and normalized with

respect to the outgoing power flow. Figure 3 shows the S_{11} and S_{21} parameters as functions of the frequency.

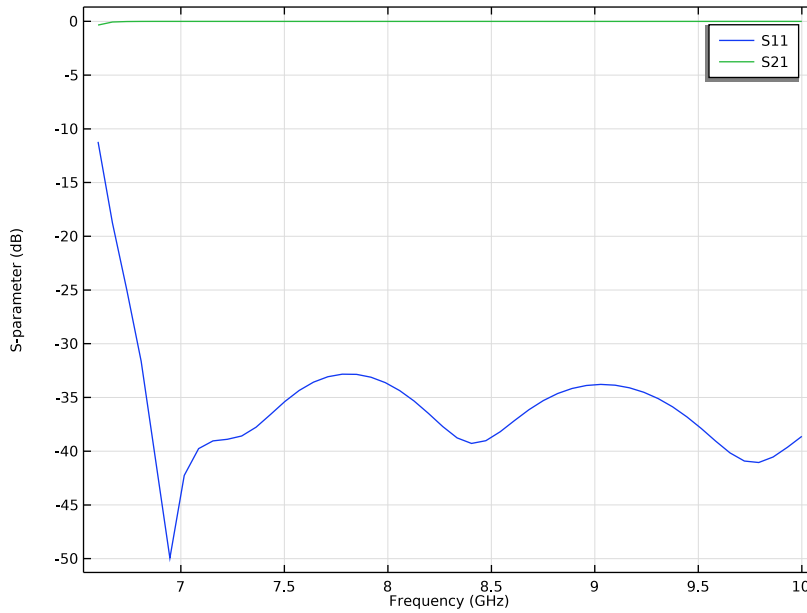



Figure 3: The S_{11} parameter and S_{21} parameter (in dB) as a function of the frequency. This parameter describes the reflections when the waveguide adapter is excited at the rectangular port and a measure of the part of the wave that is transmitted through the elliptical port when the waveguide adapter is excited at the rectangular port, respectively.

Application Library path: RF_Module/Transmission_Lines_and_Waveguides/
waveguide_adapter

Modeling Instructions



From the **File** menu, choose **New**.

NEW

In the **New** window, click  **Model Wizard**.

MODEL WIZARD

I In the **Model Wizard** window, click  **3D**.

- 2 In the **Select Physics** tree, select **Radio Frequency>Electromagnetic Waves, Frequency Domain (emw)**.
- 3 Click **Add**.
- 4 Click  **Study**.
- 5 In the **Select Study** tree, select **Empty Study**.
- 6 Click  **Done**.

STUDY 1

Boundary Mode Analysis

- 1 In the **Study** toolbar, click  **Study Steps** and choose **Other>Boundary Mode Analysis**.
- 2 In the **Settings** window for **Boundary Mode Analysis**, locate the **Study Settings** section.
- 3 In the **Mode analysis frequency** text field, type 7[GHz].

The exact value of this frequency is not important. What matters is that it should be above the cutoff frequency for the fundamental mode, but below that for the next mode. This setting ensures that the boundary mode analysis finds the fundamental mode.

Add another boundary mode analysis, for the second port.

Boundary Mode Analysis 2

- 1 In the **Study** toolbar, click  **Study Steps** and choose **Other>Boundary Mode Analysis**.
- 2 In the **Settings** window for **Boundary Mode Analysis**, locate the **Study Settings** section.
- 3 In the **Port name** text field, type 2.
- 4 In the **Mode analysis frequency** text field, type 7[GHz].

Finally, add the 3D equation for the propagating wave in the waveguide.



Frequency Domain

- 1 In the **Study** toolbar, click  **Study Steps** and choose **Frequency Domain>Frequency Domain**.
- 2 In the **Settings** window for **Frequency Domain**, locate the **Study Settings** section.
- 3 In the **Frequencies** text field, type range (6.6[GHz] , 3.4[GHz] / 49 , 10[GHz]).



Proceed to import the geometry.

GEOMETRY I

Import 1 (imp1)

- 1 In the **Home** toolbar, click  **Import**.
- 2 In the **Settings** window for **Import**, locate the **Import** section.
- 3 Click  **Browse**.
- 4 Browse to the model's Application Libraries folder and double-click the file `waveguide_adapter.mphbin`.
- 5 Click  **Import**.

ADD MATERIAL

- 1 In the **Home** toolbar, click  **Add Material** to open the **Add Material** window.
- 2 Go to the **Add Material** window.
- 3 In the tree, select **Built-in>Air**.
- 4 Click **Add to Component** in the window toolbar.
- 5 In the **Home** toolbar, click  **Add Material** to close the **Add Material** window.

MATERIALS

Air (mat1)

By default, the first material you add applies on all domains so you need not alter any settings.

ELECTROMAGNETIC WAVES, FREQUENCY DOMAIN (EMW)

Port 1

- 1 In the **Model Builder** window, under **Component 1 (comp1)** right-click **Electromagnetic Waves, Frequency Domain (emw)** and choose **Port**.
- 2 In the **Settings** window for **Port**, locate the **Port Properties** section.
- 3 From the **Type of port** list, choose **Numeric**.
For the first port, wave excitation is **on** by default.
- 4 Select Boundary 13 only.
The wave enters the adapter through the port with a rectangular cross section.

Port 2

- 1 In the **Physics** toolbar, click  **Boundaries** and choose **Port**.
- 2 In the **Settings** window for **Port**, locate the **Port Properties** section.

3 From the **Type of port** list, choose **Numeric**.

4 Select Boundary 6 only.

This is the exit port, the one with an elliptical cross section.

MESH 1

In the **Model Builder** window, under **Component 1 (comp1)** right-click **Mesh 1** and choose **Build All**.

STUDY 1

Now set up the study to find the boundary modes and use them when computing the field distribution over a range of frequencies.

Step 1: Boundary Mode Analysis

1 In the **Model Builder** window, under **Study 1** click **Step 1: Boundary Mode Analysis**.

2 In the **Settings** window for **Boundary Mode Analysis**, locate the **Study Settings** section.

3 In the **Search for modes around** text field, type 50.

This value should be in the vicinity of the value that you expect the fundamental mode to have. If you do not know this in advance, you can experiment with some different values or estimate one from analytical formulas valid for cross sections resembling yours.

4 From the **Transform** list, choose **Out-of-plane wave number**.

Step 2: Boundary Mode Analysis 2

1 In the **Model Builder** window, click **Step 2: Boundary Mode Analysis 2**.

2 In the **Settings** window for **Boundary Mode Analysis**, locate the **Study Settings** section.

3 In the **Search for modes around** text field, type 50.

4 From the **Transform** list, choose **Out-of-plane wave number**.

5 In the **Home** toolbar, click  **Compute**.

RESULTS

Electric Field (emw)

- 1 Click the  **Zoom Extents** button in the **Graphics** toolbar.

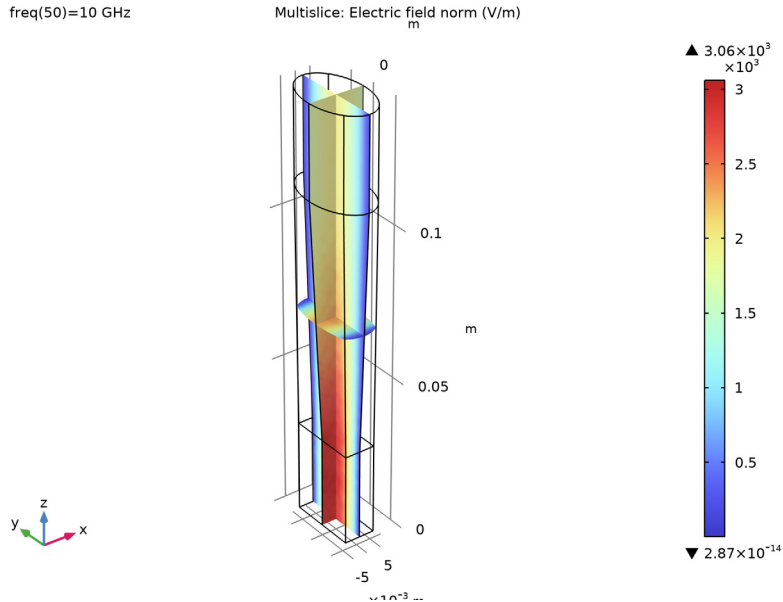

The default plot shows the norm of the electric field on slices through the waveguide; you can simplify and improve this plot.

Delete the Multislice plot.

Multislice

- 1 In the **Model Builder** window, expand the **Electric Field (emw)** node.
- 2 Right-click **Results>Electric Field (emw)>Multislice** and choose **Delete**.

Slice 1

- 1 In the **Model Builder** window, right-click **Electric Field (emw)** and choose **Slice**.
- 2 In the **Settings** window for **Slice**, click **Replace Expression** in the upper-right corner of the **Expression** section. From the menu, choose **Component 1 (comp1)>Electromagnetic Waves, Frequency Domain>Electric>Electric field - V/m>emw.Ex - Electric field, x-component**.
- 3 Locate the **Coloring and Style** section. Click  **Change Color Table**.
- 4 In the **Color Table** dialog box, select **Wave>WaveLight** in the tree.

5 Click **OK**.

6 In the **Settings** window for **Slice**, locate the **Plane Data** section.

7 In the **Planes** text field, type 1.

8 In the **Electric Field (emw)** toolbar, click  **Plot**.

The plot now shows the x component of the electric field at the highest frequency, 10 GHz (compare with [Figure 2](#)). If you would like to see the field for other frequencies, you can select them by clicking on the **Electric Field (emw)** plot group.

Proceed by checking the plot of the S-parameters as functions of the frequency.

S-parameter (emw)

Select the **S-Parameter (emw)** plot group under **Results** in Model Builder. The plot should closely resemble that in [Figure 3](#).

Smith Plot (emw)

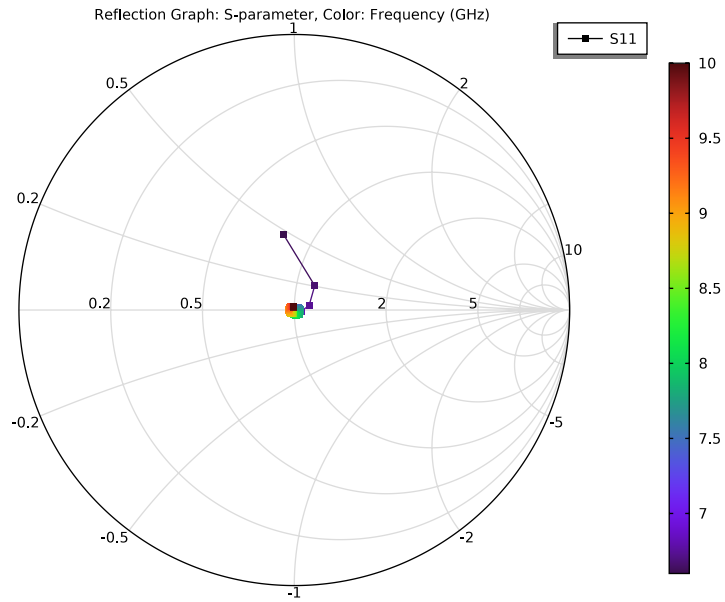

Electric Mode Field, Port 1 (emw)

freq(50)=10 GHz

Surface: Tangential boundary mode electric field norm (V/m)

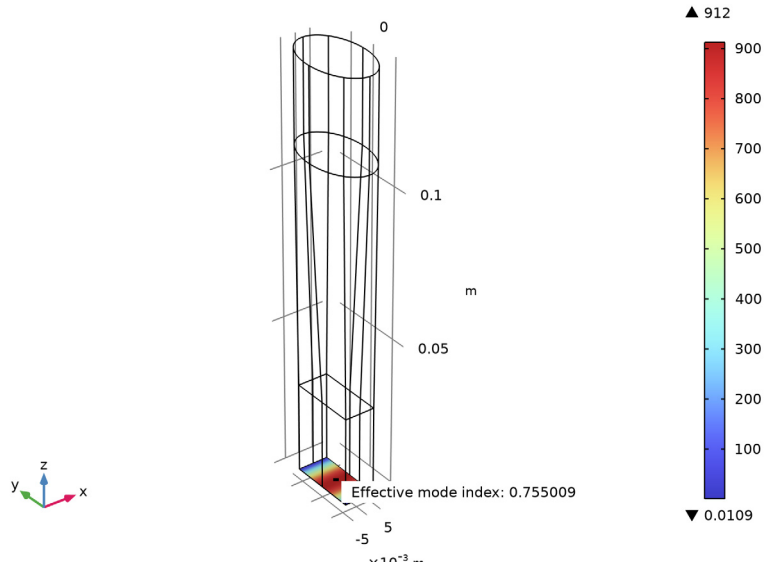

Electric Mode Field, Port 2 (emw)

freq(50)=10 GHz

Surface: Tangential boundary mode electric field norm (V/m)

