



Substrate Integrated Waveguide Leaky Wave Antenna

Introduction

Substrate Integrated Waveguides (SIW) can be used in antenna applications. Leaky waves from a slot array on the top surface of the SIW in this example generate a beam in a certain direction that can be steered by choosing a different operating frequency.

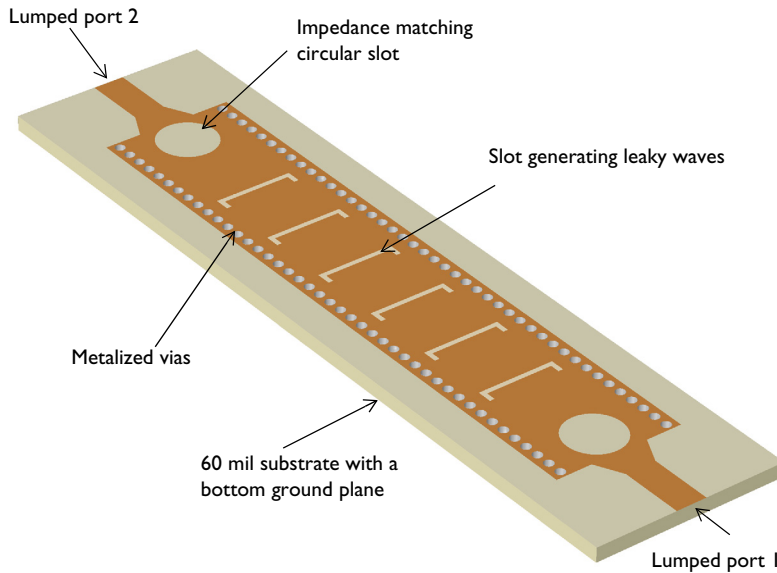

Figure 1: A SIW is realized using 60 mil microwave substrate. The side walls are terminated with metalized via holes. The input and output microstrip lines are connected to the SIW via tapered lines.

Model Definition

Substrate integrated waveguides (SIWs) are widely used because they are easy to fabricate and slotted patterns of any shape can be drawn on the top surface. The leaky wave antenna in this example uses a SIW which is simply realized by using a microstrip line type structure. In the SIW, a 50Ω microstrip line at the input and output is linearly tapered to a wider line in the middle of a 60 mil substrate with $\epsilon_r = 3.38$ (Figure 1). The microstrip line and the ground plane work as the top and bottom walls of a waveguide and the side walls are built by adding metallic vias between the wider part of a microstrip line and the ground plane. All metallic parts are modeled using perfect electric conductor (PEC). There is a circular slot on each tapered line for the impedance matching to 50Ω . Six slots are placed on the top surface of the microstrip line for a leaky wave radiation. The antenna

is modeled in a spherical air domain. The air domain is truncated with Perfectly Matched Layers (PMLs) which absorb all outgoing radiation.

The cutoff frequency of the SIW is calculated using the equation from the rectangular waveguide which is defined by

$$f_{cmn} = \frac{c}{2\pi\sqrt{\epsilon_r\mu_r}} \sqrt{\left(\frac{m\pi}{a}\right)^2 + \left(\frac{n\pi}{b}\right)^2}$$

where a and b are the dimension of a waveguide aperture. Here, a and b are replaced by the width of the wider line and thickness of the substrate, respectively. The calculated cutoff frequency of the SIW is 7.765 GHz with $a = 10.5$ mm at TE₁₀ mode. The operating frequency of the leaky wave antenna should be higher than the SIW cutoff frequency.

All domains except the PMLs are meshed by a tetrahedral mesh with maximum element size of five elements per wavelength so that the wave is well-resolved. The PMLs are swept with a total of five elements along the absorbing direction.

Results and Discussion

[Figure 2](#) shows the default electric field norm plot in the xy -plane. The intensity of the electric fields coupled to each slot is getting weaker from the import to the export direction. The phase of the electric fields coupled to each slot is arithmetically changing because the wave is traveling inside the SIW.

The combination of these two defines the magnitude and phase properties of the weight function for a slot array antenna. The direction of the maximum radiation of the SIW leaky wave antenna can be steered by controlling the operating frequency that changes the weight function.

The side view of the radiation pattern in a polar format is plotted in [Figure 3](#). The 3D far-field radiation pattern is visualized in [Figure 4](#). Though the slots are open to the upward direction, the radiation pattern is tilted toward the export at 12.25 GHz because of the leaky wave coupling among the slots with different magnitudes and phases.

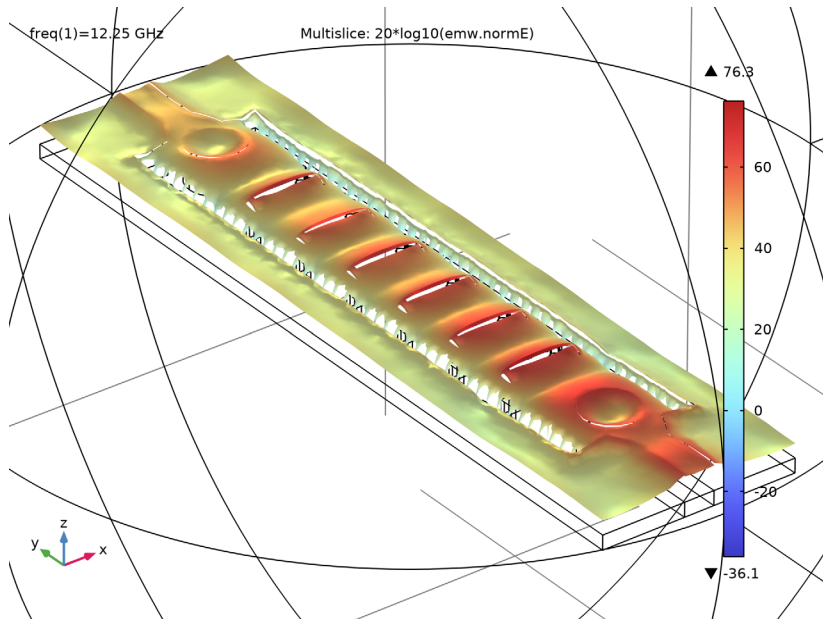

Figure 2: The electric field norm plot in the xy -plane shows the energy leaked via slots.

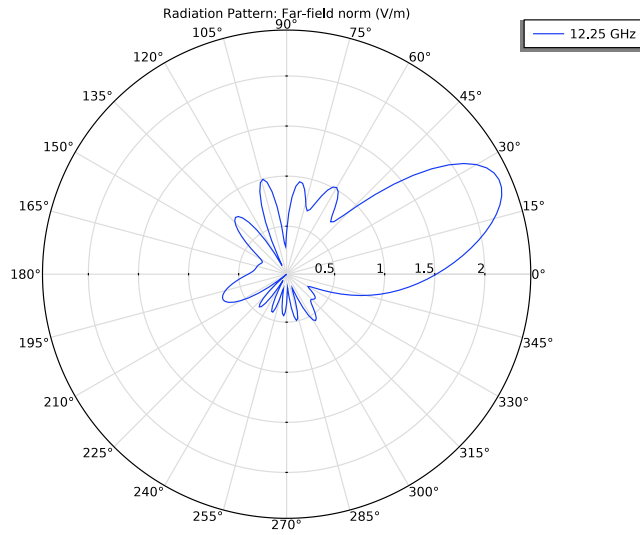

Figure 3: The x-axis cut polar plot of the far-field radiation pattern.

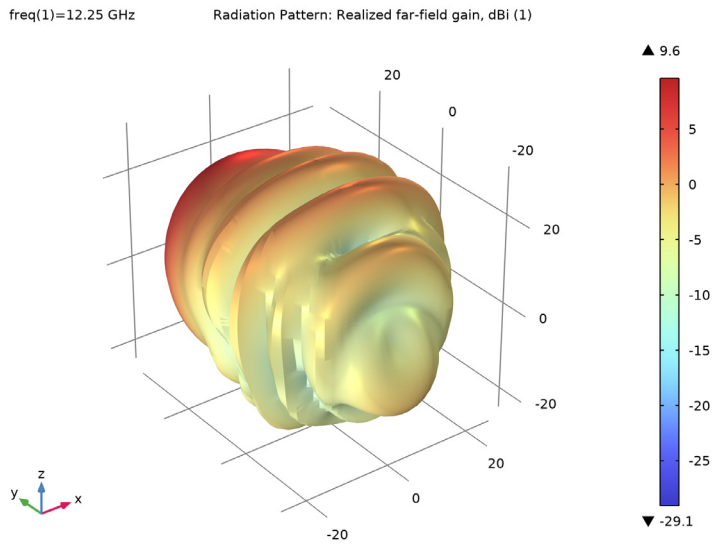



Figure 4: The 3D far-field radiation pattern is tilted toward the positive y-axis.

Application Library path: RF_Module/Antenna_Arrays/siw_leaky_wave_antenna



Modeling Instructions

From the **File** menu, choose **New**.

NEW

In the **New** window, click  **Model Wizard**.

MODEL WIZARD

- 1 In the **Model Wizard** window, click  **3D**.
- 2 In the **Select Physics** tree, select **Radio Frequency>Electromagnetic Waves, Frequency Domain (emw)**.
- 3 Click **Add**.
- 4 Click  **Study**.
- 5 In the **Select Study** tree, select **General Studies>Frequency Domain**.
- 6 Click  **Done**.

STUDY I

Step 1: Frequency Domain

- 1 In the **Model Builder** window, under **Study I** click **Step 1: Frequency Domain**.
- 2 In the **Settings** window for **Frequency Domain**, locate the **Study Settings** section.
- 3 In the **Frequencies** text field, type 12.25[GHz].

GEOMETRY I

- 1 In the **Model Builder** window, under **Component 1 (comp1)** click **Geometry I**.
- 2 In the **Settings** window for **Geometry**, locate the **Units** section.
- 3 From the **Length unit** list, choose **mm**.



Work Plane 1 (wp1)

In the **Geometry** toolbar, click  **Work Plane**.



Work Plane 1 (wp1)>Plane Geometry

In the **Model Builder** window, click **Plane Geometry**.

Work Plane 1 (wpl) > Import 1 (imp1)

- 1 In the **Home** toolbar, click  **Import**.
- 2 In the **Settings** window for **Import**, locate the **Import** section.
- 3 Click  **Browse**.
- 4 Browse to the model's Application Libraries folder and double-click the file `siw_leaky_wave_antenna.mphbin`.
- 5 Click  **Import**.

Block 1 (blk1)

- 1 In the **Model Builder** window, right-click **Geometry 1** and choose **Block**.
- 2 In the **Settings** window for **Block**, locate the **Size and Shape** section.
- 3 In the **Width** text field, type 21.
- 4 In the **Depth** text field, type 83.
- 5 In the **Height** text field, type 1.524.
- 6 Locate the **Position** section. From the **Base** list, choose **Center**.
- 7 In the **z** text field, type $-1.524/2$.
- 8 Click  **Build Selected**.
- 9 Click the  **Wireframe Rendering** button in the **Graphics** toolbar.

Extrude 1 (ext1)

- 1 In the **Geometry** toolbar, click  **Extrude**.
- 2 In the **Settings** window for **Extrude**, locate the **Distances** section.
- 3 In the table, enter the following settings:

Distances (mm)
-1.524

- 4 Click  **Build Selected**.

Sphere 1 (sph1)

- 1 In the **Geometry** toolbar, click  **Sphere**.
- 2 In the **Settings** window for **Sphere**, locate the **Size** section.
- 3 In the **Radius** text field, type 65.

4 Click to expand the **Layers** section. In the table, enter the following settings:

Layer name	Thickness (mm)
Layer 1	20

5 Click  **Build All Objects**.

6 Click the  **Zoom Extents** button in the **Graphics** toolbar.

7 Click the  **Zoom In** button in the **Graphics** toolbar.

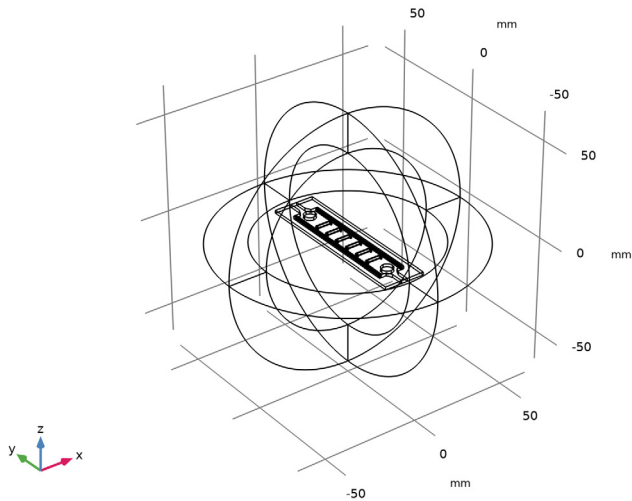

The finished geometry should look like this.

DEFINITIONS

Perfectly Matched Layer 1 (pml1)

1 In the **Definitions** toolbar, click  **Perfectly Matched Layer**.

2 Select Domains 1–4 and 59–62 only.

3 In the **Settings** window for **Perfectly Matched Layer**, locate the **Geometry** section.

4 From the **Type** list, choose **Spherical**.

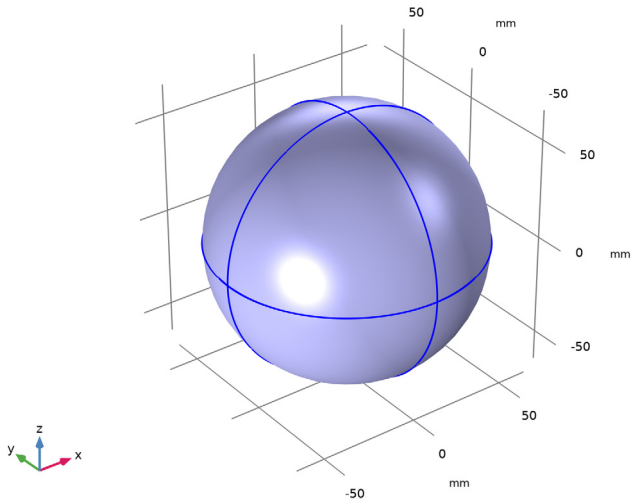

ELECTROMAGNETIC WAVES, FREQUENCY DOMAIN (EMW)

Remove vias from the model domain. Then, PEC boundary condition is applied by default on the boundaries of vias.

- 1 In the **Model Builder** window, under **Component 1 (comp1)** click **Electromagnetic Waves, Frequency Domain (emw)**.
- 2 In the **Settings** window for **Electromagnetic Waves, Frequency Domain**, locate the **Domain Selection** section.
- 3 Click  **Clear Selection**.

4 Select Domains 1–7 and 51–63 only.

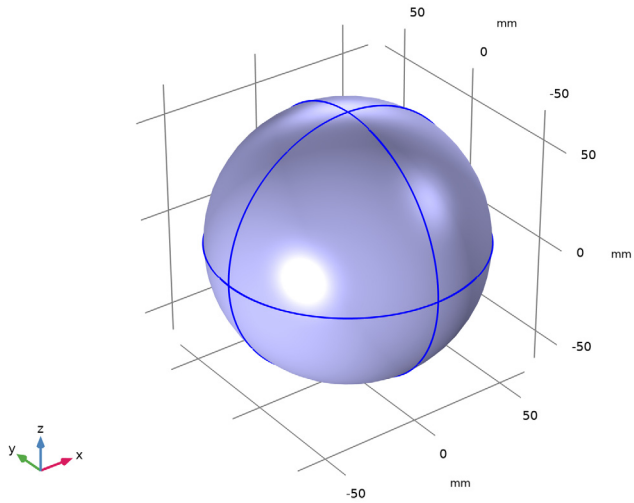

Perfect Electric Conductor 2

1 In the **Physics** toolbar, click  **Boundaries** and choose **Perfect Electric Conductor**.

2 Select Boundaries 15, 20, 21, 283, 289, 295, 301, 307, 313, 332, 336, and 365 only.

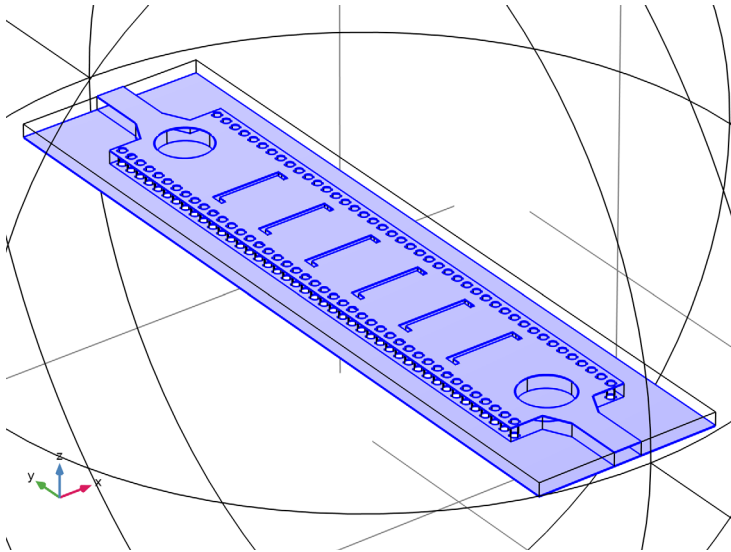

Lumped Port 1

1 In the **Physics** toolbar, click  **Boundaries** and choose **Lumped Port**.

2 Select Boundary 340 only.

For the first port, wave excitation is **on** by default.

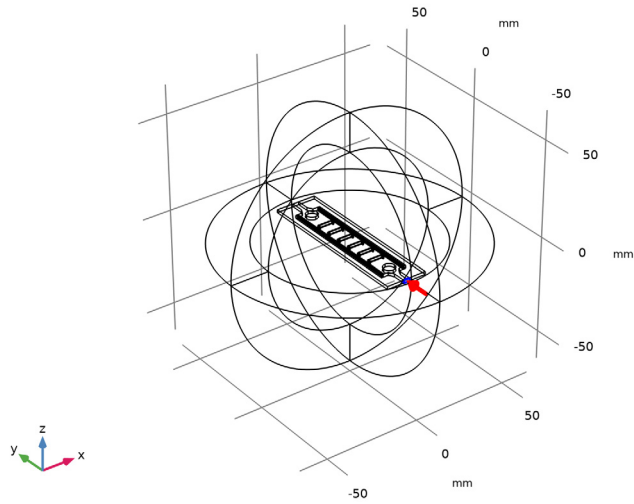

Lumped Port 2

1 In the **Physics** toolbar, click  **Boundaries** and choose **Lumped Port**.

2 Select Boundary 342 only.

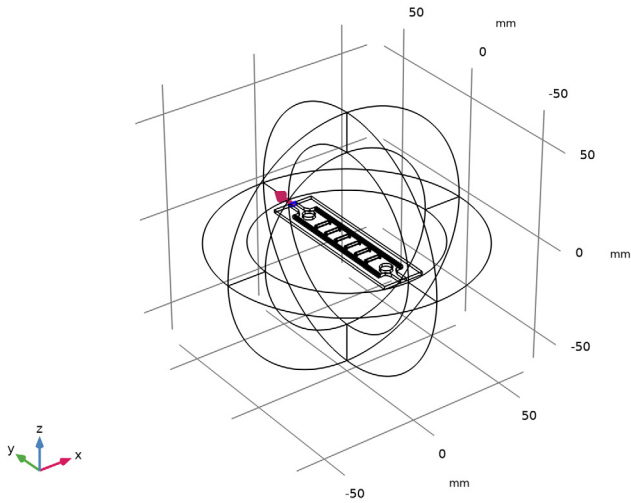

Far-Field Domain 1

In the **Physics** toolbar, click  **Domains** and choose **Far-Field Domain**.

MATERIALS

Material 1 (mat1)

- 1 In the **Model Builder** window, under **Component 1 (comp1)** right-click **Materials** and choose **Blank Material**.
- 2 In the **Settings** window for **Material**, locate the **Material Contents** section.
- 3 In the table, enter the following settings:

Property	Variable	Value	Unit	Property group
Relative permittivity	epsilon _{nr_} iso ; epsilon _{nrii} = epsilon _{nr_} iso, epsilon _{nrij} = 0	1		Basic

Property	Variable	Value	Unit	Property group
Relative permeability	mur_iso ; murii = mur_iso, murij = 0	1		Basic
Electrical conductivity	sigma_iso ; sigmai = sigma_iso, sigmaj = 0	0	S/m	Basic

Material 2 (mat2)

- 1 Right-click **Materials** and choose **Blank Material**.
- 2 Select Domains 6, 7, 51–58, and 63 only.

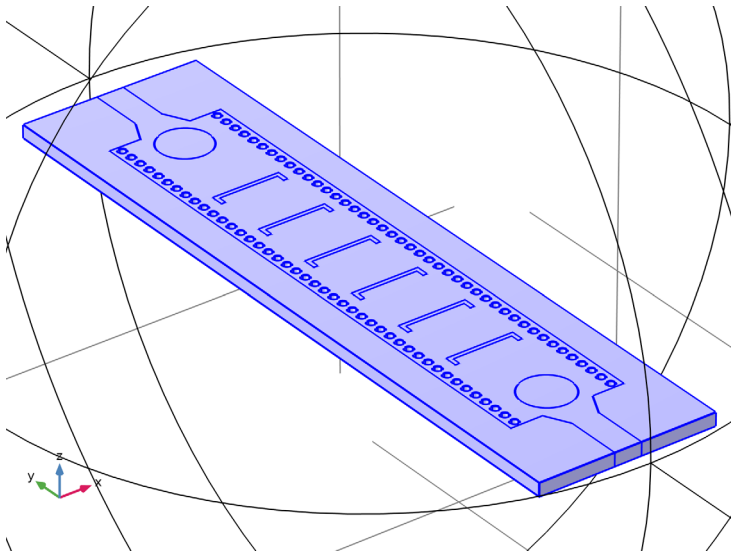

- 3 In the **Settings** window for **Material**, locate the **Material Contents** section.

4 In the table, enter the following settings:

Property	Variable	Value	Unit	Property group
Relative permittivity	epsilon _{r_} iso ; epsilon _{r_} ii = epsilon _{r_} iso, epsilon _{r_} ij = 0	3.38		Basic
Relative permeability	mu _{r_} iso ; mu _{r_} ii = mu _{r_} iso, mu _{r_} ij = 0	1		Basic
Electrical conductivity	sigma _{iso} ; sigma _{ii} = sigma _{iso} , sigma _{ij} = 0	0	S/m	Basic

5 Locate the **Geometric Entity Selection** section. Click  **Create Selection**.

6 In the **Create Selection** dialog box, type Substrate in the **Selection name** text field.

7 Click **OK**.

MESH 1

1 In the **Model Builder** window, under **Component 1 (comp1)** click **Mesh 1**.

2 In the **Settings** window for **Mesh**, locate the **Physics-Controlled Mesh** section.

3 From the **Element size** list, choose **Coarser**.

4 Click  **Build All**.

DEFINITIONS

Hide for Physics 1

1 In the **Model Builder** window, right-click **View 1** and choose **Hide for Physics**.

2 Select Domains 2 and 4 only.

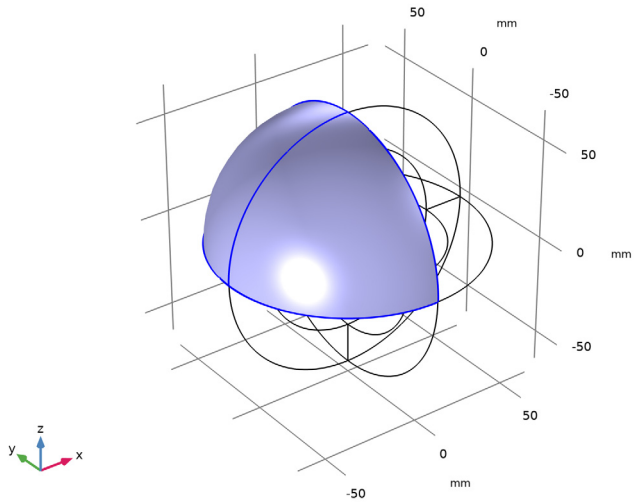

Hide for Physics 2

- 1 Right-click **View 1** and choose **Hide for Physics**.
- 2 In the **Settings** window for **Hide for Physics**, locate the **Geometric Entity Selection** section.
- 3 From the **Geometric entity level** list, choose **Boundary**.

4 Select Boundaries 10 and 12 only.

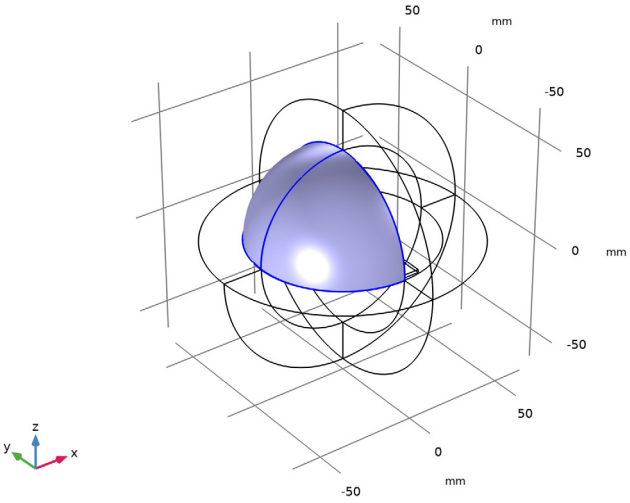

MESH 1

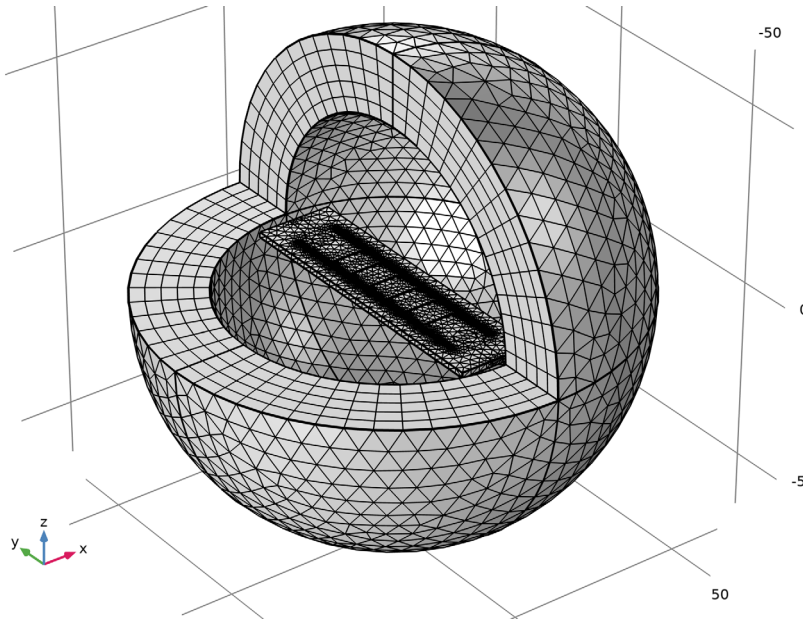

STUDY 1

In the **Home** toolbar, click  **Compute**.

RESULTS

Multislice

- 1 In the **Model Builder** window, expand the **Results>Electric Field (emw)** node, then click **Multislice**.
- 2 In the **Settings** window for **Multislice**, locate the **Expression** section.
- 3 In the **Expression** text field, type $20 * \log_{10}(\text{emw}.\text{normE})$.
Modify the settings to show the plot only on the *xy*-plane.
- 4 Locate the **Multipane Data** section. Find the **X-planes** subsection. In the **Planes** text field, type 0.
- 5 Find the **Y-planes** subsection. In the **Planes** text field, type 0.
- 6 Find the **Z-planes** subsection. From the **Entry method** list, choose **Coordinates**.
- 7 In the **Coordinates** text field, type 0.

Selection 1

- 1 Right-click **Multislice** and choose **Selection**.
- 2 In the **Settings** window for **Selection**, locate the **Selection** section.
- 3 From the **Selection** list, choose **Substrate**.
- 4 Click the  **Zoom to Selection** button in the **Graphics** toolbar.

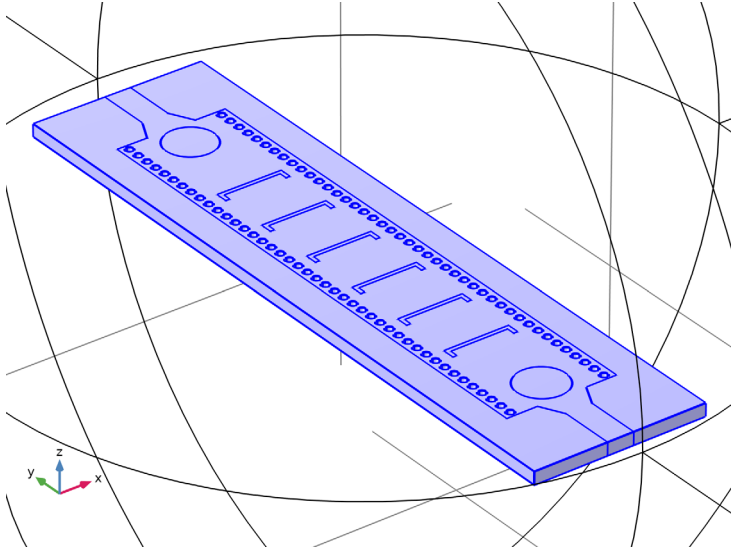

Deformation 1

- 1 Right-click **Multislice** and choose **Deformation**.
- 2 In the **Settings** window for **Deformation**, locate the **Expression** section.
- 3 In the **X-component** text field, type 0.
- 4 In the **Y-component** text field, type 0.
- 5 In the **Z-component** text field, type $20 \cdot \log_{10}(\text{emw}.\text{normE})$.
- 6 In the **Electric Field (emw)** toolbar, click  **Plot**.
See [Figure 2](#)).

Radiation Pattern 1

- 1 In the **Model Builder** window, expand the **Results>2D Far Field (emw)** node, then click **Radiation Pattern 1**.
- 2 In the **Settings** window for **Radiation Pattern**, locate the **Evaluation** section.
- 3 Find the **Reference direction** subsection. In the **x** text field, type 0.

- 4 In the **y** text field, type 1.
- 5 Find the **Normal vector** subsection. In the **x** text field, type 1.
- 6 In the **z** text field, type 0.
- 7 In the **2D Far Field (emw)** toolbar, click  **Plot**.

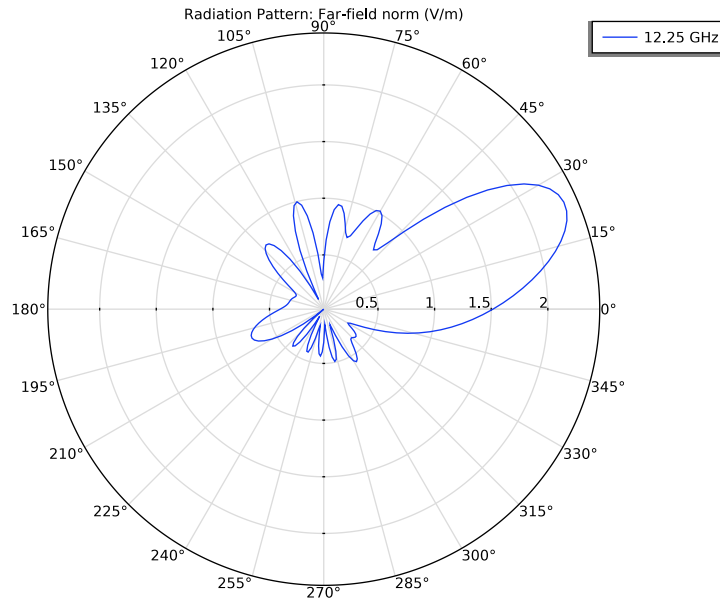

Radiation Pattern I

- 1 In the **Model Builder** window, expand the **3D Far Field, Gain (emw)** node, then click **Radiation Pattern I**.
- 2 In the **Settings** window for **Radiation Pattern**, locate the **Evaluation** section.
- 3 Find the **Angles** subsection. In the **Number of elevation angles** text field, type 90.
- 4 In the **Number of azimuth angles** text field, type 90.
- 5 In the **3D Far Field, Gain (emw)** toolbar, click  **Plot**.

TABLE

- 1 Go to the **Table** window.

This plot shows the 3D far-field radiation pattern ([Figure 3](#)).

RESULTS

Inspect the input matching (S_{11}) at the simulated frequency.

