

RF Coil

Introduction

RF coils are important in numerous applications, ranging from wireless technology to MRI scanning equipment. This introductory tutorial model demonstrates how to find the fundamental resonance frequency of a coil, and perform a frequency sweep to extract its Q factor.

Model Definition

The considered coil consists of two turns, as shown in [Figure 1](#). In the first version of the example, this geometry is used in finding the fundamental resonance. The coil is considered to be a perfect electric conductor, which means you need to solve the eigenfrequency equation for the electromagnetic waves only in its surrounding air. The air domain is a sphere sufficiently large that its exterior boundary conditions do not considerably affect the solution.

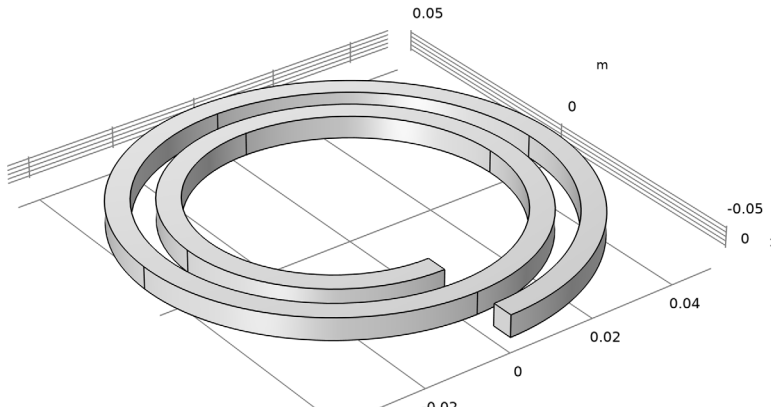

Figure 1: Geometry used for the eigenfrequency analysis.

In the second version of the example, a time-harmonic driving port voltage is assigned between the two ends of the coil. This is accomplished by connecting them through a *lumped port* (see *Lumped Ports with Voltage Input* in the *RF Module User's Guide*). The port is assigned a 50Ω external cable impedance and a 1 V driving voltage. The model is run through a range of frequencies surrounding the resonance.

In order to let the generated waves leave the model domain with a minimum of artificial reflections, the driven version of the example has a PML outside the air sphere. [Figure 2](#) shows the meshed geometry.

The driven model considers the coil as made of copper. It accounts for the conductive surface losses with the help of an *Impedance Boundary Condition* (see the *RF Module User's Guide*).

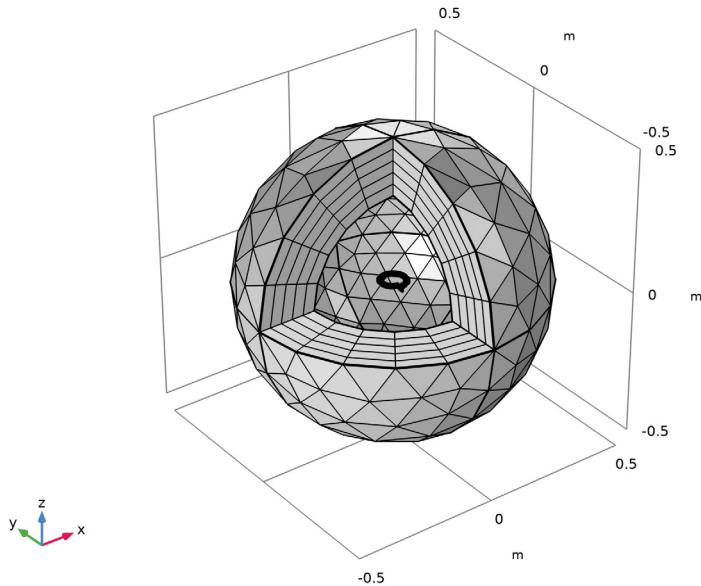

Figure 2: The mesh used in the driven version of the example. A slice is cut out and the air domain made invisible in order to show the coil.

Results and Discussion

The eigenfrequency version of the example finds the lowest eigenfrequency at 180 MHz. In order to verify that the air sphere is sufficiently large, this result is confirmed with the artificial exterior boundaries set first to perfect electric conductors, then to perfect magnetic conductors. [Figure 3](#) shows the distribution of the electric and magnetic fields at this resonance.

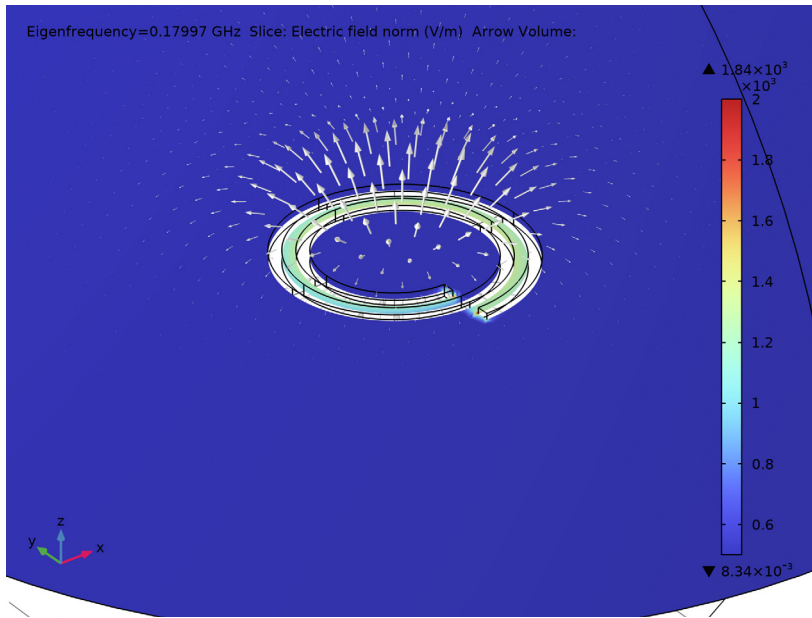

Figure 3: Electric field (slice) and magnetic flux density (arrows) at the fundamental resonance.

The lumped port condition in the driven problem automatically provides the impedance of the example. This is the input impedance to the cable; as such it is independent of the 50Ω cable impedance. Plotting the impedance versus the frequency lets you evaluate the Q factor of the device:

$$Q = \frac{f_0}{\Delta f},$$

where f_0 is the peak frequency and Δf the full width at half maximum, as seen in [Figure 4](#).

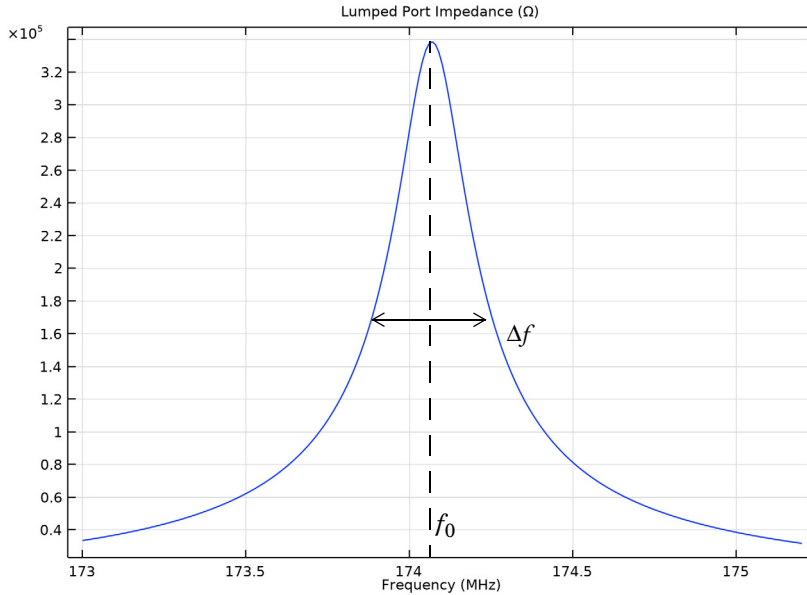



Figure 4: Input impedance versus frequency. The Q -value evaluates to approximately 400.

Application Library path: RF_Module/Passive_Devices/rf_coil

Modeling Instructions

From the **File** menu, choose **New**.

NEW

In the **New** window, click  **Model Wizard**.

MODEL WIZARD

- 1 In the **Model Wizard** window, click  **3D**.
- 2 In the **Select Physics** tree, select **Radio Frequency>Electromagnetic Waves, Frequency Domain (emw)**.
- 3 Click **Add**.

4 Click  **Study**.

Begin with the **Eigenfrequency** study. You add another **Frequency Domain** study later.

5 In the **Select Study** tree, select **General Studies>Eigenfrequency**.

6 Click  **Done**.

GEOMETRY I

Import 1 (impl)

1 In the **Home** toolbar, click  **Import**.

2 In the **Settings** window for **Import**, locate the **Import** section.

3 Click  **Browse**.

4 Browse to the model's Application Libraries folder and double-click the file `rf_coil.mphbin`.

5 Click  **Import**.

Create an air sphere surrounding the coil.

Sphere 1 (sph1)

1 In the **Geometry** toolbar, click  **Sphere**.

2 In the **Settings** window for **Sphere**, locate the **Size** section.

3 In the **Radius** text field, type 0.25.

4 Click  **Build All Objects**.

5 Click the  **Zoom Extents** button in the **Graphics** toolbar.

6 Click the  **Transparency** button in the **Graphics** toolbar.

ADD MATERIAL

1 In the **Home** toolbar, click  **Add Material** to open the **Add Material** window.

2 Go to the **Add Material** window.

3 In the tree, select **Built-in>Air**.

4 Click **Add to Component** in the window toolbar.

5 In the **Home** toolbar, click  **Add Material** to close the **Add Material** window.

MATERIALS

Air (mat1)

The first material that you choose, in this case air, by default applies to all domains. This is fine, as you are anyway going to exclude the interior of the coil from the model in the next step.

ELECTROMAGNETIC WAVES, FREQUENCY DOMAIN (EMW)

1 In the **Model Builder** window, under **Component 1 (comp1)** click **Electromagnetic Waves, Frequency Domain (emw)**.

2 Select Domain 1 only.

With the coil domain removed from the model, the coil surface will by default get the Perfect Electric Conductor boundary condition. This will also apply to the exterior boundaries of the air domain.

Given that the air domain is sufficiently large, the condition on its exterior boundaries should have a limited effect on the result. To verify that this is the case, you will solve this model once with the default Perfect Electric Conductor condition and once with the Perfect Magnetic Conductor condition. The difference between the resulting eigenfrequencies will give you an idea of the accuracy of the results, and the mean of the two solutions should be a good estimate of the actual value.

MESH 1

Free Tetrahedral 1

In the **Mesh** toolbar, click  **Free Tetrahedral**.

Size 1

1 Right-click **Free Tetrahedral 1** and choose **Size**.

2 In the **Settings** window for **Size**, locate the **Geometric Entity Selection** section.

3 From the **Geometric entity level** list, choose **Domain**.

4 Select Domain 2 only.

5 Locate the **Element Size** section. From the **Predefined** list, choose **Fine**.

6 Click the **Custom** button.

7 Locate the **Element Size Parameters** section.

8 Select the **Maximum element size** check box. In the associated text field, type 0.005.

The 5 mm maximum element size in the coil domain helps you get a relatively uniform mesh in the vicinity of the coil.

9 Click  **Build All**.

STUDY 1

Step 1: Eigenfrequency

By default, the eigenfrequency solver will return six eigenfrequencies. However, by requesting only one eigenfrequency, the solver will only return the true physical solution around 180 MHz and not the lower frequency spurious solutions.

- 1 In the **Model Builder** window, under **Study 1** click **Step 1: Eigenfrequency**.
- 2 In the **Settings** window for **Eigenfrequency**, locate the **Study Settings** section.
- 3 In the **Search for eigenfrequencies around** text field, type 180[MHz].
- 4 Select the **Desired number of eigenfrequencies** check box. In the associated text field, type 1.
- 5 In the **Home** toolbar, click  **Compute**.

RESULTS

Electric Field (emw)

The Eigenfrequency list should contain a solution of the order of 180 MHz. If the eigenfrequency in the list is something else, the solver has probably returned a spurious solution. If you suspect that the solver has returned a spurious solution, it helps to plot the fields and verify that the solution contains only noise. In that case, redo the calculation with more eigenfrequencies and select the eigenfrequency around 180 MHz. For now, display a slice plot of the electric field distribution for the eigenfrequency around 180 MHz.

Replace the Multislice plot with a single slice.

Multislice

- 1 In the **Model Builder** window, expand the **Electric Field (emw)** node.
- 2 Right-click **Results>Electric Field (emw)>Multislice** and choose **Delete**.

Slice 1

- 1 In the **Model Builder** window, right-click **Electric Field (emw)** and choose **Slice**.
- 2 In the **Settings** window for **Slice**, locate the **Plane Data** section.
- 3 From the **Plane** list, choose **XY-planes**.
- 4 In the **Planes** text field, type 1.
- 5 In the **Electric Field (emw)** toolbar, click  **Plot**.

6 Click the  **Transparency** button in the **Graphics** toolbar.

7 Click the  **Zoom In** button in the **Graphics** toolbar twice.

It is clear that the electric field is much greater between the turns of the coil than anywhere else. You can get a better view of the distribution within the coil by adjusting the range a little. Add an arrow plot of the magnetic flux density to reproduce [Figure 3](#).

8 Click to expand the **Range** section. Select the **Manual color range** check box.

9 In the **Minimum** text field, type 500.

10 In the **Maximum** text field, type 2000.

11 In the **Electric Field (emw)** toolbar, click  **Plot**.

Arrow Volume 1

1 Right-click **Electric Field (emw)** and choose **Arrow Volume**.

2 In the **Settings** window for **Arrow Volume**, click **Replace Expression** in the upper-right corner of the **Expression** section. From the menu, choose **Component 1 (comp1) > Electromagnetic Waves, Frequency Domain > Magnetic > emw.Bx, ..., emw.Bz - Magnetic flux density**.

The selection you just made would give you an arrow plot of the real part of the magnetic flux density. Because the magnetic fields are 90 degrees out of phase with the electric potential applied by the port, that evaluates to zero. Adjust the expressions manually to look at the imaginary part instead.

3 Locate the **Expression** section. In the **X-component** text field, type $\text{imag}(\text{emw.Bx})$.

4 In the **Y-component** text field, type $\text{imag}(\text{emw.By})$.

5 In the **Z-component** text field, type $\text{imag}(\text{emw.Bz})$.

6 Locate the **Arrow Positioning** section. Find the **X grid points** subsection. In the **Points** text field, type 45.

7 Find the **Y grid points** subsection. In the **Points** text field, type 45.

8 Find the **Z grid points** subsection. In the **Points** text field, type 10.

9 Locate the **Coloring and Style** section. From the **Color** list, choose **White**.

10 In the **Electric Field (emw)** toolbar, click  **Plot**.

These are all the exterior boundaries of the air domain.

ELECTROMAGNETIC WAVES, FREQUENCY DOMAIN (EMW)

Perfect Magnetic Conductor 1

1 In the **Physics** toolbar, click  **Boundaries** and choose **Perfect Magnetic Conductor**.

- 2 Click the  **Zoom Extents** button in the **Graphics** toolbar.
- 3 Select Boundaries 1–4, 15, 16, 23, and 24 only.

STUDY 1

In the **Home** toolbar, click  **Compute**.

RESULTS

Electric Field (emw)

- 1 In the **Electric Field (emw)** toolbar, click  **Plot**.

The fundamental eigenfrequency is now slightly lower than before. The difference is so small that the numerical error due to the finite mesh is likely greater than the systematic error due to the outer boundary condition.

In the driven problem, not only the resonance frequency but also the radiation losses are important. These are better captured if the size of the geometry is of the same order of magnitude as the wavelength. Because the driven analysis uses a highly memory-efficient iterative solver, you can afford to increase the size of the sphere a little.

GEOMETRY 1

Sphere 1 (sph1)

- 1 In the **Model Builder** window, under **Component 1 (comp1)>Geometry 1** click **Sphere 1 (sph1)**.
- 2 In the **Settings** window for **Sphere**, locate the **Size** section.
- 3 In the **Radius** text field, type 0.5.
First, add a PML layer to the sphere.
- 4 Click to expand the **Layers** section. In the table, enter the following settings:

Layer name	Thickness (m)
Layer 1	0.2

- 5 Click the  **Wireframe Rendering** button in the **Graphics** toolbar.



Next, create a work plane to draw and embed rectangles for your excitation port.

Work Plane 1 (wp1)

- 1 In the **Geometry** toolbar, click  **Work Plane**.
- 2 In the **Settings** window for **Work Plane**, locate the **Plane Definition** section.
- 3 From the **Plane** list, choose **yz-plane**.

4 Click  **Show Work Plane**.

Work Plane 1 (wp1)>Plane Geometry

- 1 Click the  **Zoom Extents** button in the **Graphics** toolbar.
- 2 Click the  **Zoom In** button in the **Graphics** toolbar.



Work Plane 1 (wp1)>Rectangle 1 (r1)

- 1 In the **Work Plane** toolbar, click  **Rectangle**.
- 2 In the **Settings** window for **Rectangle**, locate the **Size and Shape** section.
- 3 In the **Width** text field, type $5e-3$.
- 4 In the **Height** text field, type $15e-3$.
- 5 Locate the **Position** section. In the **xw** text field, type -0.05 .
- 6 In the **yw** text field, type -0.0175 .

Work Plane 1 (wp1)>Rectangle 2 (r2)

- 1 In the **Work Plane** toolbar, click  **Rectangle**.
- 2 In the **Settings** window for **Rectangle**, locate the **Size and Shape** section.
- 3 In the **Width** text field, type $5e-3$.
- 4 In the **Height** text field, type $15e-3$.
- 5 Locate the **Position** section. In the **xw** text field, type -0.03 .
- 6 In the **yw** text field, type -0.0175 .

Work Plane 1 (wp1)>Rectangle 3 (r3)

- 1 In the **Work Plane** toolbar, click  **Rectangle**.
- 2 In the **Settings** window for **Rectangle**, locate the **Size and Shape** section.
- 3 In the **Width** text field, type $15e-3$.
- 4 In the **Height** text field, type $5e-3$.
- 5 Locate the **Position** section. In the **xw** text field, type -0.045 .
- 6 In the **yw** text field, type -0.0175 .
- 7 In the **Work Plane** toolbar, click  **Build All**.

Form Union (fin)

In the **Home** toolbar, click  **Build All**.



DEFINITIONS

The driven version of the model will use an impedance boundary condition to take into account the conduction losses in the coil. Define a selection to facilitate this process.

Coil Surface

- 1 In the **Definitions** toolbar, click  **Explicit**.
- 2 In the **Settings** window for **Explicit**, type Coil Surface in the **Label** text field.
- 3 Select Domain 6 only.
Domain 6 is the coil.
- 4 Locate the **Output Entities** section. From the **Output entities** list, choose **Adjacent boundaries**.

ADD MATERIAL

- 1 In the **Home** toolbar, click  **Add Material** to open the **Add Material** window.
- 2 Go to the **Add Material** window.
- 3 In the tree, select **Built-in>Copper**.
- 4 Click **Add to Component** in the window toolbar.
- 5 In the **Home** toolbar, click  **Add Material** to close the **Add Material** window.

MATERIALS

Copper (mat2)

- 1 In the **Settings** window for **Material**, locate the **Geometric Entity Selection** section.
- 2 From the **Geometric entity level** list, choose **Boundary**.
- 3 From the **Selection** list, choose **Coil Surface**.

ELECTROMAGNETIC WAVES, FREQUENCY DOMAIN (EMW)

Impedance Boundary Condition 1



- 1 In the **Physics** toolbar, click  **Boundaries** and choose **Impedance Boundary Condition**.
- 2 In the **Settings** window for **Impedance Boundary Condition**, locate the **Boundary Selection** section.
- 3 From the **Selection** list, choose **Coil Surface**.
- 4 In the **Model Builder** window, click **Electromagnetic Waves, Frequency Domain (emw)**.
- 5 In the **Settings** window for **Electromagnetic Waves, Frequency Domain**, locate the **Domain Selection** section.
- 6 From the **Selection** list, choose **All domains**.
- 7 Select Domains 1–5 and 7–10 only.

While the Perfect Electric Conductor condition is the default on exterior boundaries, you need to apply it manually should you need it on interior ones.

Perfect Electric Conductor 2

- 1 In the **Physics** toolbar, click  **Boundaries** and choose **Perfect Electric Conductor**.
- 2 Select Boundaries 30 and 37 only.
Boundaries 30 and 37 are those connecting the port with the coil.

Lumped Port 1

- 1 In the **Physics** toolbar, click  **Boundaries** and choose **Lumped Port**.
- 2 Select Boundary 33 only.
Boundary 33 connects the two perfect electric conductors you just defined.
For the first port, wave excitation is **on** by default.
- 3 In the **Settings** window for **Lumped Port**, locate the **Boundary Selection** section.
- 4 Click  **Create Selection**.
Create a set of selections for use in the study settings.
- 5 In the **Create Selection** dialog box, type Lumped port 1 in the **Selection name** text field.
- 6 Click **OK**.

DEFINITIONS

Perfectly Matched Layer 1 (pml1)

- 1 In the **Definitions** toolbar, click  **Perfectly Matched Layer**.
- 2 Select Domains 1–4 and 7–10 only.
- 3 In the **Settings** window for **Perfectly Matched Layer**, locate the **Geometry** section.
- 4 From the **Type** list, choose **Spherical**.

MESH 1

When setting up the mesh for the driven problem, make sure to get a fine mesh on the port boundary. The PML performs at its best when it is meshed with a swept mesh.

Size

- 1 In the **Model Builder** window, under **Component 1 (comp1)>Mesh 1** click **Size**.
- 2 In the **Settings** window for **Size**, locate the **Element Size** section.
- 3 Click the **Custom** button.
- 4 Locate the **Element Size Parameters** section. In the **Minimum element size** text field, type 0.003.

Free Tetrahedral 1

- 1 In the **Model Builder** window, click **Free Tetrahedral 1**.
- 2 In the **Settings** window for **Free Tetrahedral**, locate the **Domain Selection** section.
- 3 From the **Geometric entity level** list, choose **Domain**.
- 4 Select Domains 5 and 6 only.
Domain 5 is the coil and Domain 6 the surrounding air domain.

Size 1

- 1 In the **Model Builder** window, click **Size 1**.
- 2 Select Domain 6 only.

Size 2

- 1 In the **Model Builder** window, right-click **Free Tetrahedral 1** and choose **Size**.
- 2 In the **Settings** window for **Size**, locate the **Geometric Entity Selection** section.
- 3 From the **Geometric entity level** list, choose **Boundary**.
- 4 Select Boundary 33 only.
Boundary 33 is the port boundary.
- 5 Locate the **Element Size** section. From the **Predefined** list, choose **Finer**.
- 6 Click the **Custom** button.
- 7 Locate the **Element Size Parameters** section.
- 8 Select the **Maximum element size** check box. In the associated text field, type 0.003.

Swept 1

In the **Mesh** toolbar, click  **Swept**.

Distribution 1

- 1 Right-click **Swept 1** and choose **Distribution**.
The default 5 elements is a sufficient number to have across the PML.
- 2 Right-click **Distribution 1** and choose **Build All**.

DEFINITIONS

Hide for Physics 1

- 1 In the **Model Builder** window, right-click **View 1** and choose **Hide for Physics**.
- 2 Select Domain 2 only.
Domain 2 is the PML domain straight in front of you if you are in the default coordinate system view, but any one of the outer domains will do.

Hide for Physics 2

- 1 Right-click **View 1** and choose **Hide for Physics**.
- 2 In the **Settings** window for **Hide for Physics**, locate the **Geometric Entity Selection** section.
- 3 From the **Geometric entity level** list, choose **Boundary**.
- 4 Select Boundary 10 only.

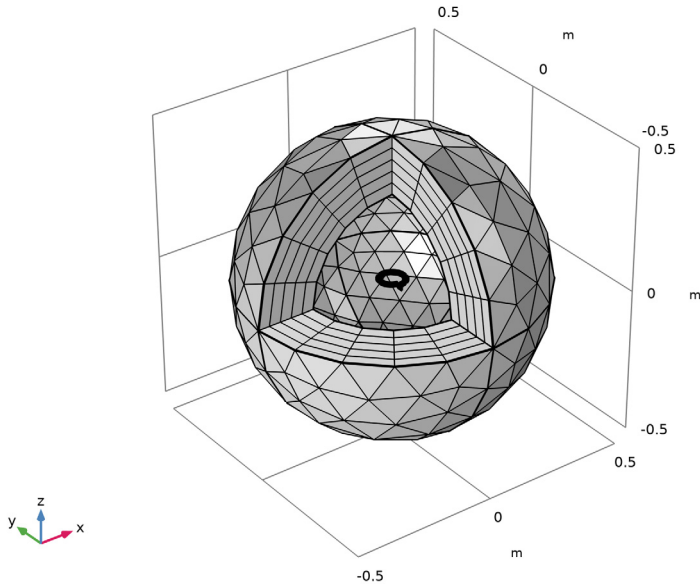

MESH 1



Compare the meshed structure with the above figure.

- 1 Click the  **Reset Hiding** button in the **Graphics** toolbar.

ADD STUDY

- 1 In the **Home** toolbar, click  **Add Study** to open the **Add Study** window.
- 2 Go to the **Add Study** window.
- 3 Find the **Studies** subsection. In the **Select Study** tree, select **Preset Studies for Selected Physics Interfaces>Adaptive Frequency Sweep**.
- 4 Click **Add Study** in the window toolbar.
- 5 In the **Home** toolbar, click  **Add Study** to close the **Add Study** window.

STUDY 2

Step 1: Adaptive Frequency Sweep

- 1 In the **Settings** window for **Adaptive Frequency Sweep**, locate the **Study Settings** section.
- 2 In the **Frequencies** text field, type `range(173[MHz],0.01[MHz],175.2[MHz])`.
This gives you a range of frequencies starting at 173 MHz and ending at 175.2 MHz, with a solution at every 0.01 MHz.
- 3 From the **AWE expression type** list, choose **User controlled**.
- 4 In the table, enter the following settings:

Asymptotic waveform evaluation (AWE) expressions

`abs(comp1.emw.Zport_1)`

A slowly varying scalar value curve works well for AWE expressions. Use `abs(comp1.emw.Zport_1)` for this coil model.

Because such a fine frequency step generates a memory-intensive solution, the model file size will increase tremendously when it is saved. When only the frequency response of port related variables are of interest, it is not necessary to store all of the field solutions. By selecting the **Store fields in output** check box in the **Values of Dependent Variables** section, we can control the part of the model on which the computed solution is saved. We only add the selection containing these boundaries where the port variables are calculated. The lumped port size is typically very small compared to the entire modeling domain, and the saved file size with the fine frequency step is more or less that of the regular discrete frequency sweep model when only the solutions on the port boundaries are stored.

- 5 Locate the **Values of Dependent Variables** section. Find the **Store fields in output** subsection. From the **Settings** list, choose **For selections**.
- 6 Under **Selections**, click **+ Add**.
- 7 In the **Add** dialog box, select **Lumped port 1** in the **Selections** list.
- 8 Click **OK**.
- 9 In the **Home** toolbar, click **= Compute**.

RESULTS

Electric Field (emw) 1

Since the results are stored only on the lumped port boundaries, this default E-field norm plot does not provide useful information.

1 Right-click **Results>Electric Field (emw) 1** and choose **Delete**.

Set up a 1D plot group to plot the port impedance versus the frequency.

1D Plot Group 5

1 In the **Home** toolbar, click  **Add Plot Group** and choose **1D Plot Group**.

2 In the **Settings** window for **1D Plot Group**, locate the **Data** section.

3 From the **Dataset** list, choose **Study 2/Solution 2 (sol2)**.

4 Click to expand the **Title** section. From the **Title type** list, choose **Manual**.

5 In the **Title** text area, type Lumped Port Impedance ([Omega]).

6 Locate the **Legend** section. Clear the **Show legends** check box.

Global 1

1 Right-click **1D Plot Group 5** and choose **Global**.

2 In the **Settings** window for **Global**, locate the **y-Axis Data** section.

3 In the table, enter the following settings:

Expression	Unit	Description
abs(emw.Zport_1)	Ω	

4 Locate the **x-Axis Data** section. From the **Parameter** list, choose **Expression**.

5 In the **Expression** text field, type freq.

6 From the **Unit** list, choose **MHz**.

7 In the **1D Plot Group 5** toolbar, click  **Plot**.

The impedance peak indicates that the driven problem has its resonance shifted slightly down, to approximately 174 MHz. Compare the reproduced plot with that in [Figure 4](#), from which you can evaluate the Q factor.

