



Computing the Radar Cross Section of a Perfectly Conducting Sphere

General Description

This classic benchmark problem in computational electromagnetics is about computing the monostatic *radar cross section* (RCS) of a perfectly conducting sphere in free space, illuminated by a linearly polarized plane wave. The RCS is computed for sphere radius to free space wavelength ratios ranging from 0.1 to 0.8 and is compared to an exact analytical solution. This region represents the lower half of a transition zone between a long wavelength asymptotic solution, “Rayleigh scattering,” and a short wavelength asymptotic solution, “Geometrical Optics.” The transition zone is known as the “Mie region” after the originator of the exact solution. A mesh convergence study is performed for the first scattering resonance at a sphere radius to free space wavelength ratio of approximately 0.16364.

Model Setup

GEOMETRY

Due to symmetry, it is sufficient to model only one quarter of the sphere. [Figure 1](#) shows the geometry and boundary conditions.

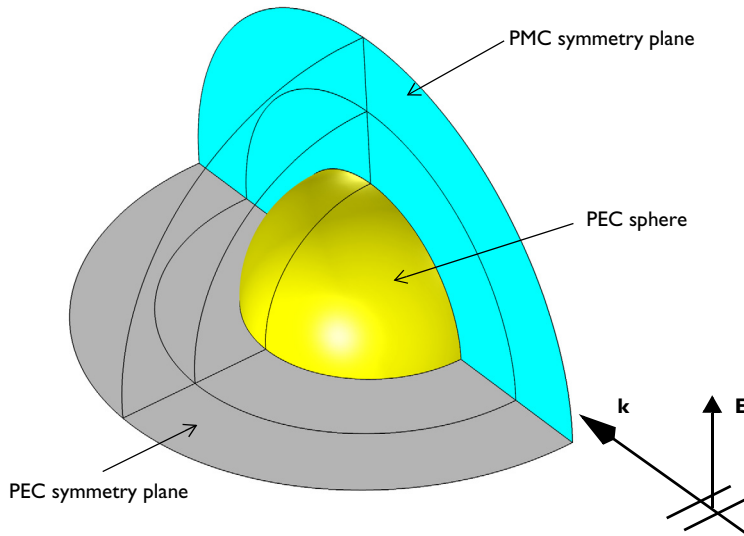

Figure 1: The computational domain for computing the RCS of a PEC sphere in free space. Due to symmetry, it is sufficient to model one quarter of the sphere.

The geometry consists of two concentric spherical shells. The innermost shell, adjacent to the sphere, represents the free space domain, and the second shell represents a perfectly matched layer (PML) region that is used to provide an approximately reflection free termination of the, in reality unbounded, free space domain.

EQUATION

The model is set up and solved using a frequency domain formulation for the scattered electric field. The incident plane wave travels in the positive x direction, with the electric field polarized along the z -axis. The governing frequency domain equation can be written in the form

$$\nabla \times (\mu_r^{-1} \nabla \times (\mathbf{E}_i + \mathbf{E}_{sc})) - k_0^2 \epsilon_{rc} (\mathbf{E}_i + \mathbf{E}_{sc}) = \mathbf{0}$$

where the scattered electric field \mathbf{E}_{sc} is the dependent variable and the incident electric field $\mathbf{E}_i = (0, 0, E_z)$, with

$$E_z = 1[V/m]e^{-jk_0x}$$

The equation is discretized using second order edge elements (also known as vector elements, Nedelec elements, or curl-conforming elements). It is well known that in order to resolve the wave field, one should strive for 10 or more discretization points per wavelength. The combination of using second-order elements and 8 elements per wavelength fulfills this criterion with some margin. To respect the geometry, a mesh that is somewhat finer for the longest wavelengths is required on the surface of the scatterer. A maximum element size of half the radius is used on those boundaries. The PML region requires special meshing as described under the section [Perfectly Matched Layer](#) below.

BOUNDARY CONDITIONS

The sphere has perfect electric conductor (PEC) boundaries. The PEC boundary condition

$$\mathbf{n} \times \mathbf{E} = \mathbf{0}$$

sets the tangential component of the electric field to zero. It is used for the modeling of lossless metallic surfaces or as a symmetry type boundary condition. It imposes symmetry for magnetic fields and “magnetic currents” and antisymmetry for electric fields and electric currents.

PEC boundary conditions and perfect magnetic conductor (PMC) boundary conditions apply on the symmetry planes used to subdivide the sphere model.

The PMC boundary condition

$$\mathbf{n} \times \mathbf{H} = \mathbf{0}$$

sets the tangential component of the magnetic field and thus also the surface current density to zero. On external boundaries, this can be interpreted as a “high surface impedance” boundary condition or used as a symmetry type boundary condition. It imposes symmetry for electric fields and electric currents and antisymmetry for magnetic fields and “magnetic currents.”

PERFECTLY MATCHED LAYER

The PML region, the second concentric shell around the sphere, provides an approximately reflection free termination of the computational domain by applying a complex-valued coordinate stretching in the radial (outward) direction. For good accuracy, there should be at least five elements through the thickness of the PML. This condition is usually most efficiently met by using a swept mesh so that the effective element quality becomes insensitive to the scaling in the radial direction. The mesh used in this example is shown in [Figure 2](#). It consists of a free tetrahedral mesh around the sphere and a swept mesh in the PML domain.

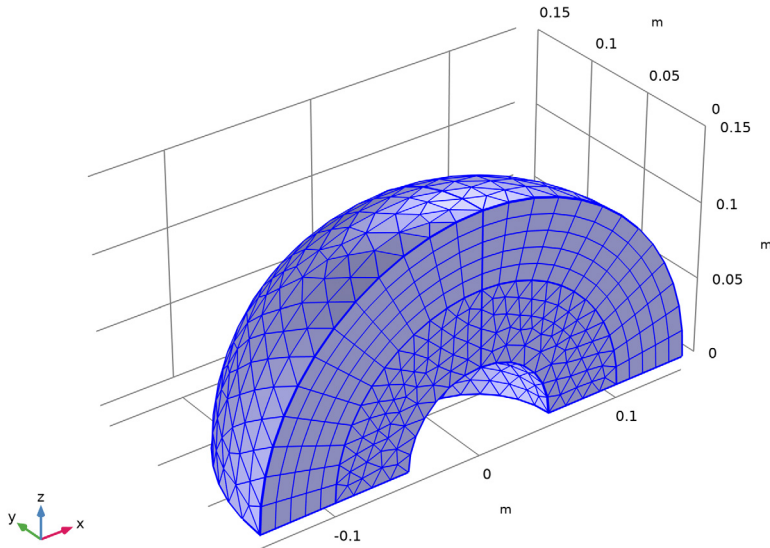

Figure 2: A free tetrahedral mesh is used in the free-space region around the sphere, and a swept mesh is used in the PML region.

The free space region around the sphere is defined to be the far-field domain. This specifies that a near-field to far-field calculation is done on the boundary of this domain, which takes the computed electric fields around the sphere and uses the Stratton-Chu equation to find the scattered electric field infinitely far away from the origin.

In 3D, this is:

$$\mathbf{E}_p = \frac{jk}{4\pi} \mathbf{r}_0 \times \int [\mathbf{n} \times \mathbf{E} - \eta \mathbf{r}_0 \times (\mathbf{n} \times \mathbf{H})] \exp(jk \mathbf{r} \cdot \mathbf{r}_0) dS$$

For scattering problems, the far field in COMSOL is identical to what in physics is known as the “scattering amplitude.”

The radiating or scattering object is located in the vicinity of the origin, while the far-field point p is taken at infinity but with a well-defined angular position (θ, φ) .

In the above formulas,

- \mathbf{E} and \mathbf{H} are the fields on the “aperture” — the surface S enclosing the sphere.
- \mathbf{r}_0 is the unit vector pointing from the origin to the field point p . If the field points lie on a spherical surface S' , \mathbf{r}_0 is the unit normal to S' .
- \mathbf{n} is the unit normal to the surface S .
- η is the wave impedance:

$$\eta = \sqrt{\mu/\epsilon}$$

- k is the wave number.
- λ is the wavelength.
- \mathbf{r} is the radius vector (not a unit vector) of the surface S .
- \mathbf{E}_p is the calculated far field in the direction from the origin toward point p .

The unit vector \mathbf{r}_0 can be interpreted as the direction defined by the angular position (θ, φ) and \mathbf{E}_p is the far field in this direction.

Results and Discussion

Figure 3 compares the simulation result for the RCS with the analytic solution computed using the scattered component of the electric field from this example and equation 11-247 in Ref. 1. As the figure shows, there is good agreement between the analytic solution determined in this manner and the finite-element model.

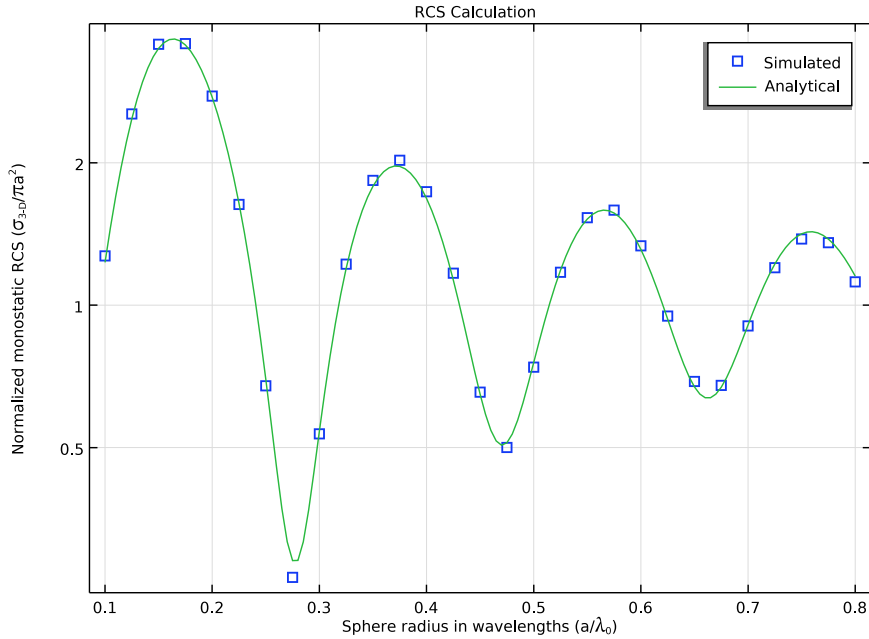

Figure 3: Comparison of the analytic solution and the COMSOL Multiphysics model of the RCS of a PEC sphere in free space.

Mesh Convergence

For the wavelength corresponding to the first maximum in the RCS plot in Figure 3, a mesh convergence study is performed to validate that the model converges toward a unique solution when refining the mesh isotropically. The model is solved in a parametric sweep over the number of mesh elements per wavelength. In the PML, the mesh density is not changed in the radial outward direction (that is, in the sweep direction for the swept mesh). The PML is resolved by 5 element layers in this direction which is sufficient to resolve the exponential damping in the radial direction. Thus the error contribution from the PML is not expected to decrease by adding more element layers. The main error contribution from the PML is due to the fact that it is not perfectly absorbing because of finite thickness and damping rather than mesh density. Thus, it is expected to give a contribution to the error in the computed RCS that does not decrease when refining the mesh.

Figure 4 shows the mesh convergence. The displayed error is the difference between the RCS from the finite element model and the exact solution from equation 11-247 in Ref. 1. As mentioned, the PML is expected to yield an error contribution which cannot be eliminated by refining the mesh. As there is no sign of stagnation in the convergence plot, this error contribution must be smaller than 0.1%. The RCS plot in Figure 3 corresponds to 8 elements per wavelength, that is a relative error of about 3% at the wavelength of the maximum in the RCS versus wavelength curve.

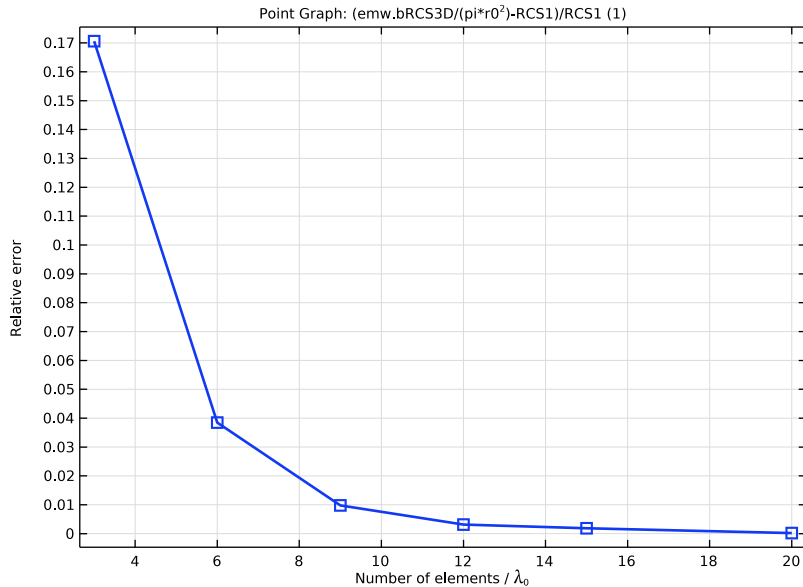

Figure 4: Mesh convergence for the difference in backscattering (monostatic) RCS between the COMSOL model and the exact solution.

Reference

1. C.A. Balanis, *Advanced Engineering Electromagnetics*, John Wiley & Sons, 1989.

Application Library path: RF_Module/Verification_Examples/rcs_sphere



Modeling Instructions

From the **File** menu, choose **New**.

NEW

In the **New** window, click  **Model Wizard**.

MODEL WIZARD

- 1 In the **Model Wizard** window, click .
- 2 In the **Select Physics** tree, select **Radio Frequency>Electromagnetic Waves, Frequency Domain (emw)**.
- 3 Click **Add**.
- 4 Click  **Study**.
- 5 In the **Select Study** tree, select **General Studies>Frequency Domain**.
- 6 Click  **Done**.

GLOBAL DEFINITIONS

Parameters 1

- 1 In the **Model Builder** window, under **Global Definitions** click **Parameters 1**.
- 2 In the **Settings** window for **Parameters**, locate the **Parameters** section.
- 3 In the table, enter the following settings:

Name	Expression	Value	Description
r_lda	0.5	0.5	Sphere radius in wavelengths
r0	5[cm]	0.05 m	Sphere radius
lda	r0/r_lda	0.1 m	Wavelength
k0	2*pi/lda	62.832 1/m	Wavenumber
f0	c_const/lda	2.9979E9 1/s	Frequency
t_air	lda/2	0.05 m	Thickness of air around sphere
t_pml	lda/2	0.05 m	Thickness of PML
h_size	8	8	Number of elements per wavelength
E0	1[V/m]	1 V/m	Incident field magnitude
rho	2*pi*r_lda	3.1416	Sphere circumference in wavelengths

DEFINITIONS

To compute the RCS using the analytical expression, the spherical Bessel functions of the first and second kinds and the spherical Hankel function of the second kind need to be defined. One **Variables** node will be created for each function to avoid clustering all the variables in a single **Variables** node. For the frequency range of interest in this model, we truncate the summation in the analytical expression of the RCS at $n=7$.

Spherical Bessel Function of the First Kind

1 In the **Model Builder** window, expand the **Component 1 (comp1)>Definitions** node.

2 Right-click **Definitions** and choose **Variables**.

3 In the **Settings** window for **Variables**, type Spherical Bessel Function of the First Kind in the **Label** text field.

4 Locate the **Variables** section. In the table, enter the following settings:

Name	Expression	Unit	Description
sbesselj1	$\sqrt{\pi/(2\rho)} * \text{besselj}(1.5, \rho)$		Order 1
sbesselj2	$\sqrt{\pi/(2\rho)} * \text{besselj}(2.5, \rho)$		Order 2
sbesselj3	$\sqrt{\pi/(2\rho)} * \text{besselj}(3.5, \rho)$		Order 3
sbesselj4	$\sqrt{\pi/(2\rho)} * \text{besselj}(4.5, \rho)$		Order 4
sbesselj5	$\sqrt{\pi/(2\rho)} * \text{besselj}(5.5, \rho)$		Order 5
sbesselj6	$\sqrt{\pi/(2\rho)} * \text{besselj}(6.5, \rho)$		Order 6
sbesselj7	$\sqrt{\pi/(2\rho)} * \text{besselj}(7.5, \rho)$		Order 7

Spherical Bessel Function of the Second Kind

1 Right-click **Definitions** and choose **Variables**.

2 In the **Settings** window for **Variables**, type Spherical Bessel Function of the Second Kind in the **Label** text field.

3 Locate the **Variables** section. In the table, enter the following settings:

Name	Expression	Unit	Description
sbessely1	$\sqrt{\pi / (2 \cdot \rho)} \cdot \text{bessely}(1.5, \rho)$		Order 1
sbessely2	$\sqrt{\pi / (2 \cdot \rho)} \cdot \text{bessely}(2.5, \rho)$		Order 2
sbessely3	$\sqrt{\pi / (2 \cdot \rho)} \cdot \text{bessely}(3.5, \rho)$		Order 3
sbessely4	$\sqrt{\pi / (2 \cdot \rho)} \cdot \text{bessely}(4.5, \rho)$		Order 4
sbessely5	$\sqrt{\pi / (2 \cdot \rho)} \cdot \text{bessely}(5.5, \rho)$		Order 5
sbessely6	$\sqrt{\pi / (2 \cdot \rho)} \cdot \text{bessely}(6.5, \rho)$		Order 6
sbessely7	$\sqrt{\pi / (2 \cdot \rho)} \cdot \text{bessely}(7.5, \rho)$		Order 7

Spherical Hankel Function of the Second Kind

1 Right-click **Definitions** and choose **Variables**.

2 In the **Settings** window for **Variables**, type Spherical Hankel Function of the Second Kind in the **Label** text field.

3 Locate the **Variables** section. In the table, enter the following settings:

Name	Expression	Unit	Description
shankel1	$\text{sbesselj}1 + 1j \cdot \text{sbessely}1$		Order 1
shankel2	$\text{sbesselj}2 + 1j \cdot \text{sbessely}2$		Order 2
shankel3	$\text{sbesselj}3 + 1j \cdot \text{sbessely}3$		Order 3
shankel4	$\text{sbesselj}4 + 1j \cdot \text{sbessely}4$		Order 4
shankel5	$\text{sbesselj}5 + 1j \cdot \text{sbessely}5$		Order 5
shankel6	$\text{sbesselj}6 + 1j \cdot \text{sbessely}6$		Order 6
shankel7	$\text{sbesselj}7 + 1j \cdot \text{sbessely}7$		Order 7

Coefficient a

1 Right-click **Definitions** and choose **Variables**.

2 In the **Settings** window for **Variables**, type Coefficient a in the **Label** text field.

3 Locate the **Variables** section. In the table, enter the following settings:

Name	Expression	Unit	Description
a1	sbesselj1/shanke11		
a2	sbesselj2/shanke12		
a3	sbesselj3/shanke13		
a4	sbesselj4/shanke14		
a5	sbesselj5/shanke15		
a6	sbesselj6/shanke16		
a7	sbesselj7/shanke17		

Computing the coefficient b requires taking the derivative with respect to ρ . This can be done conveniently by using the built-in $d(f, x)$ operator.

Coefficient b

1 Right-click **Definitions** and choose **Variables**.

2 In the **Settings** window for **Variables**, type Coefficient b in the **Label** text field.

3 Locate the **Variables** section. In the table, enter the following settings:

Name	Expression	Unit	Description
b1	$-d(\rho * sbesselj1, \rho) / d(\rho * shanke11, \rho)$		
b2	$-d(\rho * sbesselj2, \rho) / d(\rho * shanke12, \rho)$		
b3	$-d(\rho * sbesselj3, \rho) / d(\rho * shanke13, \rho)$		
b4	$-d(\rho * sbesselj4, \rho) / d(\rho * shanke14, \rho)$		
b5	$-d(\rho * sbesselj5, \rho) / d(\rho * shanke15, \rho)$		
b6	$-d(\rho * sbesselj6, \rho) / d(\rho * shanke16, \rho)$		
b7	$-d(\rho * sbesselj7, \rho) / d(\rho * shanke17, \rho)$		

Analytical Expression of the RCS

1 Right-click **Definitions** and choose **Variables**.

2 In the **Settings** window for **Variables**, type Analytical Expression of the RCS in the **Label** text field.

3 Locate the **Variables** section. In the table, enter the following settings:

Name	Expression	Unit	Description
RCS_analytical	$1 / (\rho)^2 \cdot \text{abs}(-3 \cdot (a1+b1)+5 \cdot (a2+b2) - 7 \cdot (a3+b3)+9 \cdot (a4+b4) - 11 \cdot (a5+b5)+13 \cdot (a6+b6) - 15 \cdot (a7+b7)) ^2$		Analytically calculated RCS

With the calculated coefficients, the RCS can be evaluated according to the analytical expression.

GEOMETRY I

First, create a sphere with two layer definitions. The outermost layer represents the PMLs and the core represents the PEC sphere for RCS analysis. The median layer is the air domain.

Sphere 1 (sph1)

- 1 In the **Geometry** toolbar, click  **Sphere**.
- 2 In the **Settings** window for **Sphere**, locate the **Size** section.
- 3 In the **Radius** text field, type $r0+t_air+t_pml$.
- 4 Click to expand the **Layers** section. In the table, enter the following settings:

Layer name	Thickness (m)
Layer 1	t_pml
Layer 2	t_air

- 5 Click  **Build All Objects**.

DEFINITIONS

Add a view with a different angle of perspective.



View 2

In the **Model Builder** window, under **Component 1 (comp1)** right-click **Definitions** and choose **View**.

Camera

Change only the sign of y in the Position and Up Vector sections:

- 1 In the **Model Builder** window, expand the **View 2** node, then click **Camera**.
- 2 In the **Settings** window for **Camera**, locate the **Position** section.

- 3 In the **y** text field, type 1.871.
- 4 Locate the **Up Vector** section. In the **y** text field, type -0.412.
- 5 Click  **Update**.
Choose wireframe rendering to get a better view of the interior parts.
- 6 Click the  **Wireframe Rendering** button in the **Graphics** toolbar.

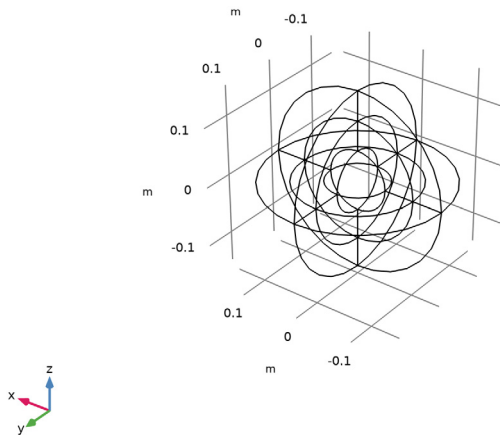

GEOMETRY I

Due to the symmetry of the structure, it is sufficient to model only one quarter of the sphere. Delete the domains which are not part of the modeling domain.

Delete Entities I (del)

- 1 In the **Model Builder** window, under **Component 1 (comp1)** right-click **Geometry I** and choose **Delete Entities**.
- 2 In the **Settings** window for **Delete Entities**, locate the **Entities or Objects to Delete** section.
- 3 From the **Geometric entity level** list, choose **Domain**.

4 On the object **sph1**, select Domains 1–3, 5–7, and 9–15 only.

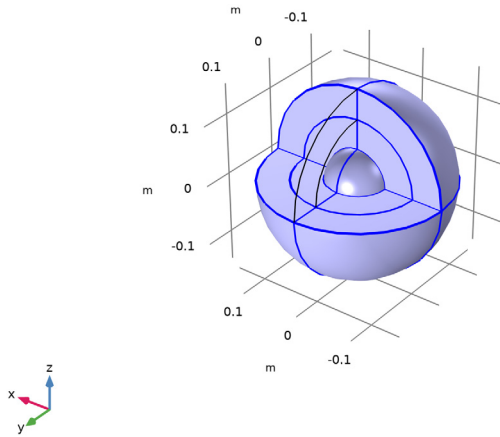

5 Click  **Build All Objects**.

DEFINITIONS

View 1

After removing unnecessary domains, change the view to the first view definition which gives a better angle showing all layers.

1 Click the  **Zoom Extents** button in the **Graphics** toolbar.

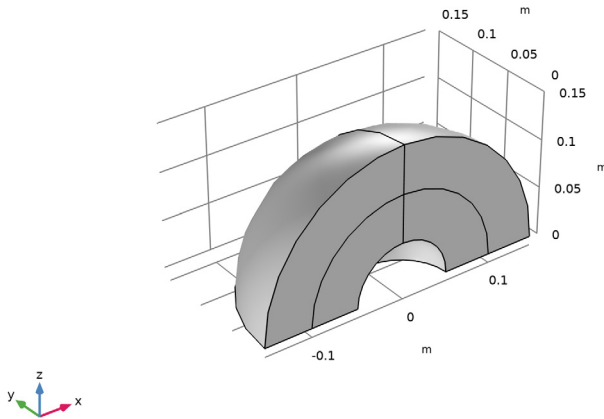

This is the modeling domain for RCS analysis.

ELECTROMAGNETIC WAVES, FREQUENCY DOMAIN (EMW)

Now set up the physics. You will solve the model for the scattered field, which requires background electric field (E-field) information. The background plane wave is traveling in the positive x direction, with the electric field polarized along the z -axis. The default boundary condition is perfect electric conductor, which applies to all exterior boundaries including the boundaries perpendicular to the background E-field polarization.

- 1 In the **Model Builder** window, under **Component 1 (comp1)** click **Electromagnetic Waves, Frequency Domain (emw)**.
- 2 In the **Settings** window for **Electromagnetic Waves, Frequency Domain**, locate the **Formulation** section.
- 3 From the list, choose **Scattered field**.

4 Specify the \mathbf{E}_b vector as

0	x
0	y
$E_0 \exp(-j \cdot k_0 \cdot x)$	z

Choose wireframe rendering in the current view to get a better view of the interior parts.

5 Click the  **Wireframe Rendering** button in the **Graphics** toolbar.

Scattering Boundary Condition 1

1 In the **Physics** toolbar, click  **Boundaries** and choose **Scattering Boundary Condition**.

2 Select Boundaries 3 and 14 only.

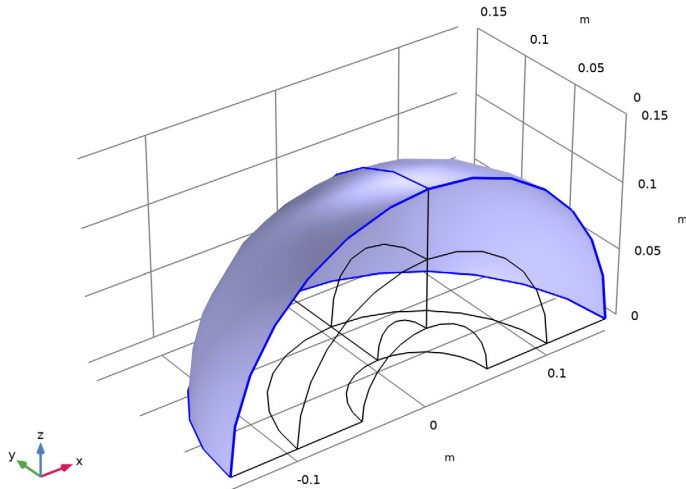

DEFINITIONS

The outermost domains from the center of the sphere are the PMLs.

Perfectly Matched Layer 1 (pml1)

1 In the **Definitions** toolbar, click  **Perfectly Matched Layer**.

2 Select Domains 1 and 4 only.

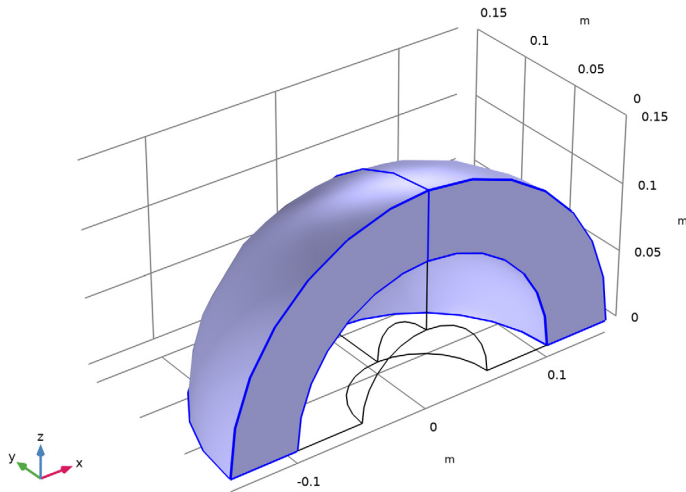

3 In the **Settings** window for **Perfectly Matched Layer**, locate the **Geometry** section.

4 From the **Type** list, choose **Spherical**.

ELECTROMAGNETIC WAVES, FREQUENCY DOMAIN (EMW)

Set PMC on the boundaries parallel to the background E-field polarization.

Perfect Magnetic Conductor 1

1 In the **Physics** toolbar, click  **Boundaries** and choose **Perfect Magnetic Conductor**.

2 Select Boundaries 1, 4, 9, and 12 only.

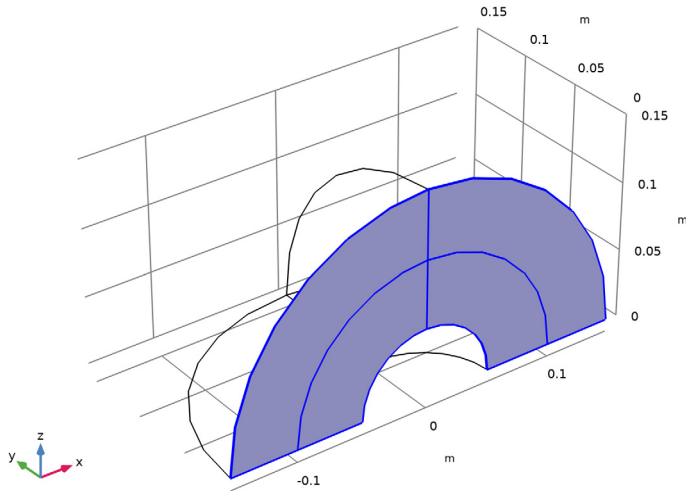

Far-Field Domain 1

In the **Physics** toolbar, click  **Domains** and choose **Far-Field Domain**.



Far-Field Calculation 1

- 1 In the **Model Builder** window, expand the **Far-Field Domain 1** node, then click **Far-Field Calculation 1**.
- 2 In the **Settings** window for **Far-Field Calculation**, locate the **Far-Field Calculation** section.
- 3 Select the **Symmetry in the $y=0$ plane** check box.
- 4 Select the **Symmetry in the $z=0$ plane** check box.
- 5 From the **Symmetry type** list, choose **Symmetry in H (PEC)**.

MATERIALS

Next, assign material properties. Use air for all domains.

ADD MATERIAL

- 1 In the **Home** toolbar, click  **Add Material** to open the **Add Material** window.
- 2 Go to the **Add Material** window.
- 3 In the tree, select **Built-in>Air**.
- 4 Click **Add to Component** in the window toolbar.
- 5 In the **Home** toolbar, click  **Add Material** to close the **Add Material** window.

MESH 1

Use a tetrahedral mesh for the air domains.

Free Tetrahedral 1

- 1 In the **Mesh** toolbar, click  **Free Tetrahedral**.
- 2 In the **Settings** window for **Free Tetrahedral**, locate the **Domain Selection** section.
- 3 From the **Geometric entity level** list, choose **Domain**.
- 4 Select Domains 2 and 3 only.

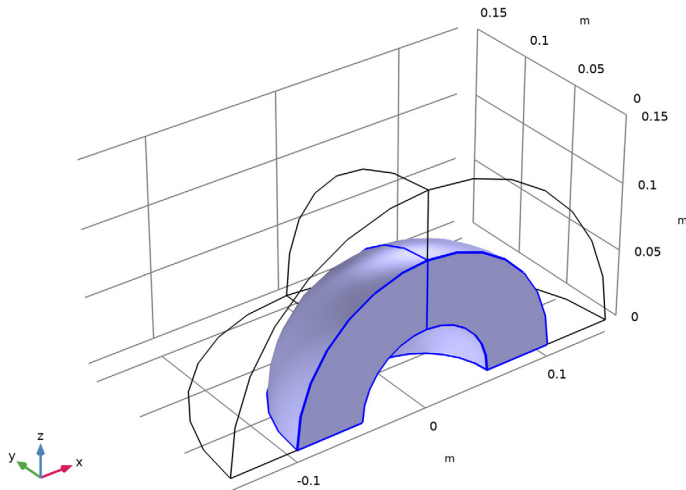

The maximum mesh size is at most 0.2 wavelengths in free space. In this model, use 0.125 wavelengths.

Size

- 1 In the **Model Builder** window, click **Size**.
- 2 In the **Settings** window for **Size**, locate the **Element Size** section.
- 3 Click the **Custom** button.
- 4 Locate the **Element Size Parameters** section. In the **Maximum element size** text field, type $1da/h_size$.
- 5 In the **Minimum element size** text field, type $1da/h_size$.

Use a swept mesh for the PML domains.

Swept 1

In the **Mesh** toolbar, click  **Swept**.

Distribution 1

- 1 Right-click **Swept 1** and choose **Distribution**.
- 2 Right-click **Distribution 1** and choose **Build All**.

Compare the mesh with that shown in [Figure 2](#).

STUDY 1

Parametric Sweep

- 1 In the **Study** toolbar, click  **Parametric Sweep**.
- 2 In the **Settings** window for **Parametric Sweep**, locate the **Study Settings** section.
- 3 Click **+ Add**.
- 4 In the table, enter the following settings:

Parameter name	Parameter value list	Parameter unit
r_1da (Sphere radius in wavelengths)	range (0.1, 0.025, 0.8)	

Step 1: Frequency Domain

- 1 In the **Model Builder** window, click **Step 1: Frequency Domain**.
- 2 In the **Settings** window for **Frequency Domain**, locate the **Study Settings** section.
- 3 In the **Frequencies** text field, type f_0 .
- 4 In the **Model Builder** window, click **Study 1**.
- 5 In the **Settings** window for **Study**, locate the **Study Settings** section.
- 6 Clear the **Generate default plots** check box.
- 7 In the **Study** toolbar, click  **Compute**.

RESULTS

Global Evaluation Sweep 1

- 1 In the **Model Builder** window, expand the **Results** node.
- 2 Right-click **Results>Derived Values** and choose **More Derived Values>Global Evaluation Sweep**.

By default, the analytically calculated RCS variable will be evaluated at the simulated frequencies. However, a finer frequency resolution can be achieved without actually running the simulation by utilizing a **Global Evaluation Sweep**, where the parameter ρ

is swept at a much finer spacing. This way, the analytically calculated RCS will show a smooth curve.

3 In the **Settings** window for **Global Evaluation Sweep**, locate the **Parameters** section.

4 In the table, enter the following settings:

Parameter name	Parameter value list
r_lda	range(0.1,0.005,0.8)

5 Locate the **Expressions** section. In the table, enter the following settings:

Expression	Unit	Description
RCS_analytical		Analytically calculated RCS

6 Click  **Evaluate**.

Follow the instructions below to reproduce the plot in [Figure 3](#). First, show the computed RCS values using square markers.

ID Plot Group 1

1 In the **Results** toolbar, click  **ID Plot Group**.

2 In the **Settings** window for **ID Plot Group**, locate the **Data** section.

3 From the **Dataset** list, choose **Study 1/Parametric Solutions 1 (sol2)**.

4 Click to expand the **Title** section. From the **Title type** list, choose **Custom**.

5 Find the **Type and data** subsection. Clear the **Unit** check box.

6 Clear the **Description** check box.

7 Clear the **Type** check box.

8 Find the **User** subsection. In the **Prefix** text field, type RCS Calculation.

9 Locate the **Plot Settings** section.

10 Select the **x-axis label** check box. In the associated text field, type Sphere radius in wavelengths (a/λ).

11 Select the **y-axis label** check box. In the associated text field, type Normalized monostatic RCS ($\sigma_{3-D}/\pi a^2$).

12 Locate the **Axis** section. Select the **y-axis log scale** check box.

Point Graph 1

1 Right-click **ID Plot Group 1** and choose **Point Graph**.

2 Select Point 2 only.

3 In the **Settings** window for **Point Graph**, locate the **y-Axis Data** section.

- 4 In the **Expression** text field, type $\text{emw.bRCS3D}/(\pi*r0^2)$.
- 5 Locate the **x-Axis Data** section. From the **Axis source data** list, choose **Outer solutions**.
- 6 Click to expand the **Coloring and Style** section. Find the **Line style** subsection. From the **Line** list, choose **None**.
- 7 Find the **Line markers** subsection. From the **Marker** list, choose **Square**.
- 8 Locate the **Legends** section. Select the **Show legends** check box.
- 9 From the **Legends** list, choose **Manual**.
- 10 In the table, enter the following settings:

Legends
Simulated

- 11 In the **ID Plot Group 1** toolbar, click  **Plot**.

Table Graph 1

- 1 In the **Model Builder** window, right-click **ID Plot Group 1** and choose **Table Graph**.
- 2 In the **Settings** window for **Table Graph**, click to expand the **Legends** section.
- 3 Select the **Show legends** check box.
- 4 From the **Legends** list, choose **Manual**.
- 5 In the table, enter the following settings:

Legends
Analytical

6 In the **ID Plot Group 1** toolbar, click  **Plot**.

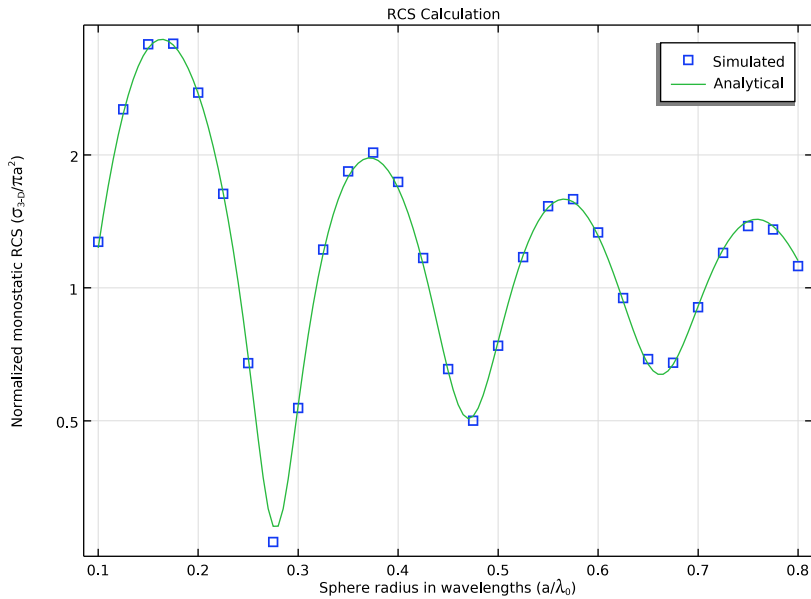

The observed RCS graph pattern is oscillatory in the Mie region. The simulation and the analytical calculation agree very well as expected.

Next, proceed to perform the mesh convergence study at the first resonance in the Mie region.

Start by extending the parameter list with the resonant radius and the associated theoretical RCS value.

GLOBAL DEFINITIONS

Parameters 1

Add the two rows at the end and change the first line according to.

1 In the **Model Builder** window, under **Global Definitions** click **Parameters 1**.

2 In the **Settings** window for **Parameters**, locate the **Parameters** section.

3 In the table, enter the following settings:

Name	Expression	Value	Description
r_lda	r1	0.16364	Sphere radius in wavelengths
r0	5[cm]	0.05 m	Sphere radius
lda	r0/r_lda	0.30556 m	Wavelength
k0	2*pi/lda	20.563 1/m	Wavenumber
f0	c_const/lda	9.8114E8 1/s	Frequency
t_air	lda/2	0.15278 m	Thickness of air around sphere
t_pml	lda/2	0.15278 m	Thickness of PML
h_size	8	8	Number of elements per wavelength
E0	1[V/m]	1 V/m	Incident field magnitude
rho	2*pi*r_lda	1.0282	Sphere circumference in wavelengths
r1	0.16363636363636364	0.16364	Relative radius at 1st resonance
RCS1	3.6549540474068576	3.655	RCS at 1st resonance

MESH 1

Add a new mesh with some tweaks to make sure that the curvature of the sphere is always resolved.

This is to avoid inverted mesh elements.

1 In the **Model Builder** window, under **Component 1 (comp1)** right-click **Mesh 1** and choose **Duplicate**.

MESH 2

Size

1 In the **Model Builder** window, expand the **Mesh 2** node, then click **Size**.

2 In the **Settings** window for **Size**, locate the **Element Size Parameters** section.

3 In the **Minimum element size** text field, type $\text{if}(lda/h_size > r0/2, r0/2, lda/h_size)$.



Size 1

- 1 In the **Model Builder** window, right-click **Free Tetrahedral 1** and choose **Size**.
- 2 In the **Settings** window for **Size**, locate the **Geometric Entity Selection** section.
- 3 From the **Geometric entity level** list, choose **Boundary**.
- 4 Click  **Paste Selection**.
- 5 In the **Paste Selection** dialog box, type 7, 10 in the **Selection** text field.
- 6 Click **OK**.
- 7 In the **Settings** window for **Size**, locate the **Element Size** section.
- 8 Click the **Custom** button.
- 9 Locate the **Element Size Parameters** section.
- 10 Select the **Maximum element size** check box. In the associated text field, type $\text{if}(1da/h_size > r0/2, r0/2, 1da/h_size)$.

ROOT

Add a new frequency domain study for the mesh convergence analysis.



ADD STUDY

- 1 In the **Home** toolbar, click  **Add Study** to open the **Add Study** window.
- 2 Go to the **Add Study** window.
- 3 Find the **Studies** subsection. In the **Select Study** tree, select **General Studies > Frequency Domain**.
- 4 Click **Add Study** in the window toolbar.
- 5 In the **Home** toolbar, click  **Add Study** to close the **Add Study** window.

STUDY 2

A parametric sweep is needed to loop over the mesh sizes.

Parametric Sweep

- 1 In the **Study** toolbar, click  **Parametric Sweep**.
- 2 In the **Settings** window for **Parametric Sweep**, locate the **Study Settings** section.
- 3 Click  **Add**.
- 4 In the table, enter the following settings:

Parameter name	Parameter value list	Parameter unit
h_size (Number of elements per wavelength)	3 6 9 12 15 20	

Step 1: Frequency Domain

- 1 In the **Model Builder** window, click **Step 1: Frequency Domain**.
- 2 In the **Settings** window for **Frequency Domain**, locate the **Study Settings** section.
- 3 In the **Frequencies** text field, type f_0 .
- 4 In the **Model Builder** window, click **Study 2**.
- 5 In the **Settings** window for **Study**, locate the **Study Settings** section.
- 6 Clear the **Generate default plots** check box.
- 7 In the **Study** toolbar, click  **Compute**.

RESULTS

Continue to plot the relative error versus elements per wavelength.

ID Plot Group 2

- 1 In the **Home** toolbar, click  **Add Plot Group** and choose **ID Plot Group**.
- 2 In the **Settings** window for **ID Plot Group**, locate the **Data** section.
- 3 From the **Dataset** list, choose **Study 2/Parametric Solutions 2 (sol33)**.
- 4 Locate the **Plot Settings** section.
- 5 Select the **x-axis label** check box. In the associated text field, type $\text{Number of elements} / \lambda_{>0}$.
- 6 Select the **y-axis label** check box. In the associated text field, type **Relative error**.

Point Graph 1

- 1 Right-click **ID Plot Group 2** and choose **Point Graph**.
- 2 In the **Settings** window for **Point Graph**, locate the **Selection** section.
- 3 Click  **Paste Selection**.
- 4 In the **Paste Selection** dialog box, type 2 in the **Selection** text field.
- 5 Click **OK**.
- 6 In the **Settings** window for **Point Graph**, locate the **y-Axis Data** section.
- 7 In the **Expression** text field, type $(\text{emw.bRCS3D} / (\pi * r_0^2) - \text{RCS1}) / \text{RCS1}$.
- 8 Locate the **x-Axis Data** section. From the **Axis source data** list, choose **h_size**.
- 9 From the **Parameter** list, choose **Expression**.
- 10 In the **Expression** text field, type **h_size**.
- 11 Locate the **Coloring and Style** section. From the **Width** list, choose 2.
- 12 Find the **Line markers** subsection. From the **Marker** list, choose **Square**.

13 Click the  **x-Axis Log Scale** button in the **Graphics** toolbar.

14 Click the  **y-Axis Log Scale** button in the **Graphics** toolbar.

15 In the **1D Plot Group 2** toolbar, click  **Plot**.

Compare the convergence plot with that shown in [Figure 4](#).

