



A Low-Pass and Band-Pass Filter Using Lumped Elements

Introduction

Passive devices can be designed using lumped element features if both the operating frequency of the device and the insertion loss of lumped elements are low. This example simulates two types of lumped element filters. First, a 5-element maximally flat low-pass filter is built to compute frequency responses that show the cutoff at the intended frequency. Second, a band-pass filter transformed from the low-pass filter design is simulated in the same frequency range. Both filter models present S-parameters and electric field distribution by default.

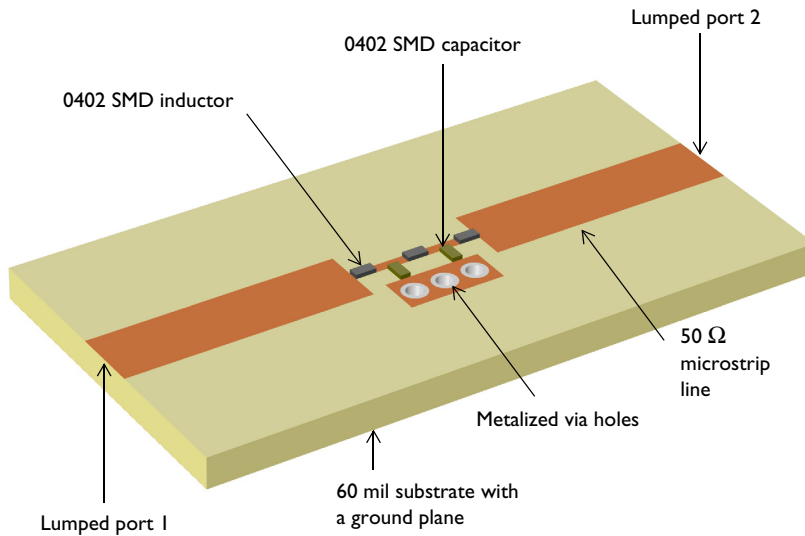

Figure 1: 0402 surface-mount device (SMD) inductors and capacitors are modeled using lumped element features on 2D boundaries. The figure describes only a low-pass filter model.

Model Definition

This example shows a filter design with five SMD devices soldered to a microstrip line that sits on a 60 mil substrate with a ground plane (Figure 1). The performance of each SMD device is assumed to be ideal in the simulated frequency range. All metal parts – the microstrip line, the thin copper ground plane and the metalized via holes – are modeled as perfect electric conductors (PECs). Each end of the microstrip line is configured with a lumped port. One of the lumped ports is the source for the input signal.

The geometry of each SMD device is simplified as a 2D boundary and the electrical performance is modeled using a lumped element. Lumped elements are similar to lumped ports except that they are strictly passive and there are predefined choices for inductances and capacitance.

The dielectric constant of the substrate is $\epsilon_r = 3.38$ and the remaining volume in the model is air. The device is assumed to sit in open space, and thus the air domain is truncated using the scattering boundary condition to absorb radiation from the circuit.

LOW-PASS FILTER

The filter in this example consists of inductors connected in series and capacitors connected in parallel. The capacitors are connected to a small section of microstrip line that is, in turn, connected to the metal vias shorted to the ground plane. The element values – either L or C – of the desired filter are defined by

$$g_k = 2 \sin\left(\frac{2k-1}{2N}\pi\right)$$

The calculated values are shown in [Table 1](#).

TABLE 1: MAXIMALLY FLAT LOW-PASS FILTER ELEMENT VALUES, $N = 5$.

g_1	g_2	g_3	g_4	g_5	g_6
0.618	1.618	2	1.618	0.618	1

These values are determined assuming that the reference impedance is 1Ω and the cutoff frequency of the filter is 1 Hz. However, for the particular filter in the model, the reference impedance is 50Ω and the cutoff frequency is 1 GHz. The filter element values, L and C , are scaled using the equations below, where R_0 is reference impedance and f_c is cutoff frequency of the filter.

$$L'_k = \frac{R_0 L_k}{2\pi f_c}, \quad C'_k = \frac{C_k}{2\pi f_c R_0}$$

The resulting scaled element values are $L_1 = L_3 = 4.9179$ nH, $L_2 = 15.915$ nH and $C_1 = C_2 = 5.1503$ pF.

BAND-PASS FILTER

The low-pass filter can be converted to a band-pass filter by transforming series inductors (L) and parallel capacitors (C) to a series LC and a parallel LC circuit, respectively. The value of transformed lumped elements are scaled by impedance and frequency based on the element values for the low pass filter prototype ([Table 1](#)).

In a series LC circuit,

$$L'_k = \frac{L_k Z_0}{2\pi f_c \Delta}, C'_k = \frac{\Delta}{2\pi f_c L_k Z_0}$$

In a parallel LC circuit,

$$L'_k = \frac{\Delta Z_0}{2\pi f_c C_k}, C'_k = \frac{C_k}{2\pi f_c \Delta Z_0}$$

where f_c is used for the center frequency of the filter and Δ is the fractional bandwidth defined as bandwidth/ f_c .

Results and Discussion

The norm of the electric field underneath the microstrip lines at 2 GHz is plotted in [Figure 2](#). This frequency is outside the passband of the filter and the plot illustrates that the signal is blocked. In [Figure 3](#), the norm of the field is plotted at 0.3 GHz, which is within the passband of the filter. The plot shows that the wave propagates through the filter.

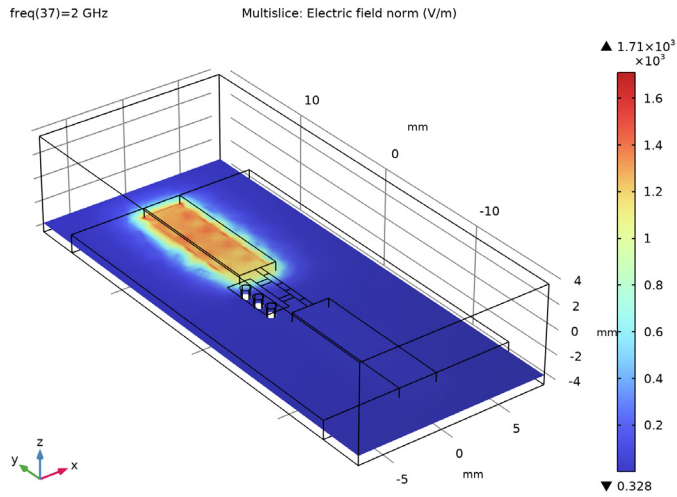

Figure 2: The norm of the electric field at 2 GHz, which is outside the passband of the filter, shows that the energy from the input port cannot reach the output port.

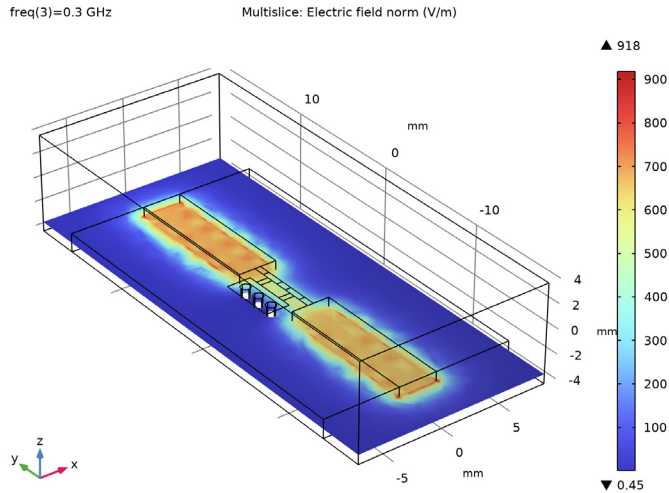

Figure 3: The norm of the electric field is plotted at 0.3 GHz, which is within the passband of the filter. The SMD filter lets the signal pass from the input port to the output port.

The calculated S-parameters, plotted in Figure 4, show a low-pass filter frequency response with 1 GHz cutoff frequency. A small frequency shift is observed due to the parasitic reactance caused by the metal pads and via holes connecting the SMD devices to the ground plane.

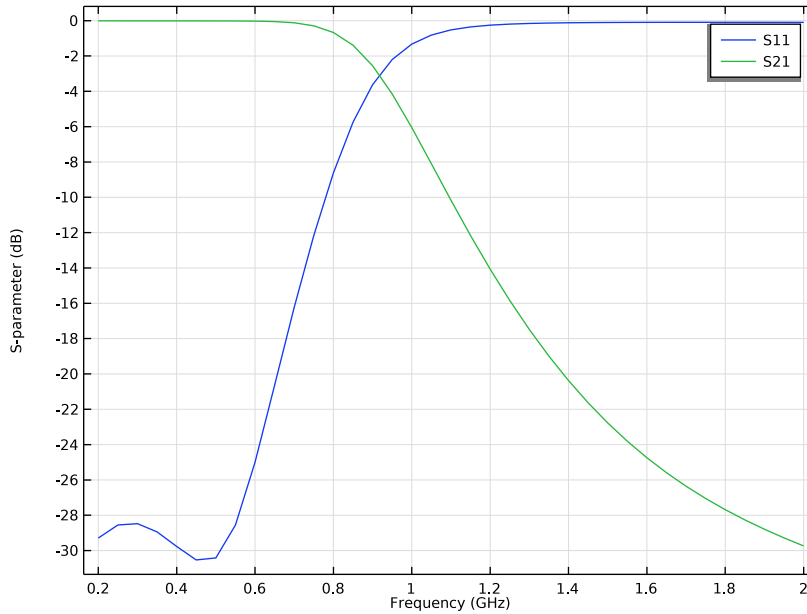

Figure 4: The S-parameters are plotted as a function of frequency to illustrate the filter response. The cutoff frequency of the low-pass filter is observed near 1 GHz.

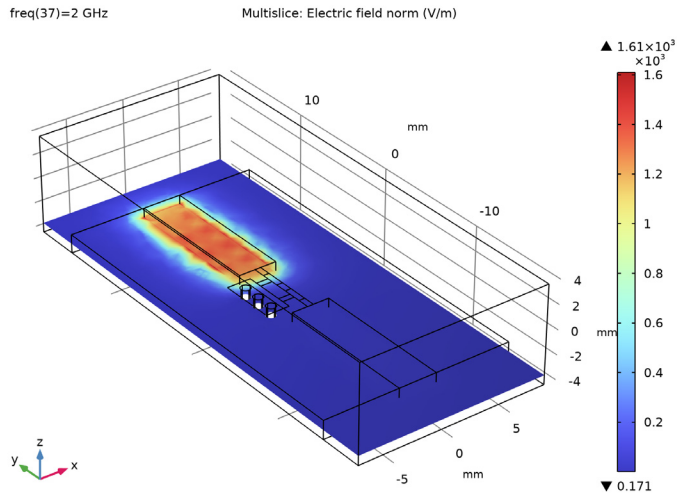

Figure 5: The norm of the electric field at 2 GHz, which is outside the passband of the filter, shows that the energy from the input port cannot reach the output port.

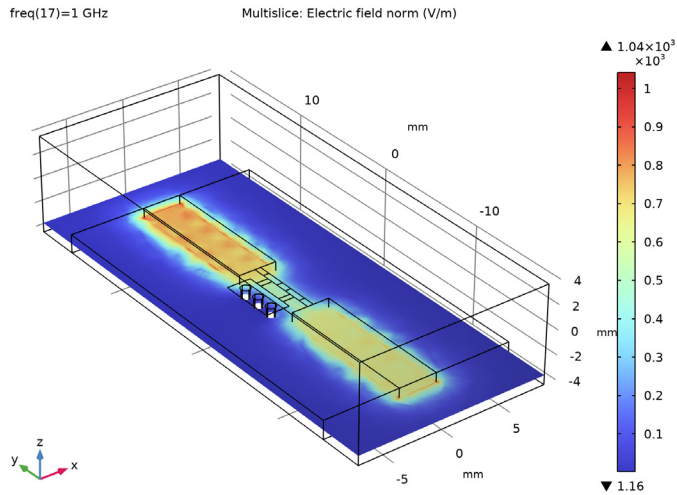

Figure 6: The norm of the electric field is plotted at 1 GHz, which is within the passband of the filter. The SMD filter lets the signal pass from the input port to the output port.

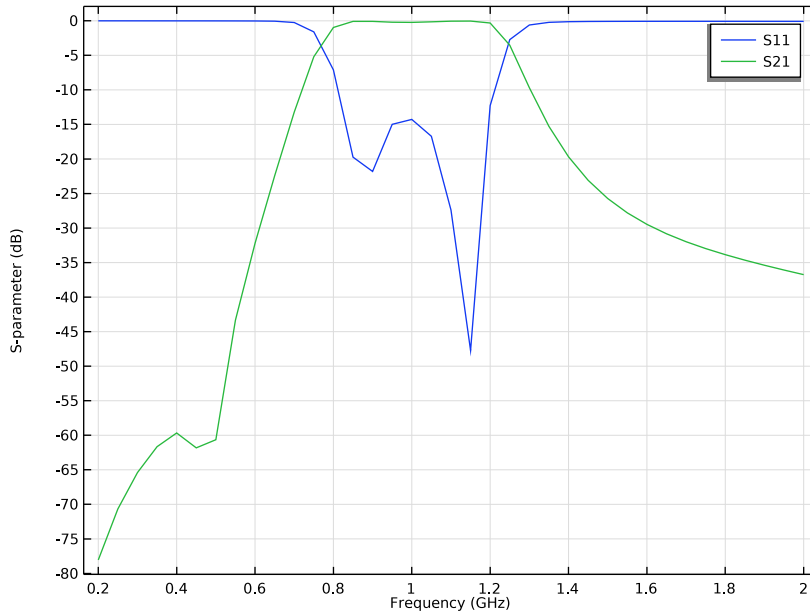

Figure 7: The S-parameter plot illustrates the frequency response of the band-pass filter. The center frequency is observed at 1 GHz.

The S-parameters of the band-pass filter are plotted in Figure 7. Due to the parasitic reactance from the metal pads and via holes, the frequency responses outside the passband are not ideal as those obtained from a circuit theory.

Reference

1. D.M. Pozar, *Microwave Engineering*, John Wiley & Sons, 1998.
2. R.E. Collin, *Foundation of Microwave Engineering*, McGraw-Hill, 1992.

Application Library path: RF_Module/Filters/lumped_element_filter



Modeling Instructions

From the **File** menu, choose **New**.

NEW

In the **New** window, click  **Model Wizard**.

MODEL WIZARD

- 1 In the **Model Wizard** window, click  **3D**.
- 2 In the **Select Physics** tree, select **Radio Frequency>Electromagnetic Waves, Frequency Domain (emw)**.
- 3 Click **Add**.
- 4 Click  **Study**.
- 5 In the **Select Study** tree, select **General Studies>Frequency Domain**.
- 6 Click  **Done**.

STUDY I

Step 1: Frequency Domain

- 1 In the **Model Builder** window, under **Study I** click **Step 1: Frequency Domain**.
- 2 In the **Settings** window for **Frequency Domain**, locate the **Study Settings** section.
- 3 In the **Frequencies** text field, type range (0.2[GHz], 0.05[GHz], 2[GHz]).

GLOBAL DEFINITIONS

Parameters I

- 1 In the **Model Builder** window, under **Global Definitions** click **Parameters I**.
- 2 In the **Settings** window for **Parameters**, locate the **Parameters** section.
- 3 In the table, enter the following settings:



Name	Expression	Value	Description
thickness	60[mil]	0.001524 m	Substrate thickness
fc	1[GHz]	1E9 Hz	Cutoff frequency
z0	50[ohm]	50 Ω	Reference impedance
l1	$z0 * 0.618 / 2 / \pi / fc$	4.9179E-9 H	Inductance l1
c1	$1.618 / z0 / 2 / \pi / fc$	5.1503E-12 F	Capacitance c1
l2	$z0 * 2 / 2 / \pi / fc$	1.5915E-8 H	Inductance l2

Here, mil refers to the unit milliinch.

GEOMETRY 1

- 1 In the **Model Builder** window, under **Component 1 (comp1)** click **Geometry 1**.
- 2 In the **Settings** window for **Geometry**, locate the **Units** section.
- 3 From the **Length unit** list, choose **mm**.

Block 1 (blk1)

- 1 In the **Geometry** toolbar, click  **Block**.
- 2 In the **Settings** window for **Block**, locate the **Size and Shape** section.
- 3 In the **Width** text field, type 16.
- 4 In the **Depth** text field, type 37.5.
- 5 In the **Height** text field, type 8.
- 6 Locate the **Position** section. From the **Base** list, choose **Center**.
- 7 Click  **Build Selected**.
- 8 Click the  **Wireframe Rendering** button in the **Graphics** toolbar.

Block 2 (blk2)

- 1 In the **Geometry** toolbar, click  **Block**.
- 2 In the **Settings** window for **Block**, locate the **Size and Shape** section.
- 3 In the **Width** text field, type 16.
- 4 In the **Depth** text field, type 30.
- 5 In the **Height** text field, type thickness.
- 6 Locate the **Position** section. From the **Base** list, choose **Center**.
- 7 In the **z** text field, type $-4 + \text{thickness}/2$.



Block 3 (blk3)

- 1 In the **Geometry** toolbar, click  **Block**.
- 2 In the **Settings** window for **Block**, locate the **Size and Shape** section.
- 3 In the **Width** text field, type 3.2.
- 4 In the **Depth** text field, type 11.9.
- 5 In the **Height** text field, type thickness.
- 6 Locate the **Position** section. From the **Base** list, choose **Center**.
- 7 In the **y** text field, type 9.05.
- 8 In the **z** text field, type $-4 + \text{thickness}/2$.

Mirror 1 (mir1)

- 1 In the **Geometry** toolbar, click  **Transforms** and choose **Mirror**.
- 2 Select the object **blk3** only.
- 3 In the **Settings** window for **Mirror**, locate the **Input** section.
- 4 Select the **Keep input objects** check box.
- 5 Locate the **Normal Vector to Plane of Reflection** section. In the **y** text field, type -1.
- 6 In the **z** text field, type 0.

Work Plane 1 (wp1)

- 1 In the **Geometry** toolbar, click  **Work Plane**.
- 2 In the **Settings** window for **Work Plane**, locate the **Plane Definition** section.
- 3 In the **z-coordinate** text field, type -4+thickness.
- 4 Click  **Show Work Plane**.

Work Plane 1 (wp1)>Rectangle 1 (r1)

- 1 In the **Work Plane** toolbar, click  **Rectangle**.
- 2 In the **Settings** window for **Rectangle**, locate the **Size and Shape** section.
- 3 In the **Width** text field, type 0.5.
- 4 In the **Height** text field, type 3.6.
- 5 Locate the **Position** section. From the **Base** list, choose **Center**.
- 6 In the **yw** text field, type 1.3.
- 7 Click to expand the **Layers** section. In the table, enter the following settings:



Layer name	Thickness (mm)
Layer 1	1

- 8 Select the **Layers on top** check box.

Work Plane 1 (wp1)>Rectangle 2 (r2)

- 1 In the **Work Plane** toolbar, click  **Rectangle**.
- 2 In the **Settings** window for **Rectangle**, locate the **Size and Shape** section.
- 3 In the **Height** text field, type 0.5.
- 4 Locate the **Position** section. From the **Base** list, choose **Center**.
- 5 In the **xw** text field, type -0.75.
- 6 In the **yw** text field, type 1.3.

Work Plane 1 (wp1)>Mirror 1 (mir1)

- 1 In the **Work Plane** toolbar, click  **Transforms** and choose **Mirror**.
- 2 Click in the **Graphics** window and then press Ctrl+A to select both objects.
- 3 In the **Settings** window for **Mirror**, locate the **Input** section.
- 4 Select the **Keep input objects** check box.
- 5 Locate the **Normal Vector to Line of Reflection** section. In the **xw** text field, type 0.
- 6 In the **yw** text field, type 1.
- 7 Click  **Build Selected**.

Work Plane 1 (wp1)>Rectangle 3 (r3)

- 1 In the **Work Plane** toolbar, click  **Rectangle**.
- 2 In the **Settings** window for **Rectangle**, locate the **Position** section.
- 3 In the **xw** text field, type -3.25.
- 4 In the **yw** text field, type -2.3.
- 5 Locate the **Size and Shape** section. In the **Width** text field, type 2.
- 6 In the **Height** text field, type 4.6.

Cylinder 1 (cyl1)

- 1 In the **Model Builder** window, right-click **Geometry 1** and choose **Cylinder**.
- 2 In the **Settings** window for **Cylinder**, locate the **Size and Shape** section.
- 3 In the **Radius** text field, type 0.4.
- 4 In the **Height** text field, type thickness.
- 5 Locate the **Position** section. In the **x** text field, type -2.25.
- 6 In the **y** text field, type -1.5.
- 7 In the **z** text field, type -4.

Array 1 (arr1)

- 1 In the **Geometry** toolbar, click  **Transforms** and choose **Array**.
- 2 Select the object **cyl1** only.
- 3 In the **Settings** window for **Array**, locate the **Size** section.
- 4 In the **y size** text field, type 3.
- 5 Locate the **Displacement** section. In the **y** text field, type 1.5.

6 Click  **Build All Objects**.

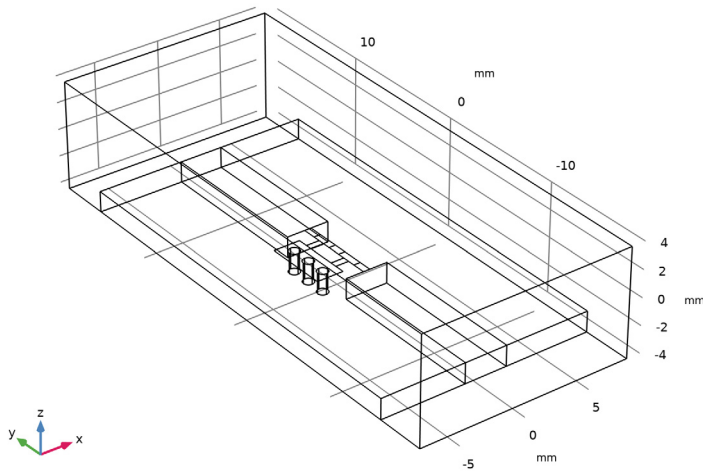

The finished geometry should look like this.

Set up the physics. Use lumped ports for the S-parameter analysis and lumped elements to model the SMD devices.

ELECTROMAGNETIC WAVES, FREQUENCY DOMAIN (EMW)

1 In the **Model Builder** window, under **Component 1 (comp1)** click **Electromagnetic Waves, Frequency Domain (emw)**.

2 Select Domains 1, 2, 6, and 7 only.

Perfect Electric Conductor 2

1 In the **Physics** toolbar, click  **Boundaries** and choose **Perfect Electric Conductor**.

2 Select Boundaries 7, 12, 33, 34, 38, 39, 45, and 47 only.

You can do this most easily by copying the text '7, 12, 33, 34, 38, 39, 45, and 47', clicking in the selection box, and then pressing Ctrl+V, or by using the **Paste Selection** dialog box.

Lumped Port 1

1 In the **Physics** toolbar, click  **Boundaries** and choose **Lumped Port**.

2 Select Boundary 40 only.

For the first port, wave excitation is **on** by default.

Lumped Port 2

- 1 In the **Physics** toolbar, click  **Boundaries** and choose **Lumped Port**.
- 2 Select Boundary 32 only.

Lumped Element 1

- 1 In the **Physics** toolbar, click  **Boundaries** and choose **Lumped Element**.
- 2 Select Boundary 48 only.
- 3 In the **Settings** window for **Lumped Element**, locate the **Settings** section.
- 4 From the **Lumped element device** list, choose **Inductor**.
- 5 In the L_{element} text field, type 11.

Lumped Element 2

- 1 In the **Physics** toolbar, click  **Boundaries** and choose **Lumped Element**.
- 2 Select Boundary 46 only.
- 3 In the **Settings** window for **Lumped Element**, locate the **Settings** section.
- 4 From the **Lumped element device** list, choose **Inductor**.
- 5 In the L_{element} text field, type 12.

Lumped Element 3

- 1 In the **Physics** toolbar, click  **Boundaries** and choose **Lumped Element**.
- 2 Select Boundary 44 only.
- 3 In the **Settings** window for **Lumped Element**, locate the **Settings** section.
- 4 From the **Lumped element device** list, choose **Inductor**.
- 5 In the L_{element} text field, type 11.

Lumped Element 4

- 1 In the **Physics** toolbar, click  **Boundaries** and choose **Lumped Element**.
- 2 Select Boundary 43 only.
- 3 In the **Settings** window for **Lumped Element**, locate the **Settings** section.
- 4 From the **Lumped element device** list, choose **Capacitor**.
- 5 In the C_{element} text field, type c1.

Lumped Element 5

- 1 In the **Physics** toolbar, click  **Boundaries** and choose **Lumped Element**.
- 2 Select Boundary 41 only.
- 3 In the **Settings** window for **Lumped Element**, locate the **Settings** section.

4 From the **Lumped element device** list, choose **Capacitor**.

5 In the C_{element} text field, type c1.

Scattering Boundary Condition 1

1 In the **Physics** toolbar, click  **Boundaries** and choose **Scattering Boundary Condition**.

2 Select Boundaries 1, 2, 4, 5, 11, 54, and 55 only.

ADD MATERIAL

1 In the **Home** toolbar, click  **Add Material** to open the **Add Material** window.

2 Go to the **Add Material** window.

3 In the tree, select **Built-in>Air**.

4 Click **Add to Component** in the window toolbar.

5 In the **Home** toolbar, click  **Add Material** to close the **Add Material** window.

MATERIALS

Material 2 (mat2)

1 In the **Model Builder** window, under **Component 1 (comp1)** right-click **Materials** and choose **Blank Material**.

2 Select Domains 2, 6, and 7 only.

3 In the **Settings** window for **Material**, locate the **Material Contents** section.

4 In the table, enter the following settings:

Property	Variable	Value	Unit	Property group
Relative permittivity	epsilon _{nr_} iso ; epsilon _{nrii} = epsilon _{nr_} iso, epsilon _{nrij} = 0	3.38		Basic
Relative permeability	mu _{r_} iso ; mu _{rii} = mu _{r_} iso, mu _{rij} = 0	1		Basic
Electrical conductivity	sigma _{iso} ; sigma _{ii} = sigma _{iso} , sigma _{ij} = 0	0	S/m	Basic

MESH 1

In the **Model Builder** window, under **Component 1 (comp1)** right-click **Mesh 1** and choose **Build All**.

DEFINITIONS

Hide for Physics 1

- 1 In the **Model Builder** window, expand the **Component 1 (comp1)>Definitions** node.
- 2 Right-click **View 1** and choose **Hide for Physics**.
- 3 In the **Settings** window for **Hide for Physics**, locate the **Geometric Entity Selection** section.
- 4 From the **Geometric entity level** list, choose **Boundary**.
- 5 Select Boundaries 1, 2, and 4 only.

MESH 1

In the **Model Builder** window, click **Mesh 1**.

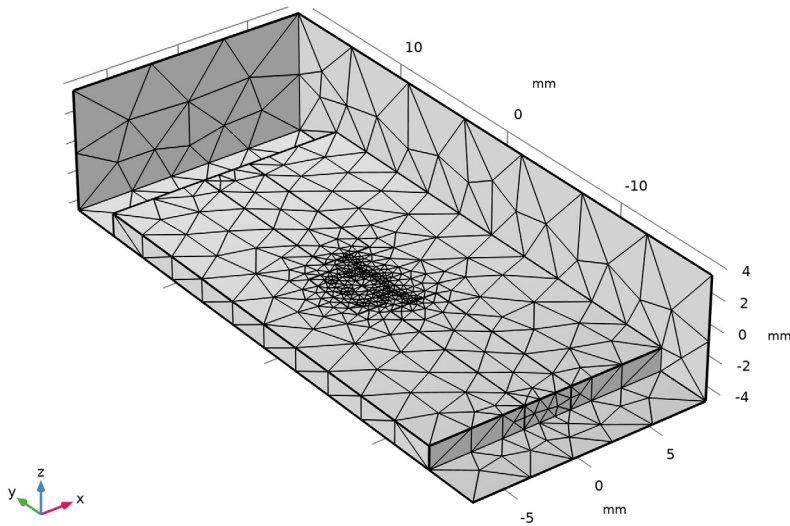

The meshed structure should look like this figure.

STUDY 1

In the **Home** toolbar, click  **Compute**.

RESULTS

Multislice

Modify the settings to show the plot only on the xy -plane.

- 1 In the **Model Builder** window, expand the **Electric Field (emw)** node, then click **Multislice**.
- 2 In the **Settings** window for **Multislice**, locate the **Multipane Data** section.
- 3 Find the **X-planes** subsection. In the **Planes** text field, type 0.
- 4 Find the **Y-planes** subsection. In the **Planes** text field, type 0.
- 5 Find the **Z-planes** subsection. From the **Entry method** list, choose **Coordinates**.
- 6 In the **Coordinates** text field, type $-4+thickness/2$.
- 7 In the **Electric Field (emw)** toolbar, click  **Plot**.

This reproduces [Figure 2](#) showing the electric field distribution outside the passband.

Electric Field (emw)

- 1 In the **Model Builder** window, click **Electric Field (emw)**.
- 2 In the **Settings** window for **3D Plot Group**, locate the **Data** section.
- 3 From the **Parameter value (freq (GHz))** list, choose **0.3**.
- 4 In the **Electric Field (emw)** toolbar, click  **Plot**.

Compare the reproduced plot with [Figure 3](#) showing the electric field distribution inside the passband.

S-parameter (emw)

This shows the frequency response of the low-pass filter. See [Figure 4](#).

Smith Plot (emw)

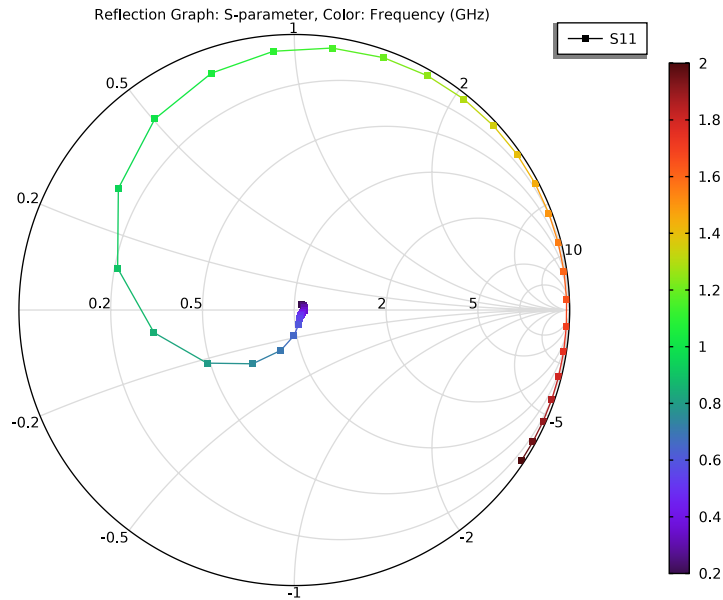

GLOBAL DEFINITIONS

Parameters 1

- 1 In the **Model Builder** window, under **Global Definitions** click **Parameters 1**.
- 2 In the **Settings** window for **Parameters**, locate the **Parameters** section.
- 3 In the table, enter the following settings:

Name	Expression	Value	Description
del	$500[\text{MHz}]/f_c$	0.5	Fractional bandwidth
l1_inductor	$0.618 \cdot z_0 / 2 / \pi / f_c / \text{del}$	9.8358E-9 H	Scaled inductance from l1
l1_capacitor	$\text{del} / 2 / \pi / f_c / 0.618 / z_0$	2.5753E-12 F	Scaled capacitance from l1
l2_inductor	$2 \cdot z_0 / 2 / \pi / f_c / \text{del}$	3.1831E-8 H	Scaled inductance from l2
l2_capacitor	$\text{del} / 2 / \pi / f_c / 2 / z_0$	7.9577E-13 F	Scaled capacitance from l2

Name	Expression	Value	Description
c1_inductor	$\text{del} * z_0 / 2 / \pi / f_c / 1.618$	2.4591E-9 H	Scaled inductance from c1
c1_capacitor	$1.618 / 2 / \pi / f_c / \text{del} / z_0$	1.0301E-11 F	Scaled capacitance from c1

ELECTROMAGNETIC WAVES, FREQUENCY DOMAIN (EMW)

Lumped Element 1

- 1 In the **Model Builder** window, expand the **Component 1 (comp1)>Electromagnetic Waves, Frequency Domain (emw)>Lumped Element 1** node, then click **Lumped Element 1**.
- 2 In the **Settings** window for **Lumped Element**, locate the **Settings** section.
- 3 From the **Lumped element device** list, choose **Series LC**.
- 4 In the L_{element} text field, type l1_inductor.
- 5 In the C_{element} text field, type l1_capacitor.

Lumped Element 2

- 1 In the **Model Builder** window, click **Lumped Element 2**.
- 2 In the **Settings** window for **Lumped Element**, locate the **Settings** section.
- 3 From the **Lumped element device** list, choose **Series LC**.
- 4 In the L_{element} text field, type l2_inductor.
- 5 In the C_{element} text field, type l2_capacitor.

Lumped Element 3

- 1 In the **Model Builder** window, click **Lumped Element 3**.
- 2 In the **Settings** window for **Lumped Element**, locate the **Settings** section.
- 3 From the **Lumped element device** list, choose **Series LC**.
- 4 In the L_{element} text field, type l1_inductor.
- 5 In the C_{element} text field, type l1_capacitor.



Lumped Element 4

- 1 In the **Model Builder** window, click **Lumped Element 4**.
- 2 In the **Settings** window for **Lumped Element**, locate the **Settings** section.
- 3 From the **Lumped element device** list, choose **Parallel LC**.
- 4 In the L_{element} text field, type c1_inductor.
- 5 In the C_{element} text field, type c1_capacitor.

Lumped Element 5

- 1 In the **Model Builder** window, click **Lumped Element 5**.
- 2 In the **Settings** window for **Lumped Element**, locate the **Settings** section.
- 3 From the **Lumped element device** list, choose **Parallel LC**.
- 4 In the L_{element} text field, type `c1_inductor`.
- 5 In the C_{element} text field, type `c1_capacitor`.

ADD STUDY

- 1 In the **Home** toolbar, click  **Add Study** to open the **Add Study** window.
- 2 Go to the **Add Study** window.
- 3 Find the **Studies** subsection. In the **Select Study** tree, select **General Studies > Frequency Domain**.
- 4 Click **Add Study** in the window toolbar.
- 5 In the **Home** toolbar, click  **Add Study** to close the **Add Study** window.

STUDY 2

Step 1: Frequency Domain

- 1 In the **Settings** window for **Frequency Domain**, locate the **Study Settings** section.
- 2 In the **Frequencies** text field, type `range(0.2[GHz],0.05[GHz],2[GHz])`.
- 3 In the **Home** toolbar, click  **Compute**.

RESULTS

Multislice

Modify the settings to show the plot only on the xy -plane.

- 1 In the **Model Builder** window, expand the **Electric Field (emw) 1** node, then click **Multislice**.
- 2 In the **Settings** window for **Multislice**, locate the **Multiplane Data** section.
- 3 Find the **X-planes** subsection. In the **Planes** text field, type `0`.
- 4 Find the **Y-planes** subsection. In the **Planes** text field, type `0`.
- 5 Find the **Z-planes** subsection. From the **Entry method** list, choose **Coordinates**.
- 6 In the **Coordinates** text field, type `-4+thickness/2`.
- 7 In the **Electric Field (emw) 1** toolbar, click  **Plot**.

This reproduces [Figure 5](#) showing the electric field distribution outside the passband.

Electric Field (emw) 1

- 1 In the **Model Builder** window, click **Electric Field (emw) 1**.
- 2 In the **Settings** window for **3D Plot Group**, locate the **Data** section.
- 3 From the **Parameter value (freq (GHz))** list, choose **1**.
- 4 In the **Electric Field (emw) 1** toolbar, click  **Plot**.

Compare the reproduced plot with [Figure 6](#) showing the electric field distribution inside the passband.

S-parameter (emw) 1

The frequency response (S-parameters) is shown in [Figure 7](#).

Smith Plot (emw) 1

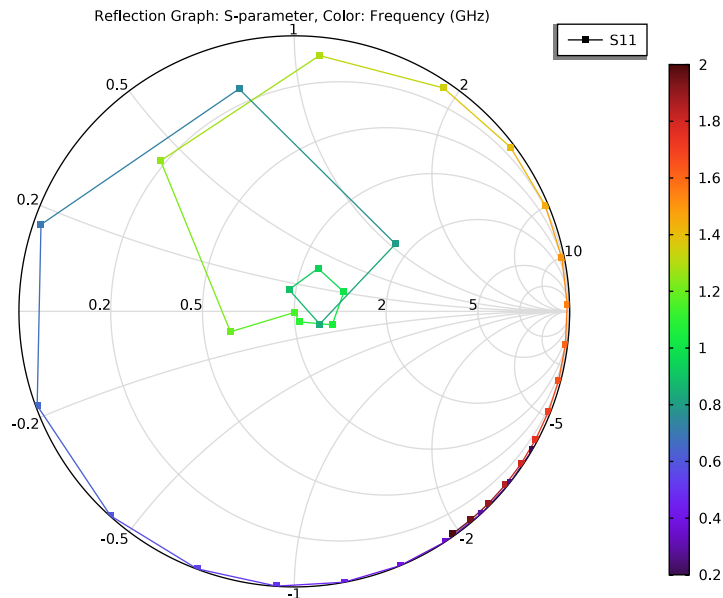

Analyze the same bandpass filter model with a much finer frequency resolution using **Adaptive Frequency Sweep** based on asymptotic waveform evaluation (AWE). When a device presents a slowly varying frequency response, the AWE method provides a faster solution time when running the simulation on many frequency points. The following example with the Adaptive Frequency Sweep can be computed about twenty times faster than regular Frequency Domain sweeps with a same finer frequency resolution.

ELECTROMAGNETIC WAVES, FREQUENCY DOMAIN (EMW)



Lumped Port 1

- 1 In the **Model Builder** window, under **Component 1 (comp1)>Electromagnetic Waves, Frequency Domain (emw)** click **Lumped Port 1**.
- 2 In the **Settings** window for **Lumped Port**, locate the **Boundary Selection** section.
- 3 Click  **Create Selection**.
- 4 In the **Create Selection** dialog box, type Lumped port 1 in the **Selection name** text field.
- 5 Click **OK**.

Lumped Port 2

- 1 In the **Model Builder** window, click **Lumped Port 2**.
- 2 In the **Settings** window for **Lumped Port**, locate the **Boundary Selection** section.
- 3 Click  **Create Selection**.
- 4 In the **Create Selection** dialog box, type Lumped port 2 in the **Selection name** text field.
- 5 Click **OK**.

ADD STUDY

- 1 In the **Home** toolbar, click  **Add Study** to open the **Add Study** window.
- 2 Go to the **Add Study** window.
- 3 Find the **Studies** subsection. In the **Select Study** tree, select **Preset Studies for Selected Physics Interfaces>Adaptive Frequency Sweep**.
- 4 Click **Add Study** in the window toolbar.
- 5 In the **Home** toolbar, click  **Add Study** to close the **Add Study** window.

STUDY 3

Step 1: Adaptive Frequency Sweep

- 1 In the **Settings** window for **Adaptive Frequency Sweep**, locate the **Study Settings** section.
- 2 In the **Frequencies** text field, type range(0.2[GHz],0.001[GHz],2[GHz]).

Use a 50 times finer frequency resolution.

A slowly varying scalar value curve works well for AWE expressions. When **AWE expression type** is set to **Physics controlled** in the **Adaptive Frequency Sweep** study settings, `abs(comp1.emw.S21)` is used automatically for two-port devices.

Because such a fine frequency step generates a memory-intensive solution, the model file size will increase tremendously when it is saved. When only the frequency response

of port related variables are of interest, it is not necessary to store all of the field solutions. By selecting the **Store fields in output** check box in the **Values of Dependent Variables** section, we can control the part of the model on which the computed solution is saved. We only add the selection containing these boundaries where the port variables are calculated. The lumped port size is typically very small compared to the entire modeling domain, and the saved file size with the fine frequency step is more or less that of the regular discrete frequency sweep model when only the solutions on the port boundaries are stored.

- 3 Locate the **Values of Dependent Variables** section. Find the **Store fields in output** subsection. From the **Settings** list, choose **For selections**.
- 4 Under **Selections**, click **+ Add**.
- 5 In the **Add** dialog box, in the **Selections** list, choose **Lumped port 1** and **Lumped port 2**.
- 6 Click **OK**.

It is necessary to include the lumped port boundaries to calculate S-parameters. By choosing only the lumped port boundaries for **Store fields in output** settings, it is possible to reduce the size of a model file a lot.

- 7 In the **Home** toolbar, click **= Compute**.

RESULTS

Multislice

- 1 In the **Model Builder** window, expand the **Electric Field (emw) 2** node.
- 2 Right-click **Results>Electric Field (emw) 2>Multislice** and choose **Delete**.

Surface 1

In the **Model Builder** window, right-click **Electric Field (emw) 2** and choose **Surface**.

Selection 1

- 1 In the **Model Builder** window, right-click **Surface 1** and choose **Selection**.
- 2 Select Boundaries 32 and 40 only.
- 3 In the **Electric Field (emw) 2** toolbar, click  **Plot**.

S-parameter (emw) 2

- 1 In the **Model Builder** window, under **Results** click **S-parameter (emw) 2**.
- 2 In the **Settings** window for **ID Plot Group**, locate the **Legend** section.
- 3 From the **Position** list, choose **Lower right**.

Global 1

- 1 In the **Model Builder** window, expand the **S-parameter (emw) 2** node, then click **Global 1**.
- 2 In the **Settings** window for **Global**, locate the **y-Axis Data** section.
- 3 In the table, enter the following settings:

Expression	Unit	Description
emw.S11dB	1	S11 Adaptive Frequency Sweep
emw.S21dB	1	S21 Adaptive Frequency Sweep

Global 2

- 1 Right-click **Results>S-parameter (emw) 2>Global 1** and choose **Duplicate**.
- 2 In the **Settings** window for **Global**, locate the **Data** section.
- 3 From the **Dataset** list, choose **Study 2/Solution 2 (sol2)**.
- 4 Locate the **y-Axis Data** section. In the table, enter the following settings:

Expression	Unit	Description
emw.S11dB	1	S11 Regular Sweep
emw.S21dB	1	S21 Regular Sweep

- 5 Click to expand the **Coloring and Style** section. Find the **Line style** subsection. From the **Line** list, choose **Cycle**.
- 6 Find the **Line markers** subsection. From the **Marker** list, choose **Cycle**.

7 In the **S-parameter (emw) 2** toolbar, click  **Plot**.

