



Log-Periodic Antenna

Introduction

A log-periodic antenna is known to be a wideband or frequency-independent antenna. One of the most popular forms is a coplanar dipole array type, which is commonly used for UHF-range antenna measurements in an anechoic chamber. This example computes the voltage-standing-wave-ratio (VSWR) and far-field radiation pattern between 250 MHz and 750 MHz.

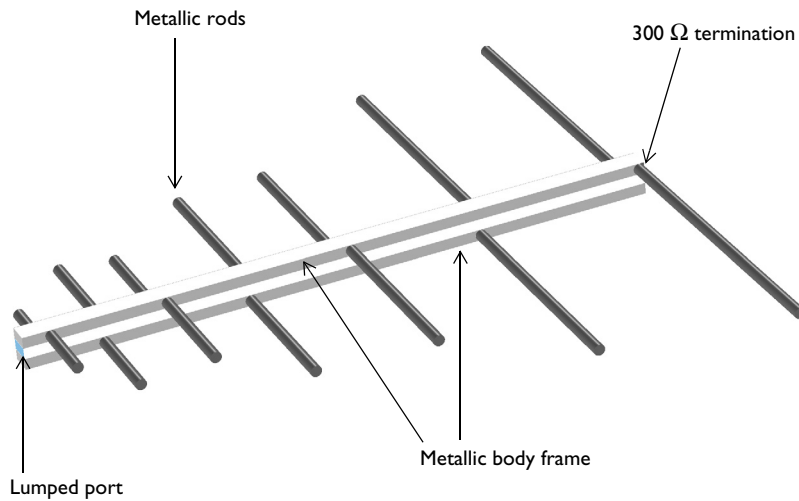

Figure 1: A log-periodic antenna is realized by fitting a coplanar dipole array through a couple of metallic body frames. The surrounding air domain and perfectly matched layers, which are required for the simulation, are not included in this figure.

Model Definition

The shape of a log-periodic antenna resembles that of a Yagi-Uda antenna. While the Yagi-Uda consists of a driven element and multiple passive elements such as a reflector and a few directors to obtain a higher gain, the log periodic antenna is composed of a coplanar array to achieve a wider bandwidth. In this log-periodic antenna model, all metallic parts are modeled using perfect electric conductor (PEC) boundary conditions since the surface loss is negligible in the given simulation frequency range. The modeling domain excludes the interior part of the antenna body, including frames and dipole rods in which wave propagation is not expected. The antenna is excited by a lumped port that is placed at one

end of the gap between two body frames at the location of a pair of the shortest rods. A lumped element with a 300Ω resistor is used to terminate the other end of the gap at the location of a pair of the longest rods. The antenna is modeled in a spherical air domain, which is enclosed by perfectly matched layers (PML) that absorb all outgoing radiation from the antenna.

The length of dipole rods is gradually decreasing with a constant ratio toward the lumped port. The repeated pattern of a radiating structure is easily built by using parameterized geometry parts.

Results and Discussion

Figure 2 shows the impedance matching properties on a Smith plot. All frequency swept complex impedance normalized by 50Ω is plotted around the spot shifted from the center of the Smith plot, that is, approximately 68Ω . The 2D far-field polar plot is visualized in Figure 3. The directionality of the radiation pattern is slightly varying as the frequency increases. The 3D far-field radiation pattern in Figure 4 shows the same tendency. Figure 5 presents the voltage-standing-wave-ratio (VSWR) of the antenna, which is better than 2:1.

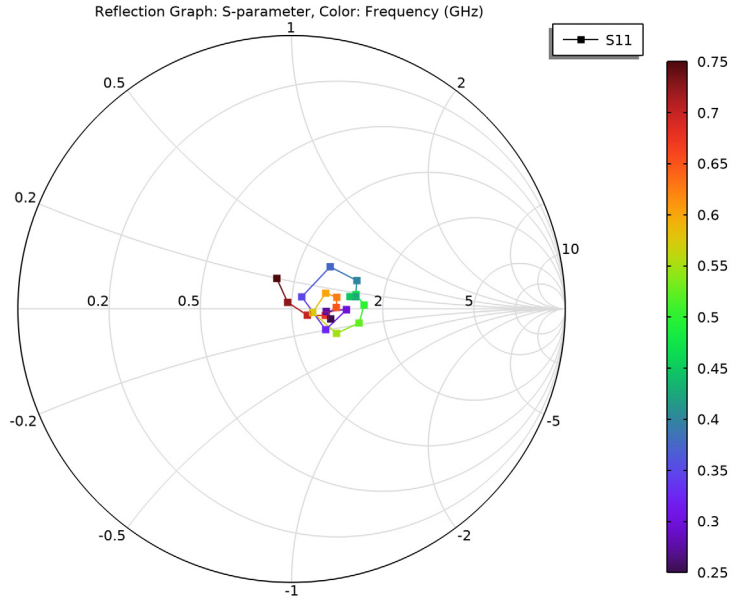

Figure 2: Smith plot of the seven-element log-periodic antenna. Each color represents a different frequency.

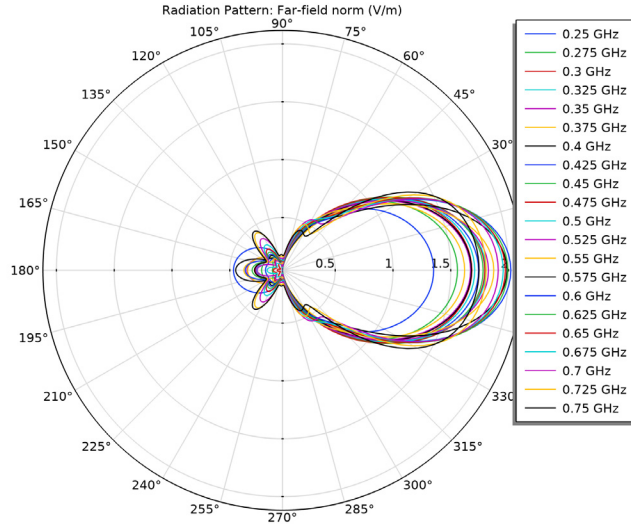

Figure 3: Far-field radiation pattern in a polar plot. It is directed toward the lumped port.

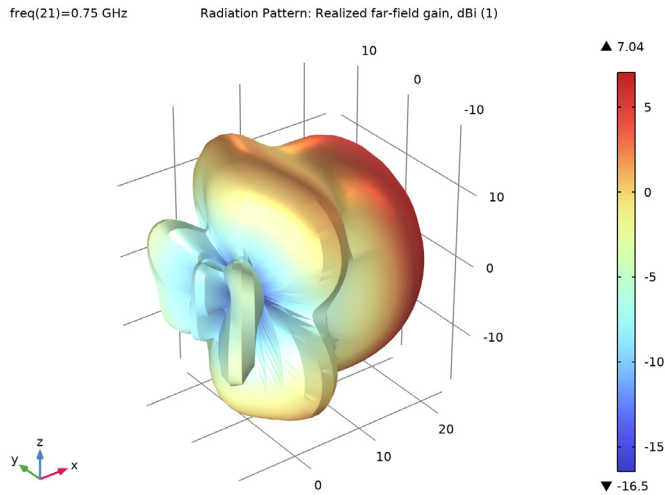

Figure 4: 3D far-field radiation pattern. Sidelobes can be visualized accurately by applying a finer angular resolution.

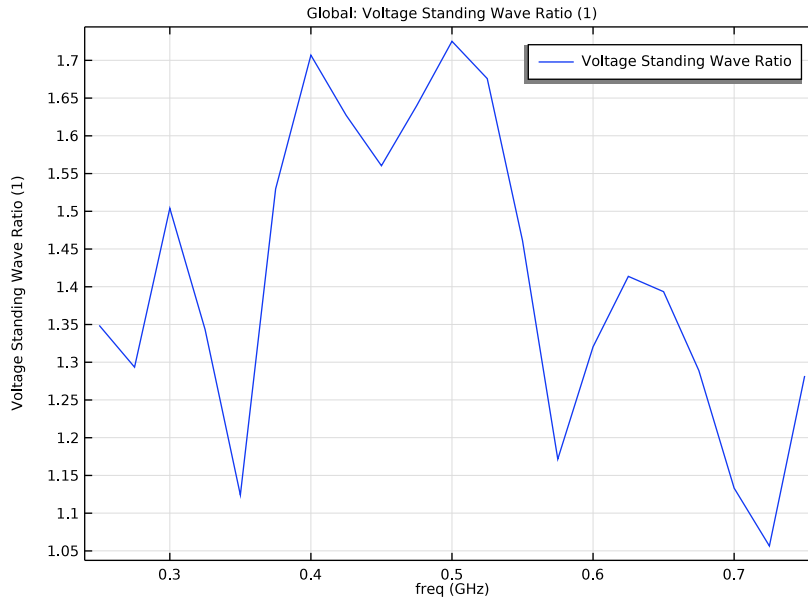



Figure 5: The computed VSWR shows the antenna impedance is close to 50Ω for all simulated frequencies

Application Library path: RF_Module/Antennas/log_periodic_antenna

Modeling Instructions

From the **File** menu, choose **New**.

NEW

In the **New** window, click  **Model Wizard**.

MODEL WIZARD

- 1** In the **Model Wizard** window, click  **3D**.
- 2** In the **Select Physics** tree, select **Radio Frequency>Electromagnetic Waves, Frequency Domain (emw)**.
- 3** Click **Add**.

- 4 Click  **Study**.
- 5 In the **Select Study** tree, select **General Studies>Frequency Domain**.
- 6 Click  **Done**.

STUDY I

Step 1: Frequency Domain

- 1 In the **Model Builder** window, under **Study I** click **Step 1: Frequency Domain**.
- 2 In the **Settings** window for **Frequency Domain**, locate the **Study Settings** section.
- 3 In the **Frequencies** text field, type range (250 [MHz] , 25 [MHz] , 750 [MHz]).

GLOBAL DEFINITIONS

Parameters 1

- 1 In the **Model Builder** window, under **Global Definitions** click **Parameters 1**.
- 2 In the **Settings** window for **Parameters**, locate the **Parameters** section.
- 3 In the table, enter the following settings:

Name	Expression	Value	Description
f_min	250 [MHz]	2.5E8 Hz	Minimum frequency
f_max	750 [MHz]	7.5E8 Hz	Maximum frequency
l_min	c_const/f_max	0.39972 m	Minimum wavelength
l_max	c_const/f_min	1.1992 m	Maximum wavelength
l0	l_max/4	0.29979 m	Longest rod length
r0	5 [mm]	0.005 m	Rod radius
d0	l_max/8	0.1499 m	Distance between first two elements
ratio	1.27	1.27	Rod scale ratio
gap	1 [cm]	0.01 m	Mounting frame gap size
zstub	300 [ohm]	300 Ω	Terminating stub impedance

Here, c_const is a predefined COMSOL constant for the speed of light in vacuum.



RODS

- 1 In the **Geometry** toolbar, click  **Parts** and choose **Create Part**.
- 2 In the **Settings** window for **Part**, type Rods in the **Label** text field.



3 Locate the **Input Parameters** section. In the table, enter the following settings:

Name	Default expression	Value	Description
n	0	0	Number of antenna rods pair

Cylinder 1 (cyl1)

- 1 In the **Geometry** toolbar, click  **Cylinder**.
- 2 In the **Settings** window for **Cylinder**, locate the **Size and Shape** section.
- 3 In the **Radius** text field, type $r0$.
- 4 In the **Height** text field, type 10.
- 5 Locate the **Position** section. In the **z** text field, type $gap/2+r0$.
- 6 Locate the **Axis** section. From the **Axis type** list, choose **y-axis**.
- 7 Click  **Build Selected**.

Rotate 1 (rot1)

- 1 In the **Geometry** toolbar, click  **Transforms** and choose **Rotate**.
- 2 Select the object **cyl1** only.
- 3 In the **Settings** window for **Rotate**, locate the **Rotation** section.
- 4 In the **Angle** text field, type 0 180.
- 5 From the **Axis type** list, choose **x-axis**.
- 6 Click  **Build Selected**.
- 7 Click the  **Go to Default View** button in the **Graphics** toolbar.

Union 1 (uni1)

- 1 In the **Geometry** toolbar, click  **Booleans and Partitions** and choose **Union**.
- 2 Click in the **Graphics** window and then press Ctrl+A to select both objects.

Scale 1 (scal)



- 1 In the **Geometry** toolbar, click  **Transforms** and choose **Scale**.
- 2 Select the object **uni1** only.
- 3 In the **Settings** window for **Scale**, locate the **Scale Factor** section.
- 4 From the **Scaling** list, choose **Anisotropic**.
- 5 In the **y** text field, type $1/ratio^n$.

Rotate 2 (rot2)

- 1 In the **Geometry** toolbar, click  **Transforms** and choose **Rotate**.

- 2 Select the object **sca1** only.
- 3 In the **Settings** window for **Rotate**, locate the **Rotation** section.
- 4 In the **Angle** text field, type $180 * \text{mod}(n, 2)$.

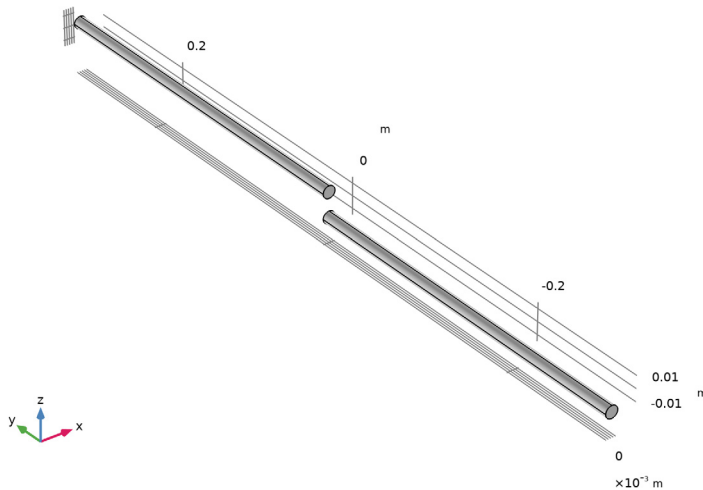

Move 1 (mov1)

- 1 In the **Geometry** toolbar, click  **Transforms** and choose **Move**.
- 2 Select the object **rot2** only.
- 3 In the **Settings** window for **Move**, locate the **Displacement** section.
- 4 In the **x** text field, type $d0 * ((n > 0) * 1 + (n > 1) * 1 / \text{ratio} + (n > 2) * 1 / \text{ratio}^2 + (n > 3) * 1 / \text{ratio}^3 + (n > 4) * 1 / \text{ratio}^4 + (n > 5) * 1 / \text{ratio}^5)$.
- 5 In the **Geometry** toolbar, click  **Build All**.



GEOMETRY I

Rods 0

- 1 In the **Geometry** toolbar, click  **Parts** and choose **Rods**.
- 2 In the **Settings** window for **Part Instance**, type **Rods_0** in the **Label** text field.
- 3 Click  **Build Selected**.

Rods 1 (pi2)

- 1 In the **Geometry** toolbar, click  **Parts** and choose **Rods**.
- 2 In the **Settings** window for **Part Instance**, locate the **Input Parameters** section.

3 In the table, enter the following settings:

Name	Expression	Value	Description
n	1	1	Number of antenna rods pair

4 Click  **Build Selected**.

Rods 2 (pi3)

1 In the **Geometry** toolbar, click  **Parts** and choose **Rods**.

2 In the **Settings** window for **Part Instance**, locate the **Input Parameters** section.

3 In the table, enter the following settings:

Name	Expression	Value	Description
n	2	2	Number of antenna rods pair

4 Click  **Build Selected**.

Rods 3 (pi4)

1 In the **Geometry** toolbar, click  **Parts** and choose **Rods**.

2 In the **Settings** window for **Part Instance**, locate the **Input Parameters** section.

3 In the table, enter the following settings:

Name	Expression	Value	Description
n	3	3	Number of antenna rods pair

4 Click  **Build Selected**.

Rods 4 (pi5)

1 In the **Geometry** toolbar, click  **Parts** and choose **Rods**.

2 In the **Settings** window for **Part Instance**, locate the **Input Parameters** section.

3 In the table, enter the following settings:

Name	Expression	Value	Description
n	4	4	Number of antenna rods pair

4 Click  **Build Selected**.

Rods 5 (pi6)

1 In the **Geometry** toolbar, click  **Parts** and choose **Rods**.

2 In the **Settings** window for **Part Instance**, locate the **Input Parameters** section.

3 In the table, enter the following settings:

Name	Expression	Value	Description
n	5	5	Number of antenna rods pair

4 Click  **Build Selected**.

Rods 6 (pi7)

1 In the **Geometry** toolbar, click  **Parts** and choose **Rods**.

2 In the **Settings** window for **Part Instance**, locate the **Input Parameters** section.

3 In the table, enter the following settings:

Name	Expression	Value	Description
n	6	6	Number of antenna rods pair

4 Click  **Build Selected**.

5 Click the  **Go to Default View** button in the **Graphics** toolbar.

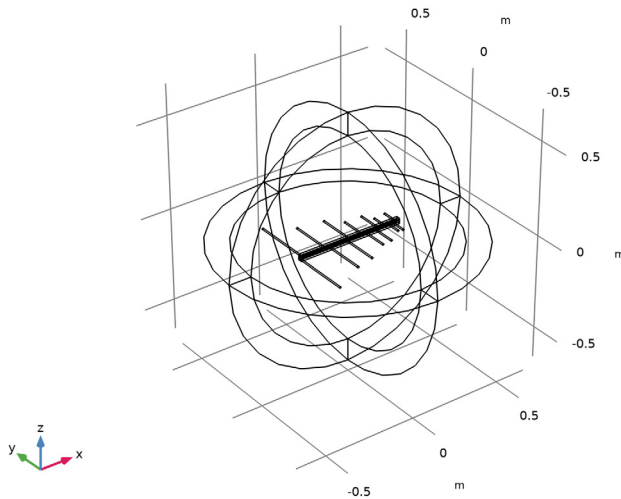

Block 1 (blk1)

1 In the **Geometry** toolbar, click  **Block**.

2 In the **Settings** window for **Block**, locate the **Size and Shape** section.

3 In the **Width** text field, type $d0 * (1 + 1/ratio + 1/ratio^2 + 1/ratio^3 + 1/ratio^4 + 1/ratio^5) + r0 * 2 + 0.02$.

- 4 In the **Depth** text field, type 0.02.
- 5 In the **Height** text field, type 0.01.
- 6 Locate the **Position** section. In the **x** text field, type -r0.
- 7 In the **y** text field, type -0.01.
- 8 In the **z** text field, type -gap/2-0.01.
- 9 Click  **Build Selected**.



Block 2 (blk2)

- 1 Right-click **Block 1 (blk1)** and choose **Duplicate**.
- 2 In the **Settings** window for **Block**, locate the **Position** section.
- 3 In the **z** text field, type gap/2.
- 4 Click  **Build Selected**.



Block 3 (blk3)

- 1 Right-click **Block 2 (blk2)** and choose **Duplicate**.
- 2 In the **Settings** window for **Block**, locate the **Size and Shape** section.
- 3 In the **Height** text field, type gap.
- 4 Locate the **Position** section. In the **z** text field, type -gap/2.
- 5 Click  **Build Selected**.

Union 1 (uni1)

- 1 In the **Geometry** toolbar, click  **Booleans and Partitions** and choose **Union**.
- 2 Select the objects **blk1**, **blk2**, **pi1**, **pi2**, **pi3**, **pi4**, **pi5**, **pi6**, and **pi7** only.
- 3 In the **Settings** window for **Union**, click  **Build Selected**.

Move 1 (mov1)

- 1 In the **Geometry** toolbar, click  **Transforms** and choose **Move**.
- 2 Click in the **Graphics** window and then press Ctrl+A to select both objects.
- 3 In the **Settings** window for **Move**, locate the **Displacement** section.
- 4 In the **x** text field, type $-d0*(1+1/ratio)$.
- 5 Click  **Build Selected**.
- 6 Click the  **Go to Default View** button in the **Graphics** toolbar.

Sphere 1 (sph1)

- 1 In the **Geometry** toolbar, click  **Sphere**.
- 2 In the **Settings** window for **Sphere**, locate the **Size** section.

3 In the **Radius** text field, type $l_{\max}/1.8$.

4 Click to expand the **Layers** section. In the table, enter the following settings:

Layer name	Thickness (m)
Layer 1	$l_{\max}*0.1$

5 Click  **Build Selected**.

6 Click the  **Go to Default View** button in the **Graphics** toolbar.

7 Click the  **Zoom In** button in the **Graphics** toolbar.

8 Click the  **Wireframe Rendering** button in the **Graphics** toolbar.

Difference 1 (dif1)

1 In the **Geometry** toolbar, click  **Booleans and Partitions** and choose **Difference**.

2 Select the object **sph1** only.

3 In the **Settings** window for **Difference**, locate the **Difference** section.

4 Find the **Objects to subtract** subsection. Click to select the  **Activate Selection** toggle button.

5 Select the object **mov1(2)** only.

6 Click  **Build All Objects**.

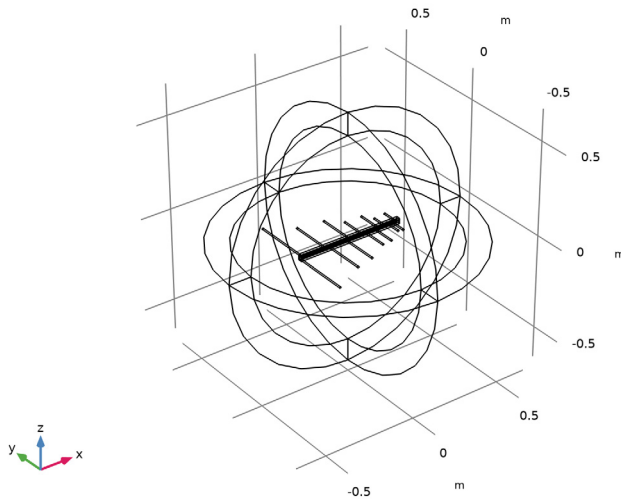

DEFINITIONS

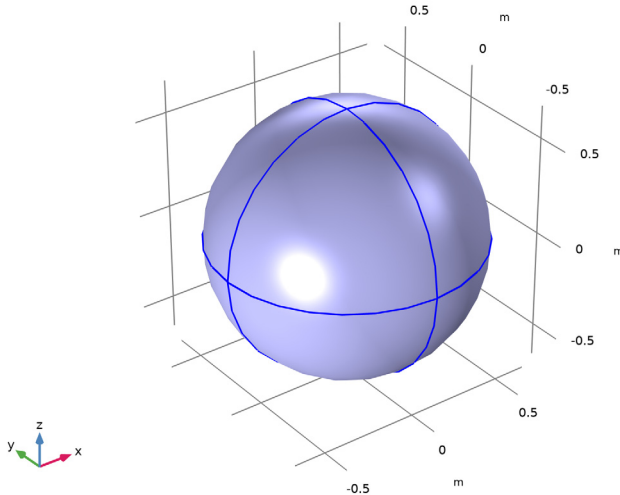

Perfectly Matched Layer 1 (pml1)

- 1 In the **Definitions** toolbar, click  **Perfectly Matched Layer**.
- 2 Select Domains 1–4 and 7–10 only.



- 3 In the **Settings** window for **Perfectly Matched Layer**, locate the **Geometry** section.
- 4 From the **Type** list, choose **Spherical**.

ADD MATERIAL

- 1 In the **Home** toolbar, click  **Add Material** to open the **Add Material** window.
- 2 Go to the **Add Material** window.
- 3 In the tree, select **Built-in>Air**.
- 4 Click **Add to Component** in the window toolbar.
- 5 In the **Home** toolbar, click  **Add Material** to close the **Add Material** window.

ELECTROMAGNETIC WAVES, FREQUENCY DOMAIN (EMW)



Lumped Port 1

- 1 In the **Model Builder** window, under **Component 1 (comp1)** right-click **Electromagnetic Waves, Frequency Domain (emw)** and choose **Lumped Port**.
- 2 In the **Settings** window for **Lumped Port**, locate the **Boundary Selection** section.

- 3 Click  **Paste Selection**.
- 4 In the **Paste Selection** dialog box, type 129 in the **Selection** text field.
- 5 Click **OK**.

For the first port, wave excitation is **on** by default.

Lumped Element 1

- 1 In the **Physics** toolbar, click  **Boundaries** and choose **Lumped Element**.
- 2 In the **Settings** window for **Lumped Element**, locate the **Boundary Selection** section.
- 3 Click  **Paste Selection**.
- 4 In the **Paste Selection** dialog box, type 20 in the **Selection** text field.
- 5 Click **OK**.
- 6 In the **Settings** window for **Lumped Element**, locate the **Settings** section.
- 7 In the Z_{element} text field, type `zstub`.

Far-Field Domain 1

In the **Physics** toolbar, click  **Domains** and choose **Far-Field Domain**.



MESH 1

- 1 In the **Model Builder** window, under **Component 1 (comp1)** click **Mesh 1**.
- 2 In the **Settings** window for **Mesh**, locate the **Physics-Controlled Mesh** section.
- 3 From the **Element size** list, choose **Extra coarse**.

We will now exclude the PML regions from the results visualization. For this purpose, create an explicit selection containing only that only contains domains 5 and 6 and store result values only in this selection.

DEFINITIONS

Results visualization

- 1 In the **Definitions** toolbar, click  **Explicit**.
- 2 In the **Settings** window for **Explicit**, type Results visualization in the **Label** text field.
- 3 Locate the **Input Entities** section. Click  **Paste Selection**.
- 4 In the **Paste Selection** dialog box, type 5 6 in the **Selection** text field.

5 Click **OK**.

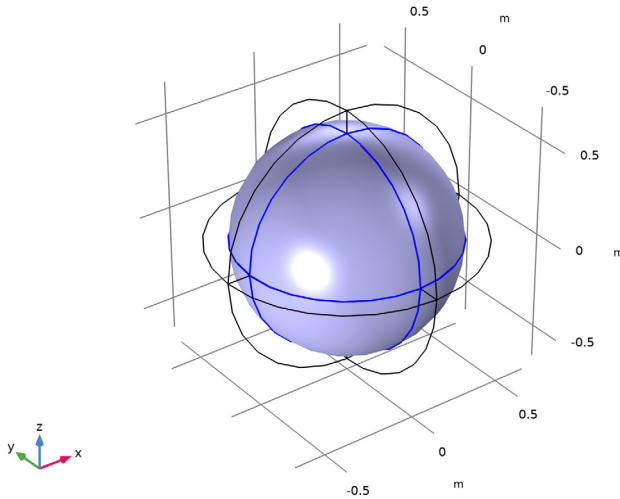

STUDY 1

Step 1: Frequency Domain



- 1 In the **Model Builder** window, under **Study 1** click **Step 1: Frequency Domain**.
- 2 In the **Settings** window for **Frequency Domain**, click to expand the **Values of Dependent Variables** section.
- 3 Find the **Store fields in output** subsection. From the **Settings** list, choose **For selections**.
- 4 Under **Selections**, click **+ Add**.
- 5 In the **Add** dialog box, select **Results visualization** in the **Selections** list.
- 6 Click **OK**.
- 7 In the **Home** toolbar, click **= Compute**.

RESULTS

Multislice

Replace the default expression for the electric field norm by a logarithmic expression. This gives better insights to the electric field distribution of the antenna.

- 1 In the **Model Builder** window, expand the **Electric Field (emw)** node, then click **Multislice**.
- 2 In the **Settings** window for **Multislice**, locate the **Expression** section.

- 3 In the **Expression** text field, type $20 \cdot \log_{10}(\text{emw.normE})$.
- 4 Locate the **Multipane Data** section. Find the **X-planes** subsection. In the **Planes** text field, type 0.
- 5 Find the **Y-planes** subsection. In the **Planes** text field, type 0.
- 6 Find the **Z-planes** subsection. From the **Entry method** list, choose **Coordinates**.
- 7 In the **Coordinates** text field, type 0.
- 8 Locate the **Coloring and Style** section. Click  **Change Color Table**.
- 9 In the **Color Table** dialog box, select **Thermal>HeatCamera** in the tree.
- 10 Click **OK**.
- 11 In the **Electric Field (emw)** toolbar, click  **Plot**.

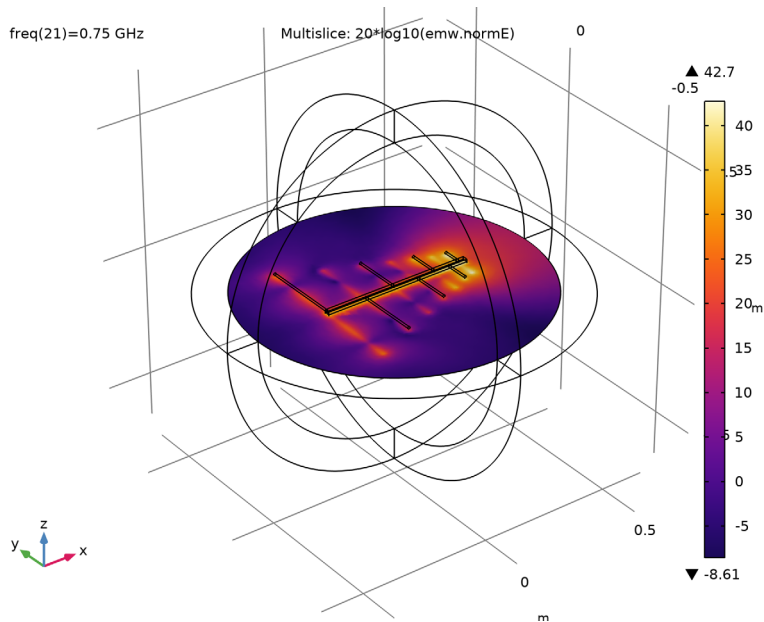

S-parameter (emw)

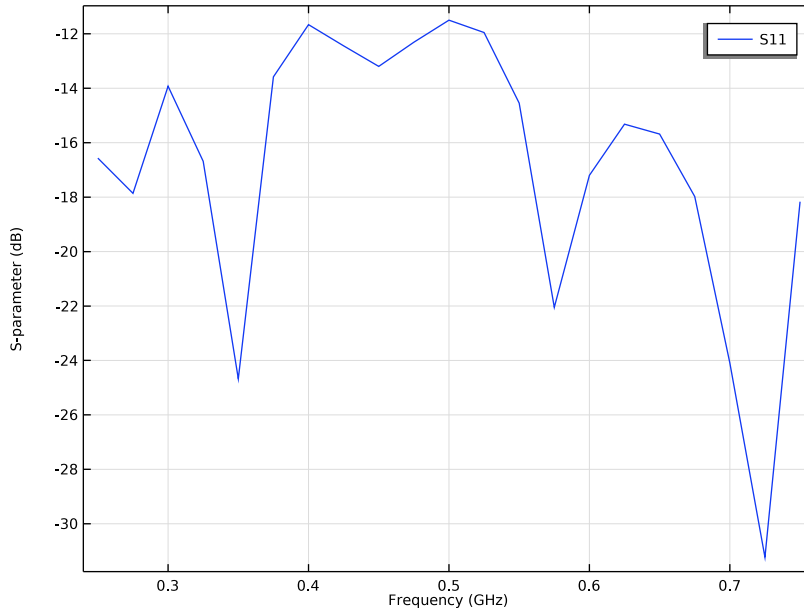

Smith Plot (emw)

Smith plot of the seven-element log-periodic antenna is shown in [Figure 2](#).

2D Far Field (emw)

Check [Figure 3](#) for far-field radiation patterns in a polar plot.

Radiation Pattern 1

[Figure 4](#) shows 3D far-field radiation pattern.

ID Plot Group 6

- 1 In the **Model Builder** window, expand the **3D Far Field, Gain (emw)** node.
- 2 Right-click **Results** and choose **ID Plot Group**.

Global 1

- 1 In the **Model Builder** window, right-click **ID Plot Group 6** and choose **Global**.
- 2 In the **Settings** window for **Global**, locate the **y-Axis Data** section.
- 3 In the table, enter the following settings:

Expression	Unit	Description
emw.VSWR_1	1	Voltage Standing Wave Ratio

4 In the **ID Plot Group 6** toolbar, click  **Plot**.

All computed VSWR values should be better than 2:1 (Figure 5).

3D Plot Group 7

In the **Home** toolbar, click  **Add Plot Group** and choose **3D Plot Group**.

Isosurface 1

- 1 Right-click **3D Plot Group 7** and choose **Isosurface**.
- 2 In the **Settings** window for **Isosurface**, locate the **Expression** section.
- 3 In the **Expression** text field, type $20 * \log(\text{emw}.\text{normE} + 0.01)$.
- 4 Locate the **Levels** section. In the **Total levels** text field, type 15.

Selection 1

- 1 Right-click **Isosurface 1** and choose **Selection**.
- 2 Select Domain 5 only.

Filter 1

- 1 In the **Model Builder** window, right-click **Isosurface 1** and choose **Filter**.
- 2 In the **Settings** window for **Filter**, locate the **Element Selection** section.
- 3 In the **Logical expression for inclusion** text field, type $z < 0$.

Isosurface 1

- 1 In the **Model Builder** window, click **Isosurface 1**.
- 2 In the **Settings** window for **Isosurface**, locate the **Coloring and Style** section.
- 3 Click  **Change Color Table**.
- 4 In the **Color Table** dialog box, select **Wave>Wave** in the tree.
- 5 Click **OK**.

