



Cascaded Rectangular Cavity Filter

Introduction

A cascaded cavity filter provides much better bandpass filter performance compared to a single cavity filter. Here, three rectangular cavity filters are coupled via slots and provide excellent out-of-band rejection.

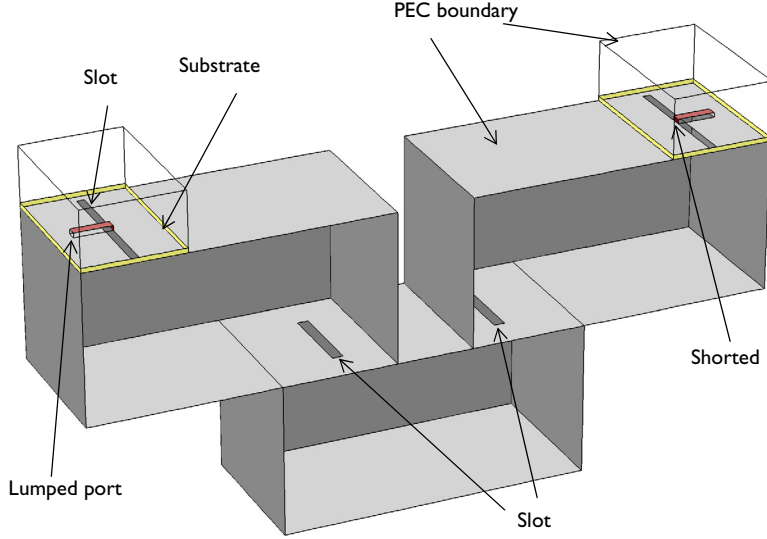

Figure 1: A cascaded rectangular cavity filter consisting of three cavities, coupling slots, and microstrip lines feeds.

Model Definition

The resonant frequencies of a rectangular cavity are given by

$$f_{nml} = \frac{c}{2\pi\sqrt{\epsilon_r\mu_r}} \sqrt{\left(\frac{m\pi}{a}\right)^2 + \left(\frac{n\pi}{b}\right)^2 + \left(\frac{l\pi}{d}\right)^2}$$

where a and b are the dimension of the aperture of a waveguide and d is the length of the waveguide cavity. The size of a single cavity used in this example is 50 mm, 50 mm, 100 mm in depth, height, and width, respectively. The resonant frequency at the dominant mode TE_{101} is 3.354 GHz. In this example, three such cavities are coupled through slots. The dimensions and locations of the slots can be adjusted to improve input matching properties as well as power transfer between in and output ports. Two shorted microstrip

lines, fed by a lumped port, couple into the first and last cavities of the structure. The air box around the microstrip lines is enclosed by metallic walls, representing the packaging.

Results and Discussion

Solving the model over a range of frequencies reveals that the resonant frequency of the cascaded filter is 3.354 GHz, as expected. The out-of-band rejection at ± 90 MHz is better than -60 dB.

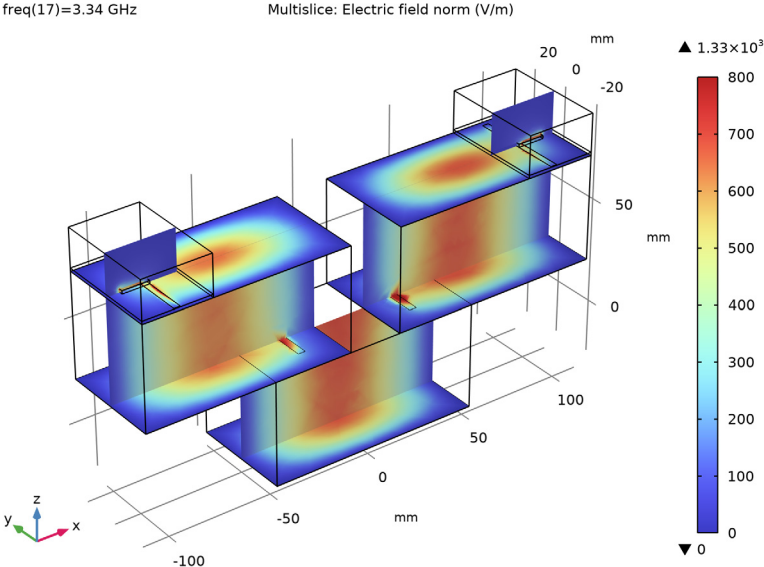

Figure 2: A plot of the electric field shows the dominant TE_{101} mode in each cavity.

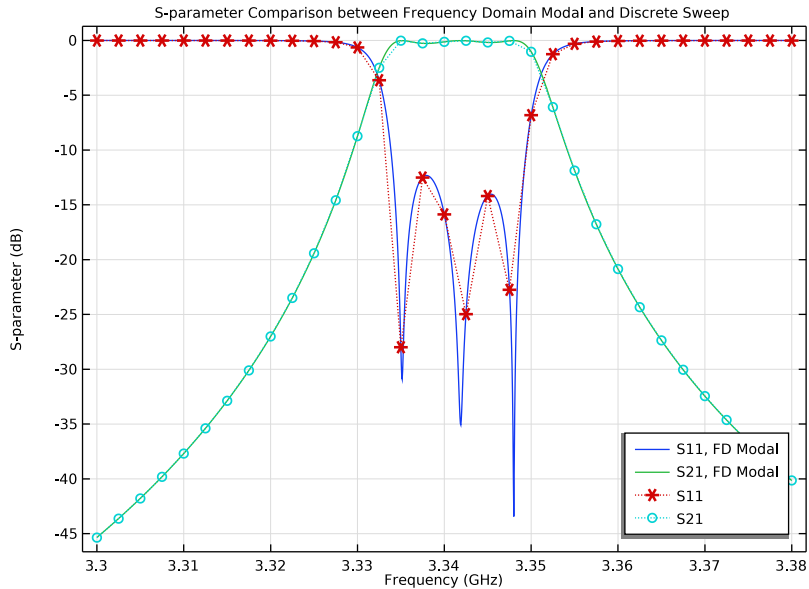

Figure 3: Frequency response of the cascaded rectangular cavity filter shows good bandpass characteristics.

Notes About the COMSOL Implementation

This example also uses the Frequency Domain Modal study step combined with an Eigenfrequency analysis to evaluate the frequency response of the filter circuit. This approach is faster than a regular frequency sweep performed in a Frequency Domain study, but its usage is limited to only high-Q devices or circuits presenting bandpass frequency properties excited by lumped ports. Since an Eigenfrequency analysis is computationally intensive, it may require more than 8 GB of RAM.

Reference

1. D.M. Pozar, *Microwave Engineering*, John Wiley & Sons, 1998.

Application Library path: RF_Module/Filters/cascaded_cavity_filter



Modeling Instructions

From the **File** menu, choose **New**.

NEW

In the **New** window, click  **Model Wizard**.

MODEL WIZARD

- 1 In the **Model Wizard** window, click  **3D**.
- 2 In the **Select Physics** tree, select **Radio Frequency>Electromagnetic Waves, Frequency Domain (emw)**.
- 3 Click **Add**.
- 4 Click  **Study**.
- 5 In the **Select Study** tree, select **General Studies>Frequency Domain**.
- 6 Click  **Done**.

STUDY I

Step 1: Frequency Domain

- 1 In the **Model Builder** window, under **Study I** click **Step 1: Frequency Domain**.
- 2 In the **Settings** window for **Frequency Domain**, locate the **Study Settings** section.
- 3 In the **Frequencies** text field, type range (3.3[GHz] , 2.5[MHz] , 3.38[GHz]).

GLOBAL DEFINITIONS

Parameters I

- 1 In the **Model Builder** window, under **Global Definitions** click **Parameters I**.
- 2 In the **Settings** window for **Parameters**, locate the **Parameters** section.
- 3 Click  **Load from File**.
- 4 Browse to the model's Application Libraries folder and double-click the file `cascaded_cavity_filter_parameters.txt`.



Here mil refers to the unit milliinch, that is 1 mil = 0.0254 mm.

GEOMETRY I

- 1 In the **Model Builder** window, under **Component 1 (comp1)** click **Geometry I**.
- 2 In the **Settings** window for **Geometry**, locate the **Units** section.
- 3 From the **Length unit** list, choose **mm**.



Create a cavity at the input port.

Cavity

- 1 In the **Geometry** toolbar, click  **Block**.
- 2 In the **Settings** window for **Block**, type Cavity1 in the **Label** text field.
- 3 Locate the **Size and Shape** section. In the **Width** text field, type w_cavity .
- 4 In the **Depth** text field, type d_cavity .
- 5 In the **Height** text field, type d_cavity .
- 6 Locate the **Position** section. From the **Base** list, choose **Center**.
- 7 In the **x** text field, type $-w_cavity/2-w_cavity/8$.
- 8 In the **z** text field, type d_cavity .
- 9 Click  **Build Selected**.

Create a substrate at the input port.

Substrate

- 1 In the **Geometry** toolbar, click  **Block**.
- 2 In the **Settings** window for **Block**, type Substrate in the **Label** text field.
- 3 Locate the **Size and Shape** section. In the **Width** text field, type $w_cavity/3$.
- 4 In the **Depth** text field, type d_cavity .
- 5 In the **Height** text field, type d .
- 6 Locate the **Position** section. In the **x** text field, type $-w_cavity-w_cavity/8$.
- 7 In the **y** text field, type $-w_cavity/4$.
- 8 In the **z** text field, type $d_cavity*1.5$.
- 9 Click  **Build Selected**.

Create a microstrip line at the input port.

Feed

- 1 In the **Geometry** toolbar, click  **Block**.
- 2 In the **Settings** window for **Block**, type Feed in the **Label** text field.
- 3 Locate the **Size and Shape** section. In the **Width** text field, type l_feed+w_slot .
- 4 In the **Depth** text field, type $3.2[\text{mm}]$.
- 5 In the **Height** text field, type d .
- 6 Locate the **Position** section. From the **Base** list, choose **Center**.
- 7 In the **x** text field, type $-w_cavity/2-w_cavity/8-x_slot-l_feed/2$.

8 In the **z** text field, type $d_cavity*1.5+d/2$.

9 Click  **Build Selected**.

To see the interior, you can choose wireframe rendering:

10 Click the  **Wireframe Rendering** button in the **Graphics** toolbar.

Create a box enclosing the input port.

FeedBoxBlock

1 In the **Geometry** toolbar, click  **Block**.

2 In the **Settings** window for **Block**, type FeedBoxBlock in the **Label** text field.

3 Locate the **Size and Shape** section. In the **Width** text field, type $w_cavity/3$.

4 In the **Depth** text field, type d_cavity .

5 In the **Height** text field, type h_feed .

6 Locate the **Position** section. From the **Base** list, choose **Center**.

7 In the **x** text field, type $-w_cavity-w_cavity/8+w_cavity/6$.

8 In the **z** text field, type $d_cavity*1.5+h_feed/2$.

9 Click  **Build Selected**.

Create coupling slots between the cavities.

Work Plane 1 (wp1)

1 In the **Geometry** toolbar, click  **Work Plane**.

2 In the **Settings** window for **Work Plane**, locate the **Plane Definition** section.

3 In the **z-coordinate** text field, type 25[mm].

4 Click  **Show Work Plane**.

Work Plane 1 (wp1)>Rectangle 1 (r1)

1 In the **Work Plane** toolbar, click  **Rectangle**.

2 In the **Settings** window for **Rectangle**, locate the **Size and Shape** section.

3 In the **Width** text field, type 3.5[mm].

4 In the **Height** text field, type 26.4[mm].

5 Locate the **Position** section. From the **Base** list, choose **Center**.

6 In the **xw** text field, type -28.5[mm].

7 Click  **Build Selected**.

Create coupling slots between the microstrip line feed and the cavity linked to the feed as well.

Work Plane 2 (wp2)

- 1 In the **Model Builder** window, right-click **Geometry 1** and choose **Work Plane**.
- 2 In the **Settings** window for **Work Plane**, locate the **Plane Definition** section.
- 3 In the **z-coordinate** text field, type 75[mm].
- 4 Click  **Show Work Plane**.

Work Plane 2 (wp2)>Rectangle 1 (r1)

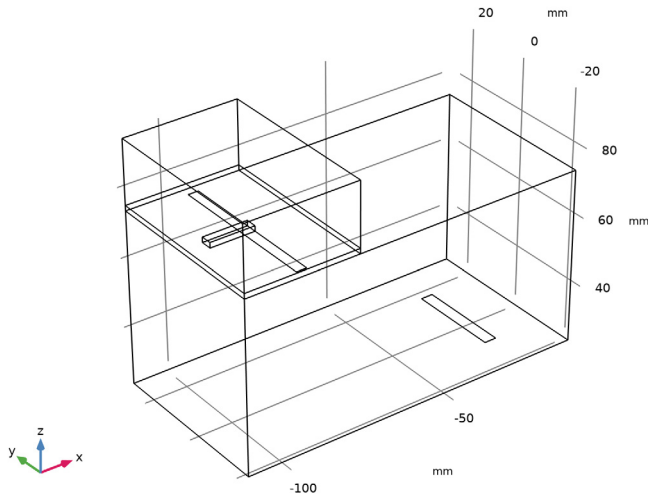

- 1 In the **Work Plane** toolbar, click  **Rectangle**.
- 2 In the **Settings** window for **Rectangle**, locate the **Size and Shape** section.
- 3 In the **Width** text field, type w_slot.
- 4 In the **Height** text field, type 45[mm].
- 5 Locate the **Position** section. From the **Base** list, choose **Center**.
- 6 In the **xw** text field, type -w_cavity/2-w_cavity/8-x_slot.
- 7 Right-click **Geometry 1** and choose **Build All**.



Generate the second cavity by mirroring the first one.

Mirror 1 (mir1)

- 1 In the **Geometry** toolbar, click  **Transforms** and choose **Mirror**.
- 2 Click in the **Graphics** window and then press Ctrl+A to select all objects.
- 3 In the **Settings** window for **Mirror**, locate the **Normal Vector to Plane of Reflection** section.

- 4 In the **x** text field, type 1.
- 5 In the **z** text field, type 0.
- 6 Locate the **Input** section. Select the **Keep input objects** check box.
- 7 Click  **Build All Objects**.
- 8 Click the  **Zoom Extents** button in the **Graphics** toolbar.

Cavity1.1 (blk5)

- 1 In the **Model Builder** window, under **Component 1 (comp1)>Geometry 1** right-click **Cavity1 (blk1)** and choose **Duplicate**.
- 2 In the **Settings** window for **Block**, locate the **Position** section.
- 3 In the **x** text field, type 0.
- 4 In the **z** text field, type 0.
- 5 Click  **Build All Objects**.

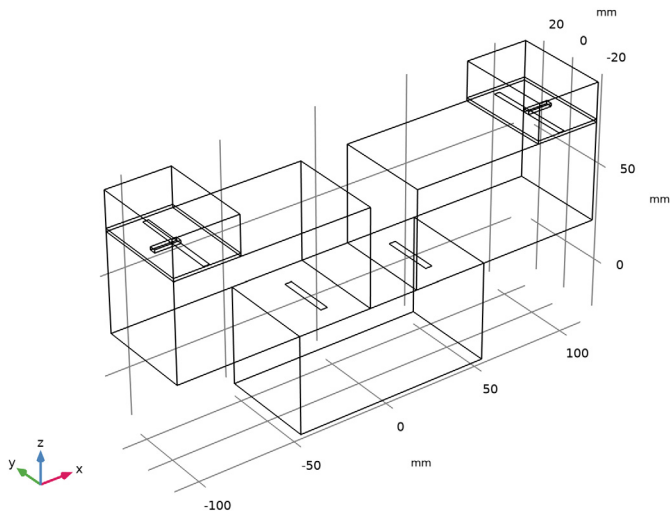

ELECTROMAGNETIC WAVES, FREQUENCY DOMAIN (EMW)

The default boundary condition is perfect electric conductor, which is applied to all exterior boundaries. Assign perfect electric conductor to interior boundaries on the cavity walls and microstrip lines.

Perfect Electric Conductor 2

- 1 In the **Model Builder** window, under **Component 1 (comp1)** right-click **Electromagnetic Waves, Frequency Domain (emw)** and choose the boundary condition **Perfect Electric Conductor**.
- 2 Select Boundaries 6, 16, 17, 22, 29, 36, 44, 52, 55, and 58 only.

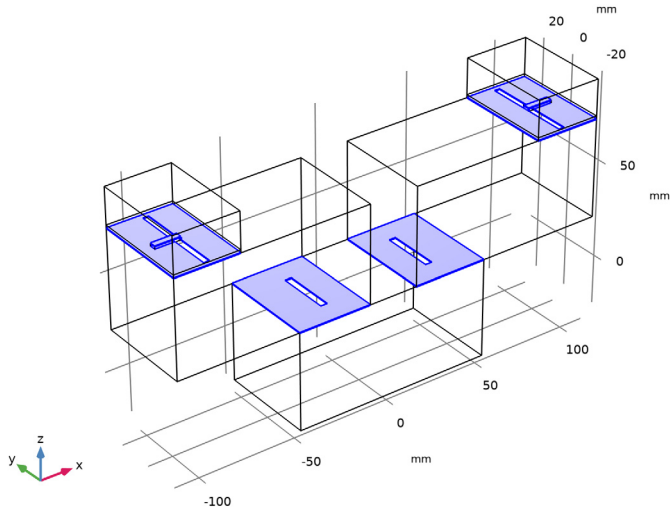

Assign a lumped port with port excitation at the end of one microstrip line.

Lumped Port 1

- 1 In the **Physics** toolbar, click  **Boundaries** and choose **Lumped Port**.
- 2 Select Boundary 14 only.

For the first port, wave excitation is **on** by default.

Assign a lumped port at the end of the other microstrip line.

Lumped Port 2

- 1 In the **Physics** toolbar, click  **Boundaries** and choose **Lumped Port**.
- 2 Select Boundary 59 only.

ADD MATERIAL

- 1 In the **Home** toolbar, click  **Add Material** to open the **Add Material** window.
- 2 Go to the **Add Material** window.
- 3 In the tree, select **Built-in>Air**.

4 Click **Add to Component** in the window toolbar.

5 In the **Home** toolbar, click  **Add Material** to close the **Add Material** window.

MATERIALS

Create a dielectric material for the substrates.

Material 2 (mat2)

1 In the **Model Builder** window, under **Component 1 (comp1)** right-click **Materials** and choose **Blank Material**.

2 Select Domains 2, 4, 7, and 9 only.

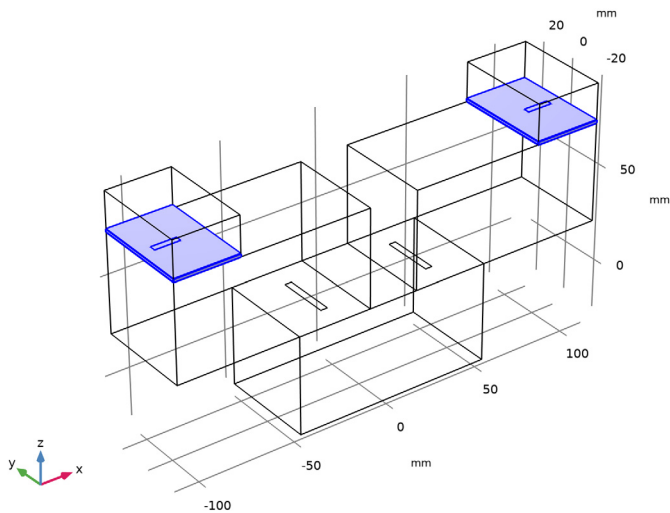

3 In the **Settings** window for **Material**, locate the **Material Contents** section.

4 In the table, enter the following settings:

Property	Variable	Value	Unit	Property group
Relative permittivity	epsilon _{nr_ii} ; epsilon _{nrii} = epsilon _{nr_ii} , epsilon _{nrij} = 0	3.38		Basic

Property	Variable	Value	Unit	Property group
Relative permeability	mur_iso ; murii = mur_iso, murij = 0	1		Basic
Electrical conductivity	sigma_iso ; sigmai = sigma_iso, sigmaj = 0	0	S/m	Basic

MESH I

- 1 In the **Model Builder** window, under **Component 1 (comp1)** click **Mesh 1**.
- 2 In the **Settings** window for **Mesh**, locate the **Physics-Controlled Mesh** section.
- 3 From the **Element size** list, choose **Fine**.
- 4 Click  **Build All**.

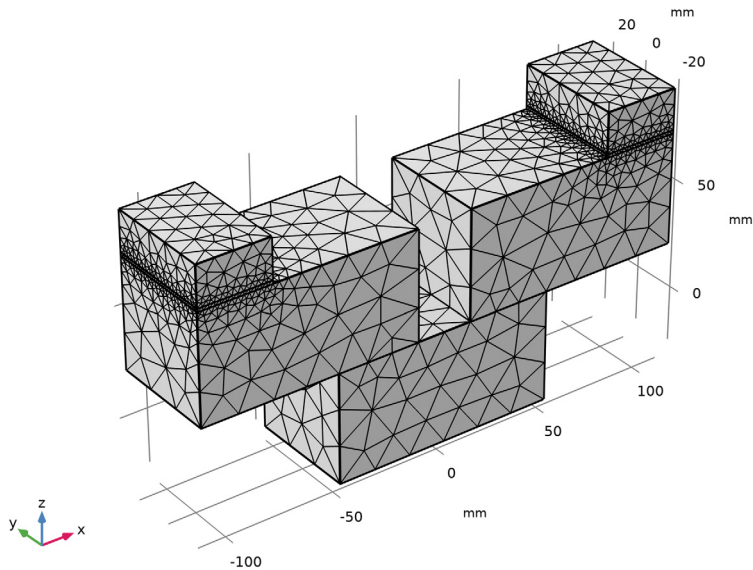

STUDY I

In the **Home** toolbar, click  **Compute**.

RESULTS

Electric Field (emw)

The default plot shows the norm of the electric field for the highest frequency. Follow the instructions to reproduce [Figure 2](#).

- 1 In the **Settings** window for **3D Plot Group**, locate the **Data** section.
- 2 From the **Parameter value (freq (GHz))** list, choose **3.34**.

Multislice

- 1 In the **Model Builder** window, expand the **Electric Field (emw)** node, then click **Multislice**.
- 2 In the **Settings** window for **Multislice**, locate the **Multipane Data** section.
- 3 Find the **X-planes** subsection. In the **Planes** text field, type 0.
- 4 Find the **Z-planes** subsection. From the **Entry method** list, choose **Coordinates**.
- 5 In the **Coordinates** text field, type $-d_cavity/2+0.1, d_cavity/2+0.1, d_cavity/2*3-0.1$.
- 6 Click to expand the **Range** section. Select the **Manual color range** check box.
- 7 In the **Maximum** text field, type 800.
- 8 In the **Electric Field (emw)** toolbar, click  **Plot**.

S-parameter (emw)

- 1 In the **Model Builder** window, under **Results** click **S-parameter (emw)**.
- 2 In the **Settings** window for **ID Plot Group**, locate the **Legend** section.

3 From the **Position** list, choose **Lower right**.

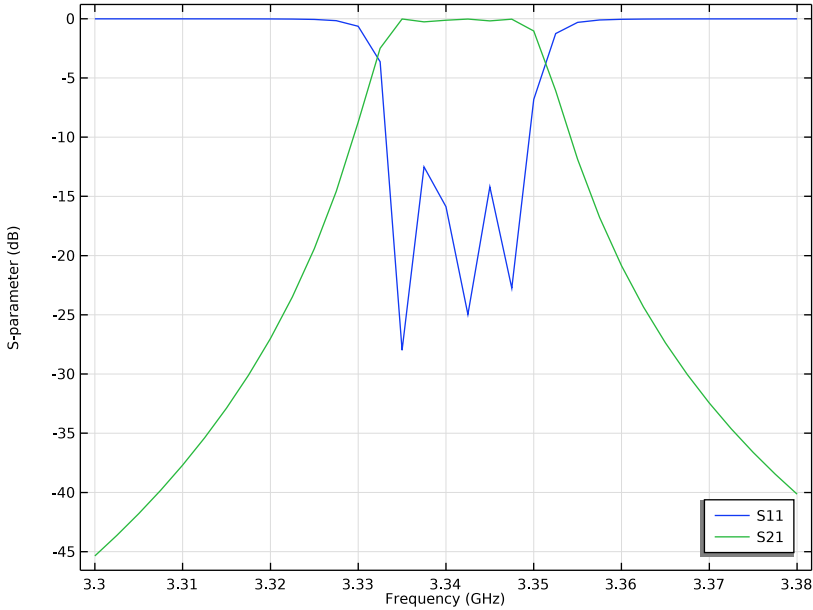

Smith Plot (emw)

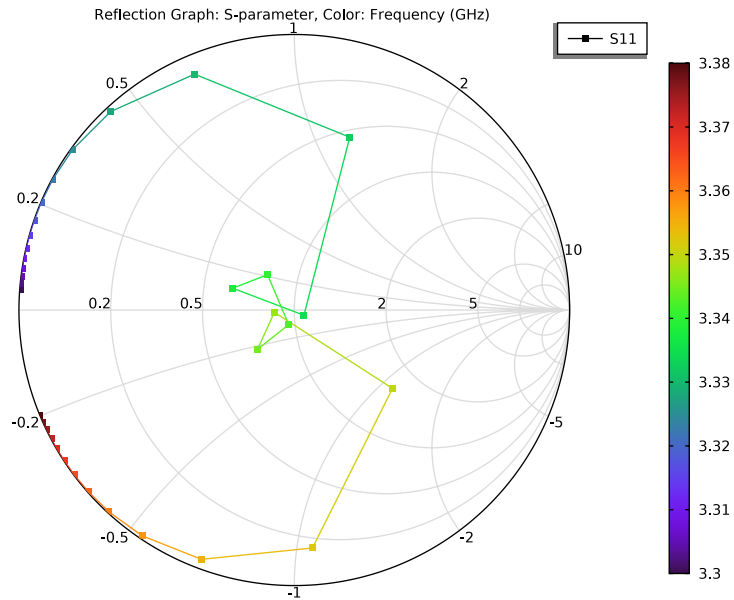

3D Plot Group 4

- 1 In the **Home** toolbar, click  **Add Plot Group** and choose **3D Plot Group**.
- 2 In the **Settings** window for **3D Plot Group**, locate the **Data** section.
- 3 From the **Parameter value (freq (GHz))** list, choose **3.34**.

Isosurface 1

- 1 Right-click **3D Plot Group 4** and choose **Isosurface**.
- 2 In the **Settings** window for **Isosurface**, locate the **Levels** section.
- 3 In the **Total levels** text field, type 20.
- 4 Locate the **Coloring and Style** section. Click  **Change Color Table**.
- 5 In the **Color Table** dialog box, select **Aurora>AuroraBorealis** in the tree.
- 6 Click **OK**.

Filter 1

- 1 Right-click **Isosurface 1** and choose **Filter**.
- 2 In the **Settings** window for **Filter**, locate the **Element Selection** section.
- 3 In the **Logical expression for inclusion** text field, type $y > 0$.

4 In the **3D Plot Group 4** toolbar, click  **Plot**.

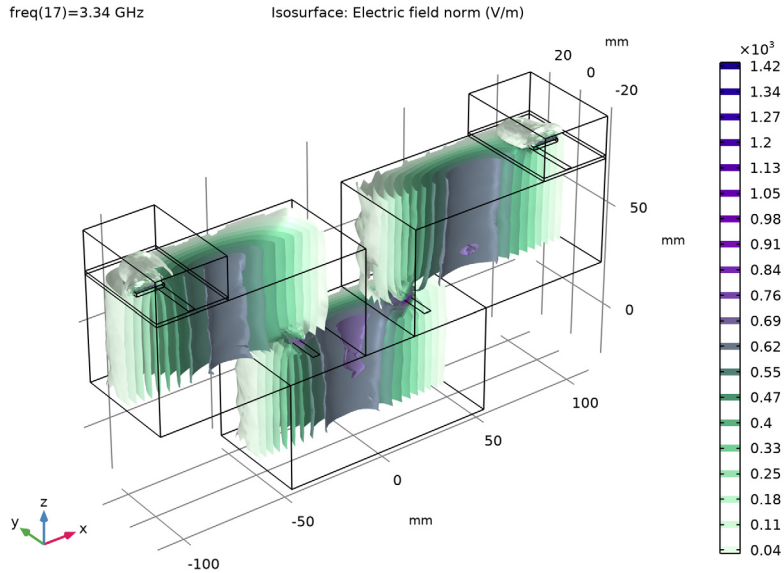

Analyze the same model with a Frequency Domain Modal method. When a device presents resonances, the Frequency Domain Modal method combined with an Eigenfrequency analysis provides a faster solution time.

ELECTROMAGNETIC WAVES, FREQUENCY DOMAIN (EMW)

Lumped Port 1



- 1 In the **Model Builder** window, under **Component 1 (comp1)**>**Electromagnetic Waves, Frequency Domain (emw)** click **Lumped Port 1**.
- 2 In the **Settings** window for **Lumped Port**, locate the **Boundary Selection** section.
- 3 Click  **Create Selection**.
- 4 In the **Create Selection** dialog box, Create a set of selections for use in the study settings.
- 5 type Lumped port 1 in the **Selection name** text field.
- 6 Click **OK**.

Lumped Port 2

- 1 In the **Model Builder** window, click **Lumped Port 2**.
- 2 In the **Settings** window for **Lumped Port**, locate the **Boundary Selection** section.

- 3 Click  **Create Selection**.
- 4 In the **Create Selection** dialog box, type Lumped port 2 in the **Selection name** text field.
- 5 Click **OK**.

ADD STUDY

- 1 In the **Home** toolbar, click  **Add Study** to open the **Add Study** window.
- 2 Go to the **Add Study** window.
- 3 Find the **Studies** subsection. In the **Select Study** tree, select **Preset Studies for Selected Physics Interfaces>Frequency Domain, Modal**.
- 4 Click **Add Study** in the window toolbar.
- 5 In the **Home** toolbar, click  **Add Study** to close the **Add Study** window.

STUDY 2

Step 1: Eigenfrequency

- 1 In the **Settings** window for **Eigenfrequency**, locate the **Study Settings** section.
- 2 In the **Search for eigenfrequencies around** text field, type 3.3[GHz].

Step 2: Frequency Domain, Modal

- 1 In the **Model Builder** window, click **Step 2: Frequency Domain, Modal**.
- 2 In the **Settings** window for **Frequency Domain, Modal**, locate the **Study Settings** section.
- 3 In the **Frequencies** text field, type range(3.3[GHz],2.5[MHz]/50,3.38[GHz]).

With a 50 times finer frequency step, the solutions will increase the file size tremendously when it is saved. When only S-parameters are of interest, a common theme in most passive RF and microwave device designs, it is not necessary to store all of the field solutions. By selecting the **Store fields in output** check box in the **Values of Dependent Variables** section, we can control the part of the model on which the computed solution is saved. We only add the selection containing these boundaries where the S-parameters are calculated. The lumped port size is typically very small compared to the entire modeling domain, and the saved file size with the finer frequency step is more or less that of the regular discrete frequency sweep model when only the solutions on the port boundaries are stored.

- 4 Click to expand the **Values of Dependent Variables** section. Find the **Store fields in output** subsection. From the **Settings** list, choose **For selections**.
- 5 Under **Selections**, click  **Add**.
- 6 In the **Add** dialog box, in the **Selections** list, choose **Lumped port 1** and **Lumped port 2**.

7 Click **OK**.

8 In the **Home** toolbar, click  **Compute**.

RESULTS

Electric Field (emw) 1

Since the results are stored only on the lumped port boundaries, this default E-field norm plot does not provide useful information.

1 Right-click **Results>Electric Field (emw) 1** and choose **Delete**.

Generate all S-parameters from each analysis on the same plot and compare them to each other.

S-parameter (emw) 1

1 In the **Model Builder** window, under **Results** click **S-parameter (emw) 1**.

2 In the **Settings** window for **ID Plot Group**, click to expand the **Title** section.

3 From the **Title type** list, choose **Manual**.

4 In the **Title** text area, type S-parameter Comparison between Frequency Domain Modal and Discrete Sweep.

5 Locate the **Legend** section. From the **Position** list, choose **Lower right**.

Global 2

1 In the **Model Builder** window, expand the **S-parameter (emw) 1** node.

2 Right-click **Results>S-parameter (emw) 1>Global 1** and choose **Duplicate**.

3 In the **Settings** window for **Global**, locate the **Data** section.

4 From the **Dataset** list, choose **Study 1/Solution 1 (sol1)**.

5 Click to expand the **Coloring and Style** section. Find the **Line style** subsection. From the **Line** list, choose **Dotted**.

6 Find the **Line markers** subsection. From the **Marker** list, choose **Cycle**.

Global 1

1 In the **Model Builder** window, click **Global 1**.

2 In the **Settings** window for **Global**, locate the **y-Axis Data** section.

3 In the table, enter the following settings:

Expression	Unit	Description
emw.S11dB	1	S11, FD Modal
emw.S21dB	1	S21, FD Modal

4 In the **S-parameter (emw) 1** toolbar, click  **Plot**.

See [Figure 3](#) for S-parameter plot.

Smith Plot (emw) 1

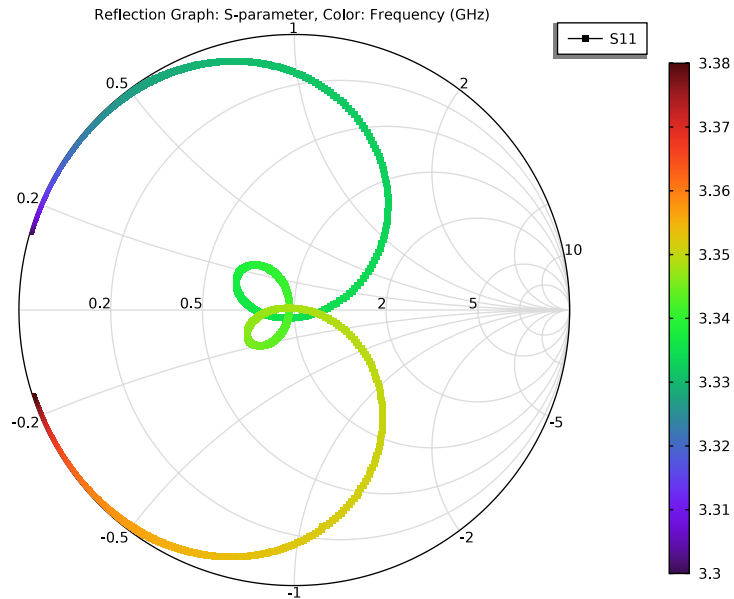

Compare the solution time between two studies.

The following instruction shows how to use the **Graph Marker** subfeature to analyze 1D plots. When plotting S_{11} of a bandpass filter, poles are of interest and a graph marker captures the local minima. For analyzing the insertion loss such as S_{21} , the -3dB bandwidth of the passband can be computed through an additional graph marker.

S-parameter with Graph Markers

- 1 In the **Home** toolbar, click  **Add Plot Group** and choose **1D Plot Group**.
- 2 In the **Settings** window for **1D Plot Group**, type S-parameter with Graph Markers in the **Label** text field.
- 3 Locate the **Data** section. From the **Dataset** list, choose **Study 2/Solution 2 (sol2)**.

Global 1

- 1 Right-click **S-parameter with Graph Markers** and choose **Global**.

- 2 In the **Settings** window for **Global**, click **Add Expression** in the upper-right corner of the **y-Axis Data** section. From the menu, choose **Component 1 (comp1)> Electromagnetic Waves, Frequency Domain>Ports>S-parameter, dB>emw.S11dB - S11**.
- 3 Locate the **y-Axis Data** section. In the table, enter the following settings:

Expression	Unit	Description
emw.S11dB	dB	S11

Graph Marker 1

- 1 Right-click **Global 1** and choose **Graph Marker**.
- 2 In the **Settings** window for **Graph Marker**, locate the **Display** section.
- 3 From the **Display** list, choose **Min**.
- 4 From the **Scope** list, choose **Local**.
- 5 Locate the **Text Format** section. In the **Display precision** text field, type 3.
- 6 Select the **Show x-coordinate** check box.
- 7 Select the **Include unit** check box.
- 8 Click to expand the **Coloring and Style** section. From the **Anchor point** list, choose **Lower left**.

Global 2

- 1 In the **Model Builder** window, right-click **S-parameter with Graph Markers** and choose **Global**.
- 2 In the **Settings** window for **Global**, click **Replace Expression** in the upper-right corner of the **y-Axis Data** section. From the menu, choose **Component 1 (comp1)> Electromagnetic Waves, Frequency Domain>Ports>S-parameter, dB>emw.S21dB - S21**.

Graph Marker 1

- 1 Right-click **Global 2** and choose **Graph Marker**.
- 2 In the **Settings** window for **Graph Marker**, locate the **Display** section.
- 3 From the **Display mode** list, choose **Bandwidth**.
- 4 Locate the **Text Format** section. In the **Display precision** text field, type 3.
- 5 Select the **Include unit** check box.

6 Locate the **Coloring and Style** section. Select the **Show frame** check box.

