



# Einzel Lens

## Introduction

---

An einzel lens is an electrostatic device used for focusing charged particle beams. It may be found in cathode ray tubes, ion beam and electron beam experiments, as well as in ion propulsion systems. This particular model consists of three axially aligned cylinders; the outer cylinders are grounded and the cylinder in the middle is held at a fixed voltage. The 3D electrostatic field is computed with the Electrostatics interface and the particle trajectories are computed using the Charged Particle Tracing interface.

## Model Definition

---

The focusing capability of an einzel lens depends on the initial particle energy, the voltage at each electrode, and the initial beam collimation (initial radius and transverse velocity of the charged particles).

The model geometry consists of three identical cylinders arranged on the same axis. The outer cylinders are grounded, and the middle cylinder has fixed voltage  $V_0 = -10$  kV. Note that this particular model uses cylinders, but other geometries are possible.

The electrons are released with an initial kinetic energy of 20 keV. The corresponding speed of the electrons is an appreciable fraction of the speed of light, so relativistic effects must be taken into account. The kinetic energy of a relativistic particle is

$$E = m_p c^2 - m_r c^2 \quad (1)$$

where  $c = 2.99792458 \times 10^8$  m/s is the speed of light in a vacuum,  $m_r$  (SI unit: kg) is the particle rest mass, and

$$m_p = \frac{m_r}{\sqrt{1 - \frac{|\mathbf{v}|^2}{c^2}}} \quad (2)$$

Substituting [Equation 2](#) into [Equation 1](#) and solving for the particle speed yields

$$|\mathbf{v}| = c \sqrt{1 - \frac{1}{\left(\frac{E}{m_r c^2} + 1\right)^2}} \quad (3)$$

For electrons, the rest mass is  $m_r = m_e = 9.10938356 \times 10^{-31}$  kg. Substituting  $m_r = m_e$  and  $E = 20$  keV into [Equation 3](#) yields a velocity magnitude of about  $0.27c$ , so the inclusion of the **Relativistic correction** term is justified.

This model uses two studies. First the electric potential is computed using a **Stationary** study. Then the corresponding electric field is used to exert an electric force on the model electrons using the **Electric Force** feature. The particle trajectories are computed using a **Time Dependent** study.

## Results and Discussion

The equipotential surfaces surrounding the electrodes are shown in [Figure 1](#). The electric potential and fringe fields in a cross section close to the electrodes are shown in [Figure 2](#).

The electron trajectories are plotted as lines in [Figure 3](#). The color is proportional to the particle kinetic energy and normalized to the initial kinetic energy of each particle. The particles decelerate as they approach the lens and then accelerate toward their initial speed as they pass through it. The nominal trajectory colored by hyperemittance, a common measurement the area occupied by a charged particle beam in transverse phase space, is shown in [Figure 4](#).

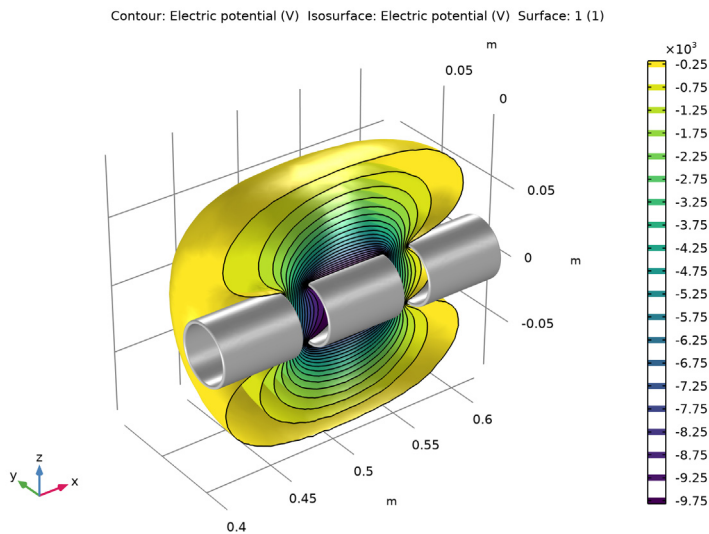

*Figure 1: Isosurfaces of electric potential in the vicinity of the electrodes.*

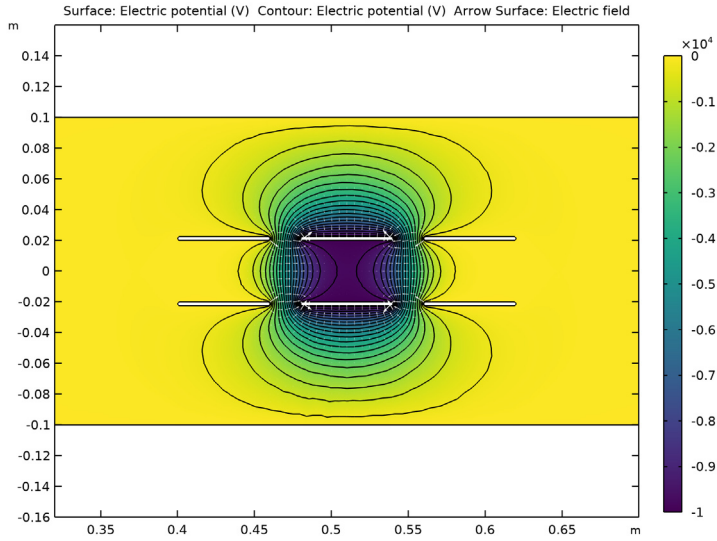

Figure 2: Electric potential and fringe fields in the vicinity of the electrodes.

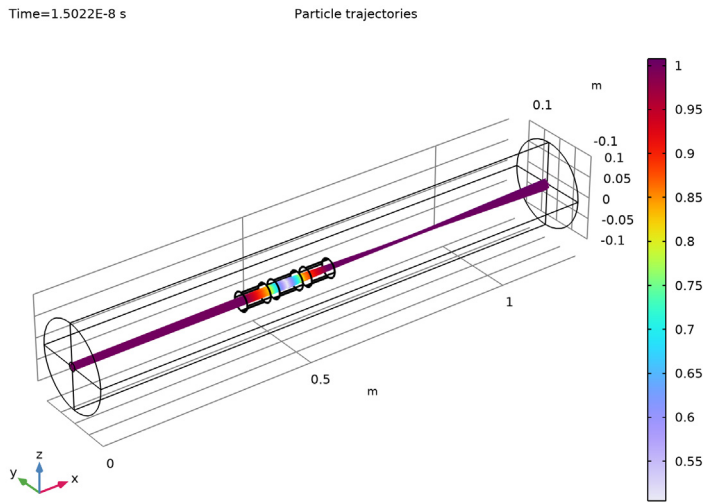

Figure 3: Electron trajectories in the einzel lens. The color expression indicates the ratio of the particle kinetic energy to the initial kinetic energy.

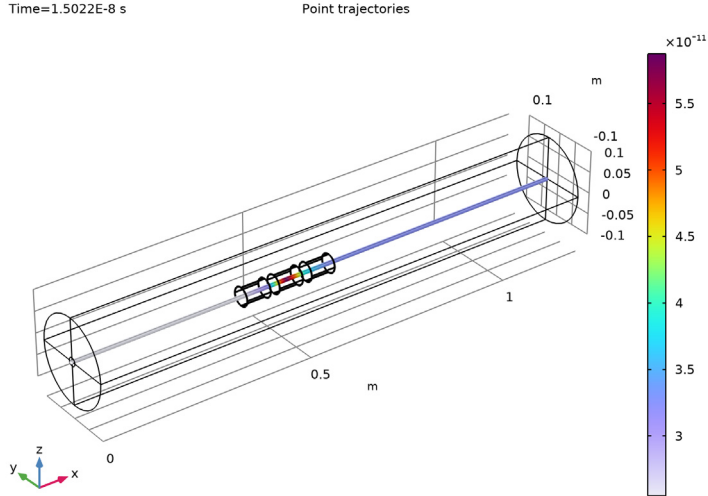

Figure 4: Nominal beam trajectory in the einzel lens. The color expression indicates the beam hyperemittance.

---

**Application Library path:** Particle\_Tracing\_Module/  
Charged\_Particle\_Tracing/einzel\_lens

---

### *Modeling Instructions*



---

From the **File** menu, choose **New**.

#### **NEW**

In the **New** window, click  **Model Wizard**.

#### **MODEL WIZARD**

- 1 In the **Model Wizard** window, click  **3D**.
- 2 In the **Select Physics** tree, select **AC/DC>Electric Fields and Currents>Electrostatics (es)**.
- 3 Click **Add**.
- 4 Click  **Study**.

5 In the **Select Study** tree, select **General Studies>Stationary**.

6 Click  **Done**.

## GLOBAL DEFINITIONS

### *Parameters I*

Load the model parameters from a file.

1 In the **Model Builder** window, under **Global Definitions** click **Parameters I**.

2 In the **Settings** window for **Parameters**, locate the **Parameters** section.

3 Click  **Load from File**.

4 Browse to the model's Application Libraries folder and double-click the file `einzel_lens_parameters.txt`.

## GEOMETRY I

Insert the prepared geometry sequence from file. You can read the instructions for creating the geometry in the appendix.

1 In the **Geometry** toolbar, click **Insert Sequence** and choose **Insert Sequence**.

2 Browse to the model's Application Libraries folder and double-click the file `einzel_lens_geom_sequence.mph`.

3 In the **Geometry** toolbar, click  **Build All**.

4 Click the  **Zoom Extents** button in the **Graphics** toolbar.

5 Click the  **Wireframe Rendering** button in the **Graphics** toolbar.

## DEFINITIONS

Create named selections for the electrodes. This will simplify the setup of the boundary conditions and mesh.

### *Ground Boundaries*

1 In the **Definitions** toolbar, click  **Explicit**.

2 In the **Settings** window for **Explicit**, type `Ground Boundaries` in the **Label** text field.

3 Select Domains 2 and 4 only.



4 Locate the **Output Entities** section. From the **Output entities** list, choose **Adjacent boundaries**.

### *Electrode Boundaries*

1 In the **Definitions** toolbar, click  **Explicit**.

- 2 In the **Settings** window for **Explicit**, type Electrode Boundaries in the **Label** text field.
- 3 Select Domain 3 only.
- 4 Locate the **Output Entities** section. From the **Output entities** list, choose **Adjacent boundaries**.

#### *All Cylinder Surfaces*

- 1 In the **Definitions** toolbar, click  **Union**.
- 2 In the **Settings** window for **Union**, type All Cylinder Surfaces in the **Label** text field.
- 3 Locate the **Geometric Entity Level** section. From the **Level** list, choose **Boundary**.
- 4 Locate the **Input Entities** section. Under **Selections to add**, click  **Add**.
- 5 In the **Add** dialog box, in the **Selections to add** list, choose **Ground Boundaries** and **Electrode Boundaries**.
- 6 Click **OK**.

### **ELECTROSTATICS (ES)**

- 1 In the **Model Builder** window, under **Component 1 (comp1)** click **Electrostatics (es)**.
- 2 In the **Settings** window for **Electrostatics**, locate the **Domain Selection** section.
- 3 Click  **Clear Selection**.
- 4 Select Domain 1 only. There is no need to solve for the electric potential in the other domains, which are inside the electrodes.

#### *Charge Conservation 1*

- 1 In the **Model Builder** window, under **Component 1 (comp1)>Electrostatics (es)** click **Charge Conservation 1**.
- 2 In the **Settings** window for **Charge Conservation**, locate the **Constitutive Relation D-E** section.
- 3 From the  $\epsilon_r$  list, choose **User defined**. Keep the default value for the vacuum relative permittivity.

#### *Grounded Vacuum Chamber Walls*

- 1 In the **Physics** toolbar, click  **Boundaries** and choose **Ground**.
- 2 In the **Settings** window for **Ground**, type Grounded Vacuum Chamber Walls in the **Label** text field.
- 3 Select Boundaries 3, 4, 8, and 13 only.

#### *Grounded Cylinders*

- 1 In the **Physics** toolbar, click  **Boundaries** and choose **Ground**.

- 2 In the **Settings** window for **Ground**, type Grounded Cylinders in the **Label** text field.
- 3 Locate the **Boundary Selection** section. From the **Selection** list, choose **Ground Boundaries**.

#### *Electric Potential I*

- 1 In the **Physics** toolbar, click  **Boundaries** and choose **Electric Potential**.
- 2 In the **Settings** window for **Electric Potential**, locate the **Boundary Selection** section.
- 3 From the **Selection** list, choose **Electrode Boundaries**.
- 4 Locate the **Electric Potential** section. In the  $V_0$  text field, type  $V_0$ .



#### **MESH I**

Since the focusing is accomplished via the fringe fields, it is important to solve for the electric potential near the cylinders accurately, so a finer mesh is used in that area.

#### *Size I*

- 1 In the **Model Builder** window, under **Component 1 (comp1)** right-click **Mesh 1** and choose **Size**.
- 2 In the **Settings** window for **Size**, locate the **Geometric Entity Selection** section.
- 3 From the **Geometric entity level** list, choose **Boundary**.
- 4 From the **Selection** list, choose **All Cylinder Surfaces**.
- 5 Locate the **Element Size** section. From the **Predefined** list, choose **Fine**.

#### *Free Tetrahedral I*

- 1 In the **Mesh** toolbar, click  **Free Tetrahedral**.
- 2 In the **Settings** window for **Free Tetrahedral**, locate the **Domain Selection** section.
- 3 From the **Geometric entity level** list, choose **Domain**.
- 4 Click  **Clear Selection**.
- 5 Select Domain 1 only.
- 6 Click  **Build All**.

#### **STUDY I**

- 1 In the **Model Builder** window, click **Study 1**.
- 2 In the **Settings** window for **Study**, locate the **Study Settings** section.
- 3 Clear the **Generate default plots** check box.
- 4 In the **Home** toolbar, click  **Compute**.



## RESULTS

### *Cut Plane: $y=0$*

- 1 In the **Model Builder** window, expand the **Results** node.
- 2 Right-click **Results>Datasets** and choose **Cut Plane**.
- 3 In the **Settings** window for **Cut Plane**, type Cut Plane:  $y=0$  in the **Label** text field.
- 4 Locate the **Plane Data** section. From the **Plane** list, choose **xz-planes**.

### *Equipotential Surfaces*

- 1 In the **Results** toolbar, click  **3D Plot Group**.
- 2 In the **Settings** window for **3D Plot Group**, type Equipotential Surfaces in the **Label** text field.
- 3 Locate the **Plot Settings** section. Clear the **Plot dataset edges** check box.

### *Contour 1*

- 1 Right-click **Equipotential Surfaces** and choose **Contour**.
- 2 In the **Settings** window for **Contour**, locate the **Data** section.
- 3 From the **Dataset** list, choose **Cut Plane:  $y=0$** .
- 4 Locate the **Coloring and Style** section. From the **Coloring** list, choose **Uniform**.
- 5 From the **Color** list, choose **Black**.
- 6 Clear the **Color legend** check box.

### *Isosurface 1*

- 1 In the **Model Builder** window, right-click **Equipotential Surfaces** and choose **Isosurface**.
- 2 In the **Settings** window for **Isosurface**, locate the **Levels** section.
- 3 In the **Total levels** text field, type 20.
- 4 Locate the **Coloring and Style** section. Click  **Change Color Table**.
- 5 In the **Color Table** dialog box, select **Linear>Viridis** in the tree.
- 6 Click **OK**.

### *Filter 1*

Use a **Filter** to see a cross section of the equipotential surfaces. Otherwise, only the outermost surface is shown.

- 1 Right-click **Isosurface 1** and choose **Filter**.
- 2 In the **Settings** window for **Filter**, locate the **Element Selection** section.
- 3 In the **Logical expression for inclusion** text field, type  $y>0$ .



### *Equipotential Surfaces*

Next, color the electrode surfaces gray.

#### *Surface 1*

- 1 In the **Model Builder** window, right-click **Equipotential Surfaces** and choose **Surface**.
- 2 In the **Settings** window for **Surface**, locate the **Expression** section.
- 3 In the **Expression** text field, type 1.
- 4 Locate the **Coloring and Style** section. From the **Coloring** list, choose **Uniform**.
- 5 From the **Color** list, choose **Gray**.

#### *Selection 1*

- 1 Right-click **Surface 1** and choose **Selection**.
- 2 In the **Settings** window for **Selection**, locate the **Selection** section.
- 3 From the **Selection** list, choose **All Cylinder Surfaces**.
- 4 In the **Equipotential Surfaces** toolbar, click  **Plot**.
- 5 Click the  **Go to Default View** button in the **Graphics** toolbar. Compare the resulting plot to [Figure 1](#).

#### *Fringe Field*

- 1 In the **Home** toolbar, click  **Add Plot Group** and choose **2D Plot Group**.
- 2 In the **Settings** window for **2D Plot Group**, type Fringe Field in the **Label** text field.



#### *Surface 1*

- 1 Right-click **Fringe Field** and choose **Surface**.  
By default a surface plot of the electric potential in the cut plane is shown.
- 2 In the **Settings** window for **Surface**, locate the **Coloring and Style** section.
- 3 Click  **Change Color Table**.
- 4 In the **Color Table** dialog box, select **Linear>Viridis** in the tree.
- 5 Click **OK**.

#### *Contour 1*

- 1 In the **Model Builder** window, right-click **Fringe Field** and choose **Contour**.
- 2 In the **Settings** window for **Contour**, locate the **Coloring and Style** section.
- 3 From the **Coloring** list, choose **Uniform**.
- 4 From the **Color** list, choose **Black**.
- 5 Clear the **Color legend** check box.

### *Arrow Surface 1*



- 1 Right-click **Fringe Field** and choose **Arrow Surface**.
- 2 In the **Settings** window for **Arrow Surface**, locate the **Arrow Positioning** section.
- 3 Find the **x grid points** subsection. From the **Entry method** list, choose **Coordinates**.
- 4 Click  **Range**.
- 5 In the **Range** dialog box, type 0.42 in the **Start** text field.
- 6 In the **Step** text field, type 0.0050.
- 7 In the **Stop** text field, type 0.6.
- 8 Click **Add**.
- 9 In the **Settings** window for **Arrow Surface**, locate the **Arrow Positioning** section.
- 10 Find the **y grid points** subsection. From the **Entry method** list, choose **Coordinates**.
- 11 Click  **Range**.
- 12 In the **Range** dialog box, type -0.095 in the **Start** text field.
- 13 In the **Step** text field, type 0.005.
- 14 In the **Stop** text field, type 0.095.
- 15 Click **Add**.
- 16 In the **Settings** window for **Arrow Surface**, locate the **Coloring and Style** section.
- 17 From the **Color** list, choose **White**.
- 18 Use the **Zoom Box** button to see the details around the electrodes more clearly.

### *Fringe Field*



- 1 In the **Model Builder** window, click **Fringe Field**.
- 2 In the **Fringe Field** toolbar, click  **Plot**. Compare the resulting plot to [Figure 2](#).

Now that the field has been computed, model the propagation of an electron beam through the einzel lens.

### **ADD PHYSICS**

- 1 In the **Home** toolbar, click  **Add Physics** to open the **Add Physics** window.
- 2 Go to the **Add Physics** window.
- 3 In the tree, select **AC/DC>Particle Tracing>Charged Particle Tracing (cpt)**.
- 4 Find the **Physics interfaces in study** subsection. Clear the check box next to **Study 1**.
- 5 Click **Add to Component 1** in the window toolbar.
- 6 In the **Home** toolbar, click  **Add Physics** to close the **Add Physics** window.

## CHARGED PARTICLE TRACING (CPT)

- 1 Click the  **Zoom Extents** button in the **Graphics** toolbar to see the entire geometry.
- 2 In the **Settings** window for **Charged Particle Tracing**, locate the **Domain Selection** section.
- 3 Click  **Clear Selection**.
- 4 Select Domain 1 only. When the electrode domains are removed from the physics interface selection, the default **Wall** condition applies to the adjacent boundaries and prevents electrons from passing through the excluded domains.
- 5 Locate the **Particle Release and Propagation** section. Select the **Relativistic correction** check box.

### *Electric Force I*

- 1 Right-click **Component I (comp1)>Charged Particle Tracing (cpt)** and choose **Electric Force**.
- 2 In the **Settings** window for **Electric Force**, locate the **Domain Selection** section.
- 3 From the **Selection** list, choose **All domains**.
- 4 Locate the **Electric Force** section. From the **E** list, choose **Electric field (es/ccn1)**.
- 5 Locate the **Advanced Settings** section. Select the **Use piecewise polynomial recovery on field** check box.

### *Particle Beam I*

- 1 In the **Physics** toolbar, click  **Boundaries** and choose **Particle Beam**.
  - 2 Select Boundaries 5, 6, 9, and 10 only.
  - 3 In the **Settings** window for **Particle Beam**, locate the **Initial Transverse Velocity** section.
  - 4 In the  $\epsilon_{\text{rms}}$  text field, type 5[um].
  - 5 Locate the **Initial Longitudinal Velocity** section. In the  $E$  text field, type E0.
- Add a **Time Dependent** study to compute the electron trajectories over time.

## ADD STUDY

- 1 In the **Home** toolbar, click  **Add Study** to open the **Add Study** window.
- 2 Go to the **Add Study** window.
- 3 Find the **Studies** subsection. In the **Select Study** tree, select **General Studies>Time Dependent**.
- 4 Find the **Physics interfaces in study** subsection. Clear the check box next to the **Electrostatics (es)** interface, which will not be solved for again.
- 5 Click **Add Study** in the window toolbar.

- 6 In the **Home** toolbar, click  **Add Study** to close the **Add Study** window.

## STUDY 2

### *Step 1: Time Dependent*



- 1 In the **Settings** window for **Time Dependent**, locate the **Study Settings** section.
- 2 In the **Output times** text field, type range (0, T/20, T\*1.05).  
Manually select the solution from the **Stationary** study in order to get the electric field computed by the Electrostatics interface.
- 3 Click to expand the **Values of Dependent Variables** section. Find the **Values of variables not solved for** subsection. From the **Settings** list, choose **User controlled**.
- 4 From the **Method** list, choose **Solution**.
- 5 From the **Study** list, choose **Study 1, Stationary**.
- 6 In the **Home** toolbar, click  **Compute**.

## RESULTS

### *Particle Trajectories 1*

- 1 In the **Model Builder** window, expand the **Particle Trajectories (cpt)** node, then click **Particle Trajectories 1**.
- 2 In the **Settings** window for **Particle Trajectories**, locate the **Coloring and Style** section.
- 3 Find the **Line style** subsection. From the **Type** list, choose **Line**.
- 4 Find the **Point style** subsection. From the **Type** list, choose **None**.

### *Color Expression 1*



- 1 In the **Model Builder** window, expand the **Particle Trajectories 1** node, then click **Color Expression 1**.
- 2 In the **Settings** window for **Color Expression**, locate the **Expression** section.
- 3 In the **Expression** text field, type  $\text{cpt} . \text{Ep} / \text{E0}$ .
- 4 Locate the **Coloring and Style** section. Click  **Change Color Table**.
- 5 In the **Color Table** dialog box, select **Rainbow>Prism** in the tree.
- 6 Click **OK**.
- 7 In the **Particle Trajectories (cpt)** toolbar, click  **Plot**. Compare the resulting plot to [Figure 3](#).

### *Point Trajectories I*

- 1 In the **Model Builder** window, expand the **Average Beam Position (cpt)** node, then click **Point Trajectories I**.
- 2 In the **Settings** window for **Point Trajectories**, locate the **Coloring and Style** section.
- 3 Find the **Line style** subsection. From the **Type** list, choose **Tube**.

### *Color Expression I*

By default the 1-RMS hyperemittance is used as the color expression along the nominal beam trajectory.

- 1 In the **Model Builder** window, expand the **Point Trajectories I** node, then click **Color Expression I**.
- 2 In the **Settings** window for **Color Expression**, locate the **Coloring and Style** section.
- 3 Click  **Change Color Table**.
- 4 In the **Color Table** dialog box, select **Rainbow>Prism** in the tree.
- 5 Click **OK**.
- 6 In the **Average Beam Position (cpt)** toolbar, click  **Plot**. Compare the resulting plot to [Figure 4](#).

## *Appendix — Geometry Instructions*

---

### **GLOBAL DEFINITIONS**

#### *Parameters I*

Load the geometry parameters from a file.

- 1 In the **Model Builder** window, under **Global Definitions** click **Parameters I**.
- 2 In the **Settings** window for **Parameters**, locate the **Parameters** section.
- 3 Click  **Load from File**.
- 4 Browse to the model's Application Libraries folder and double-click the file `einzel_lens_geom_sequence_parameters.txt`.

### **GEOMETRY I**

#### *Work Plane I (wp1)*

- 1 In the **Geometry** toolbar, click  **Work Plane**.
- 2 In the **Settings** window for **Work Plane**, locate the **Plane Definition** section.
- 3 From the **Plane** list, choose **zx-plane**.

*Work Plane 1 (wp1)>Plane Geometry*

In the **Model Builder** window, click **Plane Geometry**.

*Work Plane 1 (wp1)>Rectangle 1 (r1)*

- 1 In the **Work Plane** toolbar, click  **Rectangle**.
- 2 In the **Settings** window for **Rectangle**, locate the **Size and Shape** section.
- 3 In the **Width** text field, type T\_cyl.
- 4 In the **Height** text field, type L\_cyl.
- 5 Locate the **Position** section. In the **xw** text field, type R\_cyl.
- 6 In the **yw** text field, type d\_lens.

*Work Plane 1 (wp1)>Fillet 1 (fil1)*

- 1 In the **Work Plane** toolbar, click  **Fillet**.
- 2 On the object **r1**, select Points 1–4 only.
- 3 In the **Settings** window for **Fillet**, locate the **Radius** section.
- 4 In the **Radius** text field, type R\_cyl\_fil.

*Work Plane 1 (wp1)>Array 1 (arr1)*

- 1 In the **Work Plane** toolbar, click  **Transforms** and choose **Array**.
- 2 Select the object **fil1** only.
- 3 In the **Settings** window for **Array**, locate the **Size** section.
- 4 In the **yw size** text field, type 3.
- 5 Locate the **Displacement** section. In the **yw** text field, type L\_cyl + cyl\_sep.

*Work Plane 1 (wp1)>Rectangle 2 (r2)*

- 1 In the **Work Plane** toolbar, click  **Rectangle**.
- 2 In the **Settings** window for **Rectangle**, locate the **Size and Shape** section.
- 3 In the **Width** text field, type R\_vac.
- 4 In the **Height** text field, type L\_vac.

*Work Plane 1 (wp1)>Point 1 (pt1)*

- 1 In the **Work Plane** toolbar, click  **Point**.
- 2 In the **Settings** window for **Point**, locate the **Point** section.
- 3 In the **xw** text field, type initial\_beam\_radius.

*Revolve 1 (rev1)*

- 1 In the **Model Builder** window, right-click **Geometry 1** and choose **Revolve**.

2 In the **Settings** window for **Revolve**, click  **Build All Objects**.