



# Thermal Actuator — Parameterized

## Introduction

---

This example model consists of a two-hot-arm thermal actuator made of polysilicon. The actuator is activated through thermal expansion. The temperature increase required to deform the two hot arms, and thus displace the actuator, is obtained through Joule heating (resistive heating). The greater expansion of the hot arms, compared to the cold arm, causes a bending of the actuator. In an actual device, a wide range of electrical resistance values is possible through doping of the polysilicon material.

The actuator's operation thus involves three coupled physics phenomena: electric current conduction, heat conduction with heat generation, and structural stresses and strains due to thermal expansion.

## Model Definition

---

Figure 1 shows the actuator's parts and dimensions as well as its position on top of a substrate surface.

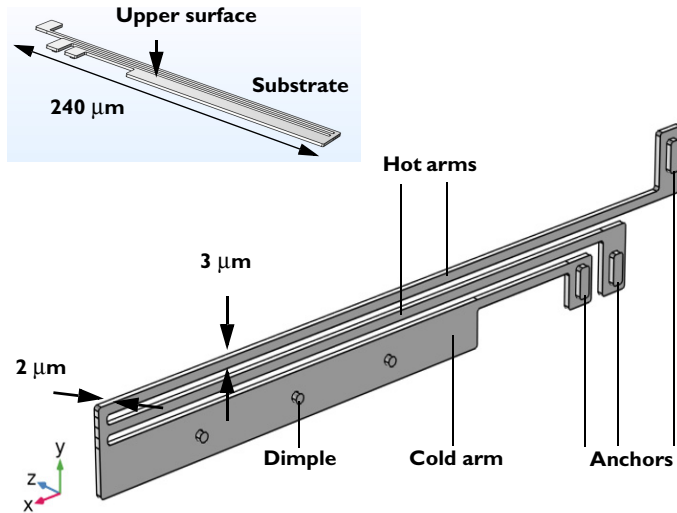

Figure 1: The thermal microactuator.

## BOUNDARY CONDITIONS AND CONSTRAINTS

An electric potential is applied between the bases of the hot arms' anchors. The cold arm anchor and all other surfaces are electrically insulated.

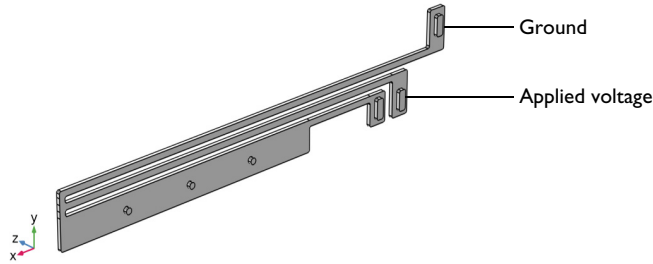

Figure 2: Electrical boundary conditions.

The temperature of the base of the three anchors and the three dimples is fixed to that of the substrate's constant temperature. Because the structure is sandwiched, all other boundaries interact thermally with the surroundings by conduction through thin layers of air. This can be implemented as thermal contact conditions or as a convective heat flux condition, where the heat flux coefficient represent one over the thermal resistance. In this model we chose to use a heat flux condition. The heat-transfer coefficient is given by the thermal conductivity of air divided by the distance to the surrounding surfaces for the system. This exercise uses different heat-transfer coefficients for the actuator's upper and other surfaces.

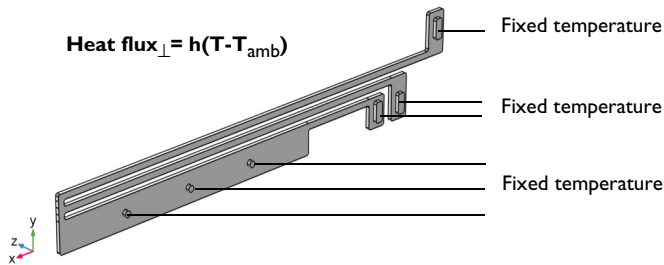

Figure 3: Heat-transfer boundary conditions.

All three arms are mechanically fixed at the base of the three anchors. The dimples can move freely in the plane of the substrate (the  $xy$ -plane in the figure) but do not move in the direction perpendicular to the substrate (the  $z$  direction).

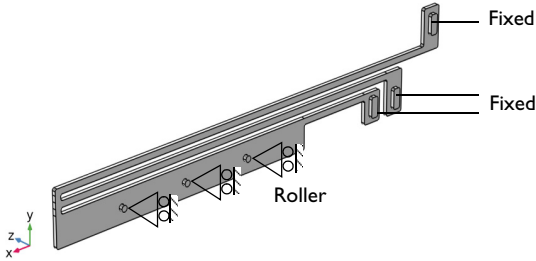

Figure 4: Structural boundary conditions and constraints.

Results

Figure 5 shows the surface temperature distribution for the actuator. Figure 6 illustrates the displacement field through color and deformation plot.

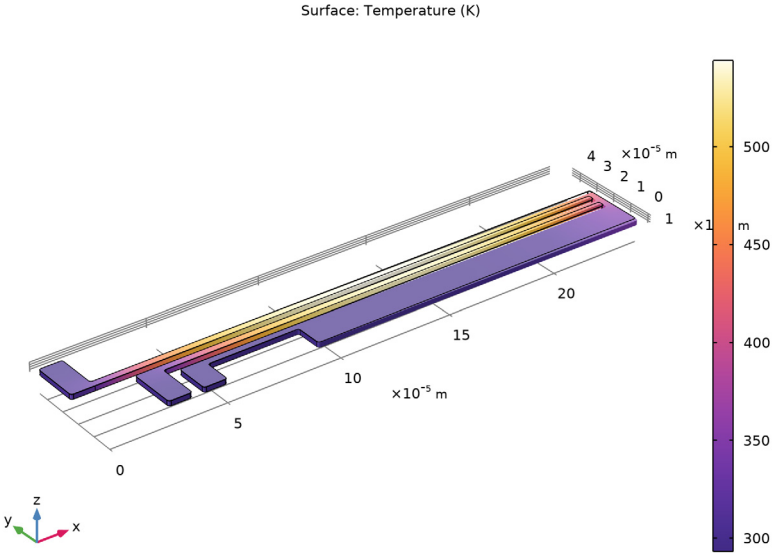

Figure 5: Temperature plot.

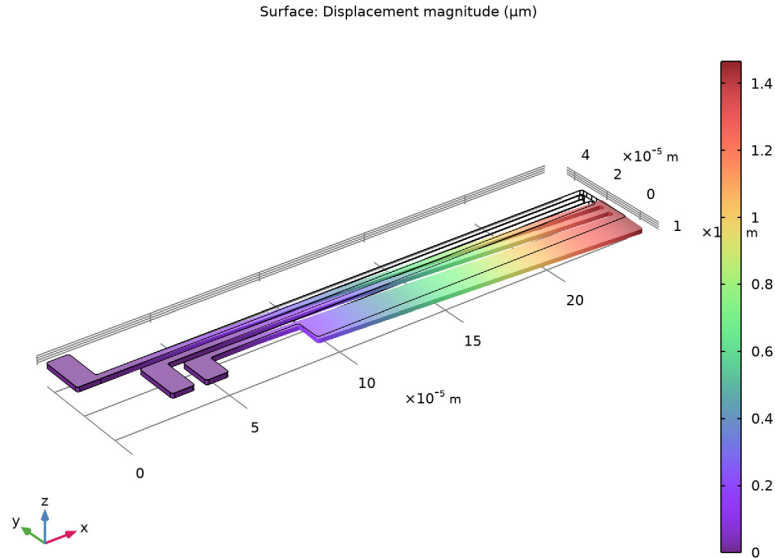

Figure 6: Displacement in the thermal actuator.

### Reference

I. D.M. Burns and V.M. Bright, “Design and performance of a double hot arm polysilicon thermal actuator,” *Proc. SPIE 3224, Micromachined Devices and Components III*, 1997; doi: [10.1117/12.284528](https://doi.org/10.1117/12.284528).

**Application Library path:** MEMS\_Module/Actuators/  
thermal\_actuator\_tem\_parameterized



### Modeling Instructions

From the **File** menu, choose **New**.

#### NEW

In the **New** window, click  **Model Wizard**.

## MODEL WIZARD

- 1 In the **Model Wizard** window, click  **3D**.
- 2 In the **Select Physics** tree, select **Structural Mechanics>Thermal-Structure Interaction>Joule Heating and Thermal Expansion**.
- 3 Click **Add**.
- 4 Click  **Study**.
- 5 In the **Select Study** tree, select **General Studies>Stationary**.
- 6 Click  **Done**.

## THERMAL ACTUATOR

- 1 In the **Model Builder** window, right-click **Component 1 (comp1)** and choose **Rename**.
- 2 In the **Rename Component** dialog box, type Thermal Actuator in the **New label** text field.
- 3 Click **OK**.

## GLOBAL DEFINITIONS

### *Parameters 1*



- 1 In the **Model Builder** window, under **Global Definitions** click **Parameters 1**.
- 2 In the **Settings** window for **Parameters**, locate the **Parameters** section.
- 3 In the table, enter the following settings:

Name	Expression	Value	Description
d	3[um]	3E-6 m	Height of the hot arm
dw	15[um]	1.5E-5 m	Height of the cold arm
gap	3[um]	3E-6 m	Gap between arms
wb	10[um]	1E-5 m	Width of the base
wv	25[um]	2.5E-5 m	Difference in length between hot arms
L	240[um]	2.4E-4 m	Actuator length
L1	L-wb	2.3E-4 m	Length of the longest hot arm
L2	L-wb-wv	2.05E-4 m	Length of the shortest hot arm



Name	Expression	Value	Description
L3	$L - 2 * w_b - w_v - L / 48 - L / 6$	1.5E-4 m	Length of the cold arm, thick part
L4	$L / 6$	4E-5 m	Length of the cold arm, thin part
htc_s	$0.04 [W / (m * K)] / 2 [\mu m]$	20000 W/(m <sup>2</sup> *K)	Heat transfer coefficient
htc_us	$0.04 [W / (m * K)] / 100 [\mu m]$	400 W/(m <sup>2</sup> *K)	Heat transfer coefficient, upper surface
DV	5[V]	5 V	Applied voltage

## GEOMETRY I



*Work Plane 1 (wp1)*

- 1 In the **Geometry** toolbar, click  **Work Plane**.
- 2 In the **Settings** window for **Work Plane**, click  **Build Selected**.
- 3 Click  **Show Work Plane**.



*Work Plane 1 (wp1)>Rectangle 1 (r1)*

- 1 In the **Work Plane** toolbar, click  **Rectangle**.
- 2 In the **Settings** window for **Rectangle**, locate the **Size and Shape** section.
- 3 In the **Width** text field, type L3.
- 4 In the **Height** text field, type dw.
- 5 Locate the **Position** section. In the **xw** text field, type L-L3.
- 6 Click  **Build Selected**.



*Work Plane 1 (wp1)>Rectangle 2 (r2)*

- 1 In the **Work Plane** toolbar, click  **Rectangle**.
- 2 In the **Settings** window for **Rectangle**, locate the **Size and Shape** section.
- 3 In the **Width** text field, type L4.
- 4 In the **Height** text field, type d.
- 5 Locate the **Position** section. In the **xw** text field, type L-L3-L4.
- 6 In the **yw** text field, type dw-d.
- 7 Click  **Build Selected**.
- 8 Click the  **Zoom Extents** button in the **Graphics** toolbar.



*Work Plane 1 (wp1)>Rectangle 3 (r3)*

- 1 In the **Work Plane** toolbar, click  **Rectangle**.
- 2 In the **Settings** window for **Rectangle**, locate the **Size and Shape** section.
- 3 In the **Width** text field, type  $wb$ .
- 4 In the **Height** text field, type  $dw$ .
- 5 Locate the **Position** section. In the **xw** text field, type  $L-L3-L4-wb$ .
- 6 Click  **Build Selected**.
- 7 Click the  **Zoom Extents** button in the **Graphics** toolbar.

*Work Plane 1 (wp1)>Rectangle 4 (r4)*

- 1 In the **Work Plane** toolbar, click  **Rectangle**.
- 2 In the **Settings** window for **Rectangle**, locate the **Size and Shape** section.
- 3 In the **Width** text field, type  $L2$ .
- 4 In the **Height** text field, type  $d$ .
- 5 Locate the **Position** section. In the **xw** text field, type  $L-L2$ .
- 6 In the **yw** text field, type  $dw+gap$ .
- 7 Click  **Build Selected**.

*Work Plane 1 (wp1)>Rectangle 5 (r5)*

- 1 In the **Work Plane** toolbar, click  **Rectangle**.
- 2 In the **Settings** window for **Rectangle**, locate the **Size and Shape** section.
- 3 In the **Width** text field, type  $wb$ .
- 4 In the **Height** text field, type  $dw+gap+d$ .
- 5 Locate the **Position** section. In the **xw** text field, type  $L-L2-wb$ .
- 6 Click  **Build Selected**.
- 7 Click the  **Zoom Extents** button in the **Graphics** toolbar.

*Work Plane 1 (wp1)>Rectangle 6 (r6)*

- 1 In the **Work Plane** toolbar, click  **Rectangle**.
- 2 In the **Settings** window for **Rectangle**, locate the **Size and Shape** section.
- 3 In the **Width** text field, type  $L1$ .
- 4 In the **Height** text field, type  $d$ .
- 5 Locate the **Position** section. In the **xw** text field, type  $L-L1$ .
- 6 In the **yw** text field, type  $dw+d+2*gap$ .



7 Click  **Build Selected**.

8 Click the  **Zoom Extents** button in the **Graphics** toolbar.

*Work Plane 1 (wp1)>Rectangle 7 (r7)*

1 In the **Work Plane** toolbar, click  **Rectangle**.

2 In the **Settings** window for **Rectangle**, locate the **Size and Shape** section.

3 In the **Width** text field, type `wb`.

4 In the **Height** text field, type `dw+gap+d`.

5 Locate the **Position** section. In the **yw** text field, type `dw+d+2*gap`.

6 Click  **Build Selected**.

7 Click the  **Zoom Extents** button in the **Graphics** toolbar.

*Work Plane 1 (wp1)>Rectangle 8 (r8)*

1 In the **Work Plane** toolbar, click  **Rectangle**.

2 In the **Settings** window for **Rectangle**, locate the **Size and Shape** section.

3 In the **Width** text field, type `d`.

4 In the **Height** text field, type `gap`.

5 Locate the **Position** section. In the **xw** text field, type `L-d`.

6 In the **yw** text field, type `dw+gap+d`.

7 Click  **Build Selected**.

*Work Plane 1 (wp1)>Rectangle 9 (r9)*

1 In the **Work Plane** toolbar, click  **Rectangle**.

2 In the **Settings** window for **Rectangle**, locate the **Size and Shape** section.

3 In the **Width** text field, type `d`.

4 In the **Height** text field, type `gap`.

5 Locate the **Position** section. In the **xw** text field, type `L-d`.

6 In the **yw** text field, type `dw`.

7 Click  **Build Selected**.

*Work Plane 1 (wp1)>Union 1 (uni1)*

1 In the **Work Plane** toolbar, click  **Booleans and Partitions** and choose **Union**.

2 Click in the **Graphics** window and then press `Ctrl+A` to select all objects.

3 In the **Settings** window for **Union**, locate the **Union** section.

4 Clear the **Keep interior boundaries** check box.

5 Click  **Build Selected**.

*Work Plane 1 (wp1)>Fillet 1 (fil1)*

1 In the **Work Plane** toolbar, click  **Fillet**.

2 In the **Settings** window for **Fillet**, locate the **Radius** section.

3 In the **Radius** text field, type  $d/3$ .

4 On the object **uni1**, select Points 1, 2, 4–9, 11–14, 16, 17, 19–23, and 28 only.

It might be easier to select the points by using the **Selection List** window. To open this window, in the **Home** toolbar click **Windows** and choose **Selection List**. (If you are running the cross-platform desktop, you find **Windows** in the main menu.)

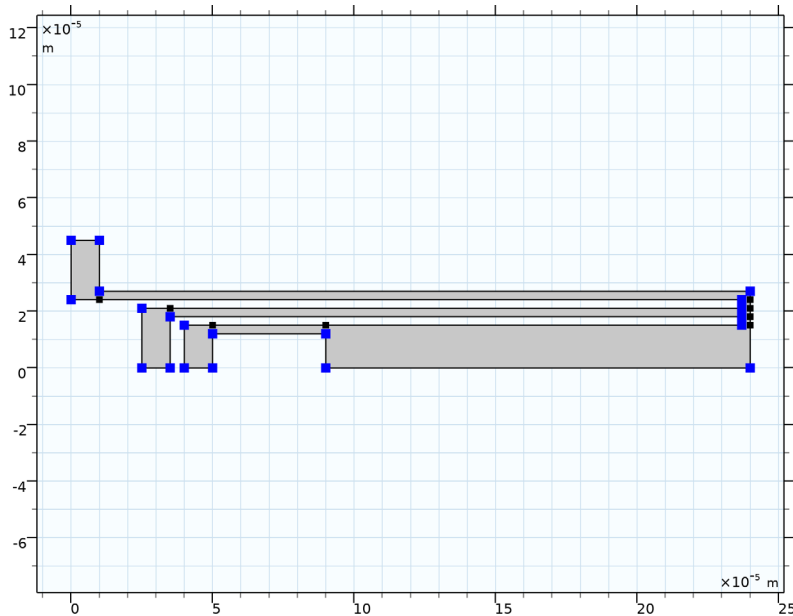

5 Click  **Build Selected**.

*Extrude 1 (ext1)*

1 In the **Model Builder** window, under **Thermal Actuator (comp1)>Geometry 1** right-click **Work Plane 1 (wp1)** and choose **Extrude**.



2 In the **Settings** window for **Extrude**, locate the **Distances** section.

3 In the table, enter the following settings:

<b>Distances (m)</b>
$2e-6$

- 4 Click  **Build Selected**.
- 5 Click the  **Go to Default View** button in the **Graphics** toolbar.



*Work Plane 2 (wp2)*

- 1 In the **Geometry** toolbar, click  **Work Plane**.
- 2 In the **Settings** window for **Work Plane**, click  **Build Selected**.
- 3 Click  **Show Work Plane**.



*Work Plane 2 (wp2)>Plane Geometry*

Click the  **Zoom Extents** button in the **Graphics** toolbar.

*Work Plane 2 (wp2)>Rectangle 1 (r1)*

- 1 In the **Work Plane** toolbar, click  **Rectangle**.
- 2 In the **Settings** window for **Rectangle**, locate the **Size and Shape** section.
- 3 In the **Width** text field, type  $wb - 2 * d$ .
- 4 In the **Height** text field, type  $2.5 * (wb - 2 * d)$ .
- 5 Locate the **Position** section. In the **xw** text field, type  $d$ .
- 6 In the **yw** text field, type  $(dw + d + 2 * gap) + (dw + gap + d) - 2.5 * (wb - 2 * d) - d$ .
- 7 Click  **Build Selected**.

*Work Plane 2 (wp2)>Rectangle 2 (r2)*



- 1 In the **Work Plane** toolbar, click  **Rectangle**.
- 2 In the **Settings** window for **Rectangle**, locate the **Size and Shape** section.
- 3 In the **Width** text field, type  $wb - 2 * d$ .
- 4 In the **Height** text field, type  $2.5 * (wb - 2 * d)$ .
- 5 Locate the **Position** section. In the **xw** text field, type  $L - L2 - wb + d$ .
- 6 In the **yw** text field, type  $d$ .
- 7 Click  **Build Selected**.

*Work Plane 2 (wp2)>Rectangle 3 (r3)*

- 1 In the **Work Plane** toolbar, click  **Rectangle**.
- 2 In the **Settings** window for **Rectangle**, locate the **Size and Shape** section.
- 3 In the **Width** text field, type  $wb - 2 * d$ .
- 4 In the **Height** text field, type  $2.5 * (wb - 2 * d)$ .
- 5 Locate the **Position** section. In the **xw** text field, type  $L - L3 - L4 - wb + d$ .
- 6 In the **yw** text field, type  $d$ .

7 Click  **Build Selected**.

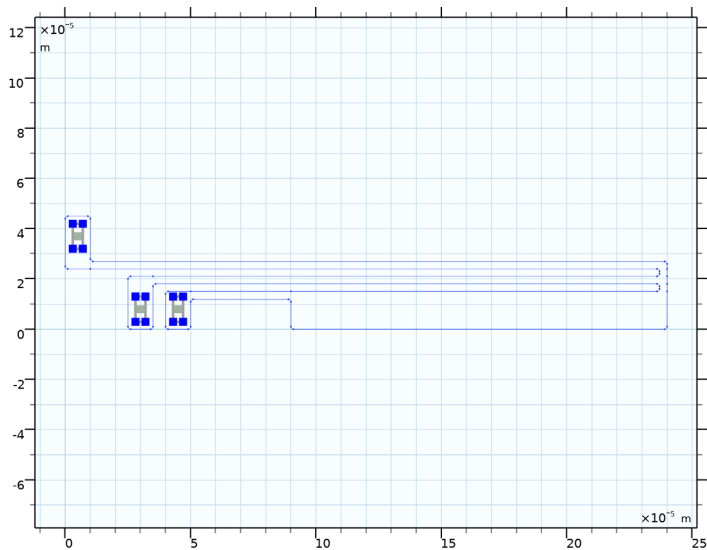

*Work Plane 2 (wp2)>Fillet 1 (fil1)*

- 1 In the **Work Plane** toolbar, click  **Fillet**.
- 2 In the **Settings** window for **Fillet**, locate the **Radius** section.
- 3 In the **Radius** text field, type  $d/3$ .
- 4 Select all four vertices for all three rectangles as follows:
- 5 Click the  **Select Box** button in the **Graphics** toolbar.
- 6 In the **Graphics** window, draw a box encompassing the three rectangles you just created, then right-click to confirm the selection.





7 Click  **Build Selected**.



*Work Plane 2 (wp2)>Circle 1 (c1)*

- 1 In the **Work Plane** toolbar, click  **Circle**.
- 2 In the **Settings** window for **Circle**, locate the **Size and Shape** section.
- 3 In the **Radius** text field, type  $d/2$ .
- 4 Locate the **Position** section. In the **xw** text field, type  $L - L3/4$ .
- 5 In the **yw** text field, type  $dw/2$ .
- 6 Click  **Build Selected**.

*Work Plane 2 (wp2)>Circle 2 (c2)*

- 1 In the **Work Plane** toolbar, click  **Circle**.
- 2 In the **Settings** window for **Circle**, locate the **Size and Shape** section.
- 3 In the **Radius** text field, type  $d/2$ .
- 4 Locate the **Position** section. In the **xw** text field, type  $L-L3/2$ .
- 5 In the **yw** text field, type  $dw/2$ .
- 6 Click  **Build Selected**.

*Work Plane 2 (wp2)>Circle 3 (c3)*

- 1 In the **Work Plane** toolbar, click  **Circle**.
- 2 In the **Settings** window for **Circle**, locate the **Size and Shape** section.
- 3 In the **Radius** text field, type  $d/2$ .
- 4 Locate the **Position** section. In the **xw** text field, type  $L-3*L3/4$ .
- 5 In the **yw** text field, type  $dw/2$ .
- 6 Click  **Build Selected**.



*Extrude 2 (ext2)*

- 1 In the **Model Builder** window, under **Thermal Actuator (comp1)>Geometry 1** right-click **Work Plane 2 (wp2)** and choose **Extrude**.
- 2 In the **Settings** window for **Extrude**, locate the **Distances** section.
- 3 In the table, enter the following settings:

<b>Distances (m)</b>
$2e-6$



- 4 Select the **Reverse direction** check box.
- 5 Click  **Build Selected**.

*Union 1 (uni1)*

- 1 In the **Geometry** toolbar, click  **Booleans and Partitions** and choose **Union**.
- 2 Click the  **Zoom Extents** button in the **Graphics** toolbar.
- 3 Click in the **Graphics** window and then press **Ctrl+A** to select both objects.
- 4 In the **Settings** window for **Union**, click  **Build All Objects**.

## DEFINITIONS

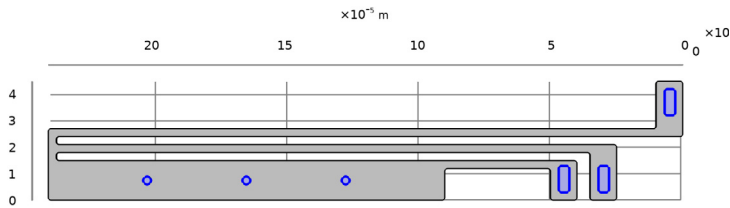

*substrate contact*

- 1 In the **Definitions** toolbar, click  **Explicit**.
- 2 In the **Settings** window for **Explicit**, locate the **Input Entities** section.
- 3 From the **Geometric entity level** list, choose **Boundary**.
- 4 Select Boundaries 10, 30, 50, 70, 76, and 82 only.
- 5 Click the  **Go to XY View** button in the **Graphics** toolbar three times to view the geometry from below.



- 6 In the **Label** text field, type `substrate contact`.

## ADD MATERIAL

- 1 In the **Home** toolbar, click  **Add Material** to open the **Add Material** window.
- 2 Go to the **Add Material** window.
- 3 In the tree, select **MEMS>Semiconductors>Si - Polycrystalline silicon**.
- 4 Click **Add to Component** in the window toolbar.
- 5 In the **Home** toolbar, click  **Add Material** to close the **Add Material** window.

## MATERIALS

### *Si - Polycrystalline silicon (mat1)*

By default, the first material you add applies on all domains so you can keep the **Geometric Entity Selection** settings.

- 1 In the **Settings** window for **Material**, locate the **Material Contents** section.
- 2 In the table, enter the following settings:

Property	Variable	Value	Unit	Property group
Electrical conductivity	sigma_iso ; sigma <sub>ii</sub> = sigma_iso, sigma <sub>ij</sub> = 0	5e4	S/m	Basic

## SOLID MECHANICS (SOLID)

### *Fixed Constraint 1*

- 1 In the **Model Builder** window, under **Thermal Actuator (comp1)** right-click **Solid Mechanics (solid)** and choose **Fixed Constraint**.
- 2 Select Boundaries 10, 30, and 50 only.

### *Roller 1*

- 1 In the **Physics** toolbar, click  **Boundaries** and choose **Roller**.
- 2 Select Boundaries 70, 76, and 82 only.

## HEAT TRANSFER IN SOLIDS (HT)

In the **Model Builder** window, under **Thermal Actuator (comp1)** click **Heat Transfer in Solids (ht)**.

### *Heat Flux 1*

- 1 In the **Physics** toolbar, click  **Boundaries** and choose **Heat Flux**.

This boundary condition applies to all boundaries except the top-surface boundary and those in contact with the substrate. A **Temperature** condition on the substrate contact boundaries will override this **Heat Flux** condition so you do not explicitly need to exclude those boundaries. In contrast, because the **Heat Flux** boundary condition is additive, you must explicitly exclude the top-surface boundary from the selection.

Implement this selection as follows:

- 2 In the **Settings** window for **Heat Flux**, locate the **Boundary Selection** section.

- 3 From the **Selection** list, choose **All boundaries**.
- 4 In the **Graphics** window, click on the top surface and then right-click to remove it from the selection.  
A convective heat flux is used to model the heat flux through a thin air layer. The heat transfer coefficient,  $h_{tc\_s}$  is defined as the ratio of the air thermal conductivity to the gap thickness.
- 5 Locate the **Heat Flux** section. From the **Flux type** list, choose **Convective heat flux**.
- 6 In the  $h$  text field, type  $h_{tc\_s}$ .

#### *Heat Flux 2*

- 1 In the **Physics** toolbar, click  **Boundaries** and choose **Heat Flux**.
- 2 Select Boundary 4 only.  
A convective heat flux is used to model the heat flux through a thin air layer. The heat transfer coefficient,  $h_{tc\_us}$  is defined as the ratio of the air thermal conductivity to the gap thickness.
- 3 In the **Settings** window for **Heat Flux**, locate the **Heat Flux** section.
- 4 From the **Flux type** list, choose **Convective heat flux**.
- 5 In the  $h$  text field, type  $h_{tc\_us}$ .

#### *Temperature 1*

- 1 In the **Physics** toolbar, click  **Boundaries** and choose **Temperature**.
- 2 In the **Settings** window for **Temperature**, locate the **Boundary Selection** section.
- 3 From the **Selection** list, choose **substrate contact**.

### **ELECTRIC CURRENTS (EC)**

In the **Model Builder** window, under **Thermal Actuator (comp1)** click **Electric Currents (ec)**.

#### *Ground 1*

- 1 In the **Physics** toolbar, click  **Boundaries** and choose **Ground**.
- 2 Select Boundary 10 only.

#### *Electric Potential 1*

- 1 In the **Physics** toolbar, click  **Boundaries** and choose **Electric Potential**.
- 2 Select Boundary 30 only.
- 3 In the **Settings** window for **Electric Potential**, locate the **Electric Potential** section.
- 4 In the  $V_0$  text field, type  $DV$ .



## MESH I

### *Free Tetrahedral I*

In the **Mesh** toolbar, click  **Free Tetrahedral**.

### *Size I*

Right-click **Free Tetrahedral I** and choose **Size**.

### *Size*

- 1 In the **Settings** window for **Size**, locate the **Element Size** section.
- 2 From the **Predefined** list, choose **Fine**.
- 3 Click the **Custom** button.
- 4 Locate the **Element Size Parameters** section. In the **Maximum element growth rate** text field, type 1.2.

This setting makes the mesh more robust for parametric sweeps over the geometry length parameter L.

### *Size I*

- 1 In the **Model Builder** window, under **Thermal Actuator (comp1)>Mesh I>Free Tetrahedral I** click **Size I**.
- 2 In the **Settings** window for **Size**, locate the **Element Size** section.
- 3 From the **Predefined** list, choose **Finer**.
- 4 Locate the **Geometric Entity Selection** section. From the **Geometric entity level** list, choose **Boundary**.
- 5 Select Boundaries 86–91 only.
- 6 Click  **Build All**.

## STUDY I

### *Step 1: Stationary*



- 1 In the **Model Builder** window, under **Study I** click **Step 1: Stationary**.
- 2 In the **Settings** window for **Stationary**, locate the **Study Settings** section.
- 3 Select the **Include geometric nonlinearity** check box.
- 4 In the **Home** toolbar, click  **Compute**.

## RESULTS

### *Stress (solid)*

The first default plot show the von Mises stress.

### *Volume 1*

- 1 In the **Model Builder** window, expand the **Stress (solid)** node, then click **Volume 1**.
- 2 In the **Settings** window for **Volume**, locate the **Expression** section.
- 3 From the **Unit** list, choose **MPa**.
- 4 In the **Stress (solid)** toolbar, click  **Plot**.
- 5 Click the  **Zoom Extents** button in the **Graphics** toolbar.

### *Temperature (ht)*

- 1 Click the  **Go to Default View** button in the **Graphics** toolbar.

The second default plot shows the temperature field.

Create a new plot for displacement.

### *Displacement*

- 1 In the **Home** toolbar, click  **Add Plot Group** and choose **3D Plot Group**.
- 2 In the **Settings** window for **3D Plot Group**, type Displacement in the **Label** text field.

### *Surface 1*

- 1 Right-click **Displacement** and choose **Surface**.
- 2 In the **Settings** window for **Surface**, locate the **Expression** section.
- 3 From the **Unit** list, choose  $\mu\text{m}$ .
- 4 Locate the **Coloring and Style** section. Click  **Change Color Table**.
- 5 In the **Color Table** dialog box, select **Rainbow>SpectrumLight** in the tree.
- 6 Click **OK**.

### *Deformation 1*

- 1 Right-click **Surface 1** and choose **Deformation**.
- 2 In the **Displacement** toolbar, click  **Plot**.